

# OADM 20I5570/S14C

Laser Distanz Sensor

Laser distance sensor

Détecteur laser de distance



11164060



Baumer Electric AG · CH-8501 Frauenfeld  
Phone +41 (0)52 728 1122 · Fax +41 (0)52 728 1144

## Abmessungen

## Dimensions

## Dimensions

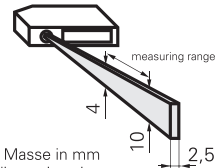
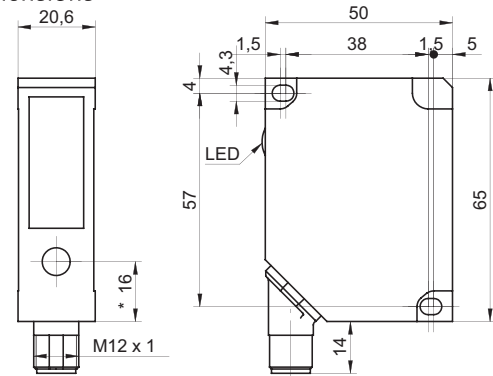

- Alle Masse in mm
- All dimensions in mm
- Toutes dimensions en mm
- \* Senderachse
- \* Emitter axis
- \* Axe de l'émetteur

## Elektrischer Anschluss

## Connection diagram

## Schéma de raccordement

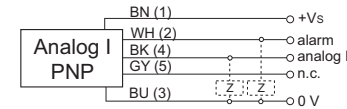

BN = Braun/brown/brun  
WH = Weiss/white/blanc  
BK = Schwarz/black/noir  
BU = Blau/blue/bleu  
GY = Grau/grey/gris

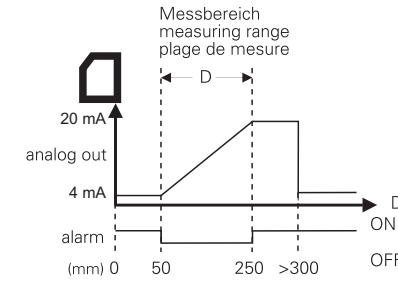
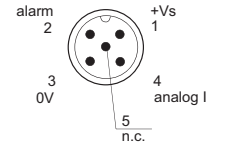

**Canada**  
Baumer Inc.  
CA-Burlington, ON L7M 4B9  
Phone +1 (1)905 335-8444

**Italy**  
Baumer Italia S.r.l.  
IT-20090 Assago, MI  
Phone +39 (0)2 45 70 60 65

**China**  
Baumer (China) Co., Ltd.  
CN-201612 Shanghai  
Phone +86 (0)21 6768 7095

**Singapore**  
Baumer (Singapore) Pte. Ltd.  
SG-339412 Singapore  
Phone +65 6396 4131

**Denmark**  
Baumer A/S  
DK-8210 Aarhus V  
Phone +45 (0)8931 7611

**Sweden**  
Baumer A/S  
SE-56133 Huskvarna  
Phone +46 (0)36 13 94 30

**France**  
Baumer SAS  
FR-74250 Fillinges  
Phone +33 (0)450 392 466

**Switzerland**  
Baumer Electric AG  
CH-8501 Frauenfeld  
Phone +41 (0)52 728 1313

**Germany**  
Baumer GmbH  
DE-61169 Friedberg  
Phone +49 (0)6031 60 07 0

**United Kingdom**  
Baumer Ltd.  
GB-Watchfield, Swindon, SN6 8TZ  
Phone +44 (0)1793 783 839

**India**  
Baumer India Private Limited  
IN-411038 Pune  
Phone +91 20 2528 6833/34

**USA**  
Baumer Ltd.  
US-Southington, CT 06489  
Phone +1 (1)860 621-2121

## Allg. Sicherheitsbestimmungen

## General safety instructions

## Instructions générales de sécurité



Laserstrahl nie auf ein Auge richten.  
Es empfiehlt sich, den Strahl nicht ins Leere  
laufen zu lassen, sondern mit einem matten  
Blech oder Gegenstand zu stoppen.

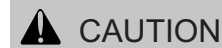

Do not point the laser beam towards  
someone's eye. It is recommended to  
stop the beam by a mat object or mat  
metal sheet.



Ne dirigez jamais le faisceau vers un oeil.  
Il est conseillé de ne pas laisser le faisceau  
se propager librement mais de l'arrêter au  
moyen d'un objet de surface mate.

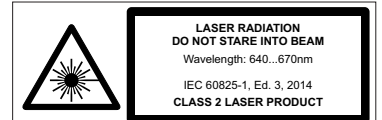

Complies with 21 CFR 1040.10 and 1040.11  
except for conformance with IEC 60825-1 Ed. 3.,  
as described in Laser Notice No. 56, dated May 8, 2019

- Aus Lasersicherheitsgründen muss die Spannungsversorgung dieses Sensors abgeschaltet werden, wenn die ganze Anlage oder Maschine abgeschaltet wird.
- Laser regulations require the power of the sensor to be switched off when turning off the whole system this sensor is part of.
- Pour des raisons de sécurité, l'alimentation de ce détecteur laser doit être coupée en cas d'arrêt total du système incorporant ce détecteur.

Technische Daten  
 Technical data  
 Données techniques

# OADM 20I5570/S14C

Messbereich	Measuring range	Plage de mesure	50...250 mm
Auflösung (matt weisse Keramik)	Resolution (matte white ceramic)	Résolution (céramique blanche mate)	0,3 mm
Linearitätsabweichung (matt weisse Keramik)	Linearity error (matte white ceramic)	Déviation de linéarité (céramique blanche mate)	± 0,9 mm
Lichtquelle	Light source	Source de lumière	LASER Diode red, pulsed
Laserklasse / Wellenlänge	Laser class / Wave length	Classe laser / Longueur d'onde	2 / 650 nm
Ansprechzeit	Response time	Temps d'activation	< 10 ms
Analogausgang	Analog output	Sortie analogique	4...20 mA
Alarmausgang	Alarm output	Sortie alarme	PNP
max. Schaltstrom	max. switching current	max. courant de commutation	100 mA
Alarm / Verschmutzungsanzeige	Alarm / Soiled lens indicator	Alarme / Contrôle d'encrassement	red LED / flashing red LED
Betriebsanzeige	Power indicator	Affichage de fonctionnement	green LED
Betriebsspannungsbereich Vs (UL-Class 2)	Voltage supply range Vs (UL-Class 2)	Plage de tension Vs (UL-Class 2)	12 - 28 VDC
max. Stromverbrauch	max. supply current	max. consommation	< 120 mA
Kurzschlussfest	Short circuit protection	Protégé contre courts-circuits	ja / yes / oui
Verpolungsfest	Reverse polarity protection	Protégé contre inversion de polarité	ja / yes / oui <sup>∇</sup>
Arbeitstemperaturbereich	Operating temperature range	Température de service	0...50 °C
Schutzklasse	Protection class	Classe de protection	IP67

∇ Nur Betriebsspannung / voltage supply only / plage tension

## Montage und Justage

### Mounting

### Montage

Hinweis zur Elektromagnetischen Verträglichkeit:  
 Geschirmtes Anschlusskabel empfohlen. Kabelschirm  
 beidseitig, grossflächig erden und Potentialausgleich sicherstellen.

Note to electromagnetic compatibility:  
 A shielded cable is recommended. Cable shielding on both ends,  
 grounding over a large area and ensure potential equalization.

Note à la compatibilité électromagnétique:  
 Un câble blindé est recommandé. Blindage du câble aux deux  
 extrémités, la terre sur une grande surface et à assurer l'égalité  
 potentiel.

Stufen  
 Steps  
 Gradin

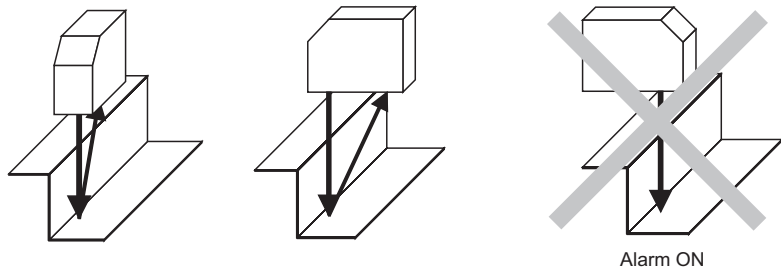

Runde, glänzende Oberflächen  
 Round glossy surfaces  
 Surface ronde brillante

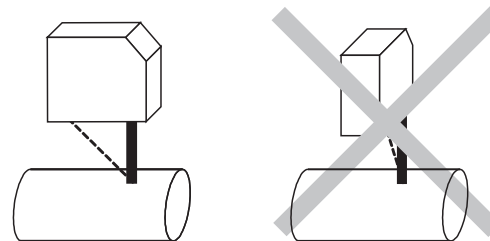

Glänzende Oberflächen  
 Glossy surfaces  
 Surface brillante

