

O300H.SP-11127754

SmartReflect Lichtschranken

SmartReflect Light barriers

Barrières SmartReflect



11127754



Baumer Electric AG · CH-8501 Frauenfeld
Phone +41 (0)52 728 1122 · Fax +41 (0)52 728 1144

Canada
Baumer Inc.
CA-Burlington, ON L7M 4B9
Phone +1 (1)905 335-8444

China
Baumer (China) Co., Ltd.
CN-201612 Shanghai
Phone +86 (0)21 6768 7095

Denmark
Baumer A/S
DK-8210 Aarhus V
Phone +45 (0)8931 7611

France
Baumer SAS
FR-74250 Fillinges
Phone +33 (0)450 392 466

Germany
Baumer GmbH
DE-61169 Friedberg
Phone +49 (0)6031 60 07 0

India
Baumer India Private Limited
IN-411038 Pune
Phone +91 20 2528 6833/34

Italy
Baumer Italia S.r.l.
IT-20090 Assago, MI
Phone +39 (0)2 45 70 60 65

Singapore
Baumer (Singapore) Pte. Ltd.
SG-339412 Singapore
Phone +65 6396 4131

Sweden
Baumer A/S
SE-56133 Huskvarna
Phone +46 (0)36 13 94 30

Switzerland
Baumer Electric AG
CH-8501 Frauenfeld
Phone +41 (0)52 728 1313

United Kingdom
Baumer Ltd.
GB-Watchfield, Swindon, SN6 8TZ
Phone +44 (0)1793 783 839

USA
Baumer Ltd.
US-Southington, CT 06489
Phone +1 (1)860 621-2121

Abmessungen Dimensions Dimensions

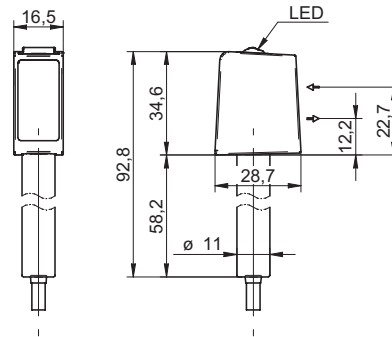

- Alle Maße in mm
- All dimensions in mm
- Toutes les dimensions en mm

Elektrischer Anschluss Connection diagram Schéma de raccordement

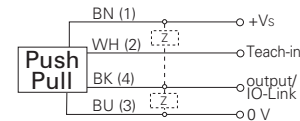

BN = Braun/brown/brun
WH = Weiss/white/blanc
BK = Schwarz/black/noir
BU = Blau/blue/bleu

¹⁾ Class 2, UL 1310, see FAQ

- Vor dem Anschliessen des Sensors die Anlage spannungsfrei schalten.
- Disconnect power before connecting the sensor.
- Mettre l'installation hors tension avant le raccordement du détecteur.

Technische Daten

Technical data

Données techniques

Hintergrundposition Sde	30 ... 300 mm	background position Sde	30 ... 300 mm	Position de l'arrière plan Sde	30 ... 300 mm
Erfassungsbereich Sa	90% ... 85% Sde	scanning range sa	90% ... 85% Sde	Plage de détection Sa	90% ... 85% Sde
Ausrichtung optische Achse	< 2°	alignment optical axis	< 2°	Axe d'alignement optique	< 2°
Betriebsspannungsbereich +Vs ¹⁾	10 ... 30 VDC	voltage supply range +Vs ¹⁾	10 ... 30 VDC	Plage de tension +Vs ¹⁾	10 ... 30 VDC
Stromaufnahme max. (ohne Last)	45 mA	current consumption max. (no load)	45 mA	Consommation max. (sans charge)	45 mA
Stromaufnahme mittel	30 mA	current consumption typ.	30 mA	Courant absorbé moyen	30 mA
Spannungsabfall Vd	< 3 VDC	voltage drop Vd	< 3 VDC	Tension résiduelle Vd	< 3 VDC
Ansprech- / Abfallzeit	< 0,49 ms	response time / release time	< 0,49 ms	Temps d'activation / désactivation	< 0,49 ms
Ausgangsschaltung	Gegentakt	output circuit	push-pull	Circuit de sortie	push-pull
Schaltfunktion	Hell- / Dunkel-schaltung	output function	light / dark operate	Fonction de commutation	claire/sombre
kurzschlussfest	ja	short circuit protection	yes	Protégé contre courts-circuits	oui
verpolungsfest	ja	reverse polarity protection	yes	Protégé contre inversion polarité	oui
Arbeitstemperatur	-25 ... +60 °C	operating temperature	-25 ... +60 °C	Température de fonctionnement	-25 ... +60 °C
Schutzart	IP 68/69K & proTect+	protection class	IP 68/69K & proTect+	Classe de protection	IP 68/69K & proTect+

qTeach Status

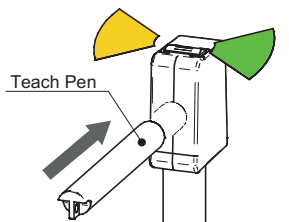

Kurzes antippen
Tap shortly
Touche brièvement

Allgemeine Hinweise

- qTeach verriegelt 5 min nach dem Einschalten.
- Im Teachmodus wechselt der Ausgang in den nichtgeschalteten Zustand.
- Im Normalbetrieb muss die Teachleitung auf 0 V gelegt werden.
- Für externes Teach-in, Teachleitung entsprechend mit Vs+ verbinden.

General information

- qTeach locks 5 min after switching-on.
- In teach mode the output changes to the non-switched state.
- In normal mode the teach wire is set to 0 V.
- For external teach-in, connect teach wire correspondingly to Vs+.

Remarques générales

- qTeach se verrouille 5 min après l'enclenchement.
- En mode Teach, la sortie dans l'état non commutée.
- En fonctionnement normal, la connexion Teach doit être placée sur 0 V.
- Pour le Teach-in externe, raccorder en conséquence la connexion sur Vs+.

Teach 1-Punkt Teach 1-point teach Teach à 1 point

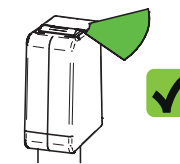
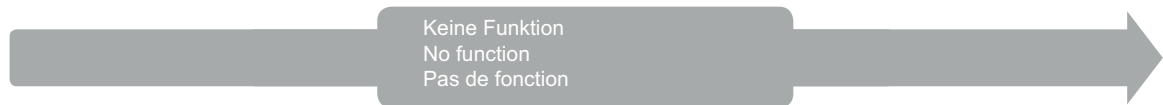
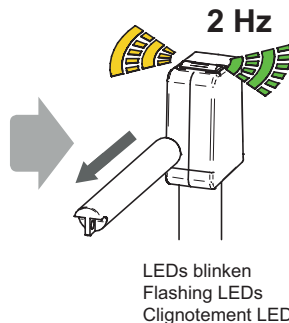
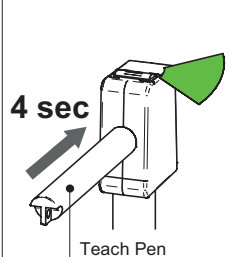
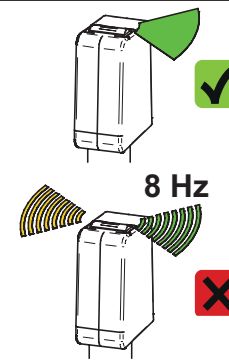
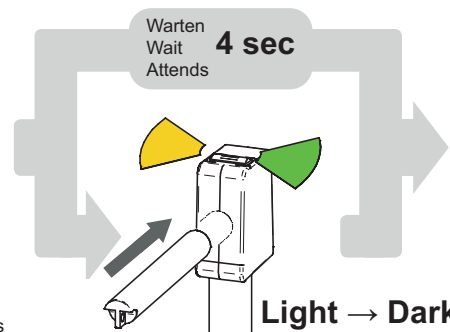
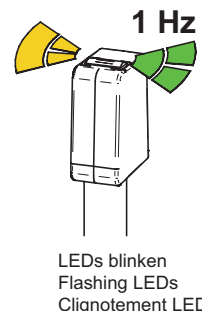
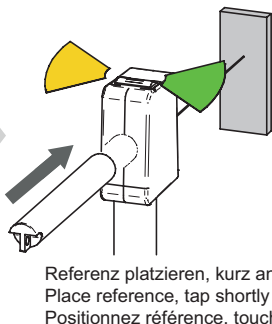
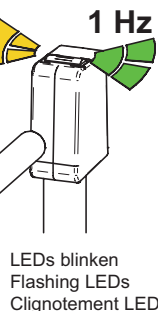
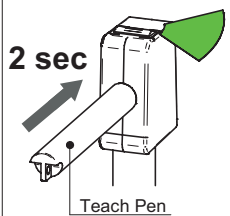

Justierhilfe Adjusting aid Aide à l'ajustement

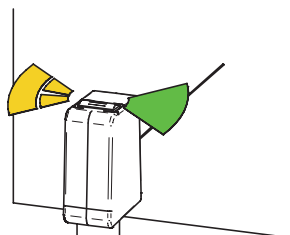
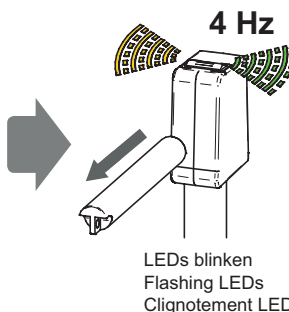
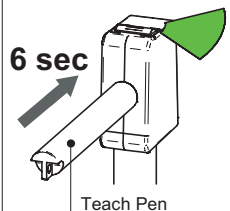

Signalstärke
Signal power
La force du signal

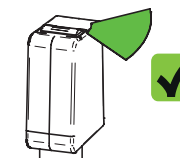
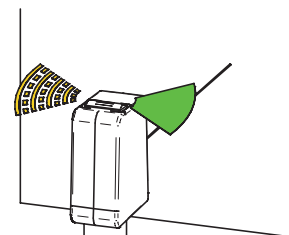

Sensor ausrichten, schnelleres blinken, besserer Empfang
Align sensor, faster flashing, better reception
Aligner le capteur, clignotent rapidement, il meilleure réception

O300H.SP-11127754

Blinkmodi Flashing modes Modes de clignotement

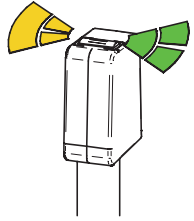

Blinken 1 Hz
Flashing 1 Hz
Clignotement 1 Hz

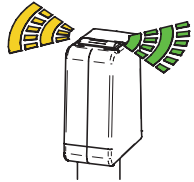

Blinken 2 Hz
Flashing 2 Hz
Clignotement 2 Hz

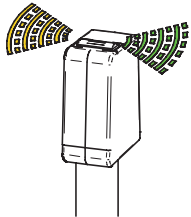

Blinken 4 Hz
Flashing 4 Hz
Clignotement 4 Hz

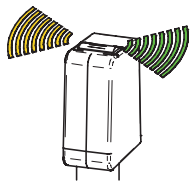

Blinken 8 Hz
Flashing 8 Hz
Clignotement 8 Hz

Farben LED Colors LED Couleurs LED

Gelb
Yellow
Jaune

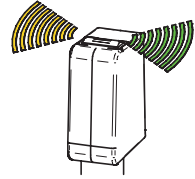

Grün
Green
Vert

LED Anzeigen LED indication Indication LED

Grün: Betriebsanzeige, Kurzschluss
Green: Operating indication, short circuit
Vert: Signalisation de service, court-circuit

Gelb: Lichtempfang, Teach Rückmeldung
Yellow: Light reception, Teach feedback
Jaune: Réception de lumière, retour teach

Zubehör Accessories Accessoires

Befestigungs-Kit HI11-1H
Mounting kit HI11-1H
Kit de montage HI11-1H
11039552

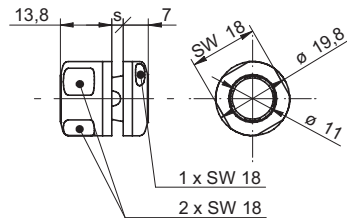

S = 1.5 ... 6.5 mm

Montage Mounting Montage

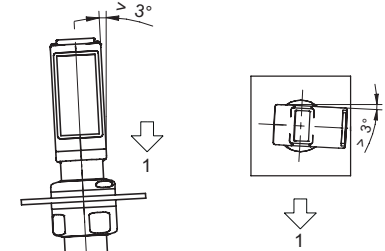
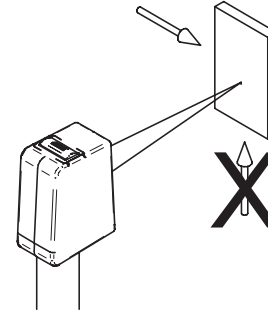

1 Richtung der Schwerkraft
1 Direction of gravity
1 Sens de la gravité

Reinigungshinweis: Während jedes Reinigungsvorgangs muss die im Datenblatt angegebene maximale Arbeitstemperatur berücksichtigt werden. Der Sensor darf mit einem Wasserstrahl entsprechend der IP 69K Richtlinien gereinigt werden. Die im Sensor verwendeten Materialien sind höchst chemiebeständig gegen eine grosse Auswahl von Säuren, Basen und Alkoholen. Es liegt in der Verantwortung des Benutzers, die chemische Resistenz des Sensors gegen die genutzten Reinigungsmittel vor der Reinigung zu überprüfen. Weitere Informationen auf der Website des Herstellers: www.baumer.com

Important hints on applicable cleaning procedures: During any cleaning operation the maximum working temperature, as shown in the specification sheet, must be taken into account. The sensor may be cleaned by applying a water jet as specified in the IP69K sealing guidelines. The sensor materials are highly chemically resistant against a wide range of acids, bases and alcohols. It is the user's responsibility to verify the chemical resistance of the sensor against the cleaning materials used prior to cleaning. For further information please visit the product website at: www.baumer.com

Indication pour le nettoyage: Pendant chaque processus de nettoyage, il faut tenir compte de la température maximale de travail mentionnée sur la fiche technique. Le détecteur peut être nettoyé au jet d'eau sous pression selon les directives IP69K. Les matériaux utilisés lors de la fabrication du détecteur sont extrêmement résistants à un grand nombre d'acides, de bases et d'alcools. Avant de procéder aux opérations de nettoyage, il appartient à l'utilisateur de contrôler la résistance chimique du détecteur par rapport au produit de nettoyage utilisé. Vous trouverez de plus amples informations sur le site du fabricant: www.baumer.com

Teach Pen
Teach Pen
Teach Pen
11137318

Teach Pen (USA CAN JP)
Teach Pen (USA CAN JP)
Teach Pen (USA CAN JP)
11141124

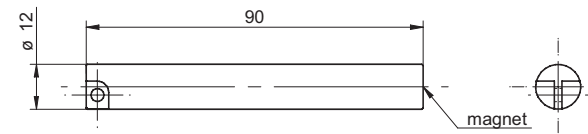

FAQ

• Was bedeutet Light -> Dark?

Hell-/Dunkel Umschaltung des Sensors.

• Wie funktioniert der qTeach via Leitung?

Identisch zum qTeach, indem die Teachleitung entsprechend mit Vs+ verbunden wird. Der qTeach via Leitung ist jeder Zeit möglich und muss daher manuell verriegelt werden (Leitung auf 0V).

• Was bedeutet das Fehlerblinker (8 Hz) nach dem Einlernen?

- Signalreserve ungenügend; das eingelernte Referenzobjekt, reflektiert zu wenig Licht
- Der Sensor wurde ausserhalb seines Einstellbereichs eingelernt

• Netzteil nach UL 1310, Class 2?

oder externe Absicherung durch eine UL anerkannte oder gelistete Sicherung mit max. 30VAC/3A oder 24VDC/4A.

• What does Light -> Dark mean?

Light/dark switching of the sensor.

• How does qTeach via wire work?

In the same manner as qTeach, by connecting the teach wire correspondingly to Vs+. The qTeach via wire works any time, therefore it has to be locked manually (wire to 0V).

• What does error flashing (8 Hz) after teach-in mean?

- Excess gain insufficient; the taught-in reference object does not reflect enough light
- The sensor is taught-in outside of its adjusting range.

• Voltage supply according UL 1310, Class2?

or device shall be protected by an external R/C or listed fuse, rated max. 30VAC/3A or 24VDC/4A.

• Que signifie Light -> Dark?

Commutation claire/sombre du détecteur.

• Comment fonctionne le qTeach via la connexion?

Exactement comme avec qTeach, en raccordant la connexion Teach à Vs+. Le qTeach via la connexion est possible à tout moment, doit donc être verrouillé manuel (la connexion sur 0V).

• Que signifie le clignotement de dysfonctionnement (8 Hz) après l'apprentissage?

- Réserve de signal insuffisant; l'objet de référence programmé réfléchit trop peu de lumière
- Le détecteur a été programmé à l'extérieur de sa plage de réglage

• L'alimentation utilisée, couvre la classe 2 selon la norme UL 1310?

Ou appareil protégé en externe par un circuit R/C ou fusible UL à 30VAC/3A ou 24VDC/4A maximum.

Trademarks

qTarget®

Aline® inside



IO-Link Processdata

7	6	5	4	3	2	1	0
					Q		BDC1

Q:	Das Quality bit signalisiert, dass die Signalqualität unter einen festgelegten Wert gesunken ist.	The quality bit signals that the signal quality has fallen below the configured threshold.	Le bit de qualité qui indique la qualité du signal en vertu Une valeur fixe a baissé.
BDC1:	Status des logischen Schaltausgangs des Sensors.	Status of the logical switching output of the sensor.	Etat de la sortie de commutation logique du capteur

IO-Link General

- Sensor ist nach «Smart Sensor Profile» implementiert.
- Der Sensor unterstützt «Data Storage»
- Weitere Informationen zu IO-Link:
- Sensor is implemented according «Smart Sensor Profile»
- The sensor supports «Data Storage»
- More information about IO-Link:
- Le capteur est de «Smart Sensor Profile» mis en œuvre
- Le capteur prend en charge «Data Storage»
- Information complémentaire de IO-Link:

www.io-link.com

IO-Link Binary Data Channels

Index	Subindex (dec)	Access	Parameter name	Coding	Definition
0x003c (60)	01	R/W	Setpoint SP1	Uint16	Teach Point [mm] (TP) ¹⁾
	02	R/W	Setpoint SP2	Uint16	Not supported
0x003d (61)	01	R/W	Switchpoint logic	Uint8	0x00: not inverted 0x01: inverted
	02	R/(W)	Switchpoint mode	Uint8	Fixed value ²⁾ 0x01: Single point mode

¹⁾ um mit dem «Smart Sensor Profile» kompatibel zu sein, wird TP in den Parametern gespeichert statt SP1 und SP2

²⁾ Änderung des Standardwerts generiert eine PAR_VALOUTOFRNG Fehlermeldung

¹⁾ to be compliant with the «Smart Sensor Profile», the TP is stored in the parameters instead of SP1 and SP2

²⁾ writing another value than the default to this index generates a PAR_VALOUTOFRNG error code

¹⁾ pour être compatible avec «Smart Sensor Profile», le TP est mémorisé dans les paramètres au lieu de SP1 et SP2

²⁾ écrire une autre valeur que la défaut de ce générique taux d'index une PAR_VALOUTOFRNG code d'erreur

IO-Link system commands

Command	Value
Teach Apply	0x40
SP1 Single Value Teach	0x41
Teach Cancel	0x4F
Restore Factory settings	0x82

• System commands werden an den Index 0x002 (2) geschrieben

• System commands have to be written at Index 0x002 (2)

• Commandes du système doivent être écrites à l'index 0x002 (2)

IO-Link Teach-In Channels

Index	Subindex (dec)	Access	Parameter name	Coding	Definition
0x003a (58)	0	R/W	Teach Channel	-	See «Smart Sensor Profile»
0x003b (59)	0	R	Teach-In Status	-	See «Smart Sensor Profile» (Teach Flags and Teach State)

IO-Link Quality and Quality Bit Threshold

Index	Subindex (dec)	Access	Parameter name	Coding	Definition
0x0040 (64)	01	R	Quality value	Uint16	<100: Not enough signal strength
					100: Just exactly the signal strength that is required
					200: Twice of the signal strength that is required
0x0041 (65)	01	R/W	Quality bit threshold	Uint16	If the quality value falls below this threshold, the quality bit in the process data will be set. 0xFFFF: The quality bit will never be set.

IO-Link pre defined parameters

Index	Subindex (dec)	Access	Parameter name	Coding	Definition
0x0010 (16)	0	R	Vendor Name	String	Baumer Electric AG
0x0011 (17)	0	R	Vendor Text	String	www.baumer.com
0x0012 (18)	0	R	Device Name	String	<Product Key External> (<Product Key Internal>)
0x0013 (19)	0	R	Product Id	String	Baumer Article Number
0x0014 (20)	0	R	Device Text	String	Sensor specific
0x0015 (21)	0	R	Serial Number	String	<Production Order Nr>_<Serial Nr>
0x0018 (24)	0	R/W	Application Specific Tag	String	Default: Filled with *****, as recommended by the IO-Link spec.

IO-Link Baumer specific parameters

Index	Subindex (dec)	Access	Parameter name	Coding	Definition
0x0050 (80)	0	R/W	Local teach lock time	Unit8	0: Local teach never locked
					1 – 120: Local teach locked after n minutes 0xFF: Local teach always locked Default value: 5
0x0060 (96)	01	R/W	Response Delay Filter	Uint16	0: filter OFF (default) 5 ... 1000 ³⁾ : Delay in ms in steps of 5ms
	02	R/W	Release Delay Filter	Uint16	0: filter OFF (default) 5 ... 1000 ³⁾ : Delay in ms in steps of 5ms
0x0061 (97)	0	R/W	Minimum pulse duration	Uint16	0: pulse duration OFF (default) 5 ... 1000 ³⁾ : Minimum pulse in ms in steps of 5ms

³⁾ Der Wert wird auf 5ms gerundet

³⁾ The value is rounded to 5ms

³⁾ La valeur est arrondie à 5 ms