



Operating Manual

OX200 (Firmware 1.6.0 and higher)
Smart Profile sensors

EN-US

List of contents

1	About this document	5
1.1	Purpose.....	5
1.2	Warnings in this manual.....	5
1.3	Labels in this manual	6
1.4	Liability limitation	6
1.5	Scope of delivery.....	6
1.6	Name plate.....	7
2	Safety.....	8
2.1	Intended use	8
2.2	Personnel requirements	8
2.3	General safety instructions.....	9
3	Structure and working principle	10
3.1	Structure.....	10
3.2	Functionality	10
3.3	Reference surfaces.....	14
3.4	Measurement field of the sensor.....	14
4	Operating and display elements	16
4.1	Web interface	16
4.2	Sensor LEDs	17
5	Interfaces and protocols.....	18
5.1	Profinet.....	19
5.2	EtherNet/IP.....	23
5.3	Modbus TCP	29
5.4	OPC UA	33
5.5	IO-Link.....	37
5.6	UDP.....	39
5.7	SDK.....	44
5.8	Web interface	47
6	Operating functions	48
6.1	External triggering	48
6.2	Changing the parameter setup with Profinet and Ethernet/IP.....	50
7	Transport and storage	52
7.1	Transport.....	52
7.2	Delivery inspection	52
7.3	Storage.....	52

8 Installation	53
8.1 General information for mounting.....	53
8.2 Mounting the sensor.....	53
9 Electrical installation	55
9.1 Pin assignment.....	55
9.2 Connecting the sensor to electricity	57
10 Commissioning	58
10.1 Connecting the sensor to the PC	58
10.1.1 Allocating an IP address to the PC	58
10.1.2 Tracking the sensor's IP address.....	60
10.2 Profinet: Integrate sensor in PLC [OXM / OXS]	61
10.2.1 Wiring the sensor [OXM / OXS]	61
10.2.2 Connect sensor to PLC [OXM / OXS].....	61
10.2.3 Integrate sensor into the PLC project [OXM / OXS]	63
10.2.4 Acyclic parameter change.....	64
10.3 EtherNet/IP: Integrate sensor in PLC [OXM / OXS]	64
10.3.1 Wiring the sensor [OXM / OXS]	64
10.3.2 Connect sensor to PLC [OXM / OXS].....	64
10.3.3 Integrate sensor into the PLC project [OXM / OXS]	68
10.3.4 Reading/changing parameter setup via Parameter 151	70
10.3.5 Additional information about accessing cyclic process data	73
10.3.6 Additional notes about EtherNet/IP objects	74
10.4 Modbus TCP: Integrate sensor in PLC [OXM / OXS].....	74
10.5 OPC UA: Add sensor in client UaExpert [OXM / OXS]	74
10.6 Set up IO-Link [OXM / OXS]	76
11 Web interface	77
11.1 Description of the user interface	77
11.1.1 Header	77
11.1.2 Menu bar.....	78
11.1.3 Window Measurement Results	79
11.1.4 Footer.....	79
11.1.5 Visualisation area.....	79
11.1.6 Parametrisation area.....	79
11.2 Mode Monitoring	80
11.2.1 Saving measured data as a CSV file	81
11.3 Mode Global Parametrization.....	81
11.3.1 Changing the view	82
11.3.2 Adjusting the internal resolution.....	86
11.3.3 Optimising the exposure time	87
11.3.4 Adjusting the laser power	87
11.3.5 Calculating the surface profile	88
11.3.6 Set Trigger Mode	89
11.3.7 Aligning the sensor (height and distance mode).....	90
11.3.8 Mounting Assistant.....	90
11.3.9 Flex Mount: Compensating mounting angles	91

11.3.10	Flex Mount: Moving the reference surface	93
11.3.11	Resetting Flex Mount	94
11.3.12	Setting the limits of the field of view	94
11.4	Mode Measurement Tools Parametrization	95
11.4.1	Setting the position tracking (ROI tracking)	96
11.4.2	Setting the background tracking	96
11.4.3	Temporal Filter setting	97
11.4.4	Processing an invalid measured value	98
11.5	Outputs Parametrization mode	99
11.5.1	Setting the hysteresis	100
11.6	Mode Save Parameter-Setups	102
11.7	Mode Device Configuration	103
12	Maintenance	105
12.1	Cleaning the sensor	105
13	Troubleshooting	106
13.1	Resetting the sensor to the factory settings	106
13.2	Return and repair	106
13.3	Disposal	106
13.4	Accessories	106
14	Technical data	107
14.1	Dimensional drawing	107

1 About this document

1.1 Purpose

This operating manual (subsequently referred to as *manual*) allows the safe and efficient handling of the *SensControl* from Baumer.

The manual is a constituent part of the product. It must be kept in the immediate vicinity of the product and must be accessible to personnel at all times.

Personnel must have carefully read and understood this manual before beginning any work. The basic prerequisite for safe working is compliance with all safety instructions and handling instructions given in this manual.

In addition, the local occupational health and safety regulations and general safety regulations apply.

The illustrations in this manual are examples only. Deviations are at the discretion of Baumer at all times.

The product is not intended for permanent installation in automation systems.



NOTICE

The device can cause radio frequency interferences

This is a device of class A. This device can cause radio frequency interferences in residential areas. In such cases, the operator may be asked to carry out appropriate measures.

1.2 Warnings in this manual

Warnings draw attention to potential personal injury or material damage. The warnings in this manual indicate different hazard levels:

Symbol	Warning term	Explanation
	DANGER	Indicates an imminent potential danger with high risk of death or serious personal injury if not being avoided.
	WARNING	Indicates potential danger with medium risk of death or (serious) personal injury if not being avoided.
	CAUTION	Indicates a danger with low risk, which could lead to light or medium injury if not avoided.
	NOTE	Indicates a warning of material damage.
	INFO	Indicates practical information and tips that enable optimal use of the devices.

1.3 Labels in this manual

Identifier	Usage	Example
<i>Dialog element</i>	Indicates dialog elements.	Click the OK button.
<i>Unique name</i>	Indicates the names of products, files, etc.	<i>Internet Explorer</i> is not supported in any version.
Code	Indicates entries.	Enter the following IP address: 192.168.0.250

1.4 Liability limitation

All information and notes in this manual have been compiled in accordance with the applicable standards and regulations, the state of the art, and our many years of knowledge and experience.

The manufacturer accepts no liability for damage due to the following reasons:

- Non-observance of the manual
- Improper use
- Use of unqualified personnel
- Unauthorized conversions

The obligations agreed in the delivery contract, the general terms and conditions and the delivery conditions of the manufacturer and its suppliers, as well as the legal regulations valid at the time of conclusion of the contract apply.

1.5 Scope of delivery

The scope of delivery includes:

- 1 x sensor
- 1 x quickstart
- 1 x General information leaflet

In addition, you can find the following information, among other things, in digital format at www.baumer.com:

- Instruction manual
- Data sheet
- 3D CAD drawing
- Quickstart
- Dimensional drawing
- Connection diagram & pin assignment
- GSD file for Profinet connection and IO-Link file
- SDK as a ZIP archive
- Certificates (EU Declaration of Conformity, Profinet certificate, etc.)

1.6

Name plate

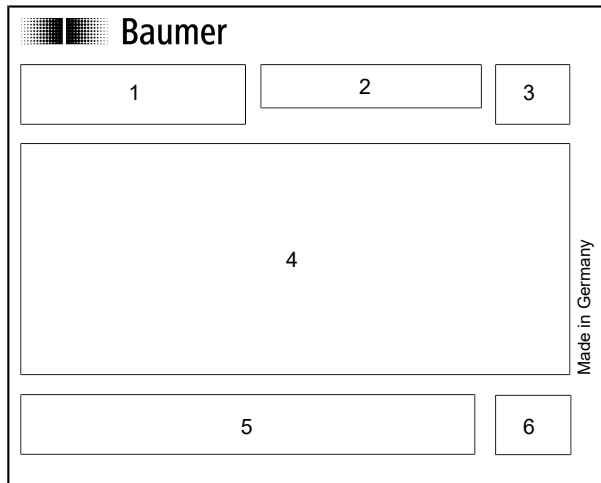

///. 1: Name plate on the sensor

1	Type code, MAC address, serial number	2	Item number, production date
3	Pin pictogram	4	Pin assignment
5	Labels	6	QR code (Baumer website)

2 Safety

2.1 Intended use

The sensor is used to measure surface profiles for the following purposes:

- Check and inspect:
 - Checking and inspection of object geometries, such as height measurement, inspection of surfaces, etc.
 - Inline quality control of object geometries.
- Measurements:
 - Axial diameter measurements.
 - Edge, crack, gap and flush measurements.
- Control and regulate:
 - Position control of feed parts.
 - Vision-guided robotics (control of robot grabber arms).
 - Position control of parts.

Any other use is considered improper.

For specifications of required qualifications see [Personnel requirements ▸ 8\]](#).

CAUTION

The product is intended exclusively for use according to this manual. Mandatory to observe the following instructions. Using other operating and adjustment equipment or following other procedures may result in exposure to hazardous radiation.

A detailed description of the radiation pattern emitted by a particular sensor can be found in the data sheet of the corresponding sensor.

2.2 Personnel requirements

Certain work with the product may only be carried out by specialized personnel.

Specialized personnel are staff members who can evaluate the tasks assigned to them and recognize potential danger, based on their training and work as well as a reliable understanding of technical safety issues.

Qualified personnel are divided into the following categories:

- **Instructed personnel:**

A person who has been informed and, if required, trained, by a specialist about the assigned tasks and potential dangers of improper behavior.
- **Specialist:**

A person who, based on his/her training, experience, and instruction, as well as his/her knowledge of applicable standards, rules, and accident prevention regulations, has been authorized to carry out the respectively required tasks, while recognizing and avoiding potential dangers.
- **Electrical specialist:**

A person with the appropriate specialist training, knowledge, and experience allowing him/her to recognize and avoid dangers originating from electricity.

2.3 General safety instructions

- Sensor installation and calibration only by skilled authorized personnel.
- Only use the fastenings and fastening accessories intended for the sensor for installation.
- Unused outputs must not be assigned. Unused wires of cable outputs must be insulated.
- Observe the minimum permitted cable bending radius.
- The system must be disconnected from the power supply before connecting the product electrically.
- Where mandatory, use shielded cables for protection against electromagnetic interference.
- Where plug-in connections are added to shielded cables by the customer, these plug-in connections must be EMC compliant and the cable shield must be attached to the connector housing over a large surface area.

CAUTION

The sensor has laser class 2.

Never direct the laser at an eye. It is recommended not to direct the beam into empty space but to stop it with a matt sheet or object.

CAUTION

Release of dangerous laser radiation when the sensor is defective.

Use of the sensor with a fractured front panel or loose/exposed laser optics can release dangerous laser radiation.

- a) In case of a fractured front panel or loose/exposed laser optics disconnect the laser from the power immediately.
- b) Have the sensor checked by an authorised person (specialist). Do not operate the sensor until that time.

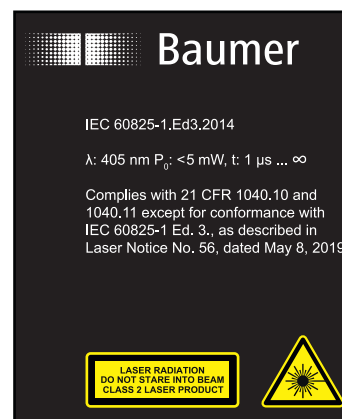

3 Structure and working principle

3.1 Structure

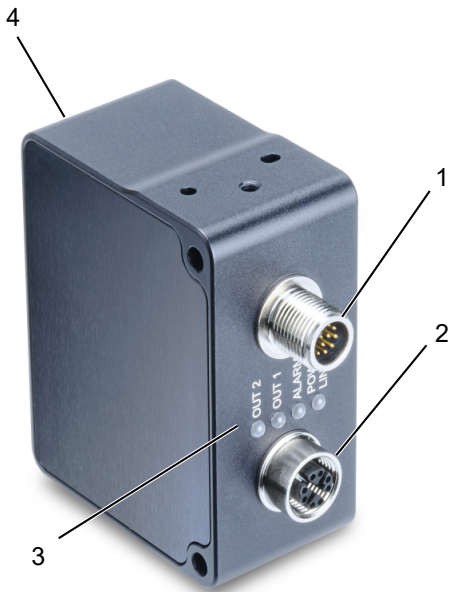

III. 2: OX200 – Structure

1	Electrical connection M12 12-pin, A-coded, male	2	Ethernet connection M12 8-pin, X-coded, female
3	Sensor LEDs	4	Front panel

3.2 Functionality

The sensor measures the surface profile of an object along the projected laser line. User can retrieve the measured surface profile either via the integrated web server, the UDP interface or the SDK (software development kit). The OXM sensor variant features additional functions (tools) allowing for geometric profile measurements (e.g. width, height, diameter or angle). These measured values are provided at the integrated process interface, the switching outputs or the analogue output.

Triangulation principle

The sensor operates on the laser triangulation principle:

1. Using a cylindrical lens, a laser beam expands to a laser line and is projected onto the surface of the measured object.
2. The measured object reflects the laser line.
3. The reflected laser line is projected onto a surface camera in the sensor.
4. The sensor uses the camera image and stored calibration data to calculate the profile of the object to be measured.

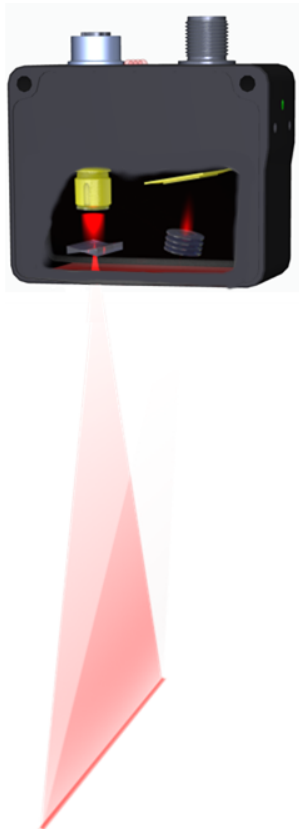

III. 3: OX200 – Triangulation principle

Working principle of the OXM and OXS variant

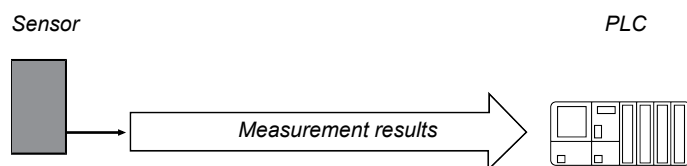

III. 4: OXM200 - working principle

- The sensor features smart measurement functions (tools) as well as integrated image processing and delivers precise results in physical units such as mm or degrees.
- There are varied measurement functions, such as height, edge, width, gap, angle and distance.
- The measured values such as the difference between 2 heights is put into correlation.
- Position tracking of evaluation windows.

Working principle of the OXP variant

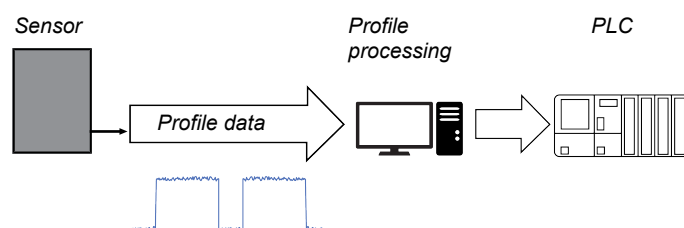

III. 5: OXP200 – working principle

Overview of the available measuring functions depending on the version

Measuring functions	OXS-Edge ¹	OXM ²	OXF ³
Height / Distance		X	
Edge	X	X	
Width	X	X	
Circle		X	
Straight / Angle		X	
Surface		X	
Profile Matcher		X	
Segment Selector	X	X	
Slider X / Z / Distance	X	X	
Angle Gauge		X	
Profile data		X	X

Measurement frequency, measurement repeat time and response time

The full sensor measurement cycle comprises the following steps:

1. Exposure and read out
2. Calculation
3. Measured value output

Process steps are executed in parallel for increased measurement speed. Below are two scenarios: Measurement rate limited by exposure time (fig.1) and) and measurement rate limited by processing time (fig.2)

¹ OXS = Specialized profile sensor

² OXM = Multi tool profile sensor

³ OXF = Only profile evaluation

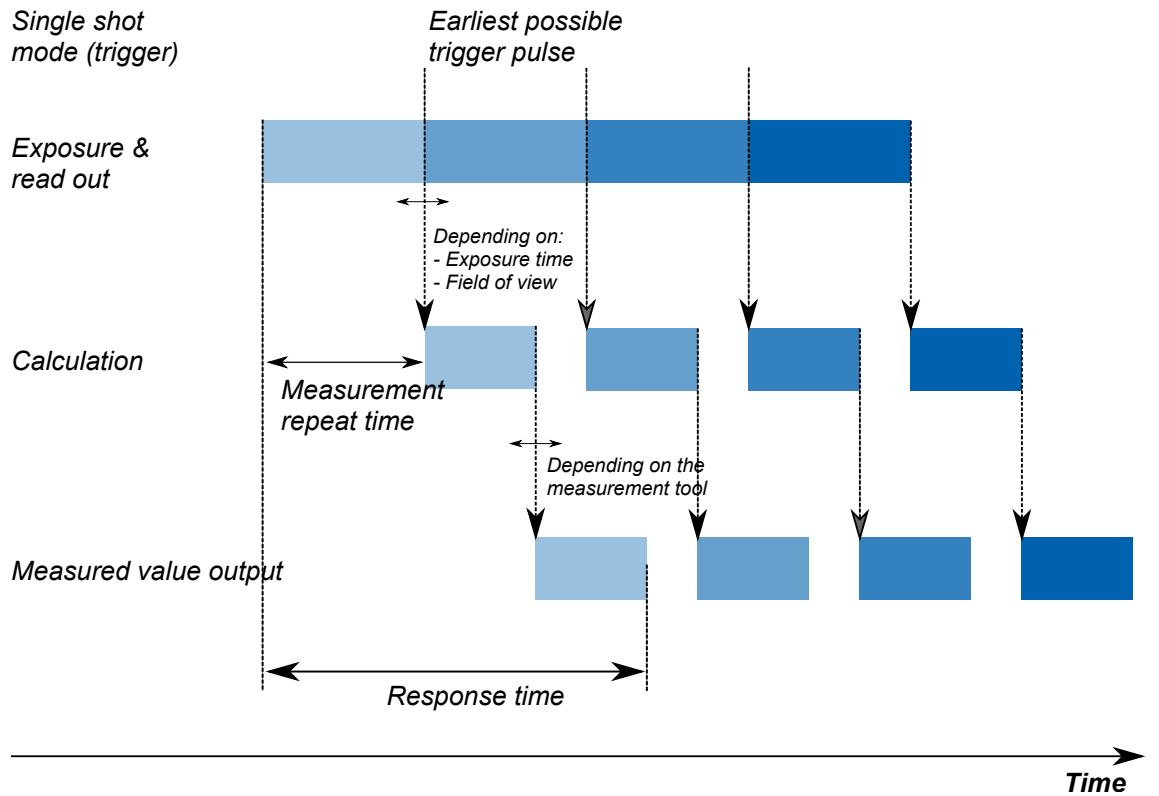

III. 6: OX200 – Measurement rate limited by exposure time

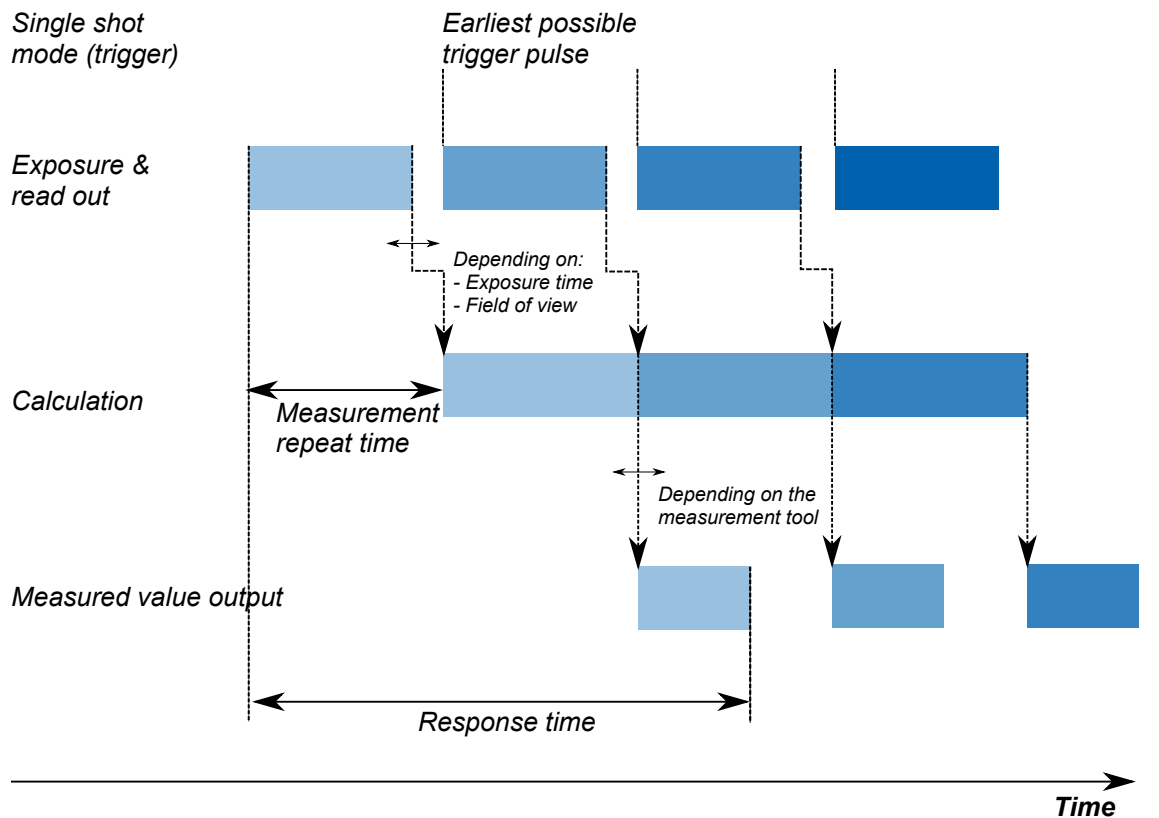

III. 7: OX200 – Measurement rate limited by the processing time

The time between two exposures is called measurement repetition time and can be converted into measurement frequency. The calculated measurement frequency indicates how many measured values the sensor can output per second.

- **Formula for calculating the measurement frequency:**
 - Measurement frequency [kHz] = 1 / Measurement repeat time [ms]

3.3 Reference surfaces

The reference levels R1 to R3 below enable simplified sensor alignment during mounting and commissioning.

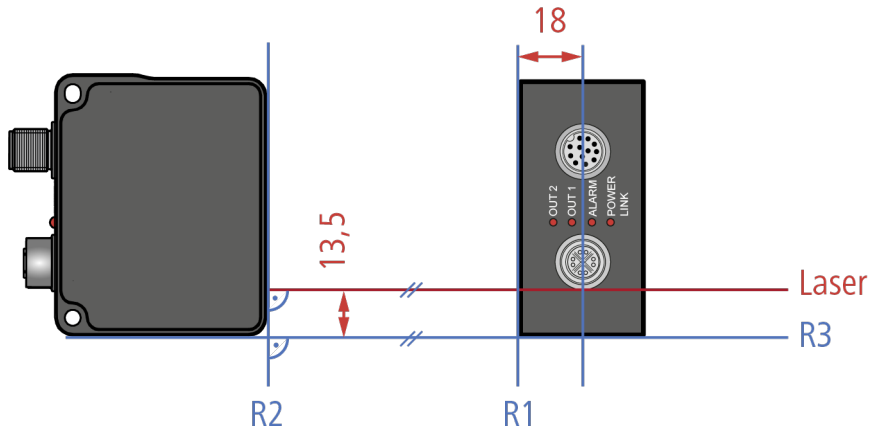

III. 8: OX200 – Reference surfaces

R1	Reference level 1; positioned parallel to the lateral surface at a right angle towards the laser beam	R2	Reference surface 2; positioned parallel to the front surface at a right angle to the laser beam
R3	Reference surface 3; extends parallel to the laser beam		

3.4 Measurement field of the sensor

The following illustration shows the measurement field of the sensor. The sensor can be operated in both height mode (object space) and distance mode (sensor space) (see also [Aligning the sensor \(height and distance mode\)](#) [▶ 90]). The sensor will not detect any objects to be measured within the blind region (CD). Presence of any objects to be measured in the blind region may lead to incorrect measured values.

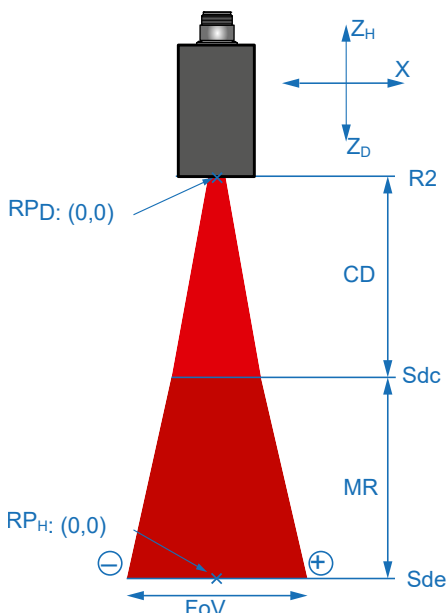

III. 9: OX200 – Measurement field

Z _H	Positive alignment of the Z axis in the height mode	Z _D	Positive alignment of the Z axis in the distance mode
X	X axis	RP _D	Zero point in the distance mode
RP _H	Zero point in the height mode	R2	Reference surface 2
CD	Blind region	MR	Measuring range
Sdc	Start of the measuring range	Sde	End of the measuring range
FoV	Field of view width	-	Left; area with negative X values
+	Right; area with positive X values		

Transmission and receiving axis

The transmission and receiving axes can lie in the areas shown in blue in the figures below. The exact axes depend on the position of the object. Objects that should not be measured should be kept away from this area as they can interfere with the measurement and lead to incorrect measured values.

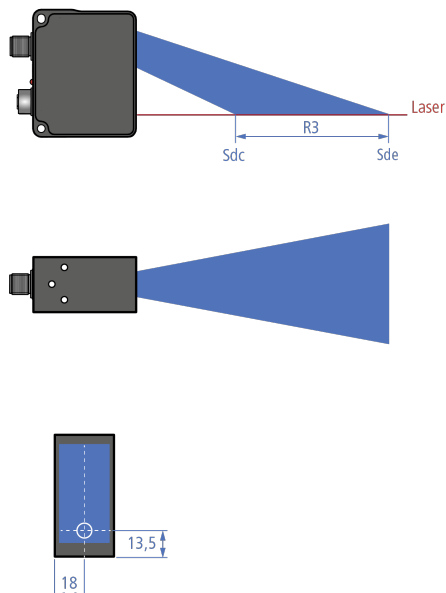

III. 10: OX200 – Transmission and receiving axes

4 Operating and display elements

4.1 Web interface

The sensor features a web interface enabling sensor parameterization and data visualization. To this end, the sensor integrates web server. Web interface access is via web browser.

For a detailed description of the web interface, the individual elements of the user interface and all required operating processes, see [Web interface](#) [77].



III. 11: Web interface – Overview

Also see about this

[Web interface](#) [47]

4.2 Sensor LEDs



III. 12: OX200 – LEDs on the sensor

Denotation	Colour	Illuminated	Flashing
OUT 2	Yellow	Switching output 2 active.	Signal reserve of the detected object is close to the detection limit.
OUT 1	Yellow	Switching output 1 active.	Signal reserve of the detected object is close to the detection limit.
ALARM	Red	<ul style="list-style-type: none"> ■ Sensor starts up. ■ Measured value is invalid. ■ Sensor is parametrised via the web interface. 	Signal reserve of the detected object is close to the detection limit.
POWER LINK	Green	<ul style="list-style-type: none"> ■ The sensor is ready for operation, but there is no active Ethernet connection. ■ As soon as the Ethernet connection is active, the LED is turned off. 	Short circuit at switching output 1 or 2.
	Blue	<ul style="list-style-type: none"> ■ Ethernet link active. 	Data packets are received or transferred via Ethernet.
Special modes:			
OUT 1, OUT 2, POWER LINK	Yellow		DCP signalling (Profinet device identification) blinks with 1 Hz.
OUT 1, OUT 2, ALARM, POWER LINK	Yellow, red, violet		All LEDs flash twice, then a longer pause. Indicates a sensor error.

5 Interfaces and protocols

The sensor offers a variety of interfaces and protocols (multi-protocol sensor). The available functions and measuring rates depend on the protocol used.

The sensor supports one client connection per protocol. At any time there is read access via the protocols. Write access is only permissible in the parametrisation mode. Only one interface at a time can be in parametrisation mode.

OXP version sensor

You can configure and parametrise sensors of the OXP version via the integrated web interface as well as via a freely available software development kit (see also [SDK \[▶ 44\]](#)). With the OXP version, it is not possible to communicate via process interfaces such as Profinet, Modbus/TCP, OPC UA, and IO-Link, since the sensor does not supply any measured values. The profile data is transmitted via UDP (User Datagram Protocol).

Sensor variants OXM / OXS

In the OXM version, you configure and parameterize the sensor via the integrated web interface. The SDK (Software Development Kit) provided for the OXM version offers you a limited range of functions [SDK \[▶ 44\]](#), meaning that you cannot edit tool sequences or fully parameterize tools. Read access to the measured values and switching of parameter sets can also take place via the process interfaces Profinet, EtherNet/IP, Modbus TCP, OPC UA and IO-Link.

Industrial Ethernet

Industrial Ethernet protocols (e.g. Profinet) enable the communication between the sensor and a PLC. Basically, transmission allows for the following data:

- General control and status data (measuring rate, time stamp, status of outputs, etc.)
- Result data (parametrisation of the result data via the web interface)
- Parameter setups (preset parameterization, parameter definition)
- Laser on/off
- Trigger measuring operation

NOTICE

The following functions are not available for all protocols/interfaces:

Laser on/off

Trigger measuring operation

The protocol is defined by the respective Industrial Ethernet specification. You can select the protocol on the sensor and make the relevant settings via the web interface (see [Mode Device Configuration \[▶ 103\]](#)).

Cyclic/acyclic data

During data transfer, a distinction is made between cyclic data and acyclic data:

- **Cyclic data** is exchanged periodically as connected measured values between the devices and the control (PLC). The desired time period is specified during configuration of the control. The consistency of the data within a block can be verified via the associated status data. For example, for valid measured values it must be ensured that the sensor is not in the parametrisation mode (parametrisation mode flag is not active).
- **Acyclic data** is only transferred between the devices and the control when required and in case of special events. An example of acyclic data transfer is the exchange of parametrisation and configuration data or diagnostic messages between the devices and the control during ongoing operation or when establishing the connection.

For the precise range of interfaces and protocols, please see the data sheet that is available for download at www.baumer.com/OX200.

5.1 Profinet

Profinet (Process Field Network) is an open Industrial Ethernet standard from PI (Profibus and Profinet International) and is based on existing IT standards (such as UDP, for example).

For information on Profinet commissioning, see [Profinet: Integrate sensor in PLC \[OXM / OXS\] \[▶ 61\]](#).

PROFINET data organization is modular. Data is clustered in logical groups and mapped to the existing interfaces. For data mapping and evaluation in the PLC utilize the relevant manufacturer-specific tool.

Mapping the sensor functionalities to PROFINET modules

The following tables give an overview of the arrangement of the sensor functions (data elements) in the individual Profinet modules. The data elements are organised from sub-modules for easier evaluation.

Module: Control and status

- Module ID: 3
- Inserted by default in slot 1

Input data sensor > PLC:

Sub-module ID	Data element	Data type	Description
1	Parametrisation mode	UInt8	<ul style="list-style-type: none"> ▪ Status of the operating mode. ▪ True, when the sensor is in the parametrisation mode.
2	Time synchronization	UInt8	<ul style="list-style-type: none"> ▪ Status of the time synchronization. ▪ True, if time has been synchronised.
3	Valid values	UInt8	<ul style="list-style-type: none"> ▪ Status of the validity of the values. ▪ True, when at least one measurement has been made. ▪ Serves the verification of NaN (Not a Number) measured values.
4	Alarm state	UInt8	<ul style="list-style-type: none"> ▪ Status of the alarm. ▪ True, when the alarm is active.
5	Quality status	UInt8	<ul style="list-style-type: none"> ▪ Information about the quality of the measurements: <ul style="list-style-type: none"> ▪ 0: good signal (valid) ▪ 1: weak signal (unsafe) ▪ 2: no signal (invalid)
6	Measurement rate (Hz)	Float32	<ul style="list-style-type: none"> ▪ Measurement rate at which the measured values were recorded (in Hz).
7	Time stamp (s)	UInt32	<ul style="list-style-type: none"> ▪ Value of the time stamp of the current measured values (in s).
8	Time stamp (µs)	UInt32	<ul style="list-style-type: none"> ▪ Value of the time stamp of the current measured values (in µs).
9	Encoder value	UInt16	<ul style="list-style-type: none"> ▪ Value of the encoder (if connected).
10	Output 1	UInt8	<ul style="list-style-type: none"> ▪ Information on the status of the available digital outputs. ▪ True, when the concerned output is activated.
11	Output 2	UInt8	

Acyclic changing the parameter setup

(Possibility of a setup definition when establishing a connection)

Sensor input data > PLC

PLC > sensor input data

Sub-module ID	Data element	Index	Data type	Default value	Visible	Description
1	Parameter setup	1	UInt8	1	Yes	<ul style="list-style-type: none"> Currently used parameter setup 1 to 32. Change only possible in the parametrisation mode.

Module: Result data

- Module ID: 4
- Inserted by default in slot 2

Input data sensor > PLC:

Sub-module ID	Data element	Data type	Description
1	Measured value 1	Float32	<ul style="list-style-type: none"> Result data of the set measurement tools parametrised via the web interface.
2	Measured value 2	Float32	
3	Measured value 3	Float32	
4	Measured value 4	Float32	
5	Measured value 5	Float32	
6	Measured value 6	Float32	
7	Measured value 7	Float32	

With the result data module the measured values are transferred. The configuration of the result telegram takes place during the parametrisation of the measurement tools in the integrated web interface. The order of the measured values in the result data corresponds to the order of the measured values parametrised in the web interface. You can change the order in the web interface (see [Mode Measurement Tools Parametrization](#) [▶ 95]).

Transfer of the result data always involves the transfer of 7 measured values. Unused measured values, which are not displayed in the web interface either, contain an invalid value (NaN) each and should therefore accordingly not be evaluated by the measurement application.

Module: Sensor Control

- Module ID: 5
- Plug-in slot 3

Input data sensor > PLC (Input):

Sub-module ID	Data element	Data type	Description
1	Sensor Control IN	UInt8	Information on: <ul style="list-style-type: none"> Bit 0: <ul style="list-style-type: none"> 1 = Laser ON 0 = Laser OFF Bit 1: Trigger measuring operation

PLC parameterization data > Sensor (Output):

Sub-module ID	Data element	Data type	Description
1	Sensor Control OUT	UInt8	Control of: <ul style="list-style-type: none"> ▪ Bit 0: <ul style="list-style-type: none"> ▪ 1 = Laser ON ▪ 0 = Laser OFF ▪ Bit 1: Trigger measuring operation

Module Sensor Control is for line laser and measurement trigger control:

The application of bit 1 varies according to trigger mode. For explanations on this function see chapter: [External triggering \[▶ 48\]](#)

NOTICE

If this module is applied, set bit 0 to 1 (Laser On) to enable sensor measurement.

Measurement trigger can be via digital input *IN 1 (sync in)* and bit 1 of *Sensor Control*. To set the trigger mode in the web interface, proceed as follows: [Set Trigger Mode \[▶ 89\]](#)

Module: Parameter

- Module ID: 6
- Plug-in slot 4

Input data sensor > PLC (Input):

Sub-module ID	Data element	Data type	Description
1	Parameter Status IN	UInt8	Information or control of the following: <ul style="list-style-type: none"> ▪ Bit 0: Done ▪ Bit 1: Busy ▪ Bit 2: Error ▪ Bit 3...255: reserved
	Parameter value IN	4 Bytes, data type depending on Function ID, see table Function ID	Result depends on Parameter Status IN: <ul style="list-style-type: none"> ▪ Done = 1 (requested value) ▪ Error = 1 (error code)

PLC parameterization data > Sensor (Output):

Sub-module ID	Data element	Data type	Description
1	Parameter Ctrl OUT	UInt8	Control of parameter change (see timing diagram): <ul style="list-style-type: none"> ▪ Bit 0: Request ▪ Bit 1: <ul style="list-style-type: none"> ▪ 1 = Write ▪ 0 = Read ▪ Bit 2...255: Reserved
	Parameter-ID OUT	UInt16 2 bytes	see table Function ID
	Parameter value OUT	4 Bytes, data type depending on Function ID, see table Function ID	New parameter value

With the *Parameter* module, you have the option of changing parameters on the sensor. The ParameterID (see function list) defines the parameter function that is to be changed.

The function list currently contains the *Change parameter setup* function.

Function list (Function ID)

Parameter ID	Parameter Function	Data type	Parameter Value
0	Changing the parameter setup	UInt8	1 ... 32 <ul style="list-style-type: none"> ▪ 1: Parameter setup 1 ▪ 2: Parameter setup 2 ▪ ... ▪ 32: Parameter setup 32

The function is explained in the following chapter: [Changing the parameter setup with Profinet and Ethernet/IP \[► 50\]](#).

5.2 EtherNet/IP

EtherNet/IP is a TCP/IP- and UDP/IP-based network protocol that is widely used in automation technology. As with other protocols developed further by ODVA, it uses the Common Industrial Protocol (CIP) in the application layer.

Connectivity

The sensor supports the following connections:

(1)

Input only REAL:

Input-Only Connection with Assembly Instance 100 (IN) and Instance 238 (Heartbeat, OUT):

Path: 20 04 24 97 2C EE 2C 64

Originator -> Target size: 0 (pure data)

Target -> Originator size: 50 (pure data)

(2)

In-Out REAL with Parameter

Exclusive-Owner Connection with Assembly Instance 101 (IN) and Instance 110 (OUT):

Path: 20 04 24 00 2C 6E 2C 65

O -> T size: 8 (32-bit header)

T -> O size: 56 (pure data)

(3)

Input Only INT

Input-Only Connection with Assembly Instance 102 (IN) and Instance 238 (Heartbeat, OUT):

Path: 20 04 24 97 2C EE 2C 66

O -> T size: 0 (pure data)

T -> O size: 34 (pure data)

(4)

In-Out INT with Parameter

Exclusive-Owner Connection with Assembly Instance 103 (IN) and Instance 110 (OUT):

Path: 20 04 24 00 2C 6E 2C 67

O -> T size: 8 (32-bit header)

T -> O size: 40 (pure data)

Mapping the sensor functions on the CIP assembly objects

The following tables give an overview of the arrangement of the sensor functions (data elements) in the individual assembly objects. The assembly objects can be accessed via either an implicit or an explicit connection.

(1)

Sensor input data > PLC:

Assembly Object (Class Code: 0x04), Instance 100

Byte	Data element	Data type
0	Parametrisation mode	UInt8
1	Time synchronization	UInt8
2	Valid values	UInt8
3	Alarm state	UInt8
4	Quality status	UInt8

Byte	Data element	Data type
5	Output 1	UInt8
6	Output 2	UInt8
7	Reserved	UInt8
8 ... 11	Measured value 1	Float32
12 ... 15	Measured value 2	Float32
16 ... 19	Measured value 3	Float32
20 ... 23	Measured value 4	Float32
24 ... 27	Measured value 5	Float32
28 ... 31	Measured value 6	Float32
32 ... 35	Measured value 7	Float32
36 ... 39	Measurement rate (Hz)	Float32
40 ... 43	Time stamp (s)	UInt32
44 ... 47	Time stamp (μ s)	UInt32
48 ... 49	Encoder value	UInt16

(2)

Sensor input data > PLC:

Assembly Object (Class Code: 0x04), Instance 101

Byte	Data element	Data type
0	Parametrisation mode	UInt8
1	Time synchronization	UInt8
2	Valid values	UInt8
3	Alarm state	UInt8
4	Quality status	UInt8
5	Output 1	UInt8
6	Output 2	UInt8
7	Reserved	UInt8
8 ... 11	Measured value 1	Float32
12 ... 15	Measured value 2	Float32
16 ... 19	Measured value 3	Float32
20 ... 23	Measured value 4	Float32
24 ... 27	Measured value 5	Float32
28 ... 31	Measured value 6	Float32
32 ... 35	Measured value 7	Float32
36 ... 39	Measurement rate (Hz)	Float32
40 ... 43	Time stamp (s)	UInt32
44 ... 47	Time stamp (μ s)	UInt32
48 ... 49	Encoder value	UInt16

Byte	Data element	Data type
50	Sensor Control IN: <ul style="list-style-type: none"> ▪ Bit 0: <ul style="list-style-type: none"> ▪ 1 = Laser ON ▪ 0 = Laser OFF ▪ Bit 1: Trigger measuring operation 	UInt8
51	Parameterization state IN: <ul style="list-style-type: none"> ▪ Bit 0: Done ▪ Bit 1: Busy ▪ Bit 2: Error 	UInt8
52 ... 55	Parameter value IN Result depending on parameterization state IN (see above): <ul style="list-style-type: none"> ▪ Done = 1 -> requested value ▪ Error = 1 -> Error code 	4 Bytes, data type depending on Function ID, see table Function ID

(3)

Sensor input data > PLC:

Assembly Object (Class Code: 0x04), Instance 102

Byte	Data element	Data type
0	Parametrisation mode	UInt8
1	Time synchronization	UInt8
2	Valid values	UInt8
3	Alarm state	UInt8
4	Quality status	UInt8
5	Output 1	UInt8
6	Output 2	UInt8
7	Reserved	UInt8
8 ... 9	Measured value 1 ^I	Int16
10 ... 11	Measured value 2 ^I	Int16
12 ... 13	Measured value 3 ^I	Int16
14 ... 15	Measured value 4 ^I	Int16
16 ... 17	Measured value 5 ^I	Int16
18 ... 19	Measured value 6 ^I	Int16
20 ... 21	Measured value 7 ^I	Int16
22 ... 23	Measurement rate (Hz) ^{II}	Int16
24 ... 27	Time stamp (s)	UInt32
28 ... 31	Time stamp (µs)	UInt32
32 ... 33	Encoder value	UInt16

^I Divide the received measured value by 100 to obtain the result in the physical measuring unit.

^{II} Divide the received measuring rate by 10 to obtain the measuring rate in Hz.

(4)

Sensor input data > PLC:

Assembly Object (Class Code: 0x04), Instance 103

Byte	Data element	Data type
0	Parametrisation mode	UInt8
1	Time synchronization	UInt8
2	Valid values	UInt8
3	Alarm state	UInt8
4	Quality status	UInt8
5	Output 1	UInt8
6	Output 2	UInt8
7	Reserved	UInt8
8 ... 9	Measured value 1 ⁱ	Int16
10 ... 11	Measured value 2 ⁱ	Int16
12 ... 13	Measured value 3 ⁱ	Int16
14 ... 15	Measured value 4 ⁱ	Int16
16 ... 17	Measured value 5 ⁱ	Int16
18 ... 19	Measured value 6 ⁱ	Int16
20 ... 21	Measured value 7 ⁱ	Int16
22 ... 23	Measurement rate (Hz) ⁱⁱ	Int16
24 ... 27	Time stamp (s)	UInt32
28 ... 31	Time stamp (µs)	UInt32
32 ... 33	Encoder value	UInt16
34	Sensor Control IN: <ul style="list-style-type: none"> ▪ Bit 0: <ul style="list-style-type: none"> ▪ 1 = Laser ON ▪ 0 = Laser OFF ▪ Bit 1: Trigger measuring operation 	UInt8
35	Parameterization state IN: <ul style="list-style-type: none"> ▪ Bit 0: Done ▪ Bit 1: Busy ▪ Bit 2: Error 	UInt8
36 ... 39	Parameter value IN Result depending on parameterization state IN (see above): <ul style="list-style-type: none"> ▪ Done = 1 -> requested value ▪ Error = 1 -> Error code 	4 Bytes, data type depending on Function ID, see table Function ID

ⁱ Divide the received measured value by 100 to obtain the result in the physical measuring unit.

ⁱⁱ Divide the received measuring rate by 10 to obtain the measuring rate in Hz.

PLC parameterization data > Sensor:
 Assembly Object (Class Code: 0x04), Instance 110

Byte	Data element	Data type
0	Sensor Control OUT: <ul style="list-style-type: none"> ▪ Bit 0: <ul style="list-style-type: none"> ▪ 1 = Laser ON ▪ 0 = Laser OFF ▪ Bit 1: Trigger measuring operation ▪ 2 ...255: reserved 	UInt8
1	Parameter Ctrl OUT: <ul style="list-style-type: none"> ▪ Bit 0: Request ▪ Bit 1: <ul style="list-style-type: none"> ▪ 1 = Write ▪ 0 = Read ▪ 2 ...255: reserved 	UInt8
2 ... 3	Parameter ID OUT (see table Function ID)	UInt16
4 ... 7	Parameter value OUT new parameter value	4 Bytes, data type depending on Function ID, see table Function ID

NOTICE

If this module is applied, set bit 0 to 1 (Laser On) to enable sensor measurement.

Function ID

Parameter ID	Parameter Function	Data type	Parameter Value
0	Changing the parameter setup	UInt8	1 ... 32 <ul style="list-style-type: none"> ▪ 1: Parameter setup 1 ▪ 2: Parameter setup 2 ▪ ... ▪ 32: Parameter setup 32

For explanations on this function see chapter: [Changing the parameter setup with Profinet and Ethernet/IP \[▶ 50\]](#)

Acyclic messages

Parameterization data PLC > Sensor:

Assembly Object (Class Code: 0x04), Instance 151, Attribute 3

Byte	Data element	Data type
0	Parameter setup	UInt8

Input data sensor > PLC:

Assembly Object (Class Code: 0x04), Instance 152, Attribute 3

Byte	Data element	Data type
0	Sensor Control IN: <ul style="list-style-type: none"> ▪ Bit 0: <ul style="list-style-type: none"> ▪ 1 = Laser ON ▪ 0 = Laser OFF ▪ Bit 1: Trigger measuring operation ▪ 2 ...255: Reserved 	UInt8
1	Parameterization state IN: <ul style="list-style-type: none"> ▪ Bit 0: Done ▪ Bit 1: Busy ▪ Bit 2: Error 	UInt8
2 ... 5	Parameter value IN Result depending on parameterization state IN (see above): <ul style="list-style-type: none"> ▪ Done = 1 -> requested value ▪ Error = 1 -> Error Code 	4 bytes, data type depending on the applied parameter, see table Function ID

An integration example can be found in [EtherNet/IP: Integrate sensor in PLC \[OXM / OXS\]](#) [▶ 64].

5.3 Modbus TCP

Modbus TCP is a protocol with a long history that is already supported by many programmable logic controllers as delivered or can be retrofitted using a software module. For PC-based systems, libraries for different programming languages are available. The standard is freely available on the website of the Modbus organisation. Visit <http://www.modbus.org>

For information regarding the commissioning of Modbus TCP, see *Modbus TCP: Integrate sensor in PLC [OXM / OXS]* [▶ 74].

Mapping the sensor functionality on the Modbus data model

The functionality of the sensor can be accessed by reading or writing entries in the tables **Discrete Inputs**, **Input Registers**, and **holding registers**. The following Modbus function codes (FC) are supported:

- Read Discrete Inputs (FC 02)
- Read Input Registers (FC 04)
- Read Holding Registers (FC 03)
- Write Single Holding Register (FC 06)
- Write Multiple Holding Registers (FC 16)

The following FC tables are independent of each other, so the same address may represent different functions in each table. Basically, Modbus registers are limited to 16 bits. Therefore, when reading or writing larger values, several registers must be taken into account for the respective operation. Reading or writing only part of the specified address is not supported. Less significant words are saved under the inferior address. Example:

- Value (UInt32): 0x12345678
- Register Address n: 0x5678
- Register Address n+1: 0x1234



INFO

1 Modbus register corresponds to 2 bytes. If the data type of a sensor parameter is wider than a 2 byte Modbus register, the parameter is divided among several Modbus registers. The less significant bits are located at the smaller address and the more significant bits at the larger address (Little Endian).

In general, all registers enable write and read. Reading a register with write access only will reply 0xFFFF.

Holding Registers

NOTICE

You must request the **parameterization** mode, before you can load the parameter setup or change the laser status. Close the web interface first or switch to **Monitoring Mode**.

The following table provides an overview of the Index Commands **Holding Registers**. These can be reached with functions 03/06/16.

Address	Data element	Data type	Access	Description
0 (1 register)	Request parametrisation mode.	UInt16	Write	Request parametrisation mode by writing a random value.
1 (1 register)	Exit parametrisation mode.	UInt16	Write	Exit active parametrisation mode by writing a random value.
410 (1 register)	Laser ON/OFF	UInt16	reading/writing	Laser status 0 = OFF 1 = ON
501 (1 register)	Load parameter setup number.	UInt16	Write	Load a previously parametrised parameter setup.

Input Registers

The following tables provide an overview of Index Commands **Input Registers**. These can be reached with function 04.

This function code will read 1 to 125 related input registers in a remote device. The PDU query (**Process Data Unit**) specifies the start register address and the number of registers. PDU register addressing starts with zero. For this reason, input registers 1-16 are addressed as 0-15.

Address	Data element	Data type	Access	Offset	Description
0 ... 32 (33 registers)	Vendor Info	String[65]	Read	0	Manufacturer name
40 ... 88 (49 registers)	Device Info	String[9]	Read	0 ... 3	Product ID
				4 High byte	
		String[65]		4 Low byte	Sensor type
				5 ... 36	
		String[20]		37 ... 46	Serial number
String[2]	47 ... 48	Padding			

Address	Data element	Data type	Access	Offset	Description								
200 ... 223 (24 registers)	All Measurement Values		Read										
	Status	UInt16		0	Status <table border="1"> <tr> <td>Bit 0</td> <td>Parametrisation mode is active.</td> </tr> <tr> <td>Bit 1</td> <td>Time synchronised with NTP server.</td> </tr> <tr> <td>Bit 2</td> <td>Valid values (measured values allow for interpretation).</td> </tr> <tr> <td>Bit 3</td> <td>Alarm enabled.</td> </tr> </table>	Bit 0	Parametrisation mode is active.	Bit 1	Time synchronised with NTP server.	Bit 2	Valid values (measured values allow for interpretation).	Bit 3	Alarm enabled.
Bit 0	Parametrisation mode is active.												
Bit 1	Time synchronised with NTP server.												
Bit 2	Valid values (measured values allow for interpretation).												
Bit 3	Alarm enabled.												
	Quality	UInt8		1	Quality information on the current measured values. <table border="1"> <tr> <td>0</td> <td>OK</td> </tr> <tr> <td>1</td> <td>Weak signal.</td> </tr> <tr> <td>2</td> <td>No signal.</td> </tr> </table>	0	OK	1	Weak signal.	2	No signal.		
0	OK												
1	Weak signal.												
2	No signal.												
	Output	UInt8		2	Outputs <table border="1"> <tr> <td>Bit 0</td> <td>Status of binary output 1.</td> </tr> <tr> <td>Bit 1</td> <td>Status of the alarm outputStatus of binary output 2.</td> </tr> </table>	Bit 0	Status of binary output 1.	Bit 1	Status of the alarm outputStatus of binary output 2.				
Bit 0	Status of binary output 1.												
Bit 1	Status of the alarm outputStatus of binary output 2.												
	Measured value 1	Float32			Measured value parameterized in advance via web interface. <table border="1"> <tr> <td>3</td> <td>Low 2 bytes</td> </tr> <tr> <td>4</td> <td>High 2 bytes</td> </tr> </table>	3	Low 2 bytes	4	High 2 bytes				
3	Low 2 bytes												
4	High 2 bytes												
	Measured value 2	Float32			Measured value parameterized in advance via web interface. <table border="1"> <tr> <td>5</td> <td>Low 2 bytes</td> </tr> <tr> <td>6</td> <td>High 2 bytes</td> </tr> </table>	5	Low 2 bytes	6	High 2 bytes				
5	Low 2 bytes												
6	High 2 bytes												
	Measured value 3	Float32			Measured value parameterized in advance via web interface. <table border="1"> <tr> <td>7</td> <td>Low 2 bytes</td> </tr> <tr> <td>8</td> <td>High 2 bytes</td> </tr> </table>	7	Low 2 bytes	8	High 2 bytes				
7	Low 2 bytes												
8	High 2 bytes												
	Measured value 4	Float32			Measured value parameterized in advance via web interface. <table border="1"> <tr> <td>9</td> <td>Low 2 bytes</td> </tr> <tr> <td>10</td> <td>High 2 bytes</td> </tr> </table>	9	Low 2 bytes	10	High 2 bytes				
9	Low 2 bytes												
10	High 2 bytes												
	Measured value 5	Float32			Measured value parameterized in advance via web interface. <table border="1"> <tr> <td>11</td> <td>Low 2 bytes</td> </tr> <tr> <td>12</td> <td>High 2 bytes</td> </tr> </table>	11	Low 2 bytes	12	High 2 bytes				
11	Low 2 bytes												
12	High 2 bytes												
	Measured value 6	Float32			Measured value parameterized in advance via web interface. <table border="1"> <tr> <td>13</td> <td>Low 2 bytes</td> </tr> <tr> <td>14</td> <td>High 2 bytes</td> </tr> </table>	13	Low 2 bytes	14	High 2 bytes				
13	Low 2 bytes												
14	High 2 bytes												

Address	Data element	Data type	Access	Offset	Description
	Measured value 7	Float32			Measured value parameterized in advance via web interface.
				15	Low 2 bytes
				16	High 2 bytes
	Measurement rate	Float32			Measurement rate
				17	Low 2 bytes
				18	High 2 bytes
	Time stamp (s)	UInt32			Value of the time stamp (s) of the most recent measured values.
				19	Low 2 bytes
				20	High 2 bytes
	Time stamp (μ s)	UInt32			Value of the time stamp (μ s) of the most recent measured values.
				21	Low 2 bytes
				22	High 2 bytes
	Encoder value	UInt16		23	Encoder value of the connected encoder.

Address	Data element	Data type	Access	Offset	Description
401 (1 register)	Active Parameter Setup Number.	UInt8	Read	1	

Address	Data element	Data type	Access	Offset	Description
2500 ... 2515 (17 registers)	All Measurement Values		Read		
	Status	UInt16		0	Status <ul style="list-style-type: none"> Bit 0 Parametrisation mode is active. Bit 1 Time synchronised with NTP server. Bit 2 Valid values (measured values allow for interpretation). Bit 3 Alarm enabled.
	Quality	UInt8		1	Quality information on the current measured values. <ul style="list-style-type: none"> 0 OK 1 Weak signal. 2 No signal.

Address	Data element	Data type	Access	Offset	Description
	Output	UInt8		2	Outputs
Bit 0					Status of binary output 1.
Bit 1					Status of the alarm output Status of binary output 2.
	Measured value 1 ¹	Int16		3	Measured value parameterized in advance via web interface.
	Measured value 2 ¹	Int16		4	Measured value parameterized in advance via web interface.
	Measured value 3 ¹	Int16		5	Measured value parameterized in advance via web interface.
	Measured value 4 ¹	Int16		6	Measured value parameterized in advance via web interface.
	Measured value 5 ¹	Int16		7	Measured value parameterized in advance via web interface.
	Measured value 6 ¹	Int16		8	Measured value parameterized in advance via web interface.
	Measured value 7 ¹	Int16		9	Measured value parameterized in advance via web interface.
	Measurement rate (Hz) ¹¹	Int16		10	Measurement rate
	Time stamp (s)	UInt32			Value of the time stamp (s) of the most recent measured values.
11				Low 2 bytes	
12				High 2 bytes	
	Time stamp (µs)	UInt32			Value of the time stamp (µs) of the most recent measured values.
13				Low 2 bytes	
14				High 2 bytes	
	Encoder value	UInt16		15	Encoder value of the connected encoder.
		UInt16		16	Reserve

¹ Divide the received measured value by 100 to obtain the result in the physical measuring unit.

¹¹ Divide the received measuring rate by 10 to obtain the measuring rate in Hz.

5.4 OPC UA

OPC UA (Open Platform Communications United Architecture) is an open interface standard, which was developed specifically for the requirements of automation technology. An increasing number of controls and systems already support the required client functionality. Various software libraries are available for PC-based systems. Additional information can be found on the website of the OPC foundation. Visit the following website: <https://opcfoundation.org>

For information regarding the commissioning of OPC UA, see [OPC UA: Add sensor in client UaExpert \[OXM / OXS\] | 74](#).





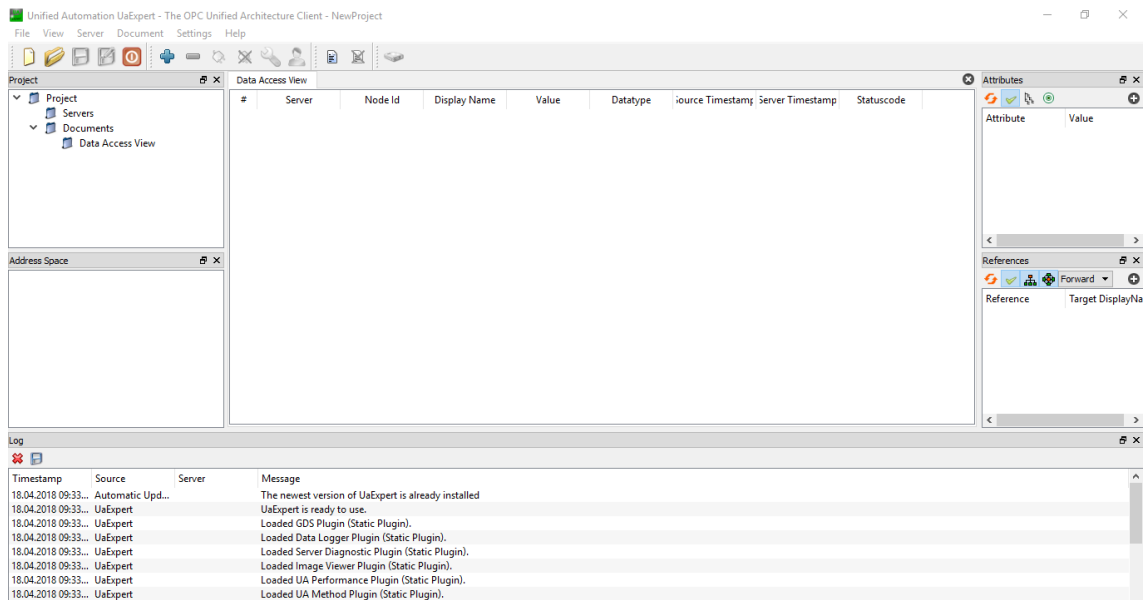

INFO

The example in this section refers to the use of the free-of-charge OPC UA client *UaExpert*. You can obtain the software following prior registration at <https://www.unified-automation.com>. Of course, the sensor can also be configured using the software of other manufacturers and their controls. The steps must then be carried out correspondingly.



III. 13: OPC UA – UaExpert Client – Surface

	■ Node
	■ Variable node (partial read/write)
	■ Variable node (characteristic or property)
	■ Method node (action with call)

Identification The following table provides an overview of the **Identification** folder in the function tree.

OPC UA command	Sensor command
ProductId	Item/order number of the sensor

Lock

The following table provides an overview of the **Lock** folder in the function tree.

OPC UA command	Sensor command
BreakLock	Not implemented.
ExitLock	Deactivate parametrisation mode.
InitLock	Unlock the sensor (initiate the parametrisation mode).
Locked	Indicates whether the sensor is currently in the parametrisation mode.
LockingClient	Specifies which interface was used to set the sensor to parametrisation mode.
LockingUser	Not implemented.
RemainingLockTime	Not implemented.
RenewLock	Not implemented.

Measurement

The following table provides an overview of the **Measurement** folder in the function tree.

OPC UA command	Sensor command
AlarmOutput	Alarm output active (yes/no)
ConfigModeActive	The measured value was determined when the sensor was in parametrisation mode.
EncoderValue	Value of the connected encoder
MeasurementRate	Measurement rate (in Hz)
MeasurementValue1	Measured value 1
MeasurementValue2	Measured value 2
MeasurementValue3	Measured value 3
MeasurementValue4	Measured value 4
MeasurementValue5	Measured value 5
MeasurementValue6	Measured value 6
MeasurementValue7	Measured value 7
Quality	Signal quality: <ul style="list-style-type: none"> ▪ 0 = good signal (valid) ▪ 1 = weak signal (unsafe) ▪ 2 = no signal (invalid)
SwitchingOutput1	Switching output 1 active (yes/no)
SwitchingOutput2	Switching output 2 active (yes/no)
TimeStampSec	Time stamp of the measurement (in s)
TimeStampUSec	Time stamp of the measurement (in μ s)
TimeSynchronised	Time synchronization active (yes/no)
MeasurementValuesBlock	Last 100 measured values. In the case of new measured values, the oldest measured value disappears.

MethodSet The following table provides an overview of the **MethodSet** folder in the function tree.

OPC UA command	Sensor command
LoadParameterSetup	Load stored parameter setup 1-32. The value 1-32 must be given.
SetLaserState	For laser sensor on/off.

ParameterSet The following table provides an overview of the **ParameterSet** folder in the function tree.

OPC UA command	Sensor command
ActiveParameterSetupNumber	Shows the currently active parameter setup.
LaserState	Shows the current laser status.
MeasurementValues	Shows all current measured values.
MeasurementValuesBlock	Shows the last 100 measured values.
ProductId	Shows item / order number.

Parameter-Setup The following table provides an overview of the **ParameterSetup** folder in the function tree.

OPC UA command	Sensor command
ActiveParameterSetupNumber	Shows the currently active parameter setup.
LoadParameterSetup	Load the parameter setup selected by the user.

Unlock the sensor

To carry out settings on the sensor, it must be unlocked first. For this process, proceed as follows:

Instruction:

- a) Open the function tree of the sensor in the **Address Space** window.
- b) In the structure of the function tree, navigate to **Root | Objects | Device Set | OX-Line | Lock | InitLock**.
- c) In the context menu (right-click **InitLock**) select the option **Call**.
- d) In the **Call InitLock on Lock** window, confirm with **Call**.

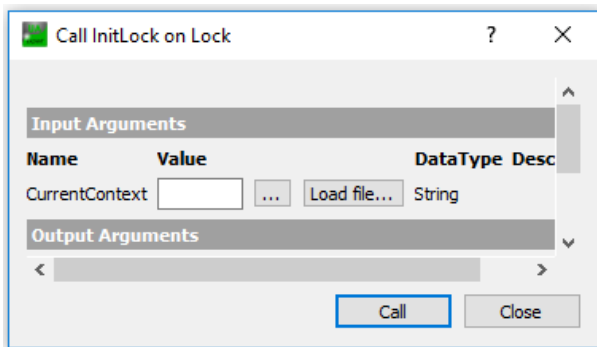

Reading out the measured value

- a) Open the function tree of the sensor in the **Address Space** window.
- b) In the structure of the function tree, navigate to **Root | Objects | Device Set | OX-Line | Measurement**.
- c) In the structure, mark the measured value that should be read out.
 - ✓ The associated attributes are displayed in the **Attributes** window.
 - ✓ The measured value is located in the **Value** line.
- d) Click the **Refresh** button to update the attributes.

Changing the active parameter setup

Condition:

- ⇒ The sensor is unlocked (parametrisation mode).
- a) Open the function tree of the sensor in the **Address Space** window.
- b) In the structure of the function tree, navigate to **Root | Objects | Device Set | OX-Line | ParameterSetup | LoadParameterSetup**.
- c) In the context menu (right-click **LoadParameterSetup**), select the option **Call**.
- d) Enter the desired parameter setup in the **Call LoadParameterSetup on ParameterSetup** window in the field **Value**.

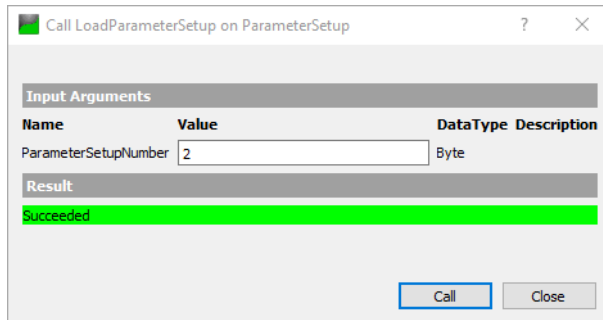

- e) Confirm with **Call**.

5.5 IO-Link

The sensor supports communication via IO-Link. Cyclic process data and status information can be transferred via this process. Device supports transmission rate according to COM 3 of the IO-Link specification.

You can either use the setup parameters stored in the sensor or the web interface-programmed setup parameters (see [Mode Save Parameter-Setups ▶ 102](#)). Further parametrisation of measurement-relevant parameters via IO-Link is not possible. The order of the measured results is defined by the order specified in the web interface (see [Mode Measurement Tools Parametrization ▶ 95](#)).

During data transfer, a distinction is made between cyclic data and acyclic data:

Cyclic data

Cyclic data transmission implicates the measured values parameterized via web interface (up to 5 values), encoder position (if encoder input available) as well as reserved and the following binary signals:

- Alarm output
- Quality bit (signals a weak signal)
- Switching states of the switching outputs
- Status information whether sensor is in parameterization mode
- Information whether time has been synchronized

Subindex	Bit offset	Data type	Name
bit length: 256			
data type: 256-bit Record (subindex access not supported)			
1	224	Float32	Measurement value 0
2	192	Float32	Measurement value 1
3	160	Float32	Measurement value 2

Subindex	Bit offset	Data type	Name
4	128	Float32	Measurement value 3
5	96	Float32	Measurement value 4
6	64	UInt32	TimeStampSec
7	32	UInt32	TimeStampUSec
8	16	UInt16	Encoder value
9	8	UInt8	Unused
10	6	Boolean	Values are valid
11	4	Boolean	Config mode is active
12	3	Boolean	Alarm Bit
13	2	Boolean	Quality Bit
14	1	Boolean	Binary Out 2
15	0	Boolean	Binary Out 1

Tab. 1: ProcessDataIn "Process Data In" id=PI_ProcessDataIn

Acyclic data

The measured values 1 to 7 parameterized via web interface, the sensor measuring rate and any other available information (see IODD) are transmitted as acyclic data.

Receiving data block for all measured values

Subindex	Bit offset	Data type	Name	Description
Data Type: 392-bit Record (subindex access not supported)				
Access Rights: R				
1	384	Boolean	ConfigModeActive	Config mode is active
2	376	Boolean	TimeIsSynched	Time is synchronized to NTP
3	368	Boolean	ValuesAreValid	Values are valid
4	360	Boolean	AlarmActive	Alarm is active
5	352	UInt8	QualityValue	Quality value
6	344	Boolean	BinaryOut1	Binary Out 1
7	336	Boolean	BinaryOut2	Binary Out 2
8	304	Float32	MeasurementValue0	Measurement value 0
9	272	Float32	MeasurementValue1	Measurement value 1
10	240	Float32	MeasurementValue2	Measurement value 2
11	208	Float32	MeasurementValue3	Measurement value 3
12	176	Float32	MeasurementValue4	Measurement value 4
13	144	Float32	MeasurementValue5	Measurement value 5
14	112	Float32	MeasurementValue6	Measurement value 6
15	80	Float32	MeasRateHz	Measurement rate in Hz
16	48	UInt32	TimeStampSec	Time Stamp of last measurement (seconds)
17	16	UInt32	TimeStampUSec	Time Stamp of last measurement (micro seconds)
18	0	UInt16	EncoderValue	Encoder value

Tab. 2: Variable "All Measurement Values" index=1025 id=V_MeasurementValues

Variables to read/load the parameter setup

Index	Name	Data type	Access rights	Description
82	Variable "Active Setting"	UInt8	R	Reading the active parameter setup <ul style="list-style-type: none"> ▪ 1 = Setting 1 is active ▪ 2 = Setting 2 is active ▪ ... ▪ 31 = Load Setting 31 ▪ 32 = Load Setting 32
999	Variable "Profile Commands"	UInt8	W	Loading parameter setup <ul style="list-style-type: none"> ▪ 0 = Load Setting 1 ▪ 1 = Load Setting 2 ▪ ... ▪ 30 = Load Setting 31 ▪ 31 = Load Setting 32

5.6 UDP

The sensor is equipped with a UDP interface, which makes it possible to stream measured values as well as profile and intensity data from the sensor. UDP (User Datagram Protocol) is a connectionless and unsecured protocol that is based on the Internet Protocol (IP) network protocol.

You can carry out the following settings via the web interface of the sensor:

- Desired measured values and data.
- IP address to which the measured values and data should be transferred.

**INFO**

If you want to stream data from several sensors to the same target, you must configure different target ports. If you have problems receiving data in your user-defined application, please check whether the firewall could block incoming UDP packets.

In the following example, only profile data is issued (no measured values). The "IP address" is the address of the adapter or the port where the sensor is connected. Please follow the instructions in [Allocating an IP address to the PC \[▶ 58\]](#) to allocate an IP address to the adapter or port.

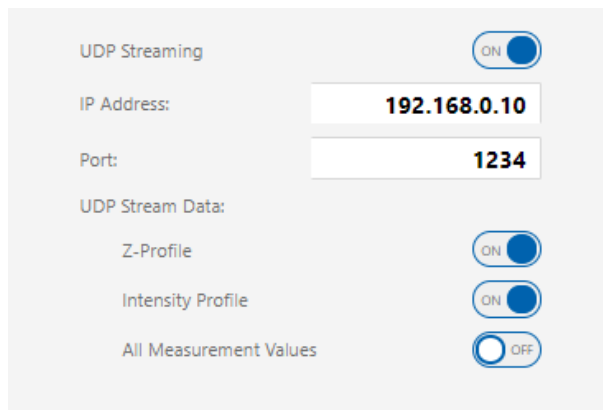

III. 14: Web interface – Mode Outputs Parametrization – UDP

The data transferred via the UDP consists of a header and a body, whereby the body varies depending on the transferred data. A UDP packet can be distributed over several frames. If only measured values and no profile data are transferred, only one frame is issued at a time. If the sensor transmits a profile divided into several packets, the first frame provides the total number of the related packets in the **FrameCount** field.

UDP header The following table provides an overview of the UDP header.

Field name	Offset	Data type	Description
BlockId	0	UInt32	Incremented with each UDP packet block sent (profiles can be sent in several UDP packets in one block).
FrameType	4	UInt8	0 = SingleFrame 1 = FirstFrame 2 = ConsecutiveFrame For measured values (MessageType = 0) always 0, as these fit in a single UDP packet.
Reserved	5	UInt8	
FrameCount / Index	6	UInt16	If FrameType = 1, then number of UDP packets in a block. If FrameType = 2, then position of the current UDP packet in the block.

Field	Block ID	Type	Res	Count	Body
Offset	0	4		6	8
Unfragmented data					
Single Frame	0x0A 0x00 0x00 0x00	0x00	0x00	0x00 0x00	D0 Dn
Fragmented data					
First Frame	0x0A 0x00 0x00 0x00	0x01	0x00	0x04 0x00	D0 Dn
Consecutive Frame	0x0A 0x00 0x00 0x00	0x02	0x00	0x01 0x00	Dn+1 Do
Consecutive Frame	0x0A 0x00 0x00 0x00	0x02	0x00	0x02 0x00	Do+1 Dp
Consecutive Frame	0x0A 0x00 0x00 0x00	0x02	0x00	0x03 0x00	Dp+1 Dq

III. 15: UDP – Packet framing example

Field	Type	Type dependant data
Offset	0	1
Unfragmented data	D0 Dn
Fragmented data	D0 Dn Dn+1 Do Do+1 Dp Dp+1 Dq

III. 16: UDP – Body recomposition example

UDP body

The following table provides an overview of the UDP body.

The content of the UDP body depends on the **MessageType** field.

MessageType: Measured values

Field name	Offset	Value	Data type	Description
MessageType	0	0	UInt8	0 = Measured values 1 = Z profile 2 = I profile 3 = Z-I profile
ConfigMode active	1		Bool	
Time is synced by NTP	2		Bool	
Values are valid	3		Bool	
Alarm	4		Bool	
Quality	5		UInt8	
Switching Output 1	6		Bool	
Switching Output 2	7		Bool	
MeasurementValue1	8		Float32	The content and order of the measured values corresponds to the order in the measured value array.
MeasurementValue2	12		Float32	
MeasurementValue3	16		Float32	
MeasurementValue4	20		Float32	

Field name	Offset	Value	Data type	Description
MeasurementValue5	24		Float32	
MeasurementValue6	28		Float32	
MeasurementValue7	32		Float32	
MeasurementRateHz	36		Float32	
TimestampSeconds	40		UInt32	
TimestampMicroSeconds	44		UInt32	
EncoderPosition	48		UInt16	

MessageType: Z profile

Field name	Offset	Value	Data type	Description
MessageType	0	1	UInt8	0 = Measured values 1 = Z-profile 16bit 2 = I-profile 16bit 3 = Z-I-profile 16bit 129 = Z-profile 32bit 130 = I-profile 32bit 131 = Z-I-profile 32bit
ConfigMode active	1		Bool	
Time is synced by NTP	2		Bool	
Values are valid	3		Bool	
Alarm	4		Bool	
Quality	5		UInt8	
MeasurementRateHz	6		Float32	
TimestampSeconds	10		UInt32	
TimestampMicroSeconds	14		UInt32	
EncoderValue	18		UInt16	
ProfileLength	20		UInt32	Number of profile points.
Profile_x_coordinate_[0]	24		Int16/ Int32	
Profile_z_coordinate_[0]	26 (16Bit)/ 28 (32Bit)		UInt16/ UInt32	
...				
Profile_x_coordinate_[n]	24 + (a × n)		Int16/ Int32	a = 4 (16Bit) oder a = 8 (32Bit) n = ProfilLength - 1
Profile_z_coordinate_[n]	24 + (a × n) + z		UInt16/ UInt32	z = 2 (16Bit) or z = 4 (32bit)

MessageType: I profile

Field name	Offset	Value	Data type	Description
MessageType	0	2	UInt8	0 = Measured values 1 = Z-profile 16bit 2 = I-profile 16bit 3 = Z-I-profile 16bit 129 = Z-profile 32bit 130 = I-profile 32bit 131 = Z-I-profile 32bit
ConfigMode active	1		Bool	
Time is synced by NTP	2		Bool	
Values are valid	3		Bool	
Alarm	4		Bool	
Quality	5		UInt8	
MeasurementRateHz	6		Float32	
TimestampSeconds	10		UInt32	
TimestampMicroSeconds	14		UInt32	
EncoderValue	18		UInt16	
ProfileLength	20		UInt32	Number of profile points.
Profile_x_coordinate_[0]	24		Int16/ Int32	
Profile_Intensity_[0]	26 (16Bit)/ 28 (32Bit)		UInt16/ UInt32	
...				
Profile_x_coordinate_[n]	24 + (a × n)		Int16/ Int32	a = 4 (16Bit) or a = 8 (32Bit) n = ProfilLength - 1
Profile_Intensity_[n]	24 + (a × n) + z		UInt16/ UInt32	z = 2 (16Bit) or z = 4 (32bit)

MessageType: Z I profile

Field name	Offset	Value	Data type	Description
MessageType	0	3	UInt8	0 = Measured values 1 = Z-profile 16bit 2 = I-profile 16bit 3 = Z-I-profile 16bit 129 = Z-profile 32bit 130 = I-profile 32bit 131 = Z-I-profile 32bit
ConfigMode active	1		Bool	
Time is synced by NTP	2		Bool	
Values are valid	3		Bool	
Alarm	4		Bool	

Field name	Offset	Value	Data type	Description
Quality	5		UInt8	
MeasurementRateHz	6		Float32	
TimestampSeconds	10		UInt32	
TimestampMicroSeconds	14		UInt32	
EncoderValue	18		UInt16	
ProfileLength	20		UInt32	Number of profile points.
Profile_x_coordinate_[0]	24		Int16/ Int32	
Profile_z_coordinate_[0]	26 (16Bit)/ 28 (32Bit)		UInt16/ UInt32	
Profile_Intensity_[0]	28 (16bit)/ 32 (32bit)		UInt16/ UInt32	
...				
Profile_x_coordinate_[n]	24 + (a × n)		Int16/ Int32	a = 6 (16Bit) or a = 12 (32Bit) n = ProfilLength - 1
Profile_z_coordinate_[n]	24 + (a × n) + z		UInt16/ UInt32	z = 2 (16Bit) or z = 4 (32bit)
Profile_Intensity_[n]	24 + (a × n) + z		UInt16/ UInt32	z = 4 (16Bit) or z = 8 (32bit)

5.7 SDK

A SDK (software development kit) for the sensor is available. The SDK allows you convenient sensor integration into your application. However, the SDK does not offer all the sensor parametrization options of the web interface, i.e. no parameterization of smart functions (tools). For the OXP sensor version, full operation is possible.

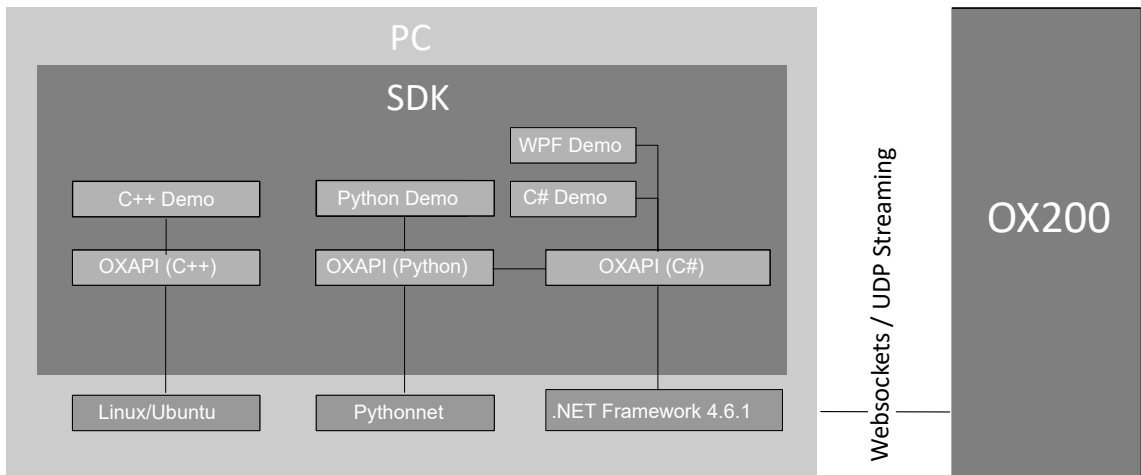

III. 17: SDK – Structure

Scope of delivery, compatibility and deployment



INFO

The SDK, incl. sample projects is available for download at www.baumer.com/OX200 (as a ZIP archive).

The SDK comprises a .NET DLL (OXApi.dll) with its dependencies appropriate for integration into .NET- / C#- / VB environment (.NET 4.6.1 or higher).

The SDK for C++ comprises the OXApi.dll and requires *Ubuntu 18.04 LTS* (or higher) and Boost 1.7 (or higher), and its dependencies.

For use with Python, a wrapper is included (oxpapi.py), which requires the installation of python-net 2.4.0 or later (<https://pypi.org>).

There are also several sample projects available that show how to use the SDK in C#, C++ and Python. These were created with *Visual Studio 2017* and/or with *Eclipse* and a CDT plugin.

Scope of functions

The following table provides an overview of the commands and functions supported by the SDK:

Function	Set	Get
FieldOfView	-	GetFieldOfViewInfo
	-	GetFieldOfViewLimits
	ConfigureFieldOfView	GetFieldOfView
	ConfigureFieldOfViewDistance	GetFieldOfViewDistance
Interfaces	ConfigureNetwork	GetNetworkConfiguration
	ConfigureProcessInterfaces	GetProcessInterfaces
	-	GetProcessInterfacesInfo
	-	GetUdpStreamingInfo
	ConfigureUdpStreams	GetActiveUdpStreams
	-	GetNumberOfTimeServers
	ConfigureTimeServer	GetTimeServerConfiguration
Meta	-	GetSensorInfo
ParameterSetup	LoadParameterSetup	GetActiveSetup
	ConfigureStartupSetup	GetStartupSetup
	-	GetParameterSetup
	-	GetNumberOfSetups
	StoreParameterSetup	-
	-	ReadAllSettings
	StartWriteSettings	-
	WriteSettingsBlock	-
	-	GetWriteSettingsBlockLimit
	WriteSettings	-
	FactoryReset	-
	ResetSettings	-
	ResetAllSettings	-

Function	Set	Get
Profiles	-	GetProfileInfo
	-	GetProfile
	-	GetIntensityProfile
ProfileConfiguration	ConfigureResampling	GetResamplingGridValue
	-	GetResamplingInfo
	ConfigureProfileFilter	GetProfileFilter
	-	GetProfileFilterLimits
	ConfigureProfileAlgorithm	GetProfileAlgorithm
	-	GetProfileAlgorithms
	-	GetProfileAlgorithmParam- sLimits
	-	GetProfileAlgorithmParamsInfo
	ConfigureProfileAlgorithmPara- meters	GetProfileAlgorithmParameters
	-	GetAxesInfo
ConfigureZAxis	GetZAxis	
RoleManagement	Login	-
DataAcquisition	SetExposureTime	GetExposureTime
	-	GetExposureTimeLimits
	-	GetExposureTimeResolution
	-	-
	ConfigureResolution	GetResolution
	-	GetResolutionInfo
LaserPower	ConfigureLaserPower	GetLaserPower
	-	GetLaserPowerInfo
	-	GetLaserPowerLimits
Trigger	Trigger	-
	ConfigureTrigger	GetTrigger
	-	GetTriggerLimits
	-	GetTriggerInfo
Measurement	-	GetMeasurement
	-	GetMeasurementInfo
	-	GetMeasurementValuesInfo
Image	-	GetImage
	-	GetImageInfo

5.8 Web interface

Web interface access is directly via web browser, so sensor configuration and operation does not require any additional software.

The web interface is a simple and yet precise way for sensor configuration. The web interface can be used for the configuration of sensor parameters as well as parametrisation of the application-specific measuring tasks. The web interface allows you to visualise what the sensor "sees", so you can use this information to precisely adjust the sensor to the given conditions.

For a detailed description of the web interface, the individual elements of the user interface and all required operating processes, see [Web interface \[▶ 77\]](#).

6 Operating functions

6.1 External triggering

With the external trigger, the sensor waits for an external signal that can be fed in via specific inputs.

There are two ways to trigger externally. Either via the external input of the signal at the input *IN 1 (sync in)*, see [Pin assignment](#) [▶ 55], or via field bus.

The external signal is used differently for triggering a measurement depending on the trigger mode. The measurement procedure for the individual measurement is described below.

Single Shot mode

In Single Shot mode, the sensor records exactly one measured value as soon as it is triggered by an external pulse. The recorded measured value is maintained at all outputs. The specification of the input *IN 1 (sync in)* can be found in the data sheet at www.baumer.com. The delay between the detection of a trigger and the start of a measurement is $< 25 \mu\text{s}$.

- The laser must be ON. If required, check the laser status at the applied interfaces.
- The sensor checks whether a trigger event is present before each measurement.
- As soon as the sensor detects a falling edge (transition from high level to low level), a measurement is triggered.
- The previous measuring cycle is always completed first, even if a high level is present at the input.
- The power of the laser beam is reduced during the waiting time (Hold).
- When input is on HIGH, there is a status freeze of every output function until the next measuring operation.
- For the next measuring operation of the sensor, the input must be at LOW for at least $25 \mu\text{s}$.

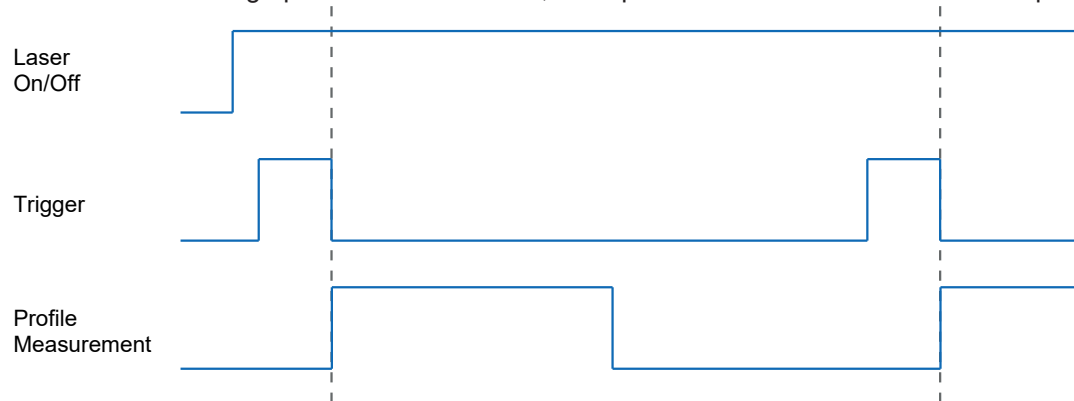

Example: Mutual influence

If the laser line of sensor 2 lies in the measurement field of sensor 1, the sensors may interfere with each other. If this interference cannot be prevented by appropriate mounting, the sensors can be operated asynchronously via trigger signal and trigger mode Single Shot. A higher-level controller must generate the signals for this. For further information, see [Set Trigger Mode](#) [▶ 89].

Continuous measuring modes

In these modes, sensor measurement is continuous at a defined interval or the maximum possible frequency. External trigger is to pause measuring.

Continuous / Interval / Encoder

- The laser must be ON. If required, check the laser status at the applied interfaces.
- The recorded measured value is maintained at all outputs.

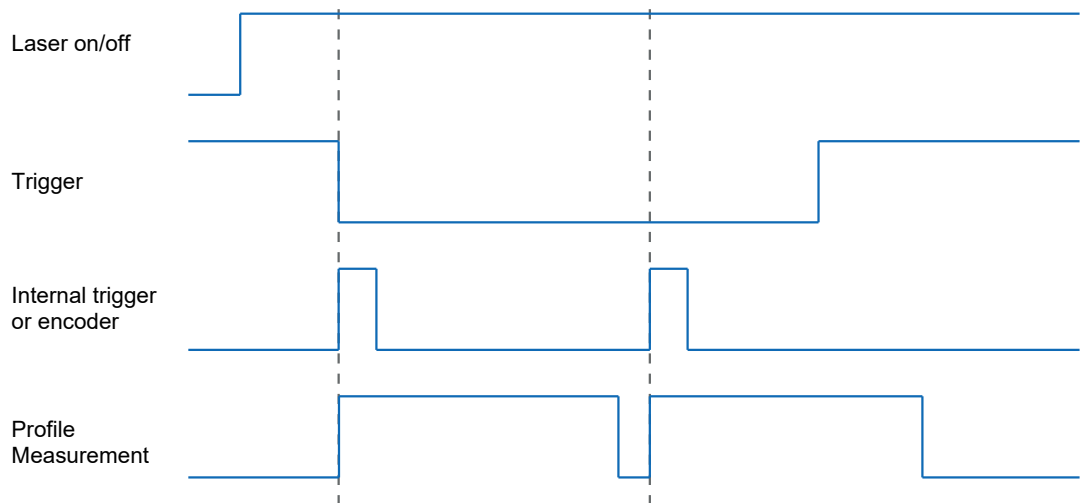

Encoder

If an encoder is connected to the sensor, the measured value recording can be triggered by the encoder steps.



INFO

Encoder inputs not connected and no connection to *GND*, may result in counting errors due to misinterpretation of ambient interference that is count as steps. This does not affect the sensor performance.

2-channel operation (with CH-A and CH-B)

With 2-channel operation, it is possible to detect the running direction of the belt. In this mode, each rising and falling edge of the signals corresponds to a pulse for the timing control of the device. The signals must occur alternately for channels CH-A and CH-B. Some encoders supply a reference pulse for the detection of a full revolution. The sensor cannot process this reference pulse.

NOTICE

For safe operation, the maximum frequency of the encoder signal specified on the data sheet must not be exceeded. The sensor can process a minimum step width of 3.

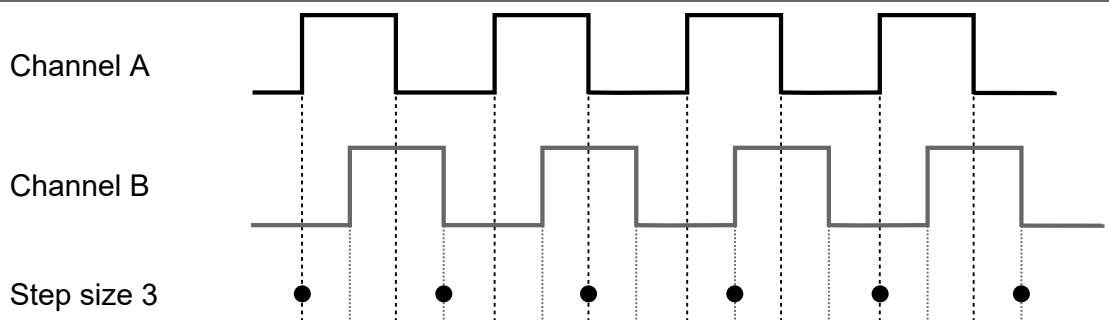

III. 18: Encoder – 2-channel operation

6.2 Changing the parameter setup with Profinet and Ethernet/IP

Successful loading of parameter setup

The following diagram is an example timeline for loading a new parameter setup without error:

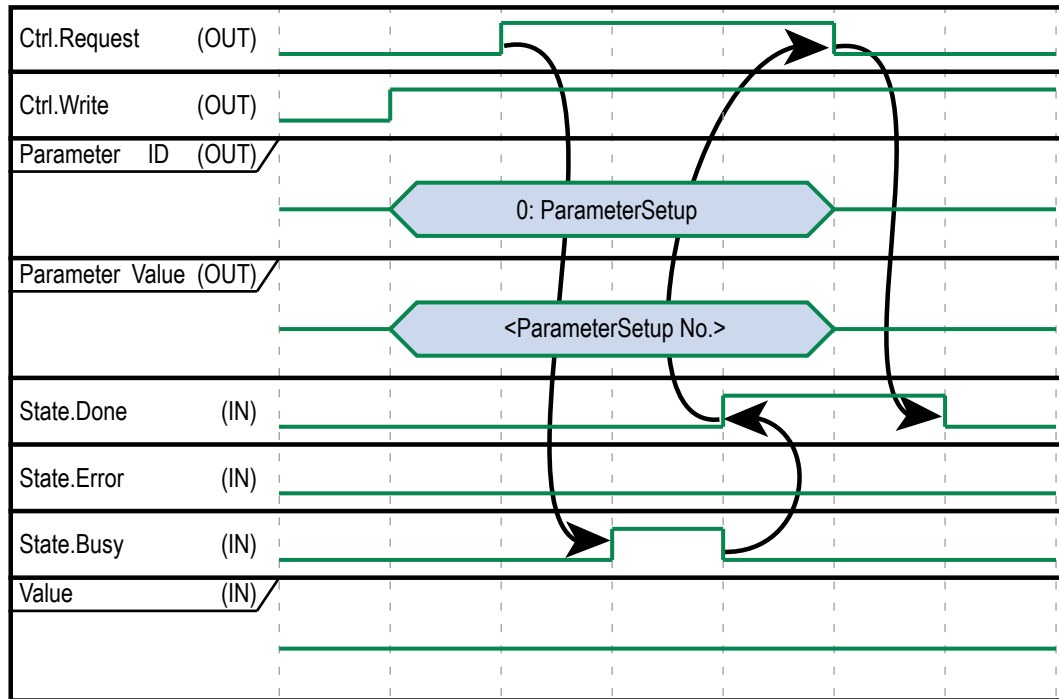

III. 19: Load new Parameter Setup (success)

- Using *Parameter ID (OUT)* = 0 the sensor is requested to change the parameter setup (see table Function ID).
- *Parameter Value (OUT)* defines the Parameter-Setup to load.
- These two inputs must be set prior to starting the event (*Ctrl. Write*).
- *State.Done* (parameterization status IN.Bit0) reports successful loading of parameter setup.

Incorrect loading of parameter setup

The following diagram is an example timeline for loading a new parameter setup with error:

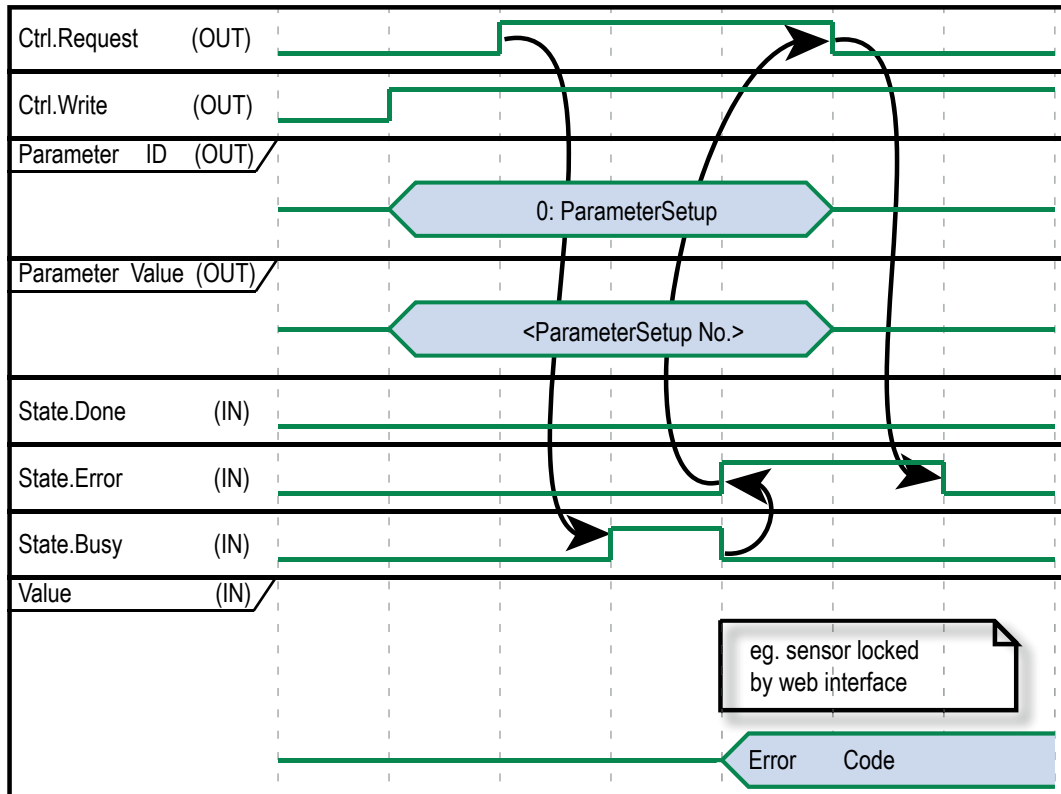

III. 20: Load new parameter setup (error)

- Using *Parameter ID (OUT)* = 0 the sensor is requested to change the parameter setup (see table Function ID).
- *Parameter Value (OUT)* defines the Parameter-Setup to load.
- These two inputs must be set prior to starting the event (*Ctrl. Write*).
- The sensor being unable to load the Parameter-Setup will set *State.Error* (parameterization state IN.Bit2). Error code communication is with *Parameter-value IN*
- Common reason for error: The sensor is blocked by the web interface.

7 Transport and storage

7.1 Transport

NOTICE

Material damage due to improper transport.

- a) Ensure maximum diligence when unloading the delivered packages as well as when transporting them inside the company.
- b) Note the information and symbols on the packaging.
- c) Only remove packaging immediately before mounting.

7.2 Delivery inspection

Upon receipt immediately inspect the delivery for completeness and transport damage.

Claim any defect as soon as it is detected. Damages can only be claimed within the applicable claims deadlines.

In case of externally visible transport damage, proceed as follows:

Instruction:

- a) Do not accept the delivery or only with reservations.
- b) Note the scope of the damage on the transport documents or the delivery slip of the carrier.
- c) Initiate the claim.

7.3 Storage

Store the product at the following conditions:

- Only transport or store the device in its original packaging.
- Do not store outdoors.
- Store dry and free from dust.
- Do not expose to aggressive media.
- Keep away from the sun.
- Avoid mechanical agitation.
- Storage temperature: .
- Ambient humidity:.
- When storing for longer than 3 months, regularly check the general state of all parts and the packaging.

8 Installation

8.1 General information for mounting

- Recommended installation: The sensor's reference level R2 aligned in parallel towards the surface to be measured
- If required, the optimal alignment of the sensor can be graphically supported by the mounting assistant in the web interface.
- Angled mounting within a max. 30° angle (between the sensor's reference level R1 versus the surface to be measured). For doing so, activate in mode **Parametrization | Global Parametrization | Field of View** function **Flex Mount** (see [Flex Mount: Compensating mounting angles \[► 91\]](#)).
- Objects suitable for measurements using the light-section technology have a bright, diffuse and reflecting surface, for example, matt white or grey. A glossy surface can result in unstable and/or imprecise measured values, depending on angle and degree of reflection.
- To eliminate any measuring errors by scattered light, the background should be dark, e.g. a matt black.
- Power is supplied via:
 - Ethernet connection (if Power-over-Ethernet infrastructure is available), or
 - electrical connection (12-pin M12, A-encoding, male).

8.2 Mounting the sensor

Lateral sensor mount



III. 21: OX200 - lateral mount

Condition:

- ⇒ M4×40 screws (2 pc).
- ⇒ Matching washers (preferably toothed to penetrate the anodized layer of the sensor housing).

Instruction:

- ◆ Screw the sensor in place.
Max. torque 1.2 Nm.

Mounting the sensor at the head end



III. 22: OX200 – head mounting

For head end mounting, the sensor features 2 dowel holes 3.05×4 mm (**1** in the following figure) and 1 tapped hole M4×6 (**2**).

9 Electrical installation

NOTICE

Device damage due to faulty power supply.

The device can be damaged due to faulty power supply.

- a) Operate the device only with protected low voltage and safe electrical isolation of protection class III.

NOTICE

Device damage or unintended operation due to work on live parts.

Any wiring work on live parts may lead to unintentional operation.

- a) Prior to performing any wiring work disconnect power supply.
- b) Only connect or disconnect any terminals when not live.

9.1 Pin assignment



INFO

The pin assignment described below is a maximum configuration. For the precise pin assignment of your sensor, please see the data sheet that is available for download at www.baumer.com/OX200.

Ethernet connection

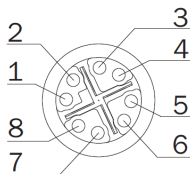

III. 23: Ethernet connection, M12 8-pin, X-coded, female

1	RX+	2	RX-
3	TX+	4	TX-
5	-VDC	6	-VDC
7	+VDC	8	+VDC

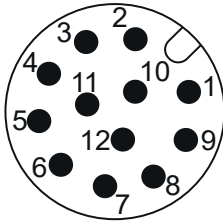
Electrical connection for the OXM version

III. 24: OXM200 – Electrical connection, M12 12-pin, A-coded, male

1	Power (18 ... 30 VDC) / IO-Link P24 (2L+)	2	GND / IO-Link N24 (2M)
3	Encoder A	4	Analog Out
5	Encoder A neg.	6	OUT 1 / IO-Link C/Q
7	Encoder B	8	OUT 2
9	IN 1 (sync in)	10	Encoder B neg.
11	Power / IO-Link L+	12	GND /IO-Link L-

Pin 11 and pin 12 must be assigned even if not using IO-Link but *OUT 1*.

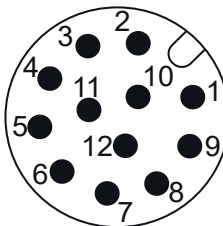
Electrical connection for the OXP version

III. 25: OXP200 – Electrical connection, M12 12-pin, A-coded, male

1	Power (18 ... 30 VDC)	2	GND
3	Encoder A	4	DNC
5	Encoder A neg.	6	OUT 1
7	Encoder B	8	DNC
9	IN 1 (sync in)	10	Encoder B neg.
11	Power (18 ... 30 VDC)	12	GND

It is recommended to connect the unused inputs and the cable shield to *GND (0V)*. Outputs designated as *NC* can be connected, but do not have to be. Outputs designated as *DNC* must remain open.

Any unused inputs and the cable shield must be connected to *GND (0V)*.

Wire colors according to DIN IEC 757

1	BN – Brown	2	BU – Blue
3	WH – White	4	GN – Green
5	PK – Pink	6	YE – Yellow
7	BK – Black	8	GY – Grey
9	RD – Red	10	VT – Violet
11	GY-PK – Grey Pink	12	RD-BU – Red Blue

9.2 Connecting the sensor to electricity

NOTICE

For sensor supply use either a power unit or a PoE switch. PoE switch must be compliant to Standard IEEE 802.3af.

Instruction:

- a) Ensure that the system is disconnected from power.
- b) Connect the sensor according to the pin assignment.

10 Commissioning

10.1 Connecting the sensor to the PC



INFO

Prerequisite for using the web interface is a web browser on your PC, *Mozilla Firefox* from Version 69 or *Google Chrome* from Version 77.

Internet Explorer is not supported in any version and cannot be used for connection to the sensor.

Microsoft Edge is not officially supported. However, in most cases it can be used without restrictions.

The following section describes how to connect the sensor to the PC. The prerequisites for this are that the DHCP is not active and the IP address of the PC is from the 192.168.0.XXX range. Otherwise, please follow the instructions under [Allocating an IP address to the PC](#) [58].

Condition:

- ⇒ The PC contains the web browser *Mozilla Firefox* from version 69 or *Google Chrome* from version 77.

Instruction:

- a) Start the web browser on your PC.
- b) Enter the IP address of the sensor in the address bar of the web browser.
The factory setting for the IP address is 192.168.0.250.

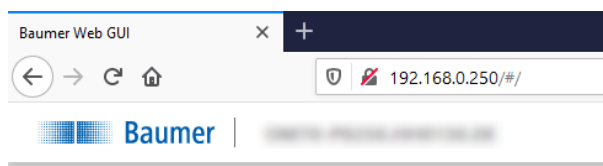

III. 26: Entering the IP address of the sensor

10.1.1 Allocating an IP address to the PC

NOTICE

Network errors due to multiple allocations of IP addresses.

- a) Make sure that each IP address within the network is unique and not already allocated.

The following section describes how to allocate a unique IP address to the PC. Prerequisite here is that the IP address of the sensor was not The prerequisite for this is that the IP address of the sensor has not been changed.changed.

Instruction:

- a) In Windows select **Start | System control | Network and Internet | show network status and tasks | edit adapter settings**.
✓ Window **Network Connections** opens.
- b) Click the symbol of the network adapter in use.
If you do not know the network adapter, remove the network cable of the sensor from the PC and observe which text changes in window **Network Connections**.
- c) In the context menu (right-click on icon) of the network adapter select **Properties**.

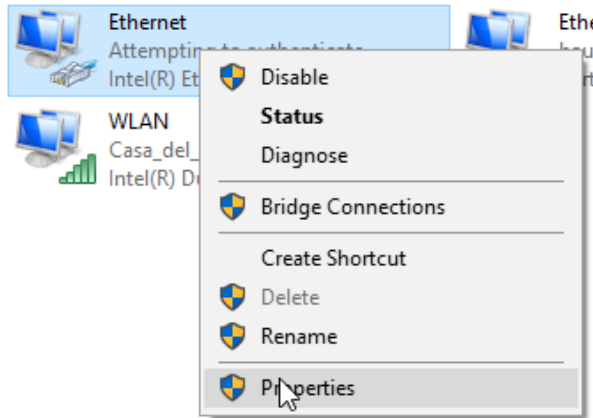

✓ Window **Properties of Ethernet** opens.

d) Tick checkbox **Internet Protocol Version 4 (TCP/IPv4)**.

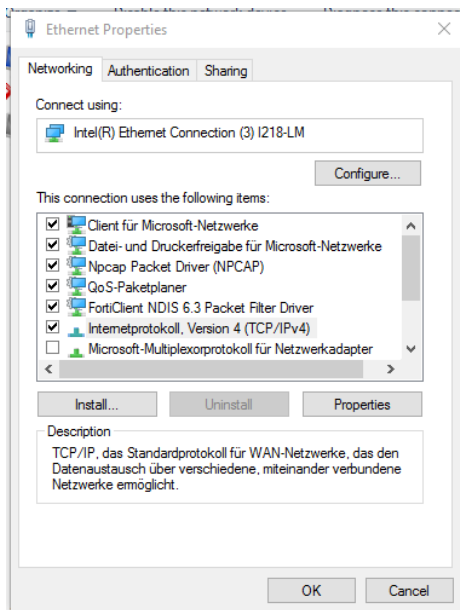

e) Click **Properties**.

✓ Window **Properties of Internet Protocol Version 4 (TCP/IPv4)** opens.

f) Under **Use following-IP-Address** enter the following parameters:

IP-Address: in the range from 192.168.0.1 to 192.168.0.254. Select an IP address that is not yet allocated in your network.

Subnet mask: 255.255.255.0.

g) Click **OK**.

Result:

✓ The PC has been allocated an IP address.

Also see about this

[Tracking the sensor's IP address \[▶ 60\]](#)

10.1.2 Tracking the sensor's IP address

Below is a description of how to determine the IP address of the sensor. This is required if the IP address was assigned via DHCP or the statically set IP address is no longer available. In general, there are 2 options for determining the IP address.

Option 1: IP address query via mDNS

Instruction:

- a) Open a browser.
- b) Enter the following command in the address bar of the browser:
`OXM200-[identifier].local`
Replace `[identifier]` with the eight-digit article number or with the MAC address stated on the sensor.
Replace `OXM200` with the part of the sensor denomination before the `-`.
Both are found on the silver label of the sensor.
Example: `OXM200-11218413.local` or `OXM200-11-22-33-44-55-66.local`

Result:

- ✓ The device opens the web interface.

Option 2: IP address query via ping command

- a) In Windows, select **Start | Search**.
- b) In the search bar, enter the value `cmd`.
 - ✓ The **Prompt** window opens.
- c) Enter the following command: `ping OXM200-[identifier].local`
Replace `[identifier]` with the eight-digit article number or with the MAC address stated on the sensor.
Replace `OXM200` with the part of the sensor denomination before the `-`.
Both are found on the silver label of the sensor.
Example: `ping OXM200-11218413.local` or
`ping OXM200-11-22-33-44-55-66.local`

Result:

- ✓ The IP address of the sensor is displayed (in the example: `192.168.0.250`):
"Pinging OXM200-12345678.local [192.168.0.250] with 32 bytes of data"

The sensor might not be accessible by PC though having entered the sensor's IP address. In this case, allocate a new IP address to your PC (see [Allocating an IP address to the PC](#) [▶ 58]). Make sure to allocate your PC an IP address that is close to the sensor's IP address, e.g.:

- IP address of PC: `192.168.0.251`
- IP address of sensor: `192.168.0.250`

10.2 Profinet: Integrate sensor in PLC [OXM / OXS]



INFO

The examples in this section refer to a *Siemens* control and the associated software *TIA Portal/Step7*. The illustrations in this document were created with *TIA Portal/Step7 v13 SP2*. Of course, the sensor can also be configured using the software of other manufacturers and their controls. The steps must then be carried out correspondingly.

Integration of the sensor into the PLC via Profinet takes place as follows:

1. Wire the sensor (see [Wiring the sensor \[OXM / OXS\] ▶ 61](#)).
2. Connect the sensor to the PLC (see [Connect sensor to PLC \[OXM / OXS\] ▶ 61](#)).
3. Integrate the sensor into the PLC project (see [Integrate sensor into the PLC project \[OXM / OXS\] ▶ 63](#)).

10.2.1 Wiring the sensor [OXM / OXS]

Observe the general rules for wiring Industrial Ethernet.

- The maximum cable length is 100 m.
- Use shielded cables for data transfer.
- In cable assembly ensure the cable shield being properly connected to the connector housing.

10.2.2 Connect sensor to PLC [OXM / OXS]

To connect the sensor to the PLC, proceed as follows:

Activate Profinet on the sensor

Profinet is deactivated as standard in the factory settings of the sensor. After connecting the sensor, go to the *Siemens* software (**Accessible Devices** dialogue) and check whether the sensor is visible. If the sensor is not visible, it could be due to the following reasons:

- Profinet is deactivated (factory settings).
- The Profinet device and the PLC are not in the same network.

To activate Profinet, proceed as follows:

Instruction:

- a) Open the web interface integrated in the sensor.
- b) In the menu, select the **Device Configuration** mode.
- c) Open the **Process Interface** tab.
- d) In the **Process Interface** window, open the drop-down list next to **Realtime Ethernet** and select **Profinet IO**.
- e) Select **Store to Sensor**.

NOTICE! After the sensor restarts, it has the IP address 0.0.0.0. You can then speak to the sensor only by means of an appropriate tool.
- f) Restart the sensor.

Result:

- ✓ Profinet is activated.
- ✓ The sensor has the IP address 0.0.0.0.
- ✓ The Profinet name of the sensor is set to the default value.
- ✓ Using a Profinet tool, the sensor can be allocated its Profinet name and, if required, its IP address. Connection to the PC is only possible after an IP address is allocated.

Installing General Station Description (GSD) files

After activating Profinet via the web interface of the sensor, you have to install the GSD file (product-specific driver) in the *Siemens* software. The GSD file describes the scope of the Profinet function in the device (e.g. the available modules) and is required for configuration.



INFO

The GSD file is available for download at www.baumer.com/OX200.

To install the GSD file, proceed as follows:

- a) Open the *Siemens* software.
- b) In the menu, select **Options | Manage general station description files (GSD)**.

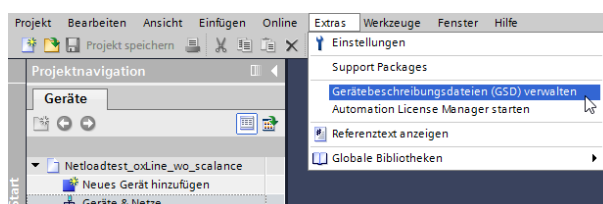

- c) Select the GSD file to be installed and click **Install**.

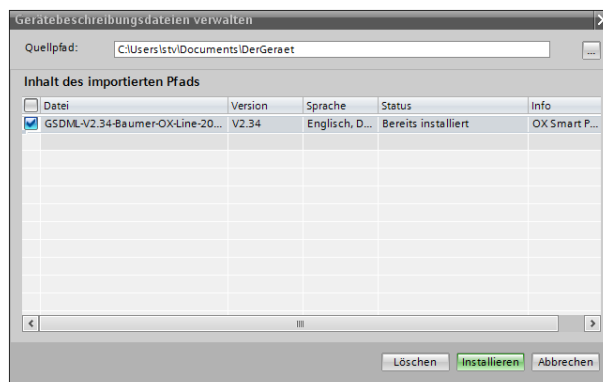

10.2.3 Integrate sensor into the PLC project [OXM / OXS]

After the GSD file has been installed, the sensor can be used in the PLC project. PLC configuration usually takes place independently of the actual connection in the network. Proceed as follows:

Instruction:

- a) Open the *Siemens* software.
- b) Open the **Hardware catalog** window.
- c) Mark the sensor in the **Hardware catalog** window, drag and drop it onto the Profinet subsystem and assign the sensor to the desired Profinet network group.

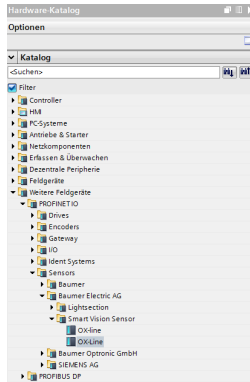

- d) In the **Devices and networks** window in the tab **Properties**, you can set the IP address, the cycle time and other interface options. The combination of slots and modules is already preset.

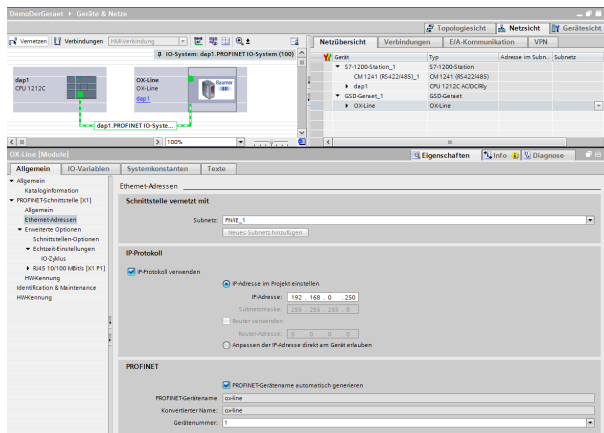

- e) If necessary, adjust the input address range of the data in the PLC process image and the name.

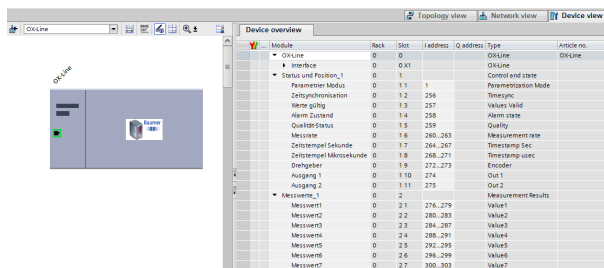

- f) Compile the project (1) and then load it onto the PLC (2), by clicking the following button:

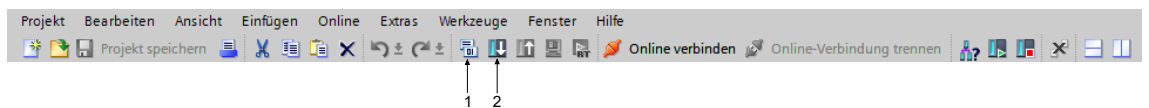

For more information about the Profinet interface, see [Profinet](#) [19].

10.2.4 Acyclic parameter change

You can change the parameter settings via the acyclic communication path. Most PLCs offer integrated functions for this.

Use the functions RDREC or WDREC to read or write acyclic data for a Siemens PLC and when working via the TIA Portal. Module 6 allows you to change the parameters cyclically via the parameter setup.

10.3 EtherNet/IP: Integrate sensor in PLC [OXM / OXS]



INFO

These examples refer to a *Rockwell* controller with associated software *Studio 5000 Logix Designer*. The illustrations in this document were made with version 29.00. Of course, also software or controllers of other manufacturers can be used for sensor configuration.

Integration of the sensor into the PLC via EtherNet/IP takes place as follows:

1. Wire the sensor (see [Wiring the sensor \[OXM / OXS\] \[p 64\]](#)).
2. Connect the sensor to the PLC (see [Connect sensor to PLC \[OXM / OXS\] \[p 64\]](#)).
3. Integrate the sensor into the PLC project (see [Integrate sensor into the PLC project \[OXM / OXS\] \[p 68\]](#)).

10.3.1 Wiring the sensor [OXM / OXS]

Observe the general rules for wiring Industrial Ethernet.

- The maximum cable length is 100 m.
- Use shielded cables for data transfer.
- In cable assembly ensure the cable shield being properly connected to the connector housing.

10.3.2 Connect sensor to PLC [OXM / OXS]

To connect the sensor to the PLC, proceed as follows:

Activating EtherNet/IP on the sensor

EtherNet/IP is deactivated as standard in the factory settings of the sensor. Check whether the sensor is visible after the sensor is connected in the *Rockwell* software (Dialogue **Communications | Who Active**).

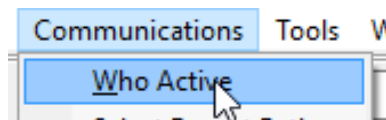

If the sensor is not visible, it could be due to the following reasons:

- EtherNet/IP is deactivated (factory settings).
- The EtherNet/IP device and the PLC are not in the same network.

To activate EtherNet/IP, proceed as follows:

Instruction:

- a) Open the web interface integrated in the sensor.

- b) In the menu, select the **Device Configuration** mode.
- c) Open the **Process Interface** tab.
- d) In the **Process Interface** window, open the drop-down list next to **Realtime Ethernet** and select **Ethernet/IP**.
- e) Select **Store to Sensor**.
- f) Restart the sensor.

Result:

- ✓ EtherNet/IP is activated.
- ✓ The sensor has the IP address 0.0.0.0.
- ✓ The IP address can be allocated to the sensor using an EtherNet/IP tool. Connection to the PC is only possible after an IP address is allocated.

Installing General Station Description (EDS) files

After activating EtherNet/IP via the web interface of the sensor, you have to install the EDS file (product-specific driver) in the *Rockwell* software. The EDS file describes the scope of the EtherNet/IP function in the device (e.g. the available modules) and is required for configuration.

**INFO**

The EDS file is available for download at www.baumer.com/OX200.

To install the EDS file, proceed as follows:

- a) Open the *Rockwell* software.
- b) In the **Tools** menu, select | **EDS Hardware Installation Tool**.

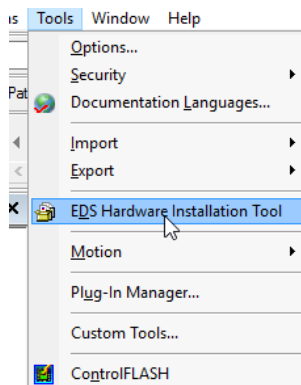

- ✓ The **Rockwell Automation's EDS Wizard** window opens.
- c) Click on **Continue**.

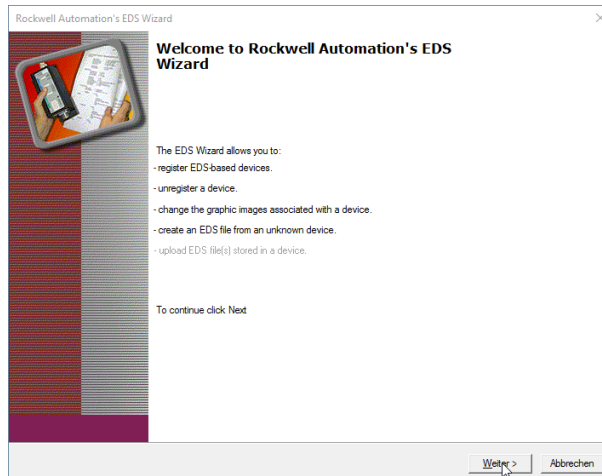

d) Select **Register an EDS file(s)** and click on **Continue**.

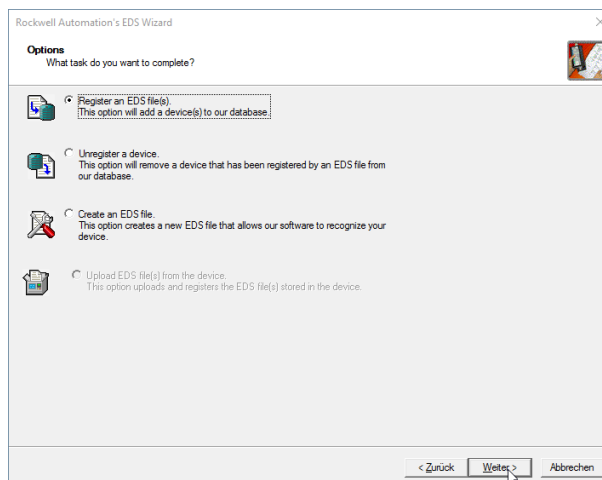

e) Navigate to the EDS file to be installed and select **Register a single file**. Click on **Continue**.

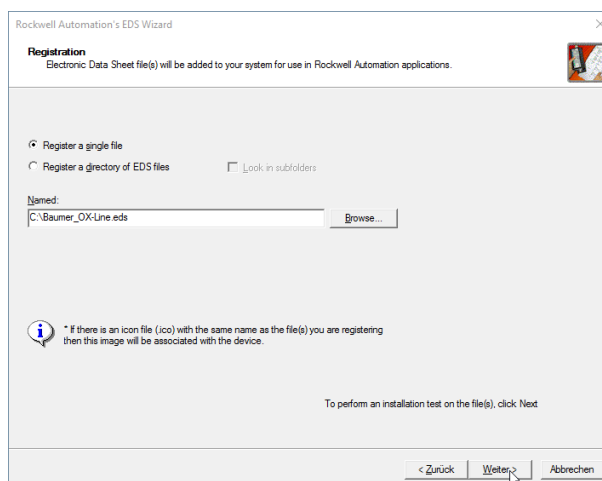

f) In the following dialogues, click on **Continue**.

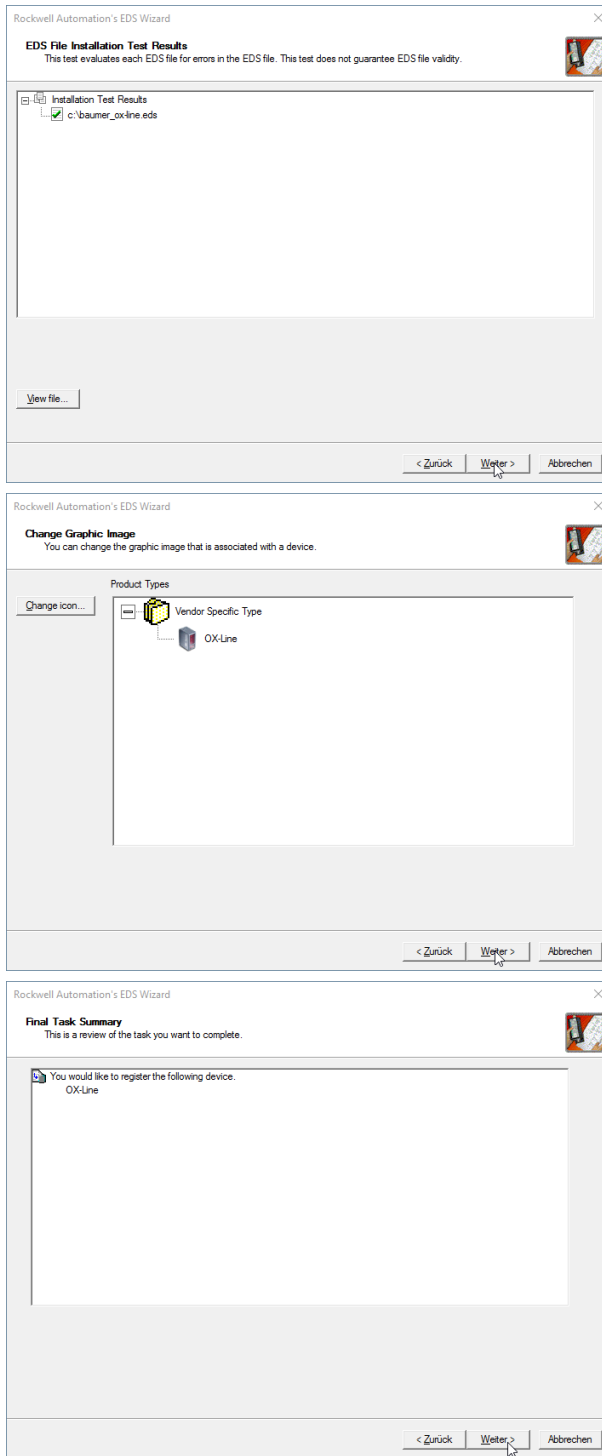
**Result:**

- ✓ The device description file (EDS) is now installed.

10.3.3 Integrate sensor into the PLC project [OXM / OXS]

After the EDS file has been installed, the sensor can be used in the PLC project. PLC configuration usually takes place independently of the actual connection in the network. Proceed as follows:

Instruction:

- a) Open the *Rockwell* software.
- b) Right click on **Ethernet**.
- c) Click on **New Module**.

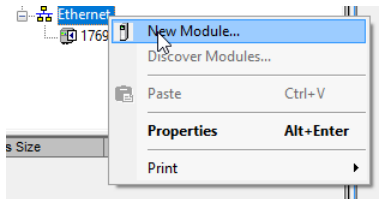

- d) Enter **OX** in the Find line and double-click on the entry for **OX-Line**.

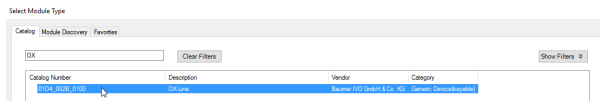

- e) In the **General** tab, enter the name and the IP address of the sensor.

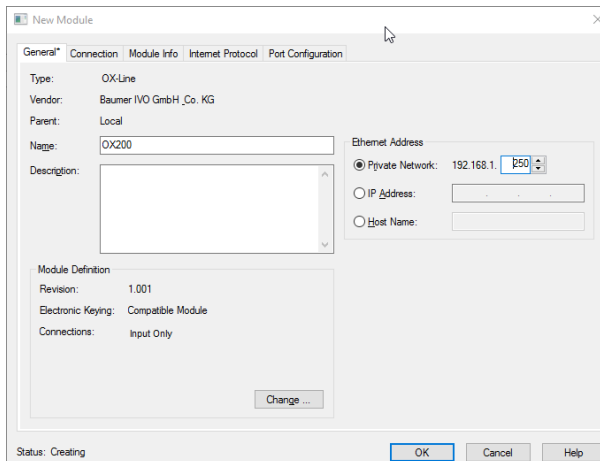

- f) In the **Connection** tab, set the desired cycle time (RPI) And click on **OK**.

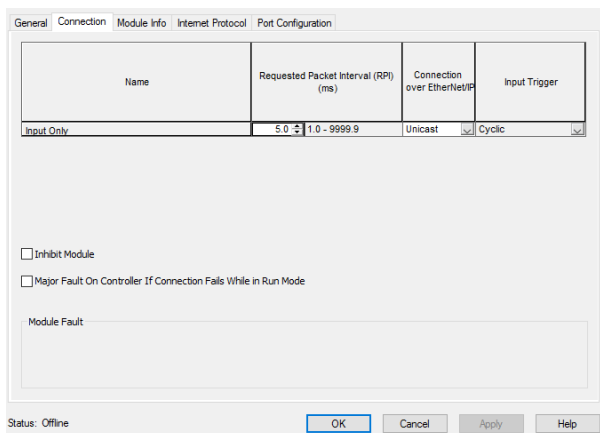

- g) To compile and load the project into the PLC, select the menu **Communications | Download**.

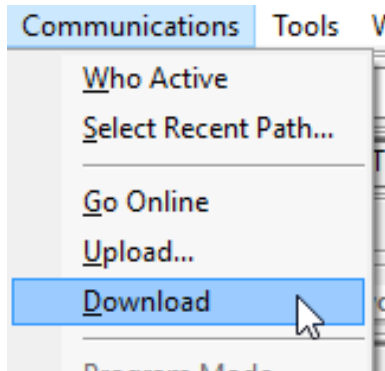

h) Click on **Download**.

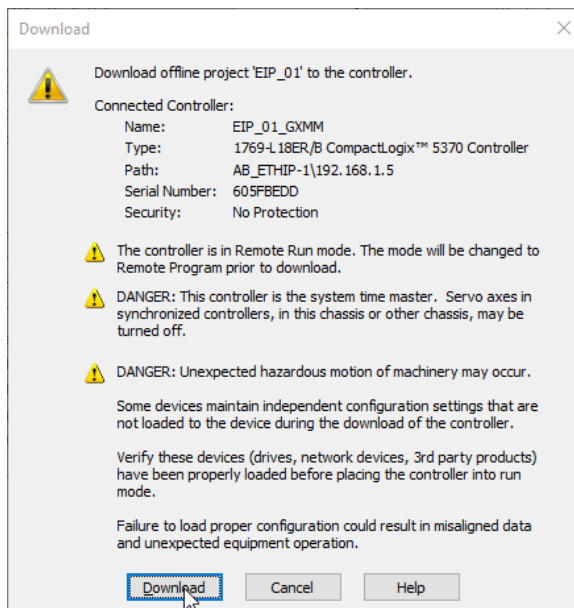

i) Click on **Yes**.

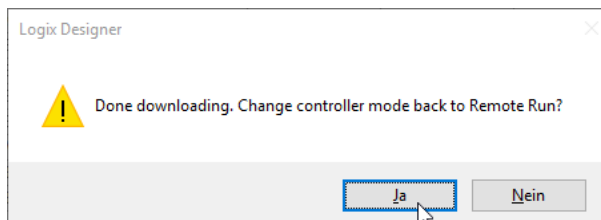

Result:

- ✓ The sensor is now incorporated into the PLC project.

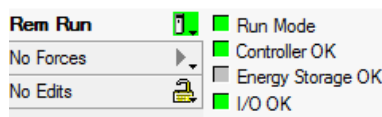

For more information about the Ethernet interface, see [EtherNet/IP](#) [▶ 23].

10.3.4 Reading/changing parameter setup via Parameter 151

Reading parameter setup

Instruction:

a) Open **MainRoutine**.

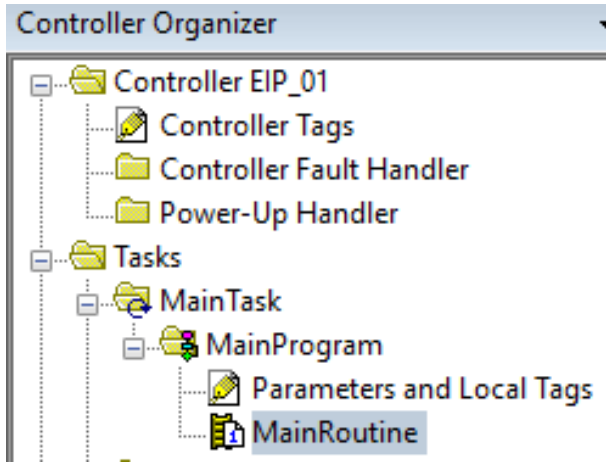

b) Under **Controller Tags** | **Edit Tags**, create the variable `Activate_Read_ConfigData` with the data type `BOOL`.



c) Under **Controller Tags** | **Edit Tags**, create the variable `ConfigData_Value_SINT` with the data type `SINT`.



d) Create the following program modules:

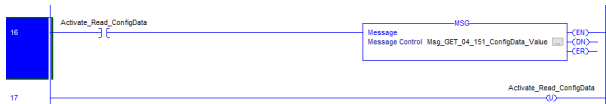

e) To fill in the content of the message, proceed as follows. In the **Destination Element** field, select `ConfigData_Value_SINT`.

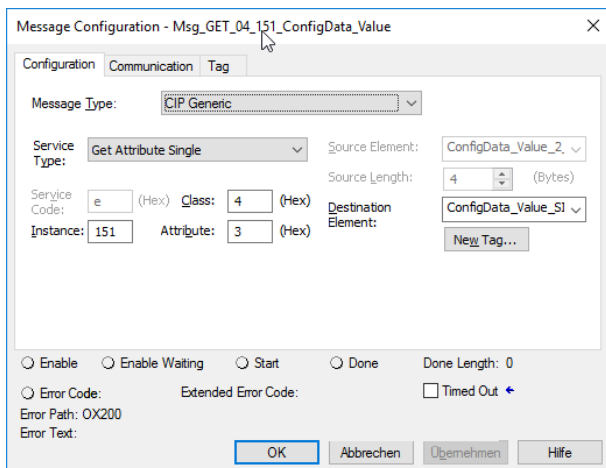

f) Go online (connection to PLC established).

g) Click on **Activate_Read_ConfigData** and then press **Ctrl + T**.

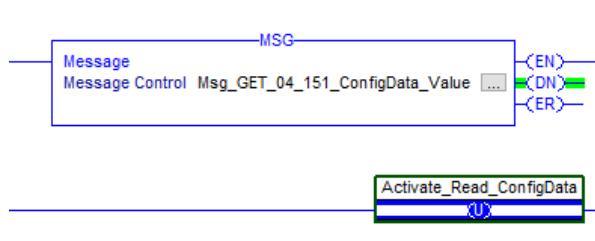

Result:

- ✓ Parameter 151 is read.
- ✓ The value of Parameter 151 is displayed under **Controller Tags**.

+ ConfigData_Value_SINT	1
-------------------------	---

Writing parameter setup

a) Open **MainRoutine**.

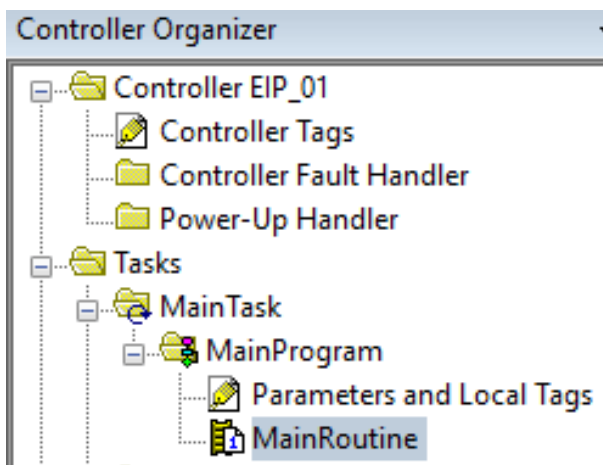

b) Under **Controller Tags | Edit Tags**, create the variable `Activate_Write_ConfigData` with data type `BOOL`.

Activate_Write_ConfigData	BOOL
---------------------------	------

c) Under **Controller Tags | Edit Tags**, create the variable `ConfigData_Value_SINT` with the data type `SINT`.

+ ConfigData_Value_SINT	SINT
-------------------------	------

d) Create the following program modules:

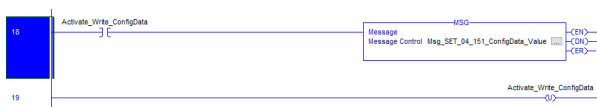

e) To fill in the content of the message, proceed as follows. In the **Source Element** field, select `ConfigData_Value_SINT`.

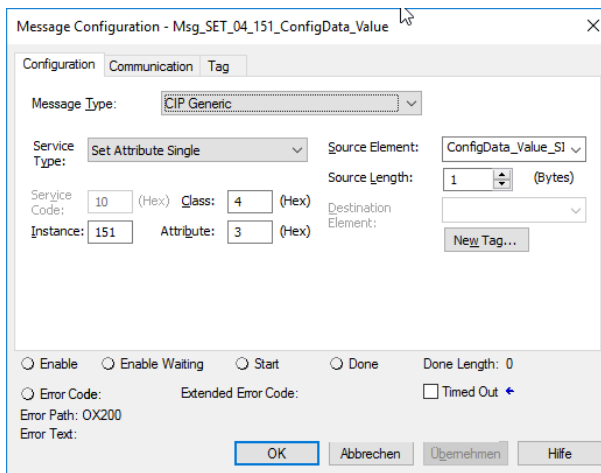

f) Go online (connection to PLC established).

g) Under **Controller Tags**, enter the desired value for Parameter 151.



h) Click on **Activate_Write_ConfigData** and then press **Ctrl + T**.

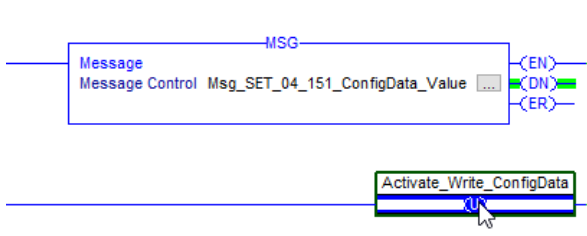

Result:

✓ Parameter 151 is written.

10.3.5 Additional information about accessing cyclic process data

Instruction:

- a) Open **MainRoutine**.
- b) Select **COP**.

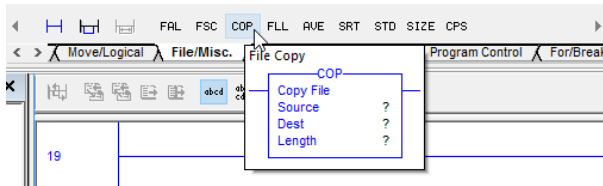

- c) Select the variable for the source (**Source**). For example, **OX200:I.Data[7]** for Measured value 1 (Input1).

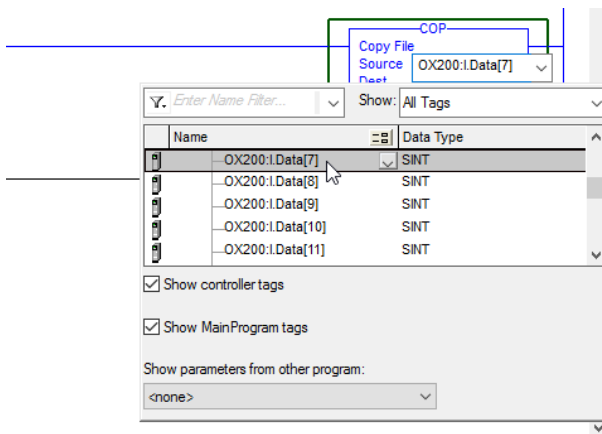

- d) Under **Controller Tags | Edit Tags**, create the variable **Input 1** with data type **REAL**.
- e) Select the variable for the destination (**Dest**).

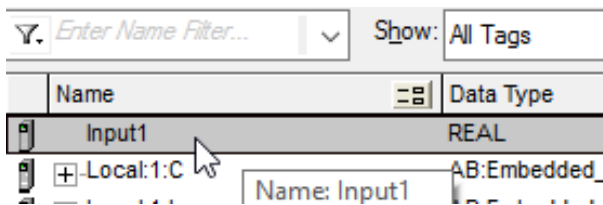

- f) Under **Length**, enter the number of bytes to be copied.

Result:

- ✓ Using the **COP instruction** specified, the bytes **OX200:I.Data[7]** to **OX200:I.Data[10]** are copied to the variable **Input 1**. On an OX200, the process data bytes 7 to 10 correspond to Measured value 1. The data type for Measured value 1 is **REAL**.

10.3.6 Additional notes about EtherNet/IP objects

Keep the following special aspects in mind when operating the sensor with EtherNet/IP.

0x1 Identity Object

The *Identity* object (0x1) supports the service *Reset Type Class 0*. It can be used to perform a *Soft Reset* via this interface. This function has the same effect as interrupting the power supply. Other reset functions are not supported by this interface. If necessary, a *Factory Reset* should be performed via the Web interface.

0xF5 TCP/IP Object

The *TCP/IP* object (0xF5) supports parameterization of IP settings (similar to the web interface). In contrast to other interfaces, a change of the IP parameters made via EtherNet/IP takes effect only after a *Soft Reset*. Bit 5 of attribute 2 signals a pending change. A reset can be performed either via the *Reset Service* (Identity Object) or by interrupting the power supply.

The destination address for multicast messages (attribute 9) is set by the standard algorithm. Manual setting and changing of the *TTL* value (Time To Live, attribute 8) is not supported for these messages.

For a complete overview of the EtherNet/IP functions and parameterization you use the EtherNet/IP tool from the ODVA member company *Molex*®.

10.4 Modbus TCP: Integrate sensor in PLC [OXM / OXS]

The Modbus TCP server (Modbus TCP slave) integrated in the sensor can be addressed using the following parameters:

- TCP port no.: 502
- Modbus TCP Unit Identifier: 1

For more information on the Modbus interface see [Modbus TCP \[p 29\]](#).

10.5 OPC UA: Add sensor in client UaExpert [OXM / OXS]



INFO

The example in this section refers to the use of the free-of-charge OPC UA client *UaExpert*. You can obtain the software following prior registration at <https://www.unified-automation.com>. Of course, the sensor can also be configured using the software of other manufacturers and their controls. The steps must then be carried out correspondingly.

To add the sensor to the OPC UA client, proceed as follows:

Instruction:

- a) Open the *UaExpert* client.
- b) In the top toolbar, click the **Add Server** button.



- c) In the **Add Server** window, open the structure underneath **Customer Discovery**.
- d) Select **<Double click to Add Server...>** by double clicking.
- e) In the **Enter URL** window, enter the IP address of the sensor.

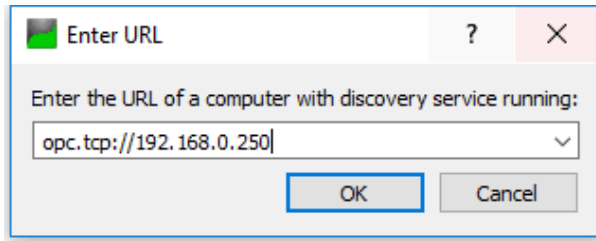

f) Confirm with **OK**.

- ✓ The sensor appears in the **Add Server** window under **Custom Discovery**.

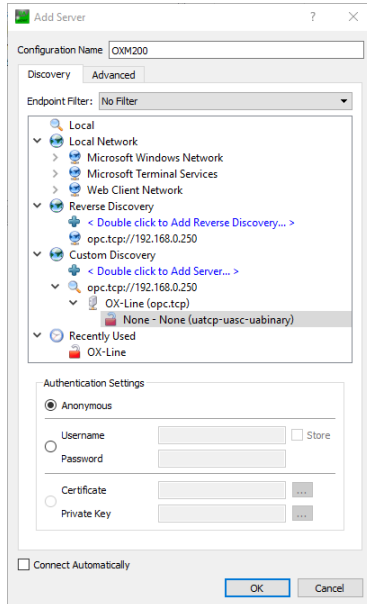

g) Confirm with **OK**.

- ✓ The sensor appears in the **Project** window under **Project | Servers**.

h) Mark the sensor in the **Project** window and select **Right click | Connect**.

Result:

- ✓ The sensor is now connected to the client.
- ✓ The function tree has been read from the sensor and is now displayed in the **Address Space** window.

For more information about OPC UA and the *UaExpert* client see [OPC UA \[▶ 33\]](#).

10.6 Set up IO-Link [OXM / OXS]

Download the IODD file for the sensor from the website www.baumer.com/OX200 or from *IODDfinder* (<https://ioddfinder.io-link.com>). You can track the matching IODD file using the sensor's product number.

The sensor requires an IO-Link master of port class B (additional power supply via pin 11 and pin 12). If the IO-Link master supplies sufficient current, the sensor can also be operated in a port class A configuration. Pin 11 must also be connected to voltage for this purpose.

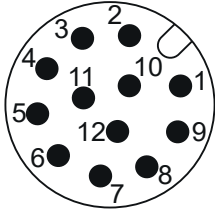

III. 27: OXM200 – Electrical connection, M12 12-pin, A-coded, male

1	Power (18 ... 30 VDC) / IO-Link P24 (2L+)	2	GND / IO-Link N24 (2M)
3	Encoder A	4	Analog Out
5	Encoder A neg.	6	OUT 1 / IO-Link C/Q
7	Encoder B	8	OUT 2
9	IN 1 (sync in)	10	Encoder B neg.
11	Power / IO-Link L+	12	GND /IO-Link L-

For more information about the IO-Link interface, see [IO-Link](#) [▶ 37].

11 Web interface

11.1 Description of the user interface

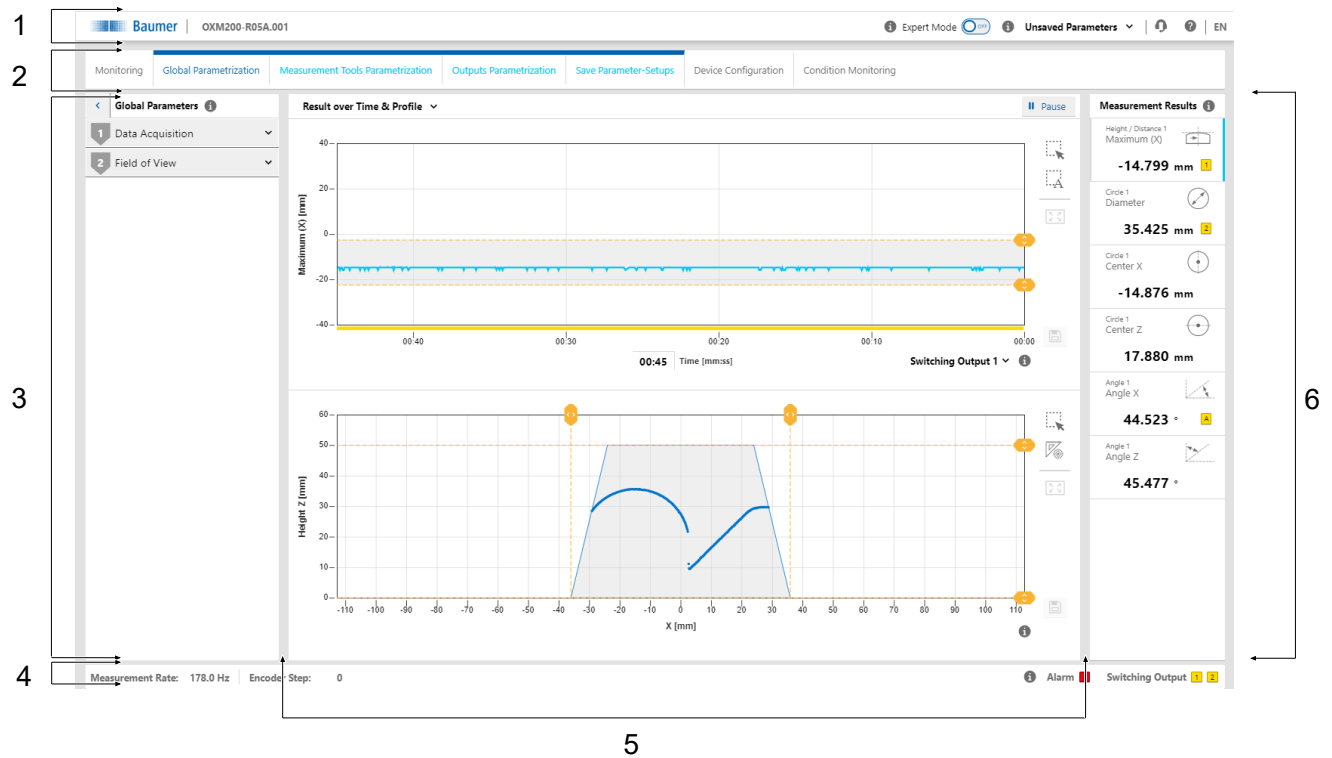



III. 28: Web interface – user interface

1	Header area	2	Menu bar
3	Parametrisation area	4	Footer area
5	Visualisation area	6	Measurement Results window

11.1.1 Header

The header is found in the top section of the user interface. The header is always visible, no matter which mode is currently applied.

<p>Example: OXM200-R05A.001</p>	<ul style="list-style-type: none"> ■ Sensor name (part number code)
<p>Expert Mode</p>	<ul style="list-style-type: none"> ■ Activation/deactivation of the expert mode. ■ In the expert mode, more complex functions and parameters become visible that require a deeper understanding of measurement physics and the applied algorithm. The expert mode can be activated and deactivated at any time.
<p></p>	<ul style="list-style-type: none"> ■ Call up the context help.
<p>Parameter Setup</p>	<ul style="list-style-type: none"> ■ Select the desired parameter setup. ■ Changes take effect immediately. However, the changes must be stored in the parameter setup to be available after a restart of the sensor.
<p>Unsaved Parameters</p>	<ul style="list-style-type: none"> ■ Message that a change has not been stored yet.
<p></p>	<ul style="list-style-type: none"> ■ Button for requesting support via e-mail. ■ Display of sensor type and serial number.

	<ul style="list-style-type: none"> ▪ Link to the Baumer website.
EN	<ul style="list-style-type: none"> ▪ Selection of the language of the user interface.

11.1.2 Menu bar

The menu bar allows the navigation among the modes of the web interface. The currently selected menu item is highlighted by a blue ribbon and blue text.

Monitoring	<ul style="list-style-type: none"> ▪ Display of measured data. ▪ No parameter change enabled.
Parametrization	<ul style="list-style-type: none"> ▪ Sensor parameterization. ▪ Access to this mode may protected by password as an option. ▪ In parameterization mode, the alarm output is set to high.
– Global Parametrization	<ul style="list-style-type: none"> ▪ Initial settings of the signal chain (particularly camera): <ul style="list-style-type: none"> ▪ Optimisation of data collection. ▪ Optimisation of the field of view.
– Measurement Tools Parametrization	<ul style="list-style-type: none"> ▪ Selection and setup of the smart functions integrated into the sensor.
– Outputs Parametrization	<ul style="list-style-type: none"> ▪ Allocation of the measured values to the switching outputs. ▪ Setting the switching windows and switching points.
– Save Parameter-Setups	<ul style="list-style-type: none"> ▪ Storage of the the set parameters as a parameter setup in the sensor (maximum 32 setups) or externally. ▪ External storage is in the .json format. The JSON file can be transferred to sensors with identical type code (measurement range and interface). ▪ The parameter setups can each be renamed separately as well as imported/exported. ▪ Alternatively, you can import/export the entire parameter setup. ▪ A single file contains all sensor parameters except the interface-relevant parameter. ▪ Interface-relevant parameters are also saved when saving the entire parameter setup block. When importing, you can select whether these are imported.
Device Configuration	<ul style="list-style-type: none"> ▪ Setting the interface-specific properties (Ethernet configuration, active process interfaces).
Condition Monitoring	<ul style="list-style-type: none"> ▪ Display of diagnostic data, such as operating time, temperature and operating voltage.

11.1.3 Window Measurement Results

The parameterized measured values appear in window **Measurement Results**. Display layout depends on the sensor-configured measurement tools. First, the window is empty but it allows for display of up to 7 measured values. Clicking one of the fields provides the assigned measured value in the visualisation area. The current selection is visualized by a blue line or by being indented. In the webinterface, the measured values come in the order they are transmitted via the process interfaces.

A	<ul style="list-style-type: none"> ▪ A yellow symbol indicates whether the measured value is assigned to one of the switching outputs or the analogue output. The colour of the symbol does not change regardless whether the switching output is active or not. ▪ See also Outputs Parametrization mode [▶ 99].
1	
2	

11.1.4 Footer

The footer is found at the bottom of the user interface. The footer is always visible, no matter of the currently applied mode.

Measurement Rate	<ul style="list-style-type: none"> ▪ Display of the current measurement rate (in Hz).
Encoder Step	<ul style="list-style-type: none"> ▪ Display of which step the encoder (if connected) is currently at. ▪ The display goes up to 65535 ($2^{16} - 1$), then the encoder step number goes back to 0.
Alarm	<ul style="list-style-type: none"> ▪ Status of the alarm output: <ul style="list-style-type: none"> ▪ Red: Alarm output is active.
Switching Output	<ul style="list-style-type: none"> ▪ Status of the switching output: <ul style="list-style-type: none"> ▪ Yellow: switching output active. ▪ Grey: switching output inactive.

11.1.5 Visualisation area

The measured data is displayed in the visualisation area. The style and structure of the visualisation area depend on the currently active mode of the web interface.

11.1.6 Parametrisation area

In the parametrisation area, depending on the selected menu item within the **Parametrization** mode, you can set various parameters (see [Mode Global Parametrization \[▶ 81\]](#), [Mode Measurement Tools Parametrization \[▶ 95\]](#), [Outputs Parametrization mode \[▶ 99\]](#) and [Mode Save Parameter-Setups \[▶ 102\]](#)).





11.2 Mode Monitoring

In **Monitoring** mode, the time curve of the measured value selected in the **Measurement Results** window (see [Window Measurement Results](#) ▶ 79) is displayed in the visualisation area. In addition, there are various setting options for the display of the measured values. The grey background and the dotted orange lines indicate the switching output window or the switching point.

In **Monitoring** mode, no parameters can be changed.



III. 29: Web interface – Monitoring mode

<p>II Pause</p>	<ul style="list-style-type: none"> Visualisation is stopped.
	<ul style="list-style-type: none"> Scaling of the measured value display by expanding the view.
	<ul style="list-style-type: none"> Automatic, dynamic scaling of the measured value display depending on the displayed data.
	<ul style="list-style-type: none"> Reset scaling.
	<ul style="list-style-type: none"> Save measured values as a CSV file.
<p>Signal</p>	<ul style="list-style-type: none"> Selection of the signal quality and the visualised switching states via a drop-down list: <ul style="list-style-type: none"> Signal quality: <ul style="list-style-type: none"> Green: valid signal Yellow: weak signal Red: no signal (no valid measured value) Switching output: <ul style="list-style-type: none"> Yellow: switching output is active Grey: switching output is inactive
<p>Time [mm:ss]</p>	<ul style="list-style-type: none"> Setting the time period in which the measured values are displayed (can be freely selected). The set time period applies to all defined measured values.

11.2.1 Saving measured data as a CSV file

The web interface offers you the option of saving the displayed measured data as a CSV file. The CSV file stores the time curve of the measured data, the status of the signal quality and the status of the switching outputs. If an encoder is connected and activated, the position of the encoder is also output.

To save the measured data as a CSV file, proceed as follows:

Instruction:

- a) In the visualisation area click the button **|| Pause**.
 - ✓ The currently displayed measured data are frozen.
- b) Click the diskette symbol in the visualisation area.
- c) The file is saved in the .csv format.

11.3 Mode Global Parametrization

In **Global Parametrization** mode, you can carry out settings at the beginning of the signal chain (especially camera).



III. 30: Web interface – Global Parametrization mode

<p>Result over Time & Profile</p>	<ul style="list-style-type: none"> ■ Selection of the view of the measured values in the visualisation area. ■ You have a choice of 5 views (for details see Changing the view ▶ 82): <ul style="list-style-type: none"> ▪ Result over Time & Profile ▪ Profile & Camera Picture ▪ Intensity & Camera Picture ▪ Profile & Intensity ▪ Profile
<p>Show Tool values</p>	<ul style="list-style-type: none"> ■ Visualisation of all set measured values.

11.3.1 Changing the view

You have a choice of 5 different views for display of the measured values in the visualisation area (in **Parametrization** mode). The views offer you the information required for parametrization of the respective situation. To change the view in the visualisation area, proceed as follows:

Instruction:

- ◆ Select the desired view in the drop-down menu on the top left of the visualisation area.

You can choose from the following views:

Result over Time & Profile

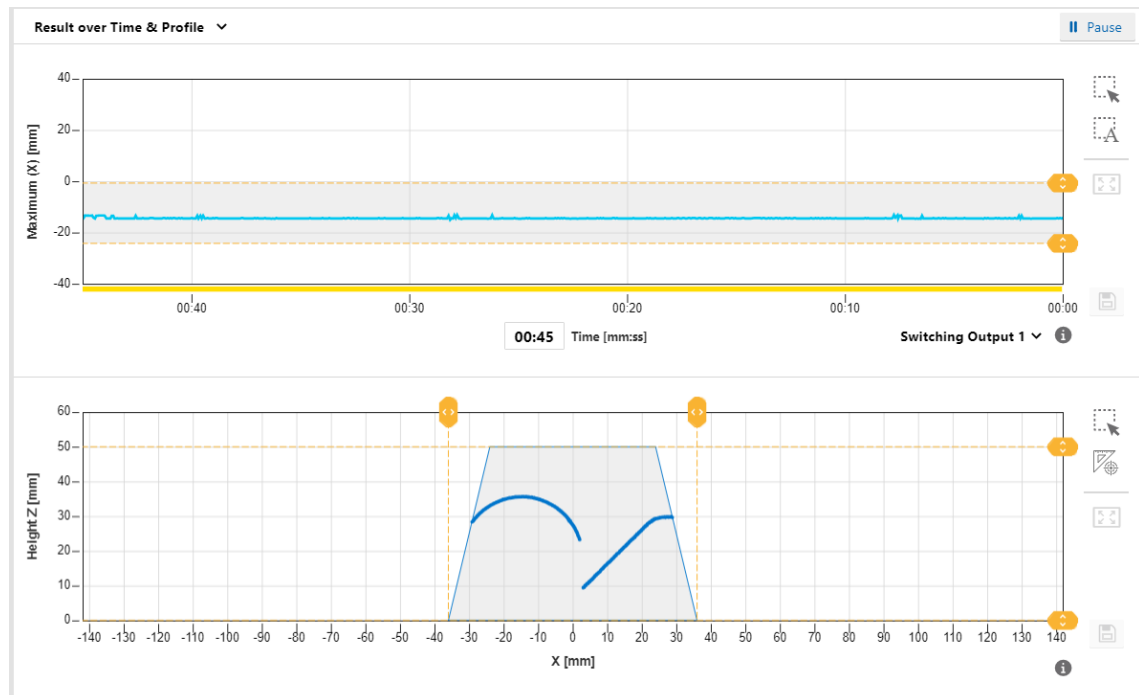

III. 31: Web interface – Parametrization mode – Result over Time & Profile view

The above diagram shows the time curve of the measured value selected in the **Measurement Results** window. The grey background and the dotted orange lines indicate the switching output window or the switching point. This diagram corresponds to the view in the **Monitoring** mode (see [Mode Monitoring \[▶ 80\]](#)).

The bottom diagram shows the profile points of the object. The field of view comes with a grey background. Saving the measured data does not include the profile points (x-z). You can narrow down the measurement field by drag & drop and the yellow lines. The change is immediately adopted. As soon as the measurement field has been narrowed down, any area outside the measurement field is no longer available for further processing.

Optionally, the displayed profile can be saved as a CSV file via the web interface. The CSV file stores the profile points (x-z) in mm units and a timestamp from the host. For doing so proceed as follows:

- In the visualisation area click the button **Pause**.
 - ✓ The currently displayed measured data are frozen.
- Click the diskette symbol in the visualisation area to the right of the profile graph.
- The file is saved in the .csv format.

Profile & Camera Picture

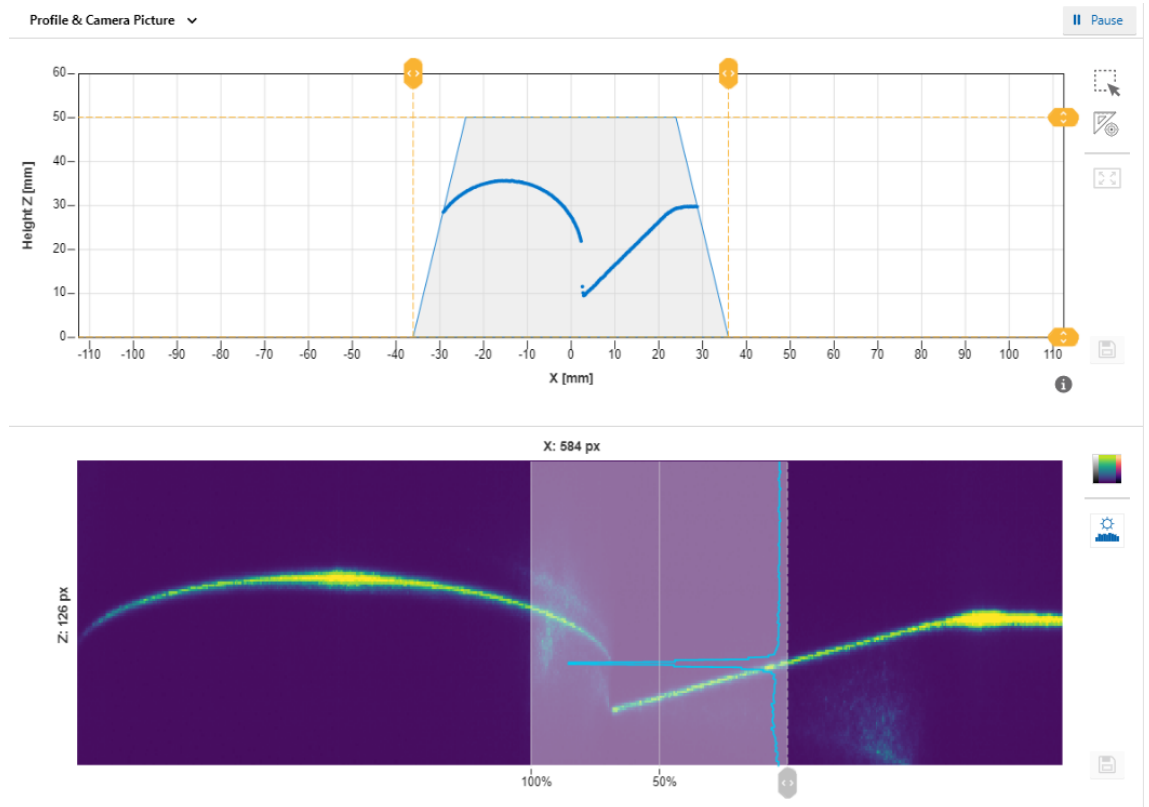

III. 32: Web interface – Parametrisation mode – Profile & Camera Picture view

The top diagram shows the profile points of the object. This diagram corresponds to the bottom diagram in the **Result over Time & Profile** view.

The bottom diagram shows the camera image. This allows the detection of unwanted reflections, for example. The image can be presented in false colours via the top button to the right of the camera image. This can help you set the correct exposure time or find unwanted reflections. The lower button can be used to show an overlay indicating a cut along a select camera column. The overlay indicates the intensity of the column. The active column can be freely selected by the grey slider underneath the camera image.

Intensity & Camera Picture

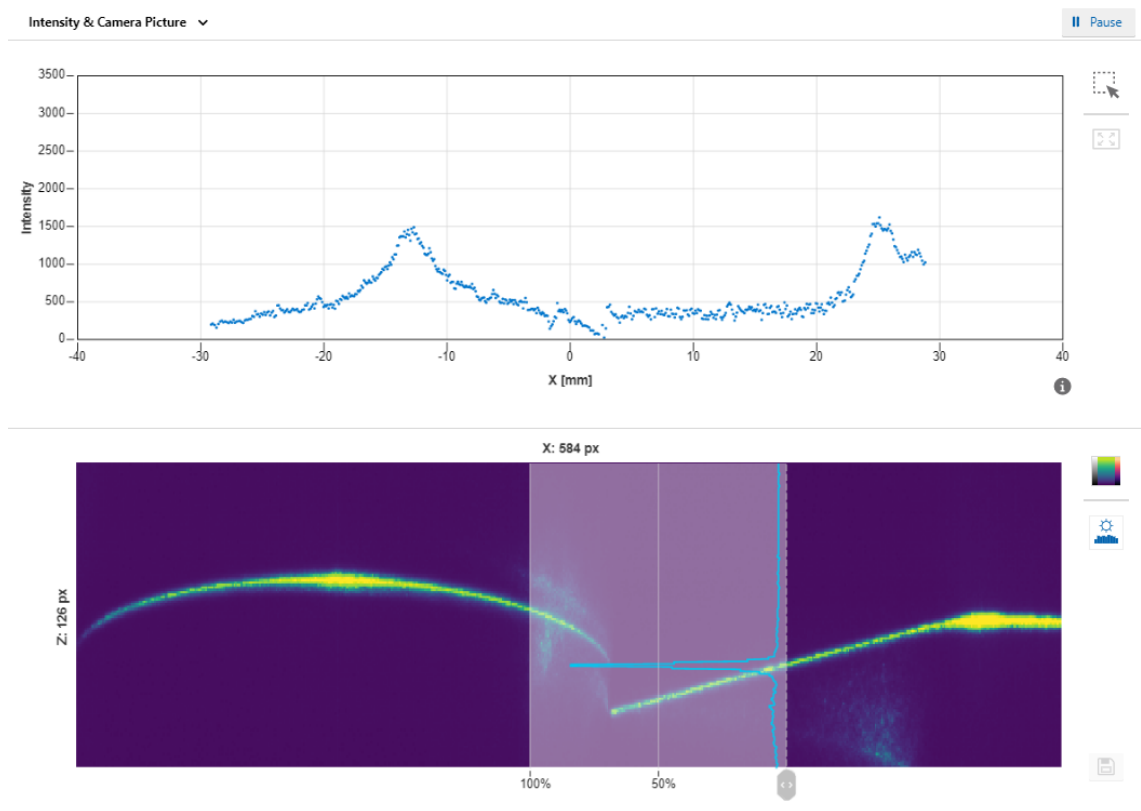

III. 33: Web interface – Parametrisation mode – Intensity & Camera Picture view

The top diagram is a measure of the intensity of the pixels along a column. This view allows you to recognise artefacts in the profile graph and to trace them back to the structure of the surface.

The bottom diagram shows the camera image. This diagram corresponds to the bottom diagram in the **Profile & Camera Picture** view.

The web interface offers the option of saving the displayed profile as a PNG file containing the unprocessed camera image. For this process, proceed as follows:

- a) In the visualisation area click the button **II Pause**.
 - ✓ The currently displayed measured data are frozen.
- b) Click the diskette symbol in the visualisation area to the right of the camera image.
- c) The file is saved in the .png format.

Profile & Intensity

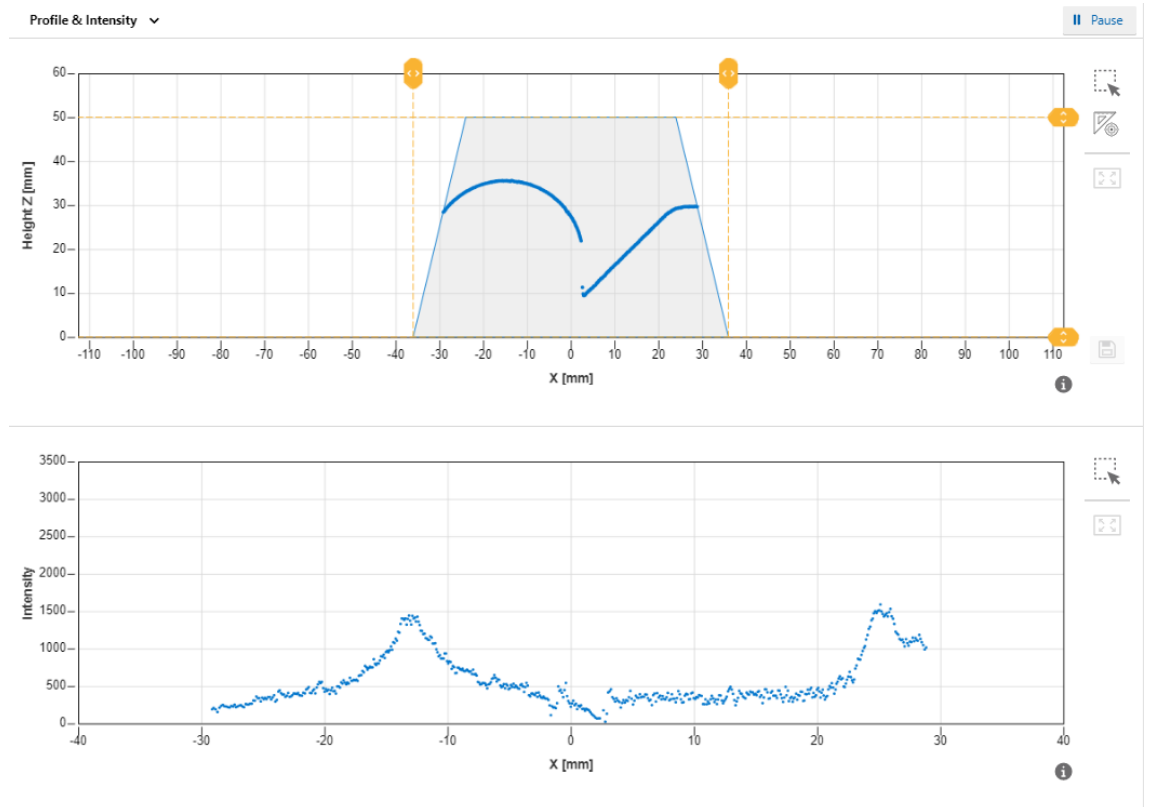

III. 34: Web interface – Parametrisation mode – Profile & Intensity view

The top diagram shows the profile points of the object. This diagram corresponds to the bottom diagram in the **Result over Time & Profile** view.

The bottom diagram shows the summarised pixel values along a column. This diagram corresponds to the top diagram in the **Intensity & Camera Picture** view.

Profile

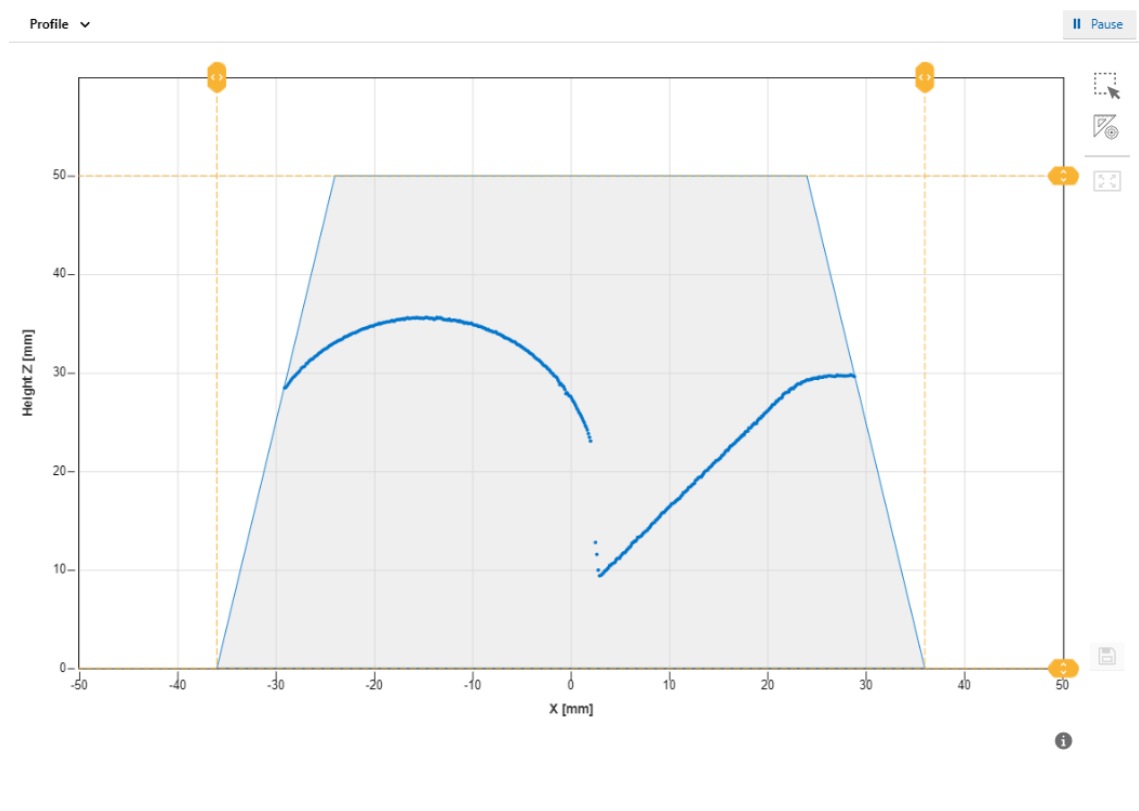

III. 35: Web interface – Parametrisation mode – Profile view

The diagram in this view shows the profile points of the object. This diagram corresponds to the bottom diagram in the **Result over Time & Profile** view.

11.3.2 Adjusting the internal resolution

Adjusting the internal resolution allows you to adjust the number of pixels transferred by the camera. While this affects the measurement rate positively, it lowers the resolution and must therefore be adjusted individually to the application. For this process, proceed as follows:

Condition:

⇒ The **Expert Mode** is activated (see [Header \[▶ 77\]](#)).

Instruction:

- Select mode **Parametrization | Global Parametrization** in the menu.
- In the **Global Parameters** window, proceed to **Data Acquisition | Internal Resolution**.
- In the drop-down list next to **Number of points in x**, select the desired number of points along the X axis that should be read out by the camera of the sensor.
- In the drop-down list next to **Binning in z**, select whether points along the Z axis should be read out by the camera as a summary and as a combined point.

11.3.3 Optimising the exposure time

The colour and surface of the object influence the amount of reflected light. Dark objects require a longer exposure time than bright objects to obtain the same signal strength. The sensor offers the **Optimize** function for a one-time automatic adjustment of the exposure time. With this function, the sensor determines the optimal exposure time based on the light quantity reflected back from the object. The adjustment involves the entire visible camera image. A reduction of the measuring rate can occur with long exposure times.

To initiate the automatic adjustment of the exposure time, proceed as follows:

Instruction:

- a) Select mode **Parametrization | Global Parametrization** in the menu.
- b) In the **Global Parameters** window, proceed to **Data Acquisition | Exposure Time**.
- c) Place the object to be measured in the field of view of the sensor.
- d) Click the **Optimize** button.

Result:

- ✓ The sensor automatically adjusts the exposure time (once).



INFO

In **Expert Mode**, you have the additional option of manually adjusting the exposure time in the entire area.

11.3.4 Adjusting the laser power

NOTICE

Decreased service life due to high laser power setting.

The permanent use of a higher laser power setting (level 2 and up) decreases the service life of the sensor.

- a) Keep the laser power at level 1, especially at constantly high ambient temperatures.

With highly reflective, very light or very dark objects, it may be necessary to adjust the laser power. Only change the laser power if you cannot sufficiently adjust the intensity by optimising the exposure time ([Optimising the exposure time \[▶ 87\]](#)). The general rule is:

- Very light objects: low laser power
- Very dark objects: high laser power

To adjust the laser power, proceed as follows:

Condition:

- ⇒ The **Expert Mode** is activated (see [Header \[▶ 77\]](#)).

Instruction:

- a) Select mode **Parametrization | Global Parametrization** in the menu.
- b) In the **Global Parameters** window, proceed to **Data Acquisition | Laser Power Selection**.
- c) In the drop-down list next to **Laser Power Level**, select the desired level of the laser power.

Also see about this

- [Optimising the exposure time \[▶ 87\]](#)
- [Header \[▶ 77\]](#)

11.3.5 Calculating the surface profile

Setting the parameters of the algorithm

The web interface offers you the option of adjusting the parameters of the algorithm that is used to calculate the profile graph. The parameters define how the algorithm extracts the profile point from the camera image. The camera image contains several pixels with varying intensity. The algorithm calculates a single value (the focal point) from several pixels found in the camera image. The algorithm uses several parameters to assess which pixels to use and which pixels to ignore.

To set the parameters of the algorithm, proceed as follows:

Condition:

⇒ The **Expert Mode** is activated (see [Header \[▶ 77\]](#)).

Instruction:

- a) Select mode **Parametrization | Global Parametrization** in the menu.
- b) In the **Global Parameters** window, proceed to **Data Acquisition | Profile Computation**.
- c) In the drop-down list next to **Algorithm**, select the desired basic type, which can help accomplish more stable results, especially in case of reflections.

The following basic types are available:

- **Standard:**
In the **Standard** setting with several peaks along a column, the peak with the greatest intensity is always used.
- **Upper CoG:**
In the **Upper CoG** setting with several peaks along a column, the top peak is always used.
- **Lower CoG:**
In the **Lower CoG** setting with several peaks along a column, the bottom peak is always used.

Setting the parameters for accumulating adjacent pixels

Within the above-stated basic types, you can carry out detailed adjustments with the help of the following parameters. These parameters determine whether adjacent pixels are accumulated as a common peak:

- **Min. Peak Height:**
 - Minimum height of a peak to be detected in relative units.
- **Min. Peak Width:**
 - Number of adjacent pixels that must be above the **Pixel Threshold** value.
- **Pixel Threshold:**
Threshold below which the pixels are ignored. The value is given in %. Depending on your choice, this is either a percentage of the maximum possible signal (255) or, as a function of the contrast of the peaks, relative to the background.

Smoothing the profile/filters

With profile smoothing, profile points are averaged with the respective adjacent profile points. This can reduce spatial noise, which can be caused, for example, by the structure of the surface or by speckle patterns. You can set the profile smoothing within the **Profile Computation** area via **Filter**.

11.3.6 Set Trigger Mode

By setting the **Trigger Mode**, you can determine the intervals at which the sensor records the measured values.

To set the trigger mode, proceed as follows:

Instruction:

- a) Select mode **Parametrization | Global Parametrization** in the menu.
- b) In the **Global Parameters** window, proceed to **Data Acquisition | Trigger Mode**.
- c) Set the desired trigger mode.

The following trigger modes are available:

- **Free Running:**

The sensor measures constantly at the highest possible frequency (which varies according to the application).

 - If the external trigger signal is used and the input is at low level, the free-running mode runs.
 - If the external trigger signal is used and the input is at high level, the measurement is paused.
 - If the external trigger signal is **not** used, the free-running mode runs continuously.
- **Interval:**

Measuring cycle with a fixed internal interval (μs). Use the **Interval** mode for measurement with a precisely defined time interval. The achievable measurement frequencies are theoretically identical to the **Free Running** trigger mode. The sensor attempts to constantly comply with the set interval. However, if the sensor is handling an earlier measurement, the measurement cannot start at the set interval. The sensor then waits until the next defined interval point is reached. This means that the measurements are always taken at a multiple of the set interval.

 - If the external trigger signal is used and the input is at low level, the Interval mode runs.
 - If the external trigger signal is used and the input is at high level, the measurement is paused.
 - If the external trigger signal is **not** used, the Interval mode runs continuously.
- **Single Shot:**

The sensor records exactly one measured value as soon as it is triggered by an external pulse. The input only detects falling edges (transition from high level to low level). As soon as the input is at high level, all output functions are frozen in their last status until the next measurement. For the specification of input *IN 1 (sync in)*, please see the data sheet that is available for download at www.baumer.com/OX200.
- **Encoder:**

Use the encoder input for synchronization with an external movement, such as a conveyor belt.



INFO

Mode **Single Shot** requires the sensor being connected to an external trigger signal during the measuring operation.

Also see about this

- 📖 [External triggering \[▶ 48\]](#)

11.3.7 Aligning the sensor (height and distance mode)

With the **Sensor Orientation** function, you can set the mode of the sensor (height or distance mode). When changing the mode, you alter the coordination system of the sensor.

To align the sensor, proceed as follows:

Condition:

⇒ The **Expert Mode** is activated (see [Header \[▶ 77\]](#)).

Instruction:

- Select mode **Parametrization | Global Parametrization** in the menu.
- In the **Global Parameters** window, proceed to **Field of View | Sensor Orientation**.
- Set the desired alignment.

You have a choice of the following modes:

- Height:**

In height mode (object space), the zero point of the Z axis is located in the reference surface away from the sensor (RP_H). The positive direction of the Z axis is pointing to the sensor.
- Distance:**

In distance mode (sensor space), the zero point of the Z-axis is at the front of the sensor (RP_D). The positive direction of the Z-axis is pointing away from the sensor.

11.3.8 Mounting Assistant



INFO

Baumer recommends mounting the sensor at a right angle towards the reference surface of the object to be measured. The **Mounting Assistant** function of the web interface will support you in doing so. If 90° mounting is not possible, the **Flex Mount** function will compensate mounting angles up to $\pm 30^\circ$.

The **Mounting Assistant** function provides you with the tilt angle and the distance to the reference surface R detected in the field of view (see the following figure).

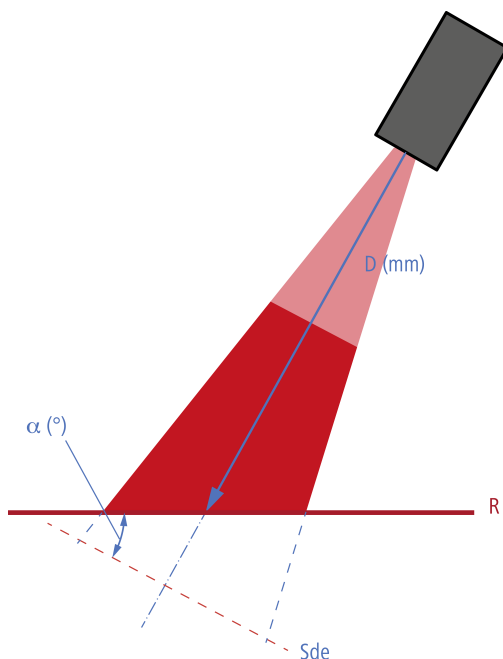

III. 36: Inclination angle and distance to the reference surface

To position the sensor, proceed as follows:

Instruction:

- a) Select mode **Parametrization** | **Global Parametrization** in the menu.
- b) In the **Global Parameters** window, proceed to **Field of View** | **Mounting Assistant**.
- c) Position the sensor.

11.3.9 Flex Mount: Compensating mounting angles



INFO

Function **Flex Mount** is exclusively available in height mode.

With the **Flex Mount** function, you can compensate mounting angles up to $\pm 30^\circ$. This is required if 90° mounting between the sensor and the reference surface is not possible or the background of the measurement object is to be masked. The tilt angle and distance to the reference surface are automatically measured and stored in the sensor. This enables correct rotation of the coordinate system by the software. The profile of the measurement object is determined in line with normal alignment of the sensor to the reference surface (90°).

With angled mounting, the reference point (RP) of the K axis shifts from the centre of the measurement field or the red visible laser line. By angling the sensor, the two sections of the measurement field (measurement field width left (area A) and measurement field width right (area B)) are no longer the same size.

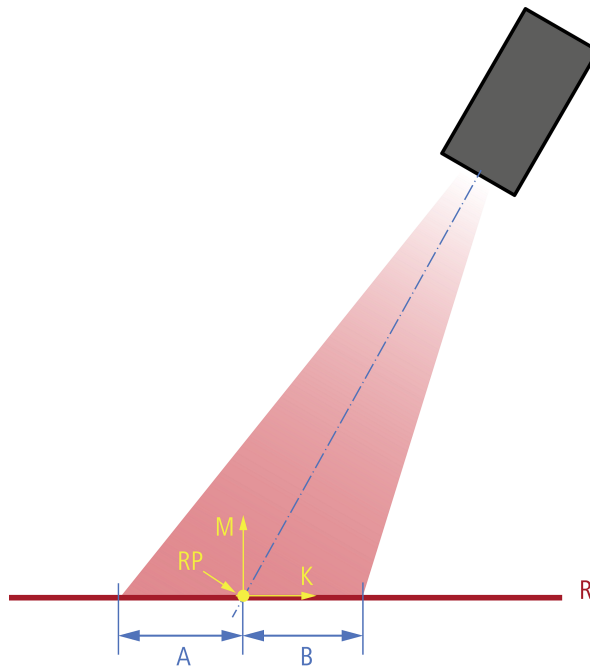

III. 37: Reference point for angled installation

For the teach-in process, make sure that the reference surface is even and that the maximum possible measurement range of the sensor is covered. The detected line must have a minimum length (50 % relative to the field of view width) and must not exceed a maximum roughness. Manual input and compensation are always possible. This function is recommended if the sensor is not aligned normally to the reference surface, e.g., oriented to the base area of the measurement object.

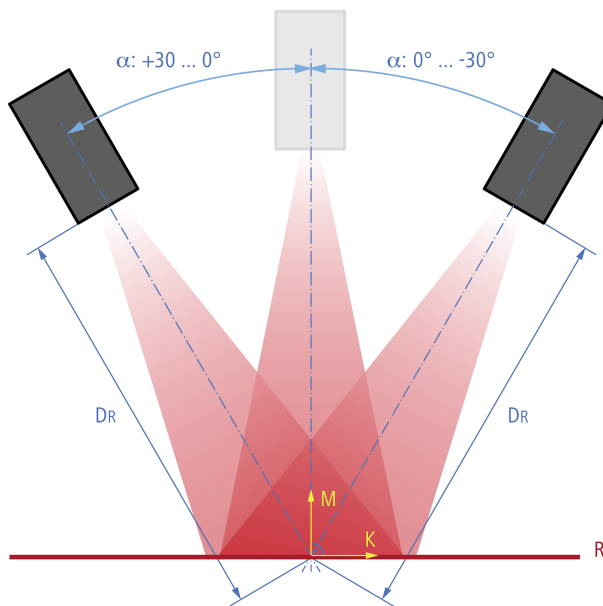

III. 38: Inclination angle and distance to the reference surface with angled installation

To activate the **Flex Mount** function, proceed as follows:

Condition:

- ⇒ The reference surface is within the measurement range (distance between the sensor and the reference surface is less than the measurement range end S_{de}).
 - ⇒ The maximum tilt angle is $\pm 30^\circ$.
 - ⇒ For uneven reference surfaces: The unevenness must not exceed a maximum value, which depends on the measurement range and the exposure. If required, use an auxiliary plate during teaching in or alternatively adjust the parameters manually.
 - ⇒ There are no undesired objects in the measurement field.
- a) Select mode **Parametrization** | **Global Parametrization** in the menu.
 - b) In the **Global Parameters** window, proceed to **Field of View** | **Flex Mount**.
 - c) Set **Flex Mount** to **On**.
 - d) Click the **Auto** button.
 - e) Confirm with **Teach Flex Mount**.

Result:

- ✓ The coordinate system is rotated.
- ✓ The reference surface is taught in. The original reference point of the sensor is no longer valid.
- ✓ Measurement objects below the reference surface are ignored.
- ✓ The axes are no longer referred to as X and Z axes, but as K and M axes. The denomination does not change on the web interface.
- ✓ The measurement field is reset to the maximum measurement field.

Using an auxiliary plate

To compensate any irregularities in the reference surface you may use an auxiliary plate for the teach-in process. The auxiliary plate should be as even as possible and provide the minimum length of the reference surface $L_{R, \min}$. According to the sensor's sensing range, $L_{R, \min}$ is at approx. 50 % of the field of view depth at the reference distance. Conditions are the same as for teaching of **Flex Mount**. Make sure that the auxiliary plate is parallel to the reference surface

underneath. As long as being within the sensor's measurement field, the thickness of the auxiliary plate can be selected at will. In the next step, the thickness may be deducted via the web interface.

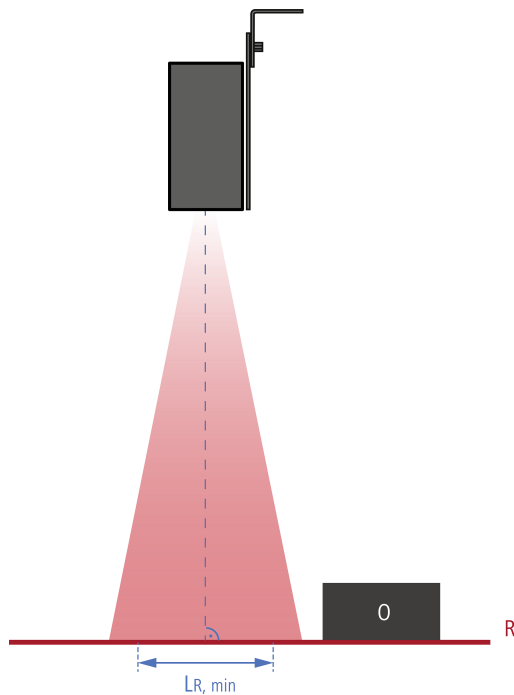

III. 39: Minimum length of the the reference surface $L_{R, min}$

11.3.10 Flex Mount: Moving the reference surface

Moving the reference surface after teaching in is necessary if you want to deduct the thickness of the auxiliary plate used during teaching in, for example.

Example: When using the **Delta Height** function within **Parametrization | Measurement Tools**, the taught-in reference surface impairs the measurement result.

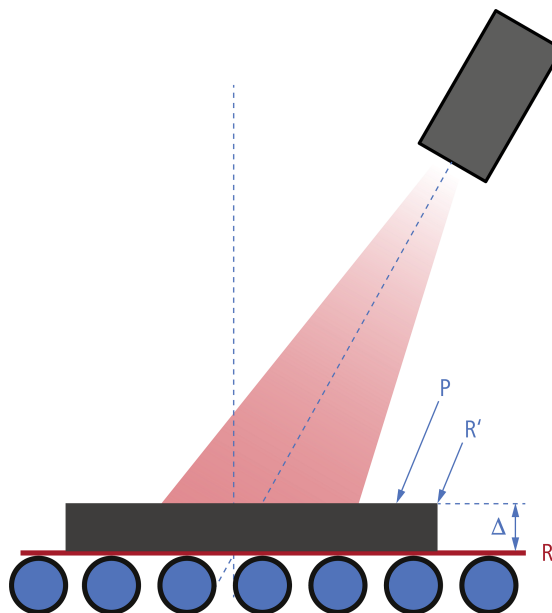

III. 40: Flex Mount: Moving the reference surface

To move the reference surface, proceed as follows:

Instruction:

- a) Select mode **Parametrization** | **Global Parametrization** in the menu.
- b) In the **Global Parameters** window, proceed to **Field of View** | **Flex Mount**.
- c) Set **Flex Mount** to **On**.
- d) Click the **Auto** button.
- e) In the **Reference** field, enter the value by which the reference surface should be moved (e.g. -5).

Result:

- ✓ The reference surface is placed over the originally taught-in reference surface (of the auxiliary plate), so that it is masked and no longer affects the measurement result.

**INFO**

If the reference surface should not be moved, the value in the **Reference** field must be 0 mm. As soon as the **Flex Mount** function is activated, the current measurement field is reset to the maximum measurement field.

11.3.11**Resetting Flex Mount**

Resetting the **Flex Mount** sets the **angle** to 0° and the **distance** to the *measurement range end Sde*. As soon as the function is reset, the measurement field is equal to the maximum field of view.

To reset **Flex Mount**, proceed as follows:

Instruction:

- a) Select mode **Parametrization** | **Global Parametrization** in the menu.
- b) In the **Global Parameters** window, proceed to **Field of View** | **Flex Mount**.
- c) Click the **Reset** button.

11.3.12**Setting the limits of the field of view**

You can use the **Field of View Limits** function to set that only part of the camera is read out, thus reducing the field of view (FoV). The profile points outside the set field of view limit are ignored. The function does not affect the width of the laser line.

With the **Set FOV to Max** selection, you reset all limits of the field of view back to the standard settings (maximum measurement field).

**INFO**

As soon as you use the **Flex Mount** function to teach in a new reference surface, the field of view is maximised.

The **Field of View Limits** function is only recommended if you want to optimise the measurement rate of the sensor. The **Region of Interest Limits** function in the **Measurement Tools Parametrization** mode is available for masking disruptive reflexes or undesired objects. You can set individual evaluation range limits for each stored measurement tool.

11.4 Mode Measurement Tools Parametrization

In **Measurement Tools Parametrization** mode you can allocate measurement tools to the sensor and set the properties of the individual measurement tools. A measurement tool is a function that is predefined in the sensor and which can be used to generate measured values such as height, width or angle, based on the profile data.



III. 41: Web interface – Measurement Tools Parametrization mode

The order of the measurement tools in the **Measurement Tools** window corresponds to the order of the selected measured value in the measured value array. Click the 3 dashes of the respective measurement tool to change its position or name or to delete the measurement tool. The measuring tool order in the web interface defines the order of the measured values in the protocol.

Measurement tool vs. auxiliary tool

Measurement tools use the profile as input. Auxiliary tools use the output of a measurement tool as input. For an auxiliary tool, the input must be defined before a measured value can be displayed. If the input has not been defined or if a measured value at the input is invalid, NaN (Not a Number) is output. Due to the fact that the measuring tools and the auxiliary tools can also display negative numbers, a number is not possible as error code.

ROI (Region of Interest)

ROI (Region of Interest) is the region where the profile points are included in the evaluation (shown in green on the web interface). You can freely select the ROI (on the web interface with the help of the sliders or the input fields).

Blind region

Blind regions (shown in grey on the web interface) are the regions outside the ROI. Profile points and measured values inside the blind region are ignored in the evaluation. You can freely select the blind regions (on the web interface with the help of the sliders or the input fields).

11.4.1 Setting the position tracking (ROI tracking)

With position tracking (ROI tracking), a measurement can be carried out in a specific region of an object relative to another distinctive feature (e.g. an edge). This way, variations of the object position along the laser line can be compensated.

You can select any measurement point resulting from a previously defined measurement tool as coupling source. For example, the calculation of a mean value can be coupled to the position of an edge. If the position of the edge changes, the position of the ROI is dynamically tracked.

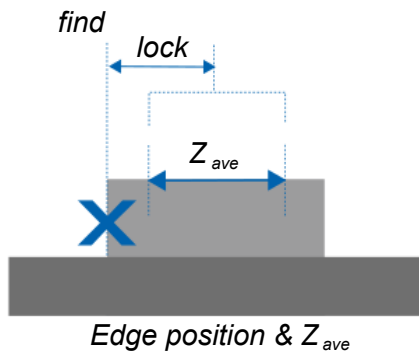

III. 42: Position tracking (ROI tracking)

To set the position tracking, proceed as follows:

Instruction:

- a) Select mode **Parametrization | Measurement Tools Parametrization** in the menu.
- b) Create a measuring tool for a characteristic that you want to use as a reference characteristic.
- c) Create a measuring tool for whose position you want to track the measurement.
- d) In the **Measurement Tools** window, go to the desired measurement tool and select **Couple ROI to**.
- e) Open the **Select Tracking Source** drop-down list and select the desired coupling source (as defined in step b).

11.4.2 Setting the background tracking



INFO

Background tracking requires the measuring tool straight/angle. Please refer to the sensor data sheet whether this tool is supported.

With background tracking, you perform a measurement relative to a defined background line. This compensates for fluctuations of the background angle or background height.

You can select a line defined previously in a line / angle measuring tool as the background source. If the position of the background line changes, the position of the ROI is tracked dynamically.

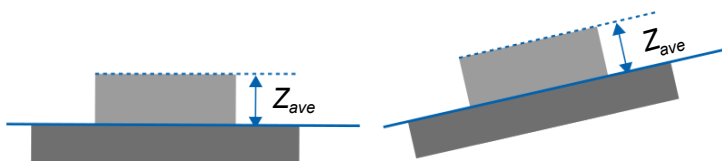

III. 43: Background tracking

To set background tracking, proceed as follows:

Instruction:

- a) Select mode **Parametrization | Measurement Tools Parametrization** in the menu.
- b) Create a line / angle measuring tool and select the range that best resembles the background. If necessary, regions can be excluded by using the blind range function.
- c) Create a measuring tool for which you wish to track the background.
- d) In the **Measurement Tools** window, go to the desired measurement tool and select **Couple Background to**.
- e) Open the **Select Tracking Source** drop-down list and select the desired coupling source (as defined in step b).

11.4.3 Temporal Filter setting

With the **Temporal Filter** function, the noise can be reduced and thus the resolution and repeatability increased. The response and drop-off times are increased and moving objects detected less precisely as a result. The precision filter calculates the results in the form of floating values. The oldest measured value is removed as soon as a new measurement is added. Therefore the measuring frequency is not affected by the precision filter.

To set the **Temporal Filter** function, proceed as follows:

Instruction:

- a) Select mode **Parametrization | Measurement Tools Parametrization** in the menu.
- b) In the **Measurement Tools** window, go to the desired measurement tool and select **Temporal Filter**.
- c) Set the **Temporal Filter** function.

You can set the following filters:

- **Average:**
This filter calculates the average value of an array. You can set the length of the filter.
- **Median:**
This filter calculates the median via a configurable number of measured values that are in a time sequence (sample). The median is defined as the value below which 50 % of the measured values in the sample are located. The median filter can be used to suppress individual outliers. With greater filter lengths, the filter can also suppress several successive outliers.

Example: Calculating the response time with a measurement frequency of 500 Hz

- **Formula:**
 - Response time = $1 / \text{measurement frequency} \times (\text{median} + \text{average})$
- **Sample values:**
 - Measurement frequency: 500 Hz
 - Median = 4
 - Average = 16
- **Calculation:**
 - Response time = $1/500 \text{ Hz} \times (4 + 16) = 0.04 \text{ s} = 40 \text{ ms}$

11.4.4 Processing an invalid measured value

The **Invalid Value Handling** function allows for defining the output holding time of a measured value in the event it is followed by invalid measured values. This way, sudden but expected signal interruptions are compensated. Each measuring tool can be set independently.

To configure the processing of invalid measured values, proceed as follows:

Instruction:

- a) Select mode **Parametrization | Measurement Tools Parametrization** in the menu.
- b) In the **Measurement Tools** window, go to the desired measurement tool and select **Invalid Value Handling**.
- c) Enter the desired holding time for the invalid measured value.

11.5 Outputs Parametrization mode

In **Outputs Parametrization** mode, you can allocate the corresponding measurement tools to the sensor outputs.

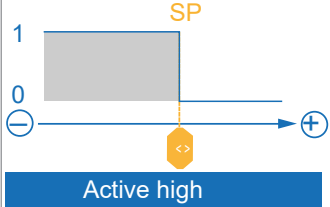
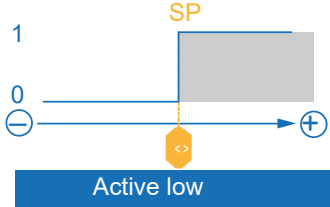
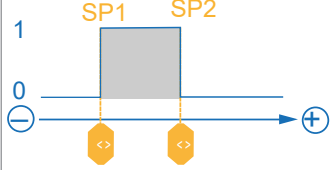
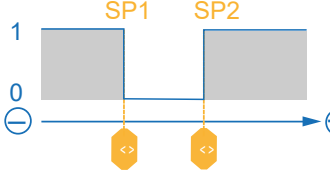
Digital Output 1 / 2	
– Switching Output	<ul style="list-style-type: none"> ■ Each active measured value or the alarm can be assigned to one of the switching outputs. ■ Select whether the switching output is in point mode (switching point P1) or in window mode (switching point P1 and switching point P2). ■ The behaviour in case of invalid measured values is set separately for the measured value. ■ See also Processing an invalid measured value [98]. ■ The alarm output is output as a push-pull signal (Active High) if it has been assigned to one of the switching outputs. ■ The alarm output is active when <ul style="list-style-type: none"> ▪ the profile quality is poor, ▪ the sensor is in the parametrisation mode.
– Hysteresis	<ul style="list-style-type: none"> ■ Hysteresis input. ■ See also Setting the hysteresis [100].
– Polarity	<ul style="list-style-type: none"> ■ Selection Active High / Active Low. ■ Polarity is for setting the switching outputs behavior relative to the output level. On the web interface the region where the switching outputs are set to high is shown in grey. <div style="display: flex; justify-content: space-around; align-items: flex-start; margin-top: 10px;"> <div style="text-align: center;">  <p>Active high</p> </div> <div style="text-align: center;">  <p>Active low</p> </div> </div> <div style="display: flex; justify-content: space-around; align-items: flex-start; margin-top: 10px;"> <div style="text-align: center;">  </div> <div style="text-align: center;">  </div> </div>
Analog Output	<ul style="list-style-type: none"> ■ Each active measured value can be applied to the analogue output. ■ You can define the behaviour of the Analog Output for cases where the measured value applied to the Analog Output is not valid (NaN). The following scenarios are possible: <ul style="list-style-type: none"> ▪ The Analog Output jumps to the minimum or maximum value of the available analogue region, or ▪ the last valid measured value is permanently applied to the Analog Output. ■ Different types (voltage and current) and regions can be selected for the Analog Output. The minimum/maximum output points refer to the measured values of the analogue output that are scaled to the minimum/maximum region of the analogue output. If required, the gradient of the analogue output can also be inverted.

11.5.1 Setting the hysteresis

The hysteresis is the difference between the switching-on and switching-off threshold in mm. Without hysteresis (H), objects near the switching point can lead to a repeated switching of the switching output. It is recommended to use a hysteresis with a value at least as high as the resolution of the sensor. You can enter the hysteresis as a positive or negative value. The minimum value of the hysteresis depends on whether the hysteresis is positive or negative. In both cases, the minimum value is selected so that the distance between the switching points equals zero.

Negative hysteresis

The hysteresis is situated between the switching points (window mode) or points towards lower measured values (point mode). With a negative hysteresis, the minimum distance of the switching points is equal to the value of the hysteresis times two.

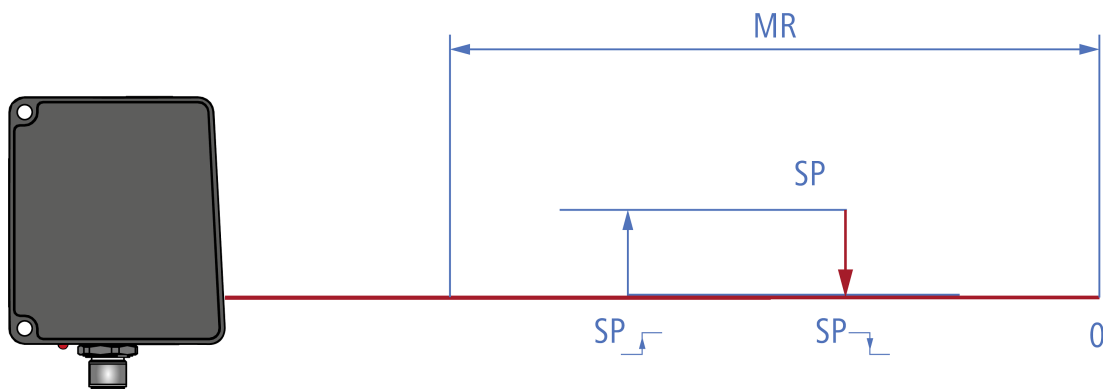

III. 44: Negative hysteresis

Positive hysteresis

The hysteresis is situated outside the switching points (window mode) or points towards larger measured values (point mode). With a positive hysteresis, the minimum distance of the switching points is 0.

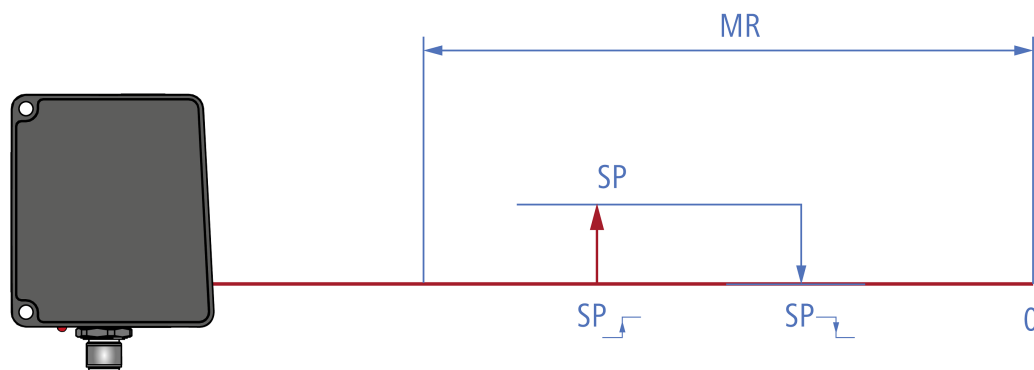

III. 45: Positive hysteresis

Behaviour of the switching output in point mode

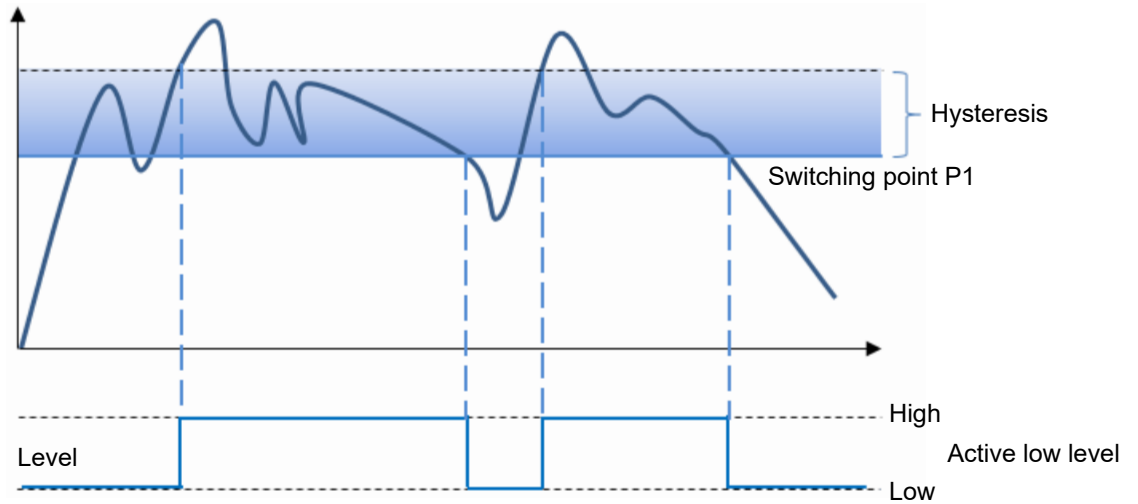

III. 46: Behaviour of the switching output in point mode (positive hysteresis)

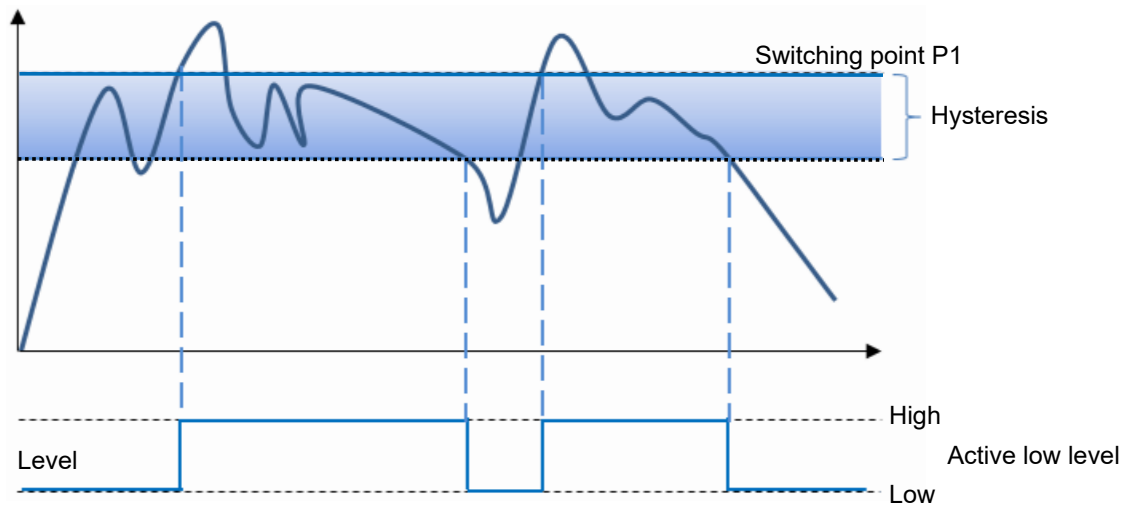

III. 47: Behaviour of the switching output in point mode (negative hysteresis)

Behaviour of the switching output in window mode

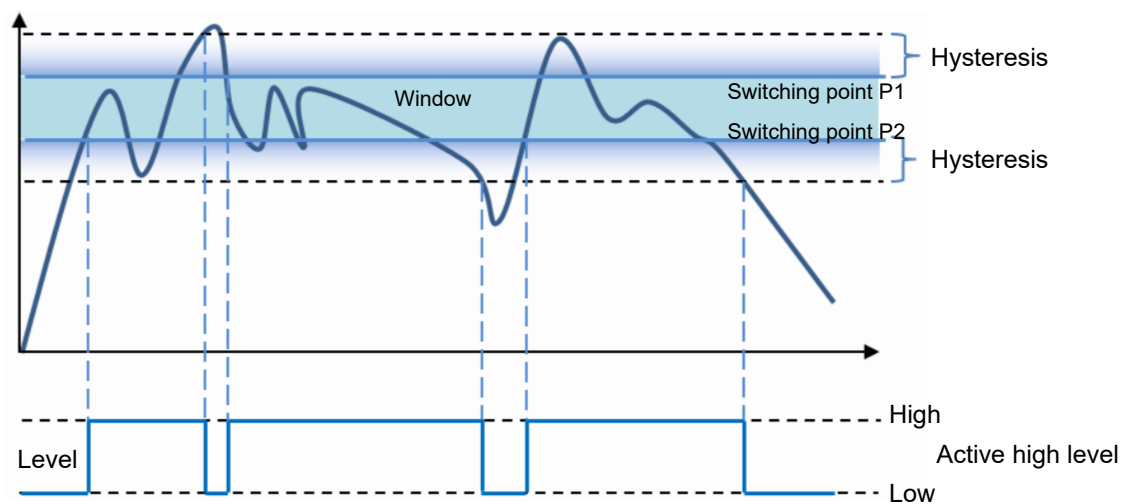

III. 48: Behaviour of the switching output in window mode (positive hysteresis)

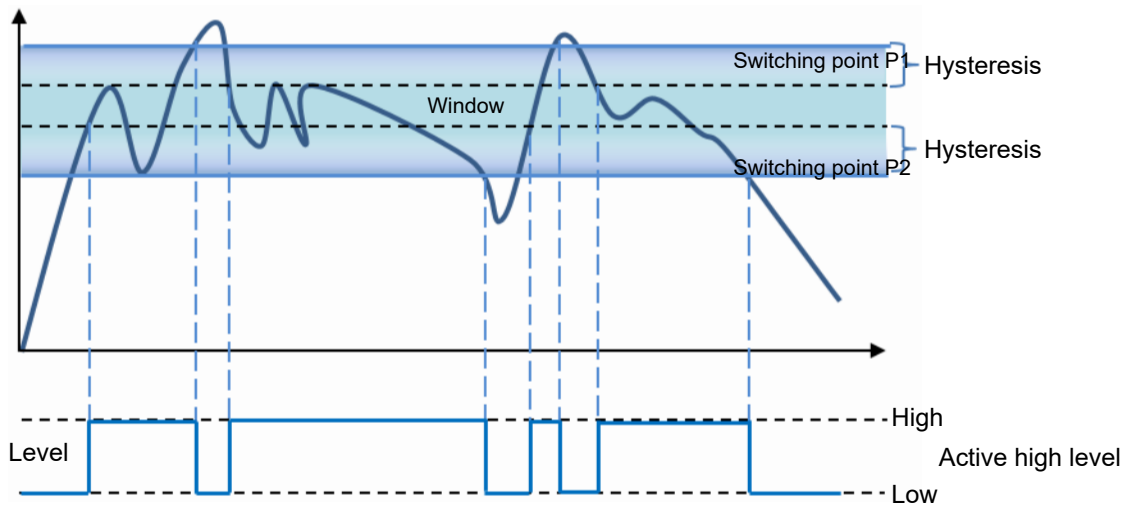

III. 49: Behaviour of the switching output in window mode (negative hysteresis)

Polarity

With **Polarity**, you can invert the level with **Active High** or **Active Low**.

11.6 Mode Save Parameter-Setups

You can save up to 32 parameter setups in the **Save Parameter-Setups** mode. In addition, you have the option to export and re-import parameter setups. External storage is in the .json format. The JSON file can be transferred to sensors with identical type code (measurement range and interface). The parameter setups can be renamed individually using the Web interface. Individual parameter setups can be saved, load or deleted. They are referenced via the process interfaces through use of a unique number, which can also be displayed in the Web interface.

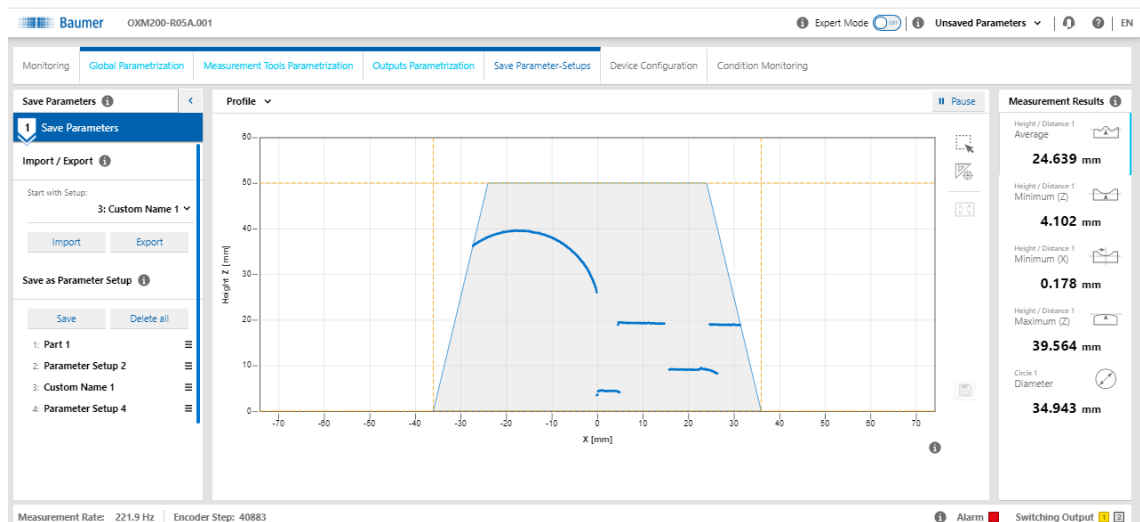

III. 50: Web interface – Save parameter setup mode

11.7 Mode Device Configuration

In **Device Configuration** mode, you can carry out device-specific settings.

III. 51: Web interface – Device Configuration mode

Sensor Info	<ul style="list-style-type: none"> Display of the sensor characteristics. Please pass on this information should you require customer service. The MAC address and production date are found on the name plate of the sensor (silver label on the sensor).
– Sensor Type	<ul style="list-style-type: none"> Display of the sensor type.
– Serial Number	<ul style="list-style-type: none"> Display of the serial number of the sensor.
Network	<ul style="list-style-type: none"> Selection between static and dynamic address configuration.
– Static IP Address	<ul style="list-style-type: none"> The sensor uses a fixed IP address.
– IP Address	<ul style="list-style-type: none"> Input IP Address.
– Subnet Mask	<ul style="list-style-type: none"> Input Subnet Mask.
– Standard Gateway	<ul style="list-style-type: none"> Input Standard Gateway.
– DHCP	<ul style="list-style-type: none"> Activation / deactivation DHCP. If DHCP is activated, the IP address will change to 0.0.0.0. A valid IP address must then be allocated by DHCP server or an appropriate tool. When activated, the IP address is shown solely for information purposes. If DHCP is deactivated, the IP address will be retained.
Time Synchronization	<ul style="list-style-type: none"> The time stamps of the measured values are set according to the synchronization. UTC is the time basis. Note: The daylight savings time function is not supported!

-	NTP	<ul style="list-style-type: none"> ■ Activation/deactivation of the NTP synchronization: When NTP is activated, the sensor synchronises its internal clock with a defined time server of the network.
-	Time Server	<ul style="list-style-type: none"> ■ Input Time Server of the network.
	Process Interface	<ul style="list-style-type: none"> ■ Activation/deactivation of the process interfaces. ■ If deactivated, the sensor no longer responds to queries via this protocol. ■ The protocols can be used in parallel. ■ Profinet is deactivated on delivery so that the sensor can be put into operation without control.
-	Realtime Ethernet	<ul style="list-style-type: none"> ■ Activation/deactivation of Profinet IO. ■ Activation/deactivation of Ethernet/IP. ■ After the sensor has been activated and restarted, the IP address of the sensor is set to 0.0.0.0 so that automatic detection of the sensor is possible within each infrastructure.
-	Modbus TCP	<ul style="list-style-type: none"> ■ Activation/deactivation of Modbus TCP. ■ See also Modbus TCP [▶ 29].
-	OPC UA	<ul style="list-style-type: none"> ■ Activation/deactivation of OPC UA. ■ See also OPC UA [▶ 33].
-	UDP Streaming	<ul style="list-style-type: none"> ■ Activation/deactivation of UDP Streaming. ■ See also UDP [▶ 39].
	Web Interface & Firmware	<ul style="list-style-type: none"> ■ Display of the web interface software and firmware version. ■ Uploading updated web interface software (.img format) and firmware (.fup format). <ul style="list-style-type: none"> ▪ It is possible to install a more recent revision of the firmware on the sensor, as long as the compatibility of the firmware is not excluded by the release notes. ▪ Downgrading the firmware is also possible. However, only down to the firmware with which the sensor was delivered.
-	Security	<ul style="list-style-type: none"> ■ Activation/deactivation of Password Protection.
-	Factory Reset	<ul style="list-style-type: none"> ■ Resetting the sensor to factory settings.
-	Settings Reset	<ul style="list-style-type: none"> ■ Resetting the sensor settings. The IP address is not reset in this process.

12 Maintenance

The sensor is maintenance-free. No special preventive maintenance is required. Regular cleaning and visual inspection of the plug connections are recommended.

12.1 Cleaning the sensor

External cleaning

When cleaning the exterior of the sensor, make sure to use cleaning agents that do not affect the housing surface and seals.

NOTICE

Material damage due to improper cleaning.

Unsuitable cleaning agents and methods can cause leaks and damage the sensor, the seals or the connections.

- a) Always check the suitability of the cleaning agent for the surface to be cleaned.
 - b) Use alcohol-based cleaning agents but never any scouring agents, solvents or other aggressive cleaning agents.
 - c) Never use a high-pressure cleaner for cleaning.
 - d) Do not scrape off soiling with sharp-edged items.
 - e) Only use lens cleaning cloths for the front pane of the sensor.
-

Interior cleaning

No interior cleaning of the sensor is required.

13 Troubleshooting

CAUTION

Release of dangerous laser radiation when the sensor is defective.

Use of the sensor with a fractured front panel or loose/exposed laser optics can release dangerous laser radiation.

- a) In case of a fractured front panel or loose/exposed laser optics disconnect the laser from the power immediately.
- b) Have the sensor checked by an authorised person (specialist). Do not operate the sensor until that time.

13.1 Resetting the sensor to the factory settings

Resetting the sensor to the factory settings is necessary, for instance, if the IP address of the sensor was changed and you can no longer connect to the sensor. Proceed as follows:

Instruction:

- a) Disconnect the sensor from the power supply. If the sensor is supplied with power via PoE, also disconnect the Ethernet connection.
- b) Connect pin 6 (OUT 1) and pin 8 (OUT 2) (see [Pin assignment](#) [▶ 55]).
- c) Connect pin 1 and pin 11 (power 24 V) as well as sensor pin 2 and pin 12 (GND) to power supply.
- d) Connect to the sensor as described at [Connecting the sensor to the PC](#) [▶ 58]. Apply the default settings.
 - ✓ A particular page opens.
- e) Select **Factory Default** and wait for the response from the sensor.
- f) Disconnect pin 6 (OUT 1) and pin 8 (OUT 2).
- g) Select **Restart sensor**.

Result:

- ✓ Sensor default has been restored.

13.2 Return and repair

In case of complaints, please contact the relevant sales company.

13.3 Disposal

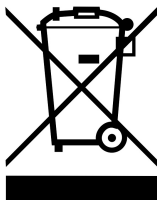

Do not dispose of electrical and electronic equipment in household waste. The product contains valuable raw materials for recycling, which is why the old product must be returned to an authorised collecting point for correct disposal/recycling. For further information see www.baumer.com.

13.4 Accessories

You can find accessories at the website at:

www.baumer.com

14 Technical data

The technical data for your sensor can be found in the data sheet available for download at www.baumer.com.

14.1 Dimensional drawing

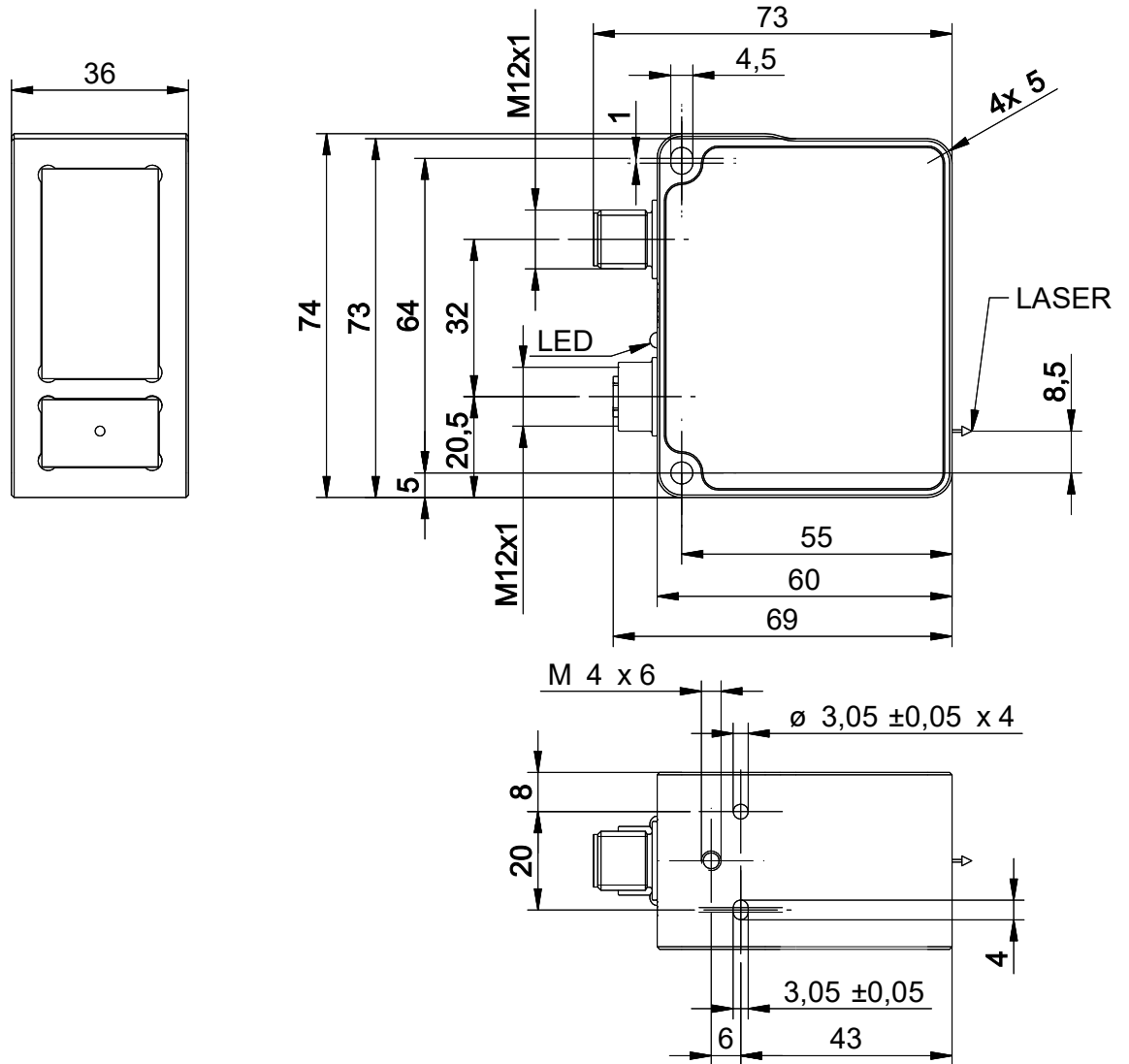

III. 52: OX200 – Dimensional drawing

List of illustrations

III. 1	Name plate on the sensor	7
III. 2	OX200 – Structure	10
III. 3	OX200 – Triangulation principle	11
III. 4	OXM200 - working principle	11
III. 5	EXP200 – working principle	11
III. 6	OX200 – Measurement rate limited by exposure time	13
III. 7	OX200 – Measurement rate limited by the processing time	13
III. 8	OX200 – Reference surfaces	14
III. 9	OX200 – Measurement field	14
III. 10	OX200 – Transmission and receiving axes	15
III. 11	Web interface – Overview	16
III. 12	OX200 – LEDs on the sensor	17
III. 13	OPC UA – UaExpert Client – Surface	34
III. 14	Web interface – Mode Outputs Parametrization – UDP	40
III. 15	UDP – Packet framing example	41
III. 16	UDP – Body recomposition example	41
III. 17	SDK – Structure	44
III. 18	Encoder – 2-channel operation	49
III. 19	Load new Parameter Setup (success)	50
III. 20	Load new parameter setup (error)	51
III. 21	OX200 - lateral mount	53
III. 22	OX200 – head mounting	54
III. 23	Ethernet connection, M12 8-pin, X-coded, female	55
III. 24	OXM200 – Electrical connection, M12 12-pin, A-coded, male	56
III. 25	EXP200 – Electrical connection, M12 12-pin, A-coded, male	56
III. 26	Entering the IP address of the sensor	58
III. 27	OXM200 – Electrical connection, M12 12-pin, A-coded, male	76
III. 28	Web interface – user interface	77
III. 29	Web interface – Monitoring mode	80
III. 30	Web interface – Global Parametrization mode	81
III. 31	Web interface – Parametrisation mode – Result over Time & Profile view	82
III. 32	Web interface – Parametrisation mode – Profile & Camera Picture view	83
III. 33	Web interface – Parametrisation mode – Intensity & Camera Picture view	84
III. 34	Web interface – Parametrisation mode – Profile & Intensity view	85
III. 35	Web interface – Parametrisation mode – Profile view	86
III. 36	Inclination angle and distance to the reference surface	90
III. 37	Reference point for angled installation	91
III. 38	Inclination angle and distance to the reference surface with angled installation	92

III. 39	Minimum length of the the reference surface $L_{R, \min}$	93
III. 40	Flex Mount: Moving the reference surface.....	93
III. 41	Web interface – Measurement Tools Parametrization mode.....	95
III. 42	Position tracking (ROI tracking).....	96
III. 43	Background tracking.....	96
III. 44	Negative hysteresis.....	100
III. 45	Positive hysteresis.....	100
III. 46	Behaviour of the switching output in point mode (positive hysteresis).....	101
III. 47	Behaviour of the switching output in point mode (negative hysteresis).....	101
III. 48	Behaviour of the switching output in window mode (positive hysteresis).....	101
III. 49	Behaviour of the switching output in window mode (negative hysteresis).....	102
III. 50	Web interface – Save parameter setup mode.....	102
III. 51	Web interface – Device Configuration mode.....	103
III. 52	OX200 – Dimensional drawing.....	107

