

Overview

- 5 ... 10 mm
- voltage output
- cable, 2 m
- 60 °C
- IP 67



Picture similar



Technical data

General data

Mounting type	Flush
Measuring distance Sd	5 ... 10 mm
Reference distance	7.1 ... 7.9 mm
Measuring speed	< 1.5 mm / ms
Repeat accuracy	0.02 mm
Linearity error	± 200 µm
Temperature coefficient	1 µm / (K mm)

Electrical data

Voltage supply range +Vs	15 ... 30 VDC
Current consumption max. (no load)	20 mA
Output circuit	Analog 1 ... 9 VDC
Load resistance	> 1000 Ohm
Residual output ripple	< 0.5 % Vs

Electrical data

Short circuit protection	Yes
Reverse polarity protection	Yes

Mechanical data

Design	Cylindrical threaded
Material (sensing face)	PBT
Housing material	Brass nickel plated
Dimension	30 mm
Housing length	60 mm
Connection types	Cable, L=2 m
Tightening torque max.	200 Nm (Front: 140 Nm)

Ambient conditions

Operating temperature	0 ... +60 °C
Protection class	IP 67

Dimension drawing

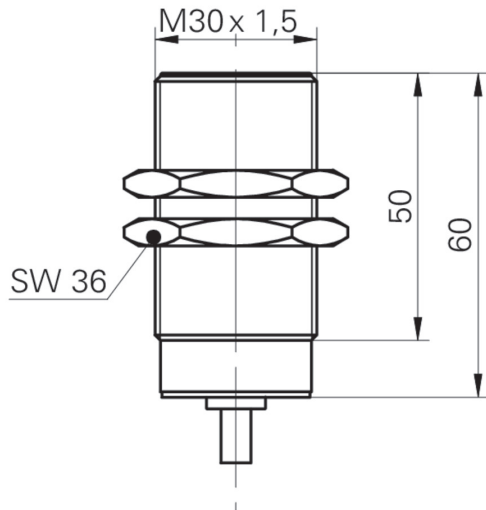

Connection diagram

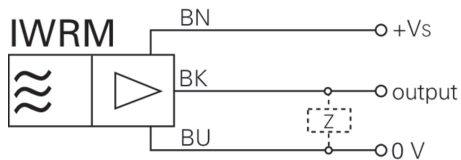

Accessories

Mounting accessories

11200030	11200030
11199998	ZADAP-M30.STANDARD
11199999	ZADAP-M30.LONG
11707685	Mounting rod with mounting plate holder 200 mm
11707686	Mounting rod with mounting plate holder 300 mm
11707688	Mounting rod 200 mm
11707697	Mounting rod 250 mm
11707698	Mounting rod with mounting plate holder 250 mm
11707687	Mounting rod 300 mm
11707700	Mounting plate \varnothing 30 mm
11707702	Mounting base
11707703	Two-way connector