

Vue d'ensemble

- M12, female, A-coded; 8-poles; TPE-S, 2000 cm, shielded, free cable end
- Dragchain capable
- Head A: IP65, IP68, IP69K
- Halogen free



Caractéristiques techniques

Side A		Cable	
Head A: Connection	M12	Cable length	2000 cm
Head A: Angle cable outlet	90°	Acceleration (C-track)	max. 2 m/s ²
Head A: Gender	Female	Bending radius (fixed)	min. 7,5 × outer diameter
Head A: Coding	A	Bending radius (mobile)	min. 10 × outer diameter
Head A: No. of poles	8	Cable weight	approx. 66 g/m
Head A: LED	No	Conductor structure	32 × 0,1 mm
Head A: Width across flats	AF14	Cable diameter	6,7 mm ± 5%
Head A: Tightening torque	0,6 Nm	Conductor: Material	Copper, bare
Head A: Knurled nut material	Stainless steel (V4A)	External sheath: Material	TPE-S
Head A: Body color	Blue	Insulation: Material	PP
Head A: Gasket material	EPDM	Shielding: Material	Copper, tinned
Labeling sleeve side A	No	No. of bending cycles (C-track)	approx. 2000000 Cycles
Side B		Nominal voltage	300 V AC
Head B: Connection	Open-ended wires	Paired stranding	No
Labeling sleeve side B	No	Single wire diameter	0,1 mm
Cables		Cable: Test voltage	3 kV
Cable length	2000 cm	Total stranding	8 wires strand around core-filler
Length tolerance	± 30 cm	Travel speed (C-track)	max. 3,3 m/s
Stripping length	60 mm	Traversing path (horizontal)	max. 5 m
Shielded	Oui	Wire cross section	0,25 mm ²
Conductor structure	32 × 0,1 mm	Wire processing	No
External sheath: Material	TPE-S	Wire diameter incl. isolation	1,25 mm ± 5%
External sheath: Color	Blue	External sheath: Color	Blue
Cable diameter	6,7 mm ± 5%	Données électriques	
Wire cross section	0,25 mm ²	Operating voltage	max. 30 V AC/DC
Cable		Nominal voltage	300 V AC
External sheath: Shore hardness	47 ± 5 D	Contact resistance	max. 30 mOhm
Cable: Temperature range (mobile)	- 20 ...+ 105 °C	Operating current per contact	max. 2 A
Cable: Temperature range (fixed)	- 40 ...+ 105 °C	Données mécaniques	
Shielded	Oui	Head A: Degree of protection	IP65, IP68, IP69K
Shielding: Covering	approx. 85 %	Bending radius (mobile)	min. 10 × outer diameter
Bending radius (fixed)	50,25 mm	Bending radius (fixed)	min. 7,5 × outer diameter
Number of wires	8	No. of bending cycles (C-track)	approx. 2000000 Cycles
Number and diameter of wires	8x0,25	Acceleration (C-track)	max. 2 m/s ²
Length tolerance	± 30 cm	Travel speed (C-track)	max. 3,3 m/s

Caractéristiques techniques

Conditions ambiantes

Temperature range (mobile)	- 20 ...+ 105 °C
Temperature range (fixed)	- 40 ...+ 105 °C
Cable: Temperature range (fixed)	- 40 ...+ 105 °C
Dragchain capable	Oui
Head A: Chemical resistance	Chemical resistance tested according to ECOLAB. If other media are used, the material resistance must be tested according to the application.

Conditions ambiantes

Head A: Oil resistance	ASTM 1 oil, mineral oils, limited to hydraulic oils
Head A: Acid and alkali resistant	ECOLAB tested
Cable: Flame resistance	HB (UL 94)
Cable: Acid and alkali resistant	Good (FDA 21 178.3620, 178.3297, 177.1520, EU 10/2011)
Cable: Silicone-free	Oui

Commercial data

Eclass	27060311
--------	----------

Side A

Technical drawing

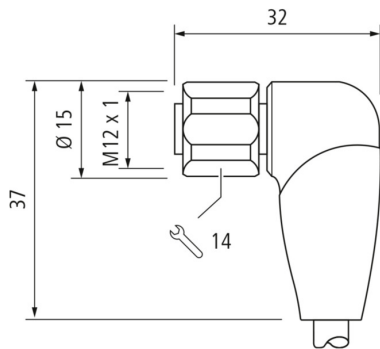

Side B

Technical drawing

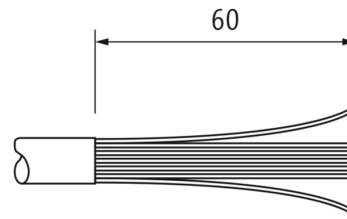

Coding



Schéma de raccordement



Dessin d'encombrement

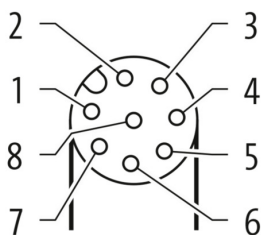
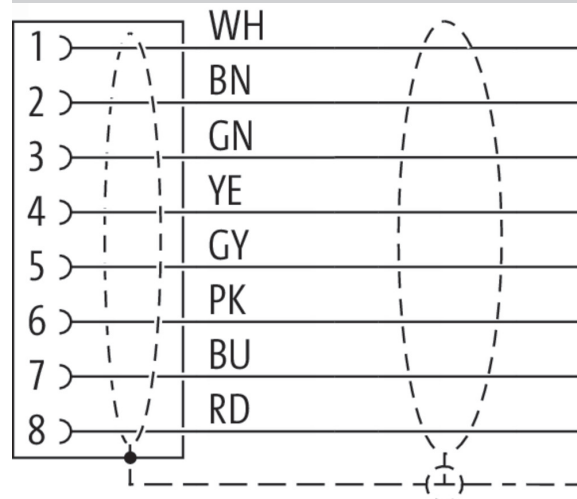