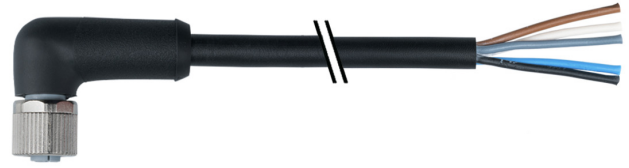

Vue d'ensemble

- M12, female, L-coded; 5-poles; PUR, 100 cm, free cable end
- Dragchain capable; suitable for robotics $\pm 180^\circ/\text{m}$
- Head A: IP65, IP67
- Cable: good resistance against chemicals, flames, oils
- Halogen free

Caractéristiques techniques
Side A

Head A: Connection	M12
Head A: Angle cable outlet	90°
Head A: Gender	Female
Head A: Coding	L
Head A: No. of poles	5
Head A: LED	No
Head A: Width across flats	AF17
Head A: Tightening torque	0,6 Nm
Head A: Knurled nut material	Zinc-pressure die casting, surface Ni
Head A: Body color	Black
Head A: Gasket material	FKM
Labeling sleeve side A	Yes

Side B

Head B: Connection	Open-ended wires
Labeling sleeve side B	Yes

Cables

Cable length	100 cm
Length tolerance	+ 5 cm
Stripping length	100 mm
Shielded	No
Conductor structure	84 × 0,15 mm
AWG	16
External sheath: Material	PUR
External sheath: Color	Black
Cable diameter	8,7 mm \pm 5%
Wire cross section	1.5 mm ²

Cable

Cable: Temperature range (mobile)	- 20 ...+ 80 °C
Cable: Temperature range (fixed)	- 50 ...+ 80 °C
Shielded	No
Bending radius (fixed)	65,25 mm
Number of wires	5
Number and diameter of wires	5x1,5
Length tolerance	+ 5 cm
Cable length	100 cm
Acceleration (C-track)	max. 5 m/s ²

Cable

AWG	16
Bending radius (fixed)	min. 7,5 × outer diameter
Torsion speed	max. 35 cycles/min
Bending radius (mobile)	min. 10 × outer diameter
Cable type	3
Cable weight	approx. 129,8 g/m
Conductor structure	84 × 0,15 mm
Cable diameter	8,7 mm \pm 5%
Conductor: Material	Copper, bare
External sheath: Material	PUR
Insulation: Material	PP
No. of bending cycles (C-track)	approx. 500000 Cycles
Nominal voltage	1000 V AC
No. of torsion cycles	approx. 200000 Cycles
Paired stranding	No
Single wire diameter	0,15 mm
Cable: Test voltage	10 kV
Torsion stress in °	$\pm 180^\circ/\text{m}$
Total stranding	5 wires strand around core-filler
Travel speed (C-track)	max. 3,3 m/s
Traversing path (horizontal)	max. 5 m
Wire cross section	1.5 mm ²
Wire processing	No
Wire diameter incl. isolation	2,3 mm \pm 5%
External sheath: Color	Black

Données électriques

Operating voltage	max. 63 V DC
Nominal voltage	1000 V AC
Contact resistance	max. 30 mOhm
Operating current per contact	max. 12 A

Données mécaniques

Head A: Degree of protection	IP65, IP67
Bending radius (mobile)	min. 10 × outer diameter
Bending radius (fixed)	min. 7,5 × outer diameter
No. of bending cycles (C-track)	approx. 500000 Cycles
Torsion speed	max. 35 cycles/min

Caractéristiques techniques

Données mécaniques

Torsion stress in °	± 180 °/m
No. of torsion cycles	approx. 2000000 Cycles
Acceleration (C-track)	max. 5 m/s ²
Travel speed (C-track)	max. 3,3 m/s

Conditions ambiantes

Temperature range (mobile)	- 20 ...+ 80 °C
Temperature range (fixed)	- 25 ...+ 80 °C
Cable: Temperature range (fixed)	- 50 ...+ 80 °C
Dragchain capable	Oui
Head A: Chemical resistance	No

Conditions ambiantes

Head A: Flame resistance	V-2 (UL 94)
Head A: Acid and alkali resistant	No
Head A: Pollution degree	3
Cable: Chemical resistance	Good (DIN EN 60811-404)
Cable: Flame resistance	Conform UL 1581 VW-1, CSA FT1, IEC 60332-1, IEC 60332-2-2
Cable: Oil resistance	Good (DIN EN 60811-404)
Cable: Silicone-free	Oui

Commercial data

Eclass	27060311
--------	----------

Side A

Technical drawing

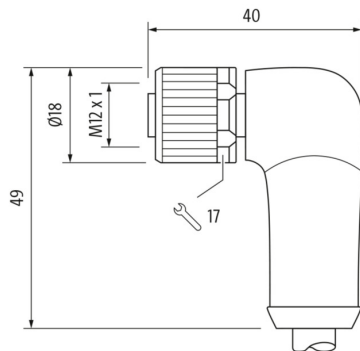

Side B

Technical drawing

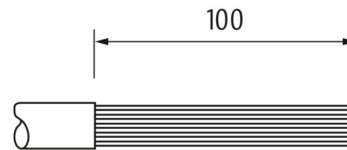

Coding



Schéma de raccordement



Dessin d'encombrement

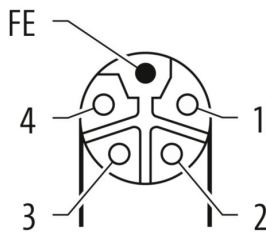
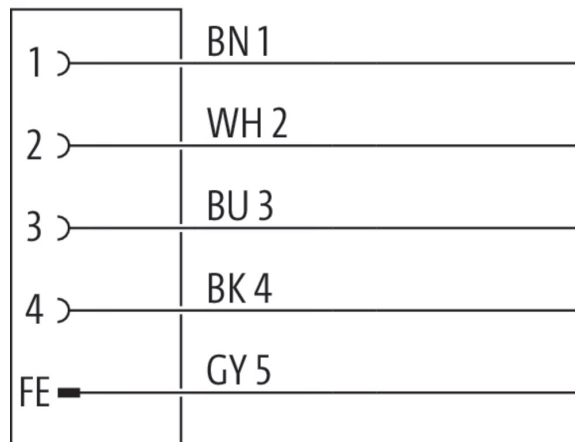