

Overview

- M8, female, A-coded; 4-poles; TPE, 500 cm, free cable end
- Dragchain capable, suitable for robotics, suitable for food & beverage
- Head A: IP65, IP66K, IP67, IP69
- Cable: Good resistance against chemicals, flames and oils
- Halogen free

Technical data
Side A

Head A: Connection	M8
Head A: Angle cable outlet	0°
Head A: Gender	Female
Head A: Coding	A
Head A: No. of poles	4
Head A: Tightening torque	0.6 Nm
Head A: Knurled nut material	Stainless steel (V4A)
Head A: Gasket material	EPDM

Side B

Head B: Connection	Open-ended wires
--------------------	------------------

Cables

Cable length	500 cm
Stripping length	0 mm
Conductor structure	42 × 0.1 mm
AWG	22
External sheath: Material	TPE
External sheath: Color	Gray
Cable diameter	4.6 mm ± 5%
Wire cross section	0.34 mm ²

Cable

Cable: Temperature range (mobile)	- 40 ...+ 105 °C
Cable: Temperature range (fixed)	- 25 ...+ 105 °C
Bending radius (fixed)	23 mm
Cable length	500 cm
Acceleration (C-track)	≤ 10 m/s ²
AWG	22
Bending radius (fixed)	min. 5 × outer diameter
Bending radius (mobile)	min. 10 × outer diameter
Conductor structure	42 × 0.1 mm
Cable diameter	4.6 mm ± 5%
Insulation resistance	≥ 1000000 Ohm

Cable

Conductor: Material	Copper, bare
External sheath: Material	TPE
Insulation: Material	TPE
No. of bending cycles (C-track)	≥ 4000000 Cycles
Nominal voltage	240 V
Cable: Test voltage	2000 V 0
Travel speed (C-track)	≤ 3 m/s
Traversing path (horizontal)	≤ 10 m
Wire cross section	0.34 mm ²
External sheath: Color	Gray

Electrical data

Operating voltage	240 V
Nominal voltage	240 V
Contact resistance	≤ 5 mOhm
Operating current per contact	max. 4 A

Mechanical data

Head A: Degree of protection	IP65, IP67, IP68, IP69
Bending radius (mobile)	min. 10 × outer diameter
Bending radius (fixed)	min. 5 × outer diameter
No. of bending cycles (C-track)	≥ 4000000 Cycles
Acceleration (C-track)	≤ 10 m/s ²
Travel speed (C-track)	≤ 3 m/s

Environmental conditions

Temperature range (mobile)	- 25 ...+ 105 °C
Temperature range (fixed)	- 40 ...+ 105 °C
Cable: Temperature range (fixed)	- 25 ...+ 105 °C
Dragchain capable	Yes
Head A: Pollution degree	3
Cable: Chemical resistance	Good

Side A

Technical drawing

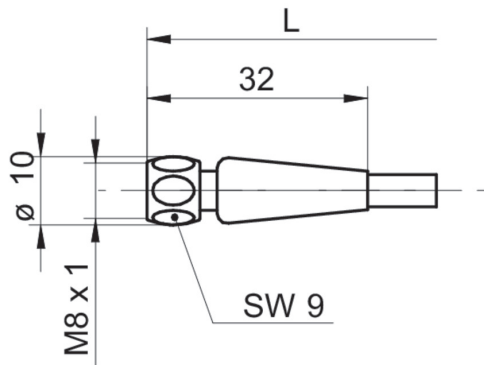

Connection diagram

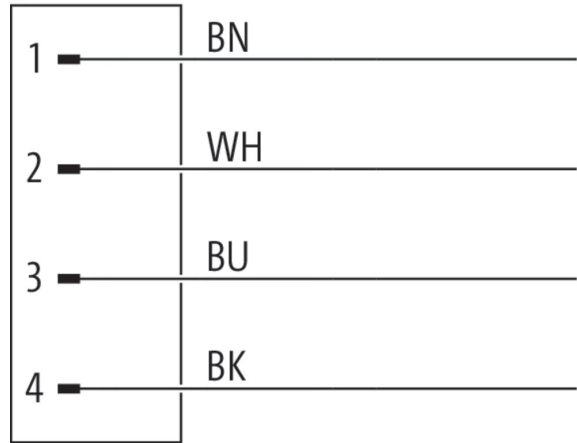

Coding

