

Overview

- M12, female, A-coded; 4-poles; PVC, 300 cm, free cable end
- Suitable for food & beverage
- Head A: IP65, IP68
- Cable: good resistance against chemicals, flames

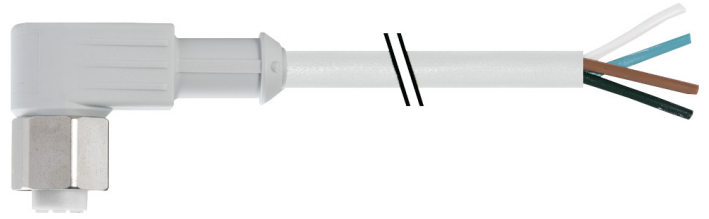

Technical data

Side A

Head A: Connection	M12
Head A: Angle cable outlet	90°
Head A: Gender	Female
Head A: Coding	A
Head A: No. of poles	4
Head A: LED	No
Head A: Width across flats	AF14
Head A: Tightening torque	0.6 Nm
Head A: Knurled nut material	Stainless steel (V4A)
Head A: Body color	Gray
Head A: Gasket material	FKM
Labeling sleeve side A	No

Side B

Head B: Connection	Open-ended wires
Labeling sleeve side B	No

Cables

Cable length	300 cm
Length tolerance	+ 10 cm
Stripping length	20 mm
Shielded	No
Conductor structure	19 × 0.15 mm
AWG	22
External sheath: Material	PVC
External sheath: Color	Gray
Cable diameter	5 mm ± 5%
Wire cross section	0.34 mm ²

Cable

Cable: Temperature range (mobile)	- 5 ...+ 80 °C
Cable: Temperature range (fixed)	- 30 ...+ 80 °C
Operating voltage (only UL listed)	30 V AC/DC
Shielded	No
Bending radius (fixed)	25 mm
Number of wires	4
Number and diameter of wires	4x0.34
Length tolerance	+ 10 cm

Cable

Cable length	300 cm
AWG	22
Bending radius (fixed)	min. 5 × outer diameter
Cable type	1
Cable weight	approx. 40.7 g/m
Conductor structure	19 × 0.15 mm
Cable diameter	5 mm ± 5%
Conductor: Material	Copper, bare
External sheath: Material	PVC
Insulation: Material	PVC
Nominal voltage	300 V AC
Paired stranding	No
Single wire diameter	0.15 mm
Cable: Test voltage	2 kV
Total stranding	4 wires strand
Wire cross section	0.34 mm ²
Wire processing	No
Wire diameter incl. isolation	1.25 mm ± 5%
External sheath: Color	Gray

Electrical data

Operating voltage	max. 250 V AC/DC
Operating voltage (only UL listed)	30 V AC/DC
Nominal voltage	300 V AC
Contact resistance	max. 30 mOhm
Operating current per contact	max. 4 A

Mechanical data

Head A: Degree of protection	IP65, IP68
Bending radius (fixed)	min. 5 × outer diameter

Environmental conditions

Temperature range (mobile)	- 5 ...+ 80 °C
Temperature range (fixed)	- 25 ...+ 80 °C
Cable: Temperature range (fixed)	- 30 ...+ 80 °C
Dragchain capable	No
Head A: Chemical resistance	No

Technical data

Environmental conditions

Head A: Flame resistance	HB (UL 94)
Head A: Oil resistance	ASTM 1 oil, mineral oils, limited to hydraulic oils
Head A: Acid and alkali resistant	No
Head A: Pollution degree	3
Cable: Chemical resistance	Good

Environmental conditions

Cable: Flame resistance	Conform UL 1581 VW-1, CSA FT1, IEC 60332-1-2
Cable: Oil resistance	Good
Cable: Silicone-free	Yes

Commercial data

Eclass	27060311
--------	----------

Side A

Technical drawing

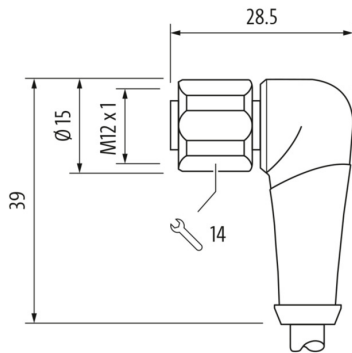

Side B

Technical drawing

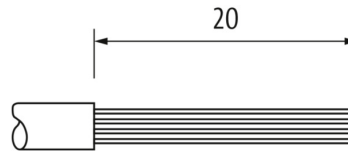

Coding

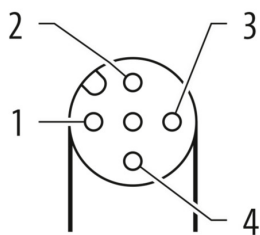

Connection diagram

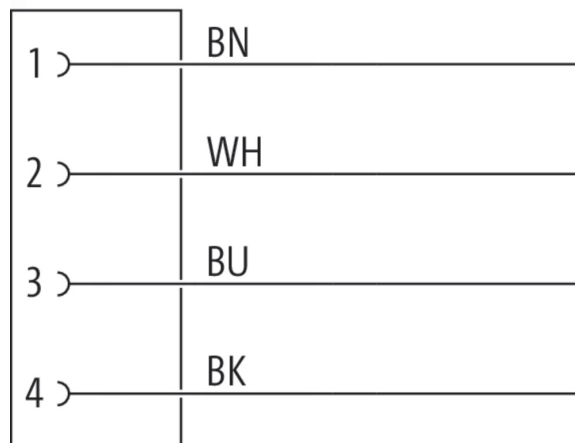

Dimension drawing

