

Overview

- M12, female, A-coded; 3-poles; PUR, 300 cm, shielded, free cable end
- Dragchain capable
- Head A: IP65, IP66K, IP67
- Cable: good resistance against chemicals, flames, oils
- Halogen free



Technical data

Side A		Cable	
Head A: Connection	M12	Length tolerance	+ 10 cm
Head A: Angle cable outlet	90°	Cable length	300 cm
Head A: Gender	Female	Acceleration (C-track)	max. 5 m/s ²
Head A: Coding	A	AWG	22
Head A: No. of poles	3	Bending radius (fixed)	min. 5 × outer diameter
Head A: LED	No	Torsion speed	max. 35 cycles/min
Head A: Width across flats	AF13	Bending radius (mobile)	min. 10 × outer diameter
Head A: Tightening torque	0.6 Nm	Cable type	3
Head A: Knurled nut material	Zinc-pressure die casting, surface Ni	Cable weight	approx. 44 g/m
Head A: Body color	Black	Conductor structure	42 × 0.1 mm
Head A: Gasket material	FKM	Cable diameter	5 mm ± 5%
Labeling sleeve side A	Yes	Conductor: Material	Copper, bare
Side B		External sheath: Material	PUR
Head B: Connection	Open-ended wires	Insulation: Material	PP
Labeling sleeve side B	Yes	Shielding: Material	Copper, tinned
Cables		No. of bending cycles (C-track)	approx. 500000 Cycles
Cable length	300 cm	Nominal voltage	300 V
Length tolerance	+ 10 cm	No. of torsion cycles	approx. 2000000 Cycles
Stripping length	20 mm	Paired stranding	No
Shielded	Yes	Single wire diameter	0.1 mm
Conductor structure	42 × 0.1 mm	Cable: Test voltage	2 kV AC core-core ; 2 kV AC core-shield
AWG	22	Torsion stress in °	± 30 °/m
External sheath: Material	PUR	Total stranding	3 wires strand
External sheath: Color	Black	Travel speed (C-track)	max. 3.3 m/s
Cable diameter	5 mm ± 5%	Traversing path (horizontal)	max. 5 m
Wire cross section	0.34 mm ²	Wire cross section	0.34 mm ²
Cable		Wire processing	No
Cable: Temperature range (mobile)	- 25 ...+ 80 °C	Wire diameter incl. isolation	1.25 mm ± 5%
Cable: Temperature range (fixed)	- 40 ...+ 80 °C	External sheath: Color	Black
Operating voltage (only UL listed)	30 V AC/DC	Electrical data	
Shielded	Yes	Operating voltage	max. 60 V AC/DC
Shielding: Covering	approx. 80 %	Operating voltage (only UL listed)	30 V AC/DC
Bending radius (fixed)	25 mm	Nominal voltage	300 V
Number of wires	3	Contact resistance	max. 30 mOhm
Number and diameter of wires	3x0.34	Operating current per contact	max. 4 A

2024-07-16 The product features and technical data specified do not express or imply any warranty. Technical modifications subject to change.

Technical data

Mechanical data

Head A: Degree of protection	IP65, IP66K, IP67
Bending radius (mobile)	min. 10 × outer diameter
Bending radius (fixed)	min. 5 × outer diameter
No. of bending cycles (C-track)	approx. 5000000 Cycles
Torsion speed	max. 35 cycles/min
Torsion stress in °	± 30 °/m
No. of torsion cycles	approx. 2000000 Cycles
Acceleration (C-track)	max. 5 m/s ²
Travel speed (C-track)	max. 3.3 m/s

Environmental conditions

Temperature range (mobile)	- 25 ...+ 80 °C
Temperature range (fixed)	- 25 ...+ 80 °C
Cable: Temperature range (fixed)	- 40 ...+ 80 °C

Environmental conditions

Dragchain capable	Yes
Head A: Chemical resistance	No
Head A: Flame resistance	HB (UL 94)
Head A: Oil resistance	ASTM 1 oil, mineral oils, limited to hydraulic oils
Head A: Acid and alkali resistant	No
Head A: Pollution degree	3
Cable: Chemical resistance	Good (DIN EN 60811-404)
Cable: Flame resistance	Conform UL 1581 §1090 (H), CSA FT2, IEC 60332-2-2
Cable: Oil resistance	Good (DIN EN 60811-404)
Cable: Silicone-free	Yes

Commercial data

Eclass	27060311
--------	----------

Side A

Technical drawing

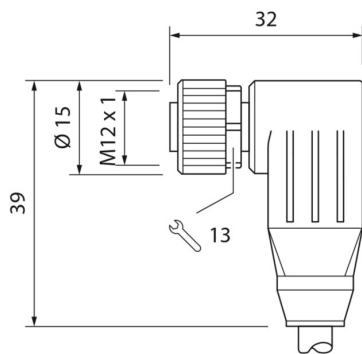

Side B

Technical drawing



Coding

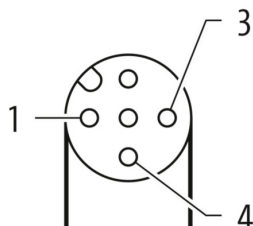

Connection diagram



Dimension drawing

