

Vue d'ensemble

- M8, female, A-coded, 3-poles; PUR, 100 cm, free cable end
- Dragchain capable; suitable for robotics $\pm 180^\circ/\text{m}$
- Head A: IP65, IP66K, IP67
- Cable: good resistance against chemicals, flames, oils
- Halogen free

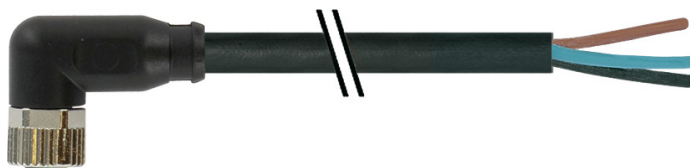

Caractéristiques techniques

Side A		Cable	
Head A: Connection	M8	Cable length	100 cm
Head A: Angle cable outlet	90°	Acceleration (C-track)	max. 10 m/s ²
Head A: Gender	Female	AWG	24
Head A: Coding	A	Bending radius (fixed)	min. 5 × outer diameter
Head A: No. of poles	3	Torsion speed	max. 35 cycles/min
Head A: LED	No	Bending radius (mobile)	min. 10 × outer diameter
Head A: Width across flats	AF9	Cable type	3
Head A: Tightening torque	0,4 Nm	Cable weight	approx. 26,4 g/m
Head A: Knurled nut material	Zinc-pressure die casting, surface Ni	Conductor structure	32 × 0,1 mm
Head A: Body color	Black	Cable diameter	4,1 mm ± 5%
Head A: Gasket material	FKM	Conductor: Material	Copper, bare
Labeling sleeve side A	Yes	External sheath: Material	PUR
Side B		Insulation: Material	PP
Head B: Connection	Open-ended wires	No. of bending cycles (C-track)	approx. 10000000 Cycles
Labeling sleeve side B	Yes	Nominal voltage	300 V
Cables		No. of torsion cycles	approx. 2000000 Cycles
Cable length	100 cm	Paired stranding	No
Length tolerance	+ 5 cm	Single wire diameter	0,1 mm
Stripping length	20 mm	Cable: Test voltage	2,5 kV
Shielded	No	Torsion stress in °	± 180 °/m
Conductor structure	32 × 0,1 mm	Total stranding	3 wires strand
AWG	24	Travel speed (C-track)	max. 3 m/s
External sheath: Material	PUR	Traversing path (horizontal)	max. 10 m
External sheath: Color	Black	Wire cross section	0,25 mm ²
Cable diameter	4,1 mm ± 5%	Wire processing	No
Wire cross section	0,25 mm ²	Wire diameter incl. isolation	1,25 mm ± 5%
Cable		External sheath: Color	Black
Cable: Temperature range (mobile)	- 25 ...+ 80 °C	Données électriques	
Cable: Temperature range (fixed)	- 40 ...+ 80 °C	Operating voltage	max. 50 V AC / 60 V DC
Operating voltage (only UL listed)	30 V AC/DC	Operating voltage (only UL listed)	30 V AC/DC
Shielded	No	Nominal voltage	300 V
Bending radius (fixed)	20,5 mm	Contact resistance	max. 30 mOhm
Number of wires	3	Operating current per contact	max. 4 A
Number and diameter of wires	3x0,25	Données mécaniques	
Length tolerance	+ 5 cm	Head A: Degree of protection	IP65, IP66K, IP67
		Bending radius (mobile)	min. 10 × outer diameter

Caractéristiques techniques

Données mécaniques

Bending radius (fixed)	min. 5 × outer diameter
No. of bending cycles (C-track)	approx. 10000000 Cycles
Torsion speed	max. 35 cycles/min
Torsion stress in °	± 180 °/m
No. of torsion cycles	approx. 2000000 Cycles
Acceleration (C-track)	max. 10 m/s ²
Travel speed (C-track)	max. 3 m/s

Conditions ambiantes

Temperature range (mobile)	- 25 ...+ 80 °C
Temperature range (fixed)	- 25 ...+ 80 °C
Cable: Temperature range (fixed)	- 40 ...+ 80 °C
Dragchain capable	Oui

Conditions ambiantes

Head A: Chemical resistance	No
Head A: Flame resistance	HB (UL 94)
Head A: Oil resistance	ASTM 1 oil, mineral oils, limited to hydraulic oils
Head A: Acid and alkali resistant	No
Head A: Pollution degree	3
Cable: Chemical resistance	Good (DIN EN 60811-404)
Cable: Flame resistance	Conform UL 1581 §1090 (H), CSA FT2, IEC 60332-2-2
Cable: Oil resistance	Good (DIN EN 60811-404)
Cable: Silicone-free	Oui

Commercial data

Eclass	27060311
--------	----------

Side A

Technical drawing

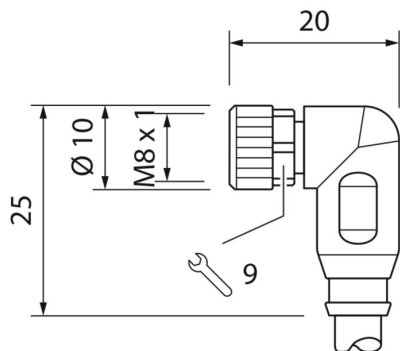

Side B

Technical drawing

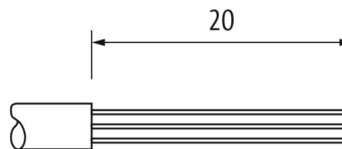

Coding



Schéma de raccordement



Dessin d'encombrement

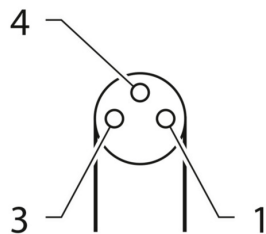
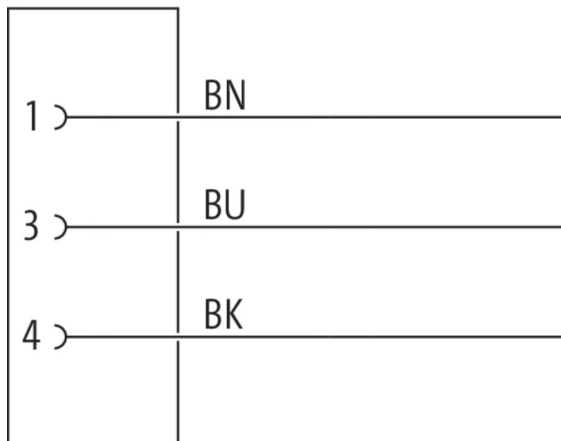