

Vue d'ensemble

- M12, male, A-coded, 4-poles; PUR, 500 cm, shielded; M12, female, A-coded, 4-poles
- Dragchain capable
- Head A: IP65, IP66K, IP67; Head B: IP65, IP66K, IP67
- Cable: good resistance against chemicals, flames, oils
- Halogen free



Caractéristiques techniques

Side A		Cable	
Head A: Connection	M12	Cable: Temperature range (fixed)	- 40 ...+ 80 °C
Head A: Angle cable outlet	0°	Operating voltage (only UL listed)	30 V AC/DC
Head A: Gender	Male	Shielded	Oui
Head A: Coding	A	Shielding: Covering	approx. 80 %
Head A: No. of poles	4	Bending radius (fixed)	26,5 mm
Head A: LED	No	Number of wires	4
Head A: Width across flats	AF13	Number and diameter of wires	4x0,34
Head A: Tightening torque	0,6 Nm	Length tolerance	± 7,5 cm
Head A: Knurled nut material	Zinc-pressure die casting, surface Ni	Cable length	500 cm
Head A: Body color	Black	Acceleration (C-track)	max. 5 m/s ²
Labeling sleeve side A	Yes	AWG	22
Side B		Bending radius (fixed)	min. 5 × outer diameter
Head B: Connection	M12	Torsion speed	max. 35 cycles/min
Head B: Angle cable outlet	90°	Bending radius (mobile)	min. 10 × outer diameter
Head B: Gender	Female	Cable type	3
Head B: Coding	A	Cable weight	approx. 50,6 g/m
Head B: No. of poles	4	Conductor structure	42 × 0,1 mm
Head B: LED	No	Cable diameter	5,3 mm ± 5%
Head B: Width across flats	AF13	Conductor: Material	Copper, bare
Head B: Tightening torque	0,6 Nm	External sheath: Material	PUR
Head B: Knurled nut material	Zinc-pressure die casting, surface Ni	Insulation: Material	PP
Head B: Body color	Black	Shielding: Material	Copper, tinned
Head B: Gasket material	FKM	No. of bending cycles (C-track)	approx. 5000000 Cycles
Labeling sleeve side B	Yes	Nominal voltage	300 V
Cables		No. of torsion cycles	approx. 2000000 Cycles
Cable length	500 cm	Paired stranding	No
Length tolerance	± 7,5 cm	Single wire diameter	0,1 mm
Shielded	Oui	Cable: Test voltage	2 kV AC core-core ; 2 kV AC core-shield
Conductor structure	42 × 0,1 mm	Torsion stress in °	± 30 °/m
AWG	22	Total stranding	4 wires strand
External sheath: Material	PUR	Travel speed (C-track)	max. 3,3 m/s
External sheath: Color	Black	Traversing path (horizontal)	max. 5 m
Cable diameter	5,3 mm ± 5%	Wire cross section	0,34 mm ²
Wire cross section	0,34 mm ²	Wire processing	No
Cable		Wire diameter incl. isolation	1,25 mm ± 5%
Cable: Temperature range (mobile)	- 25 ...+ 80 °C		

Caractéristiques techniques

Cable

External sheath: Color Black

Données électriques

Operating voltage max. 60 V AC/DC

Operating voltage (only UL listed) 30 V AC/DC

Nominal voltage 300 V

Contact resistance max. 30 mOhm

Operating current per contact max. 4 A

Données mécaniques

Head A: Degree of protection IP65, IP66K, IP67

Head B: Degree of protection IP65, IP66K, IP67

Bending radius (mobile) min. 10 × outer diameter

Bending radius (fixed) min. 5 × outer diameter

No. of bending cycles (C-track) approx. 5000000 Cycles

Torsion speed max. 35 cycles/min

Torsion stress in ° ± 30 °/m

No. of torsion cycles approx. 2000000 Cycles

Acceleration (C-track) max. 5 m/s²

Travel speed (C-track) max. 3,3 m/s

Conditions ambiantes

Temperature range (mobile) - 25 ...+ 80 °C

Temperature range (fixed) - 25 ...+ 80 °C

Conditions ambiantes

Cable: Temperature range (fixed) - 40 ...+ 80 °C

Dragchain capable Oui

Head A: Chemical resistance No

Head A: Flame resistance HB (UL 94)

Head A: Oil resistance ASTM 1 oil, mineral oils, limited to hydraulic oils

Head A: Acid and alkali resistant No

Head A: Pollution degree 3

Head B: Chemical resistance No

Head B: Flame resistance HB (UL 94)

Head B: Oil resistance ASTM 1 oil, mineral oils, limited to hydraulic oils

Head B: Acid and alkali resistant No

Head B: Pollution degree 3

Cable: Chemical resistance Good (DIN EN 60811-404)

Cable: Flame resistance Conform UL 1581 §1090 (H), CSA FT2, IEC 60332-2-2

Cable: Oil resistance Good (DIN EN 60811-404)

Cable: Silicone-free Oui

Commercial data

Eclass 27060311

Side A

Technical drawing



Side A

Coding

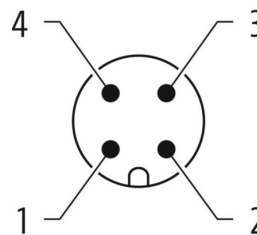

Side B

Technical drawing

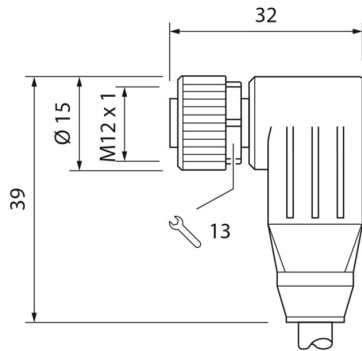

Dessin d'encombrement



Coding



Schéma de raccordement

