

## EN580E.IL-SU06.GB1T2.01024.K

Solid shaft with synchro flange, 1024 pulses per revolution

Article number: 11246010

### Overview

- Size ø58 mm
- Precise optical sensing
- Output signal level TTL
- Pulses per revolution 1024
- Connection: flange connector M23, 12-pin, CCW



### Technical data

#### Technical data - electrical ratings

|                             |                             |
|-----------------------------|-----------------------------|
| Voltage supply              | 5 VDC ±5 %                  |
| Reverse polarity protection | Yes                         |
| Short-circuit proof         | Yes (max. 1 s and 1 signal) |
| Consumption w/o load        | ≤70 mA                      |
| Pulses per revolution       | 1024                        |
| Phase shift                 | 90 ° ±10°                   |
| Duty cycle                  | 40...60 %                   |
| Reference signal            | Zero pulse, width 90° ±10 % |
| Sensing method              | Optical                     |
| Output frequency            | ≤300 kHz (TTL)              |
| Output signals              | A+, B+, R+, A-, B-, R-      |
| Output stages               | TTL/RS422                   |
| Interference immunity       | EN 61000-6-2                |
| Emitted interference        | EN 61000-6-4                |
| Approval                    | UL-Listing: E217823         |

#### Technical data - mechanical design

|                       |   |
|-----------------------|---|
| Size (flange)         | ø58 mm  |
| Shaft type            | ø6 x 10 mm, solid shaft with flat   |
| Admitted shaft load   | ≤40 N axial<br>≤80 N radial   |
| Flange                | Synchro flange  |
| Protection EN 60529   | IP 54 (flange side)<br>IP 65 (housing side)                                 |
| Operating speed       | ≤6000 rpm (+25 °C)  |
| Starting torque       | ≤0.02 Nm  |
| Material              | Housing: aluminium<br>Solid shaft: stainless steel                          |
| Operating temperature | -25...+100 °C (see general information)                                     |
| Relative humidity     | 95 % non-condensing   |
| Resistance            | EN 60068-2-6 Vibration 30 g, 10-2000 Hz<br>EN 60068-2-27 Shock 100 g, 11 ms |
| Connection            | Flange connector M23, 12-pin, CCW   |
| Weight approx.        | 300 g   |

# EN580E.IL-SU06.GB1T2.01024.K

Solid shaft with synchro flange, 1024 pulses per revolution

Article number: 11246010

## General information

Self-heating correlated to installation and ambient conditions as well as to electronics and supply voltage must be considered for precise thermal dimensioning. Operating the encoder close to the maximum limits requires measuring the real prevailing temperature at the encoder flange.

## Terminal assignment

Flange socket M23, 12-pin, male contact, CCW

| Pin | Assignment |
|-----|------------|
| 1   | B-         |
| 2   | +Vs Sense  |
| 3   | R+         |
| 4   | R-         |
| 5   | A+         |
| 6   | A-         |
| 7   | -          |
| 8   | B+         |
| 9   | -          |
| 10  | 0 V        |
| 11  | 0 V Sense  |
| 12  | +Vs        |

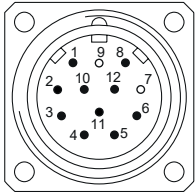

## Trigger level

| Outputs           | TTL/RS422            |
|-------------------|----------------------|
| Output level High | $\geq 2.5 \text{ V}$ |
| Output level Low  | $\leq 0.5 \text{ V}$ |
| Load              | $\leq 20 \text{ mA}$ |

| Outputs           | HTL/Push-pull            |
|-------------------|--------------------------|
| Output level High | $\geq U_B - 3 \text{ V}$ |
| Output level Low  | $\leq 1.5 \text{ V}$     |
| Load              | $\leq 20 \text{ mA}$     |

## Output signals

Clockwise rotating direction when looking at flange.

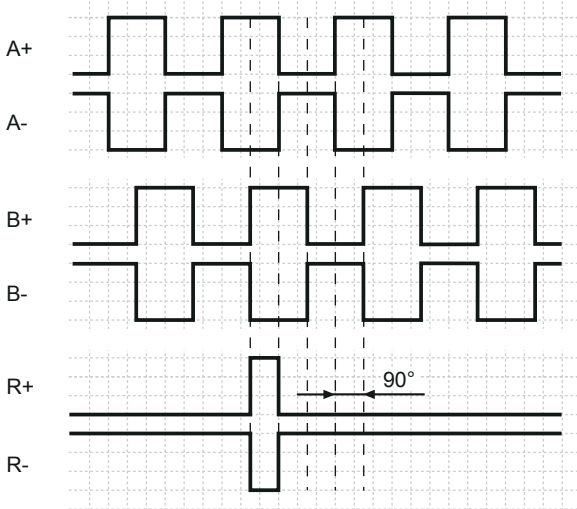

# EN580E.IL-SU06.GB1T2.01024.K

Solid shaft with synchro flange, 1024 pulses per revolution

Article number: 11246010

## Dimensions

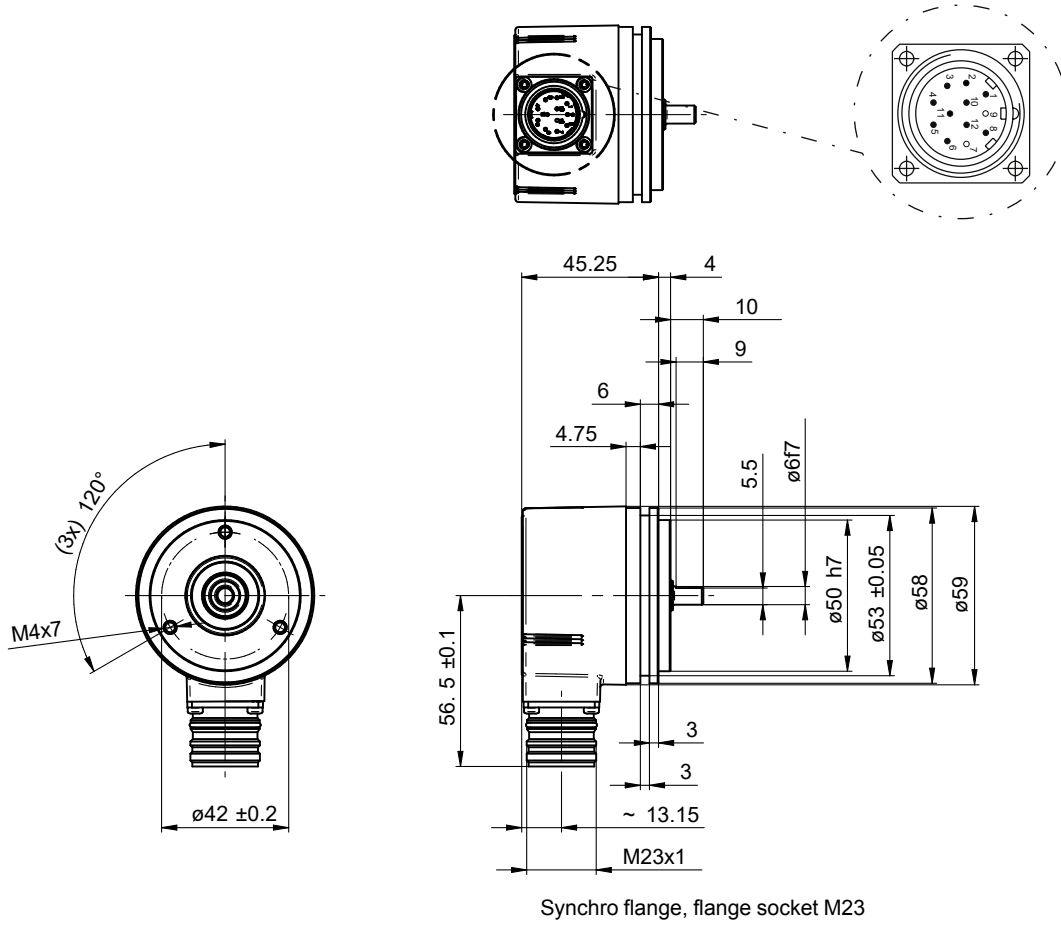

**Accessories****Mounting accessories**

|          |   |
|----------|---|
| 11050507 | Bellows coupling (D1=06 / D2=10)                          |
| 11065922 | Coupling CPS25 (L=19, D1=10 / D2=06)                      |
| 11065916 | Coupling CPS25 (L=19, D1=06 / D2=06)                      |
| 10141132 | Spring washer coupling (D1=6 / D2=10)                     |
| 10141131 | Spring washer coupling (D1=6 / D2=6)                      |
| 11069333 | Coupling CPS37 (L=24, D1=06 / D2=06)                      |
| 11069337 | Coupling CPS37 (L=24, D1=10 / D2=06)                      |
| 11065545 | Set of eccentric fixings type A                           |
| 10117667 | Mounting adaptor  |
| 10117668 | Set of eccentric fixings for mounting clamp<br>(10117667) |