

Manual

Absolute Encoder Profibus-DPV0 (with bus cover and SSI coupler)

Firmware version from 1.20

Contents

	Page
1. Introduction	3
1.1. Scope of delivery	3
1.2. Product assignment	4
2. Safety and operating instructions	5
3. Product families	6
4. Profibus-DP	7
5. Encoder operating parameters	8
6. Data exchange between Profibus-DP devices	9
6.1. Telegram structure	9
6.2. Initialization, restarting and user data communication	9
7. Parameterization and configuration	10
7.1. Parameterization	10
7.2. Configuration	13
8. Diagnostic signals	14
8.1. Description of the diagnosis data Slave_Diag	14
8.2. Parameter values of the diagnosis data Slave_Diag	17
8.3. User data	18
8.4. Preset function	18
9. Entering parameters	19
10. Terminal assignment and commissioning	21
10.1. Mechanical mounting	21
10.2. Electrical connection	21
10.2.1. Setting the user address	21
10.2.2. Terminating resistor	22
10.2.3. Bus cover connection	22
10.2.4. Terminal assignment	25
10.3. Display element (status display)	25
10.3.1. Profibus cable	26

Disclaimer of liability

The present manual was compiled with utmost care, errors and omissions reserved. For this reason Baumer Germany GmbH & Co. KG rejects any liability for the information compiled in the present manual. Baumer Germany nor the author will accept any liability for direct or indirect damages resulting from the use of the present information.

At any time we should be pleased receiving your comments and proposals for further improvement of the present document.

Created by:

Baumer Germany GmbH & Co. KG
Bodenseeallee 7
DE-78333 Stockach
www.baumer.com

Registered trademarks

SIEMENS®, SIMATIC®, Step7® und S7® are registered trademarks of Siemens AG. PROFIBUS, the PROFIBUS Logo and PROFIdrive are registered trademarks of the PROFIBUS user organization respectively of PROFIBUS International (PI). These and other names applied in the present manual that at the same time are registered trademarks are not correspondingly marked. Having omitted the respective marking does not necessarily imply that the names are not registered trademarks or that there are no existing patents and protected patented designs.

1. Introduction

1.1. Scope of delivery

Please check the delivery upon completeness prior to commissioning.
Depending on encoder configuration and part number delivery is including:

- Basic encoder
- Profibus bus cover
- Sealing bolt for any unused cable gland
- Describing file and manual (available as download on our website)

1.2. Product assignment

Shaft encoder

Product	GSD-file	Product family
GBAMW	GBAM059B.gsd	multivoPlus - Singleturn
GBMMW	GBMM059B.gsd	multivoPlus - Multiturn
GBLMW	GBMM059B.gsd	multivoPlus - Multiturn
GCAMW	GCAM059B.gsd	magtivo® - Singleturn
GCMMW	GCMM059B.gsd	magtivo® - Multiturn
GXAMW	GXAM059B.gsd	multivo® - Singleturn
GEMMW	GXMM059B.gsd	multivo® - Multiturn (stainless steel)
GXMLW	GXMM059B.gsd	multivo® - Multiturn
GXMMW	GXMM059B.gsd	multivo® - Multiturn
X 700	GXMM059B.gsd	multivo® - Multiturn

End shaft encoder

Product	GSD-file	Product family
GBAMS	GBAM059B.gsd	multivoPlus - Singleturn
GBMMS	GBMM059B.gsd	multivoPlus - Multiturn
GBLMS	GBMM059B.gsd	multivoPlus - Multiturn
GCAMS	GCAM059B.gsd	magtivo® - Singleturn
GCMMS	GCMM059B.gsd	magtivo® - Multiturn
GXAMS	GXAM059B.gsd	multivo® - Singleturn
GXLMS	GXMM059B.gsd	multivo® - Multiturn
GXMMS	GXMM059B.gsd	multivo® - Multiturn

Hollow shaft encoder

Product	GSD-file	Product family
G0AMH	GXAM059B.gsd	multivo® - Singleturn
G0MMH	GXMM059B.gsd	multivo® - Multiturn
G0LMH	GXMM059B.gsd	multivo® - Multiturn
G1AMH	GXAM059B.gsd	multivo® - Singleturn
G1MMH	GXMM059B.gsd	multivo® - Multiturn
G2AMH	GXAM059B.gsd	multivo® - Singleturn
G2MMH	GXMM059B.gsd	multivo® - Multiturn
GBAMH	GBAM059B.gsd	multivoPlus - Singleturn
GBLMH	GBMM059B.gsd	multivoPlus - Multiturn
GBMMH	GBMM059B.gsd	multivoPlus - Multiturn
GEMMH	GXMM059B.gsd	multivo® - Multiturn (stainless steel)
GFMMH	GXMM059B.gsd	multivo® - Multiturn (stainless steel)

Interface converter

Product	GSD-file	Product family
GK410	GXMM059B.gsd	multivo® - Multiturn

2. Safety and operating instructions

Intended use

- The encoder is a precision measuring device that is used to record positions and speeds. It provides measuring values as electronic output signals for the subsequently connected device. It must not be used for any other purpose. Unless this product is specially labeled, it may not be used for operation in potentially explosive environments.
- Make sure by appropriate safety measures, that in case of error or failure of the encoder, no danger to persons or damage to the system or operating facilities occurs.

Personnel qualification

- Installation and assembly of this product may be performed only by a person qualified in electronics and precision mechanics.

Maintenance

- The encoder is maintenance-free and must not be opened up nor mechanically or electronically modified. Opening up the encoder can lead to injury.

Disposal

- The encoder contains electronic components. At its disposal, local environmental guidelines must be followed.

Mounting

- Solid shaft: Do not connect encoder shaft and drive shaft rigidly. Connect drive and encoder shaft with a suitable coupling.
- Hollow shaft: Open clamping ring completely before mounting the encoder. Foreign objects must be kept at a sufficient distance from the stator coupling. The stator coupling is not allowed to have any contact to the encoder or the machine except at the mounting points.

Electrical commissioning

- Do not proceed any electrical modifications at the encoder.
- Do not proceed any wiring work while encoder is live.
- Do not remove or plug on connector whilst under power supply.
- Ensure that the entire system is installed in line with EMC/EMI requirements. Operating environment and wiring have an impact on the electromagnetic compatibility of the encoder. Install encoder and supply cables separately or far away from sources with high emitted interference (frequency converters, contactors, etc.).
- When working with consumers with high emitted interference provide separate encoder supply voltage.
- Completely shield encoder housing and connecting cables.
- Connect encoder to protective earth (PE) using shielded cables. The braided shield must be connected to the cable gland or connector. Ideally, aim at dual connection to protective earth (PE), i.e. housing by mechanical assembly and cable shield by the downstream devices.

Supplementary information

- The present manual is intended as a supplement to already existing documentation (e.g. catalogues, data sheets or mounting instructions).

3. Product families

The product family architecture is modular. Depending on what is required from the encoder, the basic encoder and bus covers can be combined at will with the selected bus system.

The basic encoders differ in terms of accuracy, ambient conditions and the utilized sensing principle.

Bus cover

The bus cover accommodates the entire electronics for measured value processing and for Ethernet communication.

The bus covers differ by the respectively integrated bus interface.

Available bus interfaces: CANopen®, DeviceNet, EtherCAT, Ethernet/IP, Profibus-DP, Profinet, Powerlink, Power over EtherCAT, SAE J1939, SSI.

All encoders enable parameterization by bus interface.

Functional principle:

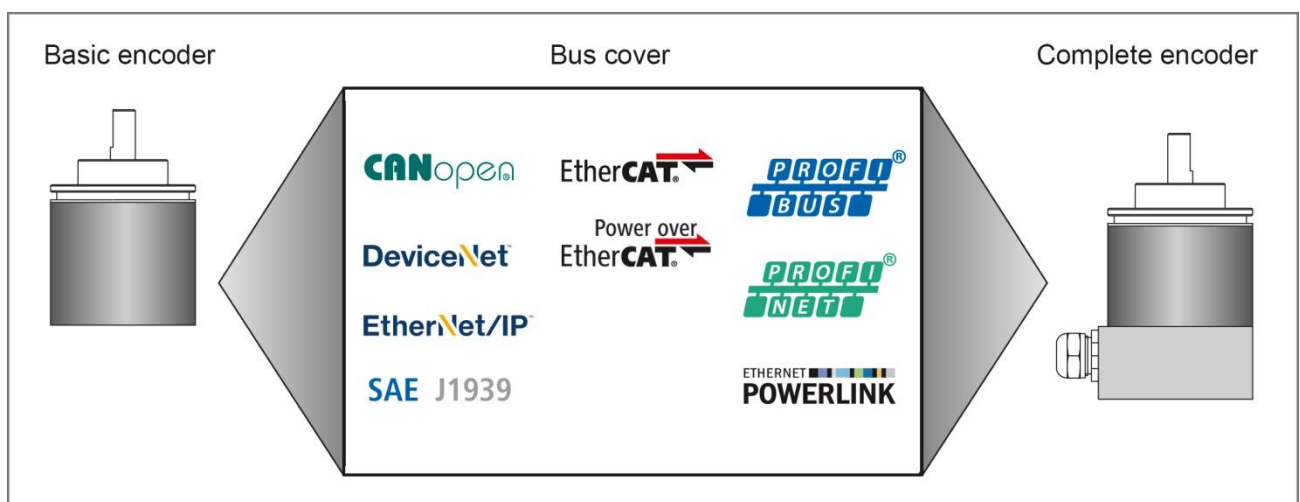

Speed signal

Baumer Profibus encoders with bus cover concept permit readout of the current rotary speed. There are four different scaling systems available:

- RPM
Readout of the speed in revolutions per minute.
- Steps/s
Readout of the speed in units of the parameterized singleturn resolution per second. The speed is measured over a period of 200 ms in each case and then updated.
- Steps/100 ms
Readout of the speed in units of the parameterized singleturn resolution per 100 ms.
- Steps/10 ms
Readout of the speed in units of the parameterized singleturn resolution per 10 ms.

4. Profibus-DP

General

Bus systems are connecting structures which generate communication between several components. The Profibus-DP is a manufacturer-independent open communication system for applications in the fields of production, process and building automation. It is broken down into three variants:

- Profibus FMS for data communication between control units on the production and process management level.
- Profibus PA for process engineering applications.
- Profibus DP for fast data exchange between control units and decentral peripherals in automation engineering applications.

The Profibus system comprises the following device types:

- DP master class 1 (DPM1) is a control system which cyclically exchanges information with a DP slave.
- DP master class 2 (DPM2) are programming or project processing devices or controllers.
- DP slave is a peripheral device which receives output data and forwards input data to the programmable logic controller.

The Profibus system is broken down into a monomaster system and a multimaster system by the number of active masters in operation during the operating phase.

- In a monomaster system, only one master class 1 and the DP slaves are active in the bus.
- In a multimaster system, several masters and the DP slaves are active in the bus. The masters can optionally either belong to class 1 or class 2.

The Profibus DP is characterized by the following features:

- Short response times (1 ms with 32 users and 12 MBaud)
- Reliable transmission procedure (Hamming distance 4)
- Availability of a wide range of standardized system components
- Good diagnostic capability
- Simple handling and facility for upgrading
- User-oriented bus system
- Open system

Profibus-DP is standardized by standard EN 50170 Vol. 2. This standard defines the communication and user profiles. The user profile for interface converters is profile 1.1. The user profile is differentiated depending on the number of supported functions according to device class 1 and 2. Device class 2 has a greater number and contains all the functions of class 1. Parameterization and preset functions are supported only by class 2. The device supports classes 1 and 2.

GSD file

The device master data file (GSD file) is a descriptive file which describes all the encoder data required for operation. The data itself is filed in the ROM of the encoder. The data can be subdivided into two sections.

- General definitions contain information such as the manufacturer's name, product designation, Ident. number, Profibus-specific parameters and baud rates.
- Application-related definitions include configuration possibilities, parameters, parameter descriptions, hardware and software status and diagnostic possibilities.

The format and content are defined in line with the EN 50170 standard.

The GSD file has the ident no. 059B for all the described products. This GSD file is an essential condition for parameterization and configuration of the encoder with a configuration tool.

5. Encoder operating parameters

Description of operating parameters

Parameter	Significance
Sense of rotation	Behaviour of the output code depending on the sense of rotation of the shaft seen looking at the flange CW = Increasing values with clockwise rotation CCW = Increasing values with counterclockwise rotation
Resolution	Number of steps per revolution, input in integral steps
Measurement range	Total resolution = number of steps per revolution x number of revolutions, input in integral steps
Preset value	A certain output value is assigned to the current position value (referencing)

Operating parameter values

Parameter	Value range	Default setting	Data type
Sense of rotation	CW/CCW	CW	Octet string
Resolution	1 to 4096 – magtivo 1 to 8192 – multivo 1 to 262144 – activo/multivoPlus	4096 8192 262144	Unsigned 32
Measurement range	1 to 67108864 (2^{26}) – magtivo 1 to 536870912 (2^{29}) – multivo 1 to 2147483648 (2^{31}) – activo/multivoPlus	67108864 536870912 2147483648	Unsigned 32
Preset value	0 to (measurement range - 1 step)	0	Unsigned 32

6. Data exchange between Profibus-DP devices

6.1. Telegram structure

The diagram illustrates the telegram structure.

Telegram structure

DP Master	Triggering telegram			DP Slave
	Footer info	Output data	Header info	
	Reply telegram			
	Header info	Input data	Footer info	

6.2. Initialization, restarting and user data communication

Before an exchange of useful information between the master and slave, every slave is re-initialized. The master transmits parameterization and configuration data to the slave. Only when the parameterization and configuration data is in agreement with the data stored in the slave can user data be exchanged. This takes place in the following way:

Diagnostic request from the master

The master transmits a Diagnosis Request to a slave (Slave_Diag), and the slave responds with a Slave Diagnosis Response.

The master uses this data to check whether the slave exists in the bus and is ready for parameterization and configuration.

Parameterization of the slave

The master transmits a Parameter Request to the slave (Set_Prm).

The Slave receives information about the current bus parameters, surveillance times and slave-specific parameters via the parameterization data. The parameters are taken over during the project processing phase partially directly or indirectly from the GSD file. The slave compares this parameterization data with its own stored data.

Configuration of the slave

The master transmits a Check Configuration Request (Chk_Cfg).

The master informs the slave of the scope (number of data bytes) and the structure (data consistency) of the input and output ranges to be exchanged. The slave compares this configuration with its own configuration.

Diagnosis request prior to data exchange

The master transmits another Slave Diagnosis Request (Slave_Diag), the slave answers with a Slave Diagnosis Response.

The master now checks whether the parameterization and configuration agree with the data stored in the slave. If the data requested by the master is admissible and if no error exists, the slave signals its readiness for the transfer of user data by means of the diagnosis data.

Data Exchange

The slave now responds exclusively to the master which has parameterized and configured it.

The master transmits a user data request (Data_Exchange), the slave answers with a user data response. In this response, the slave informs the master whether current diagnosis results are available. The slave only makes known the actual diagnosis and status information after the master's diagnosis telegram.

7. Parameterization and configuration

7.1. Parameterization

Parameterization refers to the transfer of information which the slave requires for exchanging process data. The information comprises Profibus-specific data (Octets 1 to 6) and user-specific information. The user-specific information can be entered via an input window during the project processing phase. The slave compares the data transmitted by the master with the data it has stored. However, the slave does not inform the master of the result until the diagnosis request following configuration.

Description of parameters for the parameterization function (Set_Prm)

Device class	Parameter	Octet no.	Significance
1	Station status	1	Definition of Profibus-specific data <ul style="list-style-type: none"> • Sync mode/freeze mode active • Response monitoring active • Master assigned
1	Response monitoring time	2 to 3	Recognition of master failure, master must respond within this period
1	Min. station delay responder (tsdr)	4	Minimum time which the slave must wait until it may respond to a request by the master
1	Ident_number	5 to 6	Device identifier which must be unique for each type of device, saved and reserved by the PNO
1	Group_ident_number	7	Profibus-specific data
1	Operating parameter	8	Profibus-specific data
1	Operating parameter	9	Definition of application-specific data <ul style="list-style-type: none"> • Counting direction • Functional scope of the encoder, defined in appliance class 1 and 2 • Scaling function
2	Single-turn resolution	10 to 13	Definition of the number of measurement steps per revolution
2	Total resolution in steps	14 to 17	Definition of the total resolution in steps Total resolution is the number of measurement steps x the number of revolutions
2	Scaling the speed signal	26	Definition of the unit of measurement in which the speed signal (if selected) is read out (e.g. rpm)

Value of parameters of the parameterization function (Set_Prm)

Device class	Parameter	Data type	Octet no.	Value range	Default value In the GSD file
1	Station status	Octet string	1		<ul style="list-style-type: none"> • Sync and freeze mode supported • Supported baud rates
1	Response monitoring time	Octet string	2 to 3		Profibus-specific data
1	Minimum Station Delay Responder	Octet string	4		Baud rate dependent
1	Ident number	Octet string	5 to 6		059B
1	Group ident no.	Octet string	7		00
1	Operating parameter	Octet string	8		Profibus-specific data
1	Operating parameter	Octet string	9	<ul style="list-style-type: none"> • Bit 0 = 0/1 CW/CCW • Bit 1 = 0/1 Device class 2 off/on • Bit 3 = 0/1 Scaling function off/on 	<ul style="list-style-type: none"> • CW • Class 2 Device class 2 on • Scaling function on
2	Signal turn resolution	Unsigned 32	10 to 13	Octet 10 is MSB 1 to 1024 – magtivo 1 to 8192 – multivo 1 to 262144 – activo/multivoPlus	1024 8192 262144
2	Total resolution in steps	Unsigned 32	14 to 17	Octet 14 is MSB 1 to 67108864 (2^{26}) – magtivo 1 to 536870912 (2^{29}) – multivo 1 to 2147483648 (2^{31}) – activo/multivoPlus	67108864 536870912 2147483648
2	Reserved (system-specific)		18 to 25		0
2	Scaling Speed signal	Octet string	26	0 to 3 0: steps/s 1: steps/100 ms 2: steps/10 ms 3: RPM	3

Important note for multiturn encoder operation

This encoder supports „Endless Operation“ automatically if required.

Thus, there are no special requirements for the encoder parameters “total measuring range” and “measuring units per revolution” to stand in a certain ratio.

With endless operation active, the encoder shaft must not rotate when the encoder is not powered. In those cases where powerless motion cannot be avoided, the encoder has to be referenced (presetted) after each power-up. With Endless Operation inactive, the encoder shaft may rotate unlimited when encoder not powered.

How to determine if „Endless Operation“ is in use:

- Multiply the encoder's „max. possible revolutions“ (depending on encoder 16 bit = 65536 or 13 bit = 8192) by your chosen parameter „measuring units per revolution“.
- Divide this value by your chosen „total measuring range“.
- If there is a division remainder, endless operation is in use.

Example for parameters without endless operation:

Maximum possible revolutions	65536	(16 bit multiturn)
Measuring units per revolution	3600	
Total measuring range	29.491.200	(8192 x 3600)
Calculation:	$65536 \times 3600 / 29.491.200 = 8$ (no remainder)	

Example for parameters with endless operation:

Maximum possible revolutions	65536	(16 bit multiturn)
Measuring units per revolution	3600	
Total measuring range	100.000	
Calculation:	$65536 \times 3600 / 100.000 = 2359$ remainder 29600	

7.2. Configuration

Configuration refers to the definition of type, length and data direction of the process data, as well as the way in which the data is further processed. The type stipulates the data type and whether the data is contiguous (consistent). The length determines the number of data bytes available for use. The data direction defines whether data is transferred from master to slave or vice versa. The encoder is able to read preset values or transmit position values and if applicable also transmit speed values. The length is optionally 1 or 2 words, and the data is consistent in both cases. The configuration is compared with the configuration stored in the slave. The slave informs the master of the result in the following diagnosis request.

The position values of the encoder from the view point of the master are input data, preset values and output data.

Admissible configurations

Device Class	Configuration	Significance
1	D1h	2 words input data with data consistency for position values to max. 31 bit
2	F1h	2 words output data with data consistency for preset value to max. 31 bit 2 words input data with data consistency for position values to max. 31 bit
1	D0h	1 word input data with data consistency for position values to max. 15 bit
2	F0h	1 word output data with data consistency for preset values to max. 15 bit 1 word input data with data consistency for position values to max. 15 bit
1	D1h, D0h	2 words input data with data consistency for position values to max. 31 bit 1 word input data with data consistency for speed values to max. 16 bit
2	F1h, D0h	2 words output data with data consistency for preset value to max. 31 bit 2 words input data with data consistency for position values to max. 31 bit 1 word input data with data consistency for speed values to max. 16 bit
1	D0h, D0h	1 word input data with data consistency for position values to max. 15 bit 1 word input data with data consistency for speed values to max. 16 bit
2	F0h, D0h	1 word output data with data consistency for preset values to max. 15 bit 1 word input data with data consistency for position values to max. 15 bit 1 word input data with data consistency for speed values to max. 16 bit

8. Diagnostic signals

Diagnostic signals contain data relating to the respective status of the encoder. The diagnostic signals comprise Profibus-relevant information and device-specific information. The master controls communication with the slave using this information, or forwards it to the higher-level system.

The master requests diagnosis data both prior to parameterization and after configuration of the slave.

This ensures that the slave is present in the bus and that the data stored in the control system software is in agreement with the data stored in the slave. The slave can also register a diagnosis event in the Data_Exchange mode. The master then requests the diagnosis data. The user-specific information is defined in the EN 50170 standard under Encoder profile 1.1.

The display element integrated in the bus cover (dual red/green LED) indicates part of this information.

8.1. Description of the diagnosis data Slave_Diag

Device class	Diagnosis data	Octet no.	Significance
1	Station status 1	1	Status of <ul style="list-style-type: none"> Parameterization Configuration Diagnostic data (Diag.ext. bit and Diag.stat. bit in case of alarm and warning signals)
1	Station status 2	2	Status of <ul style="list-style-type: none"> Response monitoring Freeze or Sync mode
1	Station status 3	3	Not supported
1	Diag_Master	4	Address of the master which first parameterized the slave
1	Ident_number	5 to 6	Device identifier <ul style="list-style-type: none"> Unique for each device type Reserved and stored with the PNO
1	Extended diagnosis header	7	Length of the encoder diagnosis including diagnosis header byte in the case of extended diagnosis
1	Alarm signals	8	Display of malfunctions which could lead to incorrect position values. Triggered by <ul style="list-style-type: none"> Code consistency error or inadmissible preset value Preset value is outside the admissible value range.
1	Operating status	9	Indication of supported user-specific data <ul style="list-style-type: none"> Counting direction Functional scope of the encoder, defined in device class 1 and 2 Extended diagnosis Scaling function
1	Encoder type	10	Indication of encoder type
1	Steps per revolution	11 to 14	Maximum resolution per revolution of the encoder
1	Number of revolutions	15, 16	Maximum number of revolutions of the encoder
2	Additional alarm signals	17	Not supported
2	Supported alarm signals	18	Indication of which alarm is supported <ul style="list-style-type: none"> Incorrect position value

Continued on next page.

Description of diagnosis data Slave_Diag (contd.)

Device class	Diagnosis data	Octet no.	Significance
2	Warnings	20, 21	Indicates when parameters are not within the admissible tolerance. In contrast to alarm signals, these events do not result in incorrect position values. <ul style="list-style-type: none"> Voltage of the lithium cell has dropped below the critical value (only multiturn encoders)
2	Supported warning signals	22, 23	Indicates which warning signal is supported <ul style="list-style-type: none"> Voltage of the lithium cell has dropped below the prescribed value (only multiturn encoders)
2	Profile version	24, 25	Profile version of the encoder profile in revision number and index
2	Software version	26, 27	Indicates the software version in revision number and index, identical to the indication on the rating plate of the encoder.
2	Operating hours counter	28 to 31	Not supported
2	Offset value	32 to 35	Indicates the offset value stored in the EEPROM after a preset
2	Manufacturer offset	36 to 39	Not supported, reserved for servicing purposes
2	Steps per revolution	40 to 43	Indicates the programmed steps per revolution of the encoder
2	Total resolution in steps	44 to 47	Indicates the programmed total resolution in steps of the encoder
2	Serial number	48 to 57	Not supported
2	Reserved	58, 59	Not supported, reserved for servicing purposes

**Alarm signal position error**

The alarm signal is triggered by two events:

- Code consistency error due to a malfunction in the optoelectronic/magnetic system
Preset value outside the admissible value range

The angular position of the shaft is sampled cyclically via the encoded glass panel. Two consecutive position values are compared to each other. If the value change exceeds a certain number of steps, the last position value is implausible.

The encoder sets the Ext_diag. bit and bit 0 to the alarm signal status.

In case of a code consistency error, the Ext_diag. bit is automatically reset after 2.5 s. If a further event occurs during this time, the period is automatically extended by 2.5 s.

In the event of an inadmissible preset value, the Ext_diag bit remains set until the master has transmitted the correct value.

Code consistency errors and inadmissible preset values are indicated by the display element in the bus cover.

**Warning signal lithium cell voltage (only multiturn encoders)**

If the encoder is receiving no operating voltage, the internal lithium cell supplies the necessary supply voltage for the part of the circuit necessary for counting revolutions and storing them in the ASIC. When the operating voltage is switched on, the stored value is read out, the position change within one revolution is picked up by the optoelectronic or magnetic singleturn system. Position changes in the OFF status are brought about for example by run-on of the shaft or subsequent manual adjustment.

The lithium cell voltage is internally monitored. If the voltage drops below the prescribed value, the encoder internally sets the Diag_ext error bit and indicates the event via bit 5 in the warning signal. However, the revolution counting and saving functions are only guaranteed for a certain time when powered by the lithium cell.

Once this period is exhausted, the encoder must be decommissioned or permanently powered by an external voltage supply.

The amount of time for which the encoder can continue to be operated depends on recognition of the event.

- Status signal already exists at encoder power on.
If the time of first occurrence is not known, the encoder must be withdrawn from service immediately.
- Status signal occurs during operation in the Data_Exchange mode.
Once the status signal is active, the encoder will continue to function for several weeks without problems before it needs to be exchanged.

8.2. Parameter values of the diagnosis data Slave_Diag

Device class	Diagnostic data	Data type	Octet no.	Value range
1	Station status	Octet string	1 to 3	Profibus-specific data
1	Diag_master	Octet string	4	Profibus-specific data
1	Ident_number	Octet string	5 to 6	059B
1	Extended diagnosis	Octet string	7	16 byte with class 1 57 byte with class 2
1	Alarm signals	Octet string	8	Bit 0 = 1 position error
1	Operating status	Octet string	9	Bit 0 = 0 Cw Bit 0 = 1 Ccw Bit 1 = 1 (Encoder supported Class 2 Functionality) Bit 3 = Scaling function on/off
1	Encoder type	Octet string	10	01h = Multiturn / 00h = Singleturn
1	Singleturn resolution	Unsigned 32	11 to 14	Octet 11 is MSB 1 to 4096 – magtivo 1 to 8192 – multivo 1 to 262144 – activo/multivoPlus
1	Number of revolutions	Unsigned 16	15, 16	Octet 15 is MSB 1 to 65535 – magtivo 1 to 65535 – multivo 1 to 8192 – activo/multivoPlus
2	Additional alarm signals	Octet string	17	Not supported
2	Supported alarm signals	Octet string	18, 19	Octet 19 Bit 0 = 1 Position error supported
2	Warnings	Octet string	20, 21	Octet 21 Bit 5 = 1 Lithium cell voltage drops below specified value (only multiturn encoder)
2	Supported warning signals	Octet string	22, 23	Octet 2 is MSB Bit 5 = 1 lithium cell voltage (only multiturn encoder) supported
2	Profile version	Octet string	24, 25	Encoder profile 1.10
2	Software version	Octet string	26, 27	Additional stored on the rating plate
2	Hours-run counter	Octet string	28 to 31	Not supported
2	Offset value	Octet string	32 to 35	Dependent on preset value
2	Manufacturer offset	Octet string	36 to 39	Not supported
2	Steps per revolution	Unsigned 32	40 to 43	Octet 40 is MSB 1 to 4096 – magtivo 1 to 8192 – multivo 1 to 262144 – activo/multivoPlus
2	Total resolution in steps	Unsigned 32	44 to 47	Octet 44 is MSB 1 to 67108864 (2^{26}) – magtivo 1 to 536870912 (2^{29}) – multivo 1 to 2147483648 (2^{31}) – activo/multivoPlus
2	Serial number	ASCII string	48 to 57	Not supported, all digits (Octet) "*" corresponds to "2Ah"
2	Reserved	Octet string	58, 59	Reserved for servicing purposes

8.3. User data

Conversely to diagnostic data, user data is data which refers to the process being monitored or controlled. In the case of this encoder, this data takes the form of the position and where applicable the speed which the Profibus transmits to the control system (master), and in the other direction a preset value with which the encoder (slave) can be pre-set to a certain position value.

User data is exchanged in the Data_Exchange mode. The framework conditions for the exchange (e.g. encoder resolution, word length) are previously defined in the configuration.

The slave can also indicate the presence of a diagnosis event during data exchange. The master then requests diagnostic and status information by means of a diagnosis request.

In order to set a preset, the master transmits the preset value (depending on the configuration either 16 or 32 bit) to the slave (see "preset function").

In the "Data Exchange" status, the dual LED lights up continuously in green on the bus cover.

8.4. Preset function

The preset function is only available in the encoder's "Class2" operating mode.

The control system can transmit a preset value to the encoder and so set the encoder, given a prescribed mechanical position, to a certain position value. The preset value must lie within the programmed overall measurement range.

To ensure optimum coordination between the mechanical position and the preset value, the preset value should only be set when the encoder is at a standstill. However, where the requirements are not particularly stringent, this can also be performed during rotary movement.

In order to set a preset, the control system transmits the preset value twice to the encoder: Once with the most significant bit (MSB) set and then again with the MSB reset. In this way, the MSB acts in a certain manner as a "clock" bit. For this reason, the transmitted preset value is limited to the value range up to 15 bit (encoder class 2, 16 bit) or 31 bit (encoder class 2, 32 bit).

The first transmission is authoritative in determining the time of acceptance.

Example: Zeroing the encoder (preset value = 0, encoder class 2, 32 bit)

Step 1: Control transmits 80000000h (preset adoption)

Step 2: Control transmits 00000000h (control bit return)

The encoder calculates an offset value for internal purposes from the differential between the current position and preset value. This value generally has no bearing on the application, but can be read out if required among the diagnostic data.

The offset value is stored on a non-volatile basis in an EEPROM chip. The EEPROM is capable of at least 1 million write cycles. However, despite the high number of possible write cycles, frequent program or event-controlled preset setting could mean reaching the service life limit. A certain degree of care is therefore called for when designing the control software at this point.

9. Entering parameters

The following parameter data is stored in the GSD file in the form of 32-bit values (double words, format "unsigned32"):

- Steps per revolution
- Total resolution

Many configuration programs for Profibus masters (including also Step7® from SIEMENS) do not support this word length during parameter input. The upper and lower 16 bits of these parameters ("hi" and "lo" block) must accordingly be entered separately, and in decimal form.

In the case of parameters smaller than 65535 (16 bit), all that is necessary is to enter the block "hi" = 0 and the parameter itself is entered directly in the "lo" block.

Parameters greater than 65535 (16 bit), must be separated beforehand using the formula described below and then recalculated. A calculator with hexadecimal function of the type provided among the "Windows accessories" is helpful here.

- Conversion of the required parameter value from the decimal format into hexadecimal format
- Subdivision of the hexadecimal value into two blocks, "hi" and "lo". The block length in each case is two words
- Conversion of the hexadecimal format of the two blocks "hi" and "lo" back into decimal format
- Input into the input mask using the decimal format

Example

Total resolution	= 3600 steps per revolution x 256 revolutions	= 921600
Conversion into hexadecimal format		= E1000
Subdivision into "hi"		= 000E
Conversion into decimal format		= 14
Subdivision into "lo"		= 1000
Conversion into decimal format		= 4096
Total measuring range (units) hi		= 14
Total measuring range (units) lo		= 4096
Steps per revolution	= 3600 steps	= 3600
Measuring units per rev. hi		= 0
Measuring units per rev. lo		= 3600



Example for entering parameters

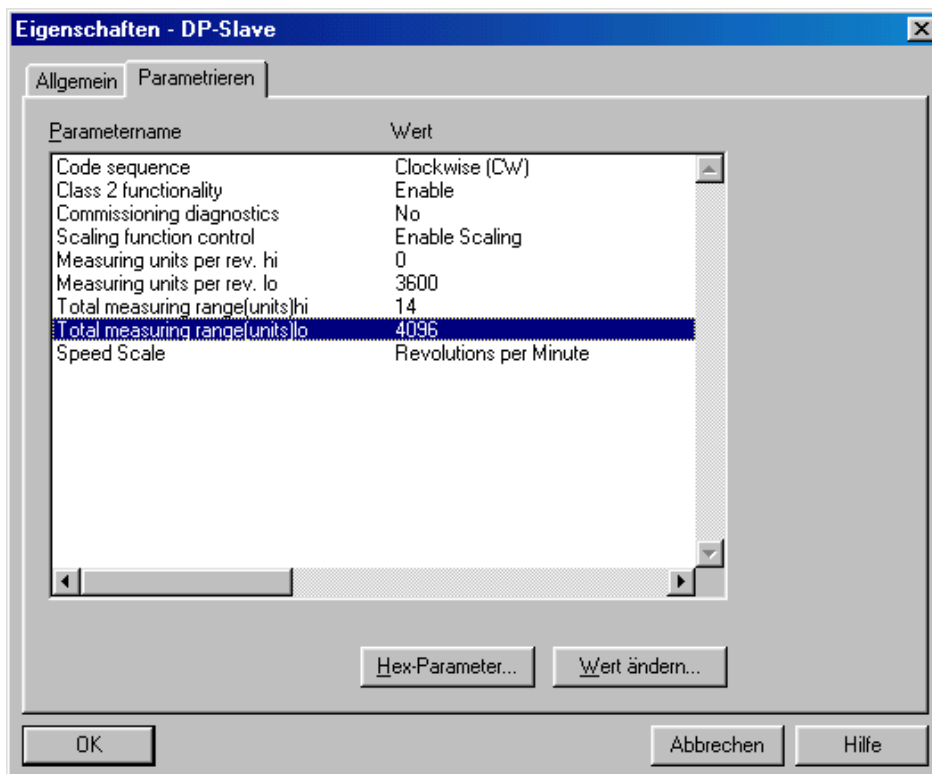

10. Terminal assignment and commissioning

10.1. Mechanical mounting

Shaft encoder

- Mount the encoder housing using the fastening holes on the flange side with three screws (square flange with four screws), paying attention to the thread diameter and thread depth.
- Alternatively, the encoder can be mounted in any angular position using three eccentric fastenings - see accessories.
- Connect the drive shaft and encoder shaft using a suitable coupling. The ends of the shafts must not be touching. The coupling must be capable of compensating for displacement due to temperature and mechanical backlash. Pay attention to the admissible axial or radial shaft loads. For suitable connecting devices, see under accessories.
- Tighten the fastening screws

End shaft / Hollow shaft encoder

- Clamping ring fixture
Prior to mounting the encoder open the clamping ring completely. Push encoder onto the drive shaft and tighten the clamping ring firmly.
- Encoder torque pin
Slide encoder onto the drive shaft and insert torque pin into the adjusting element provided by customer.
- Adjusting element with rubberized spring element
Push the encoder on to the drive shaft and insert the parallel pin into the mounted adjusting element (not supplied) (with rubberized spring element)
- Adjusting bracket
Push the encoder over the drive shaft. Insert the adjusting bracket into the rubberized spring element of the encoder and fasten the adjusting bracket on the contact surface (not supplied).
- Shoulder screw
Push the encoder over the drive shaft and insert the shoulder screw (not supplied) in the rubberized spring element of the encoder.
- Coupling spring
Mount the coupling spring with screws onto the fixing holes of the encoder housing.
Push the encoder over the drive shaft and fasten the coupling spring on the contact surface.

10.2. Electrical connection

Only ever store or transport the bus cover in the ESD bag. The bus cover must rest fully against the housing and be firmly screwed in place.

For electrical connection, pull off the bus cover using the following method:

- Release the fastening screws of the bus cover
- Carefully loosen the bus cover and lift off in the axial direction

10.2.1. Setting the user address

The user address is set decimally using two rotary switches in the bus cover.

The maximum number of users is 99. The address is read in once during power-up.

- Set the user address decimally using the two rotary switches 1 and 2 (default setting 00).

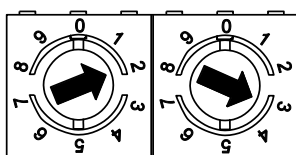

Example: 23

10.2.2. Terminating resistor

If the connected encoder is the last one in the bus line, the bus must be terminated with a resistor. The resistors are integrated in the bus cover and are connected using a two-pole DIP switch.

- The internal terminating resistors must be set to "ON" in the last user with the two-pole DIP switch (default setting OFF).

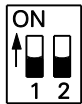

both ON = Final user
both OFF = user X

Terminal	Resistor
A to GND	390 Ohm
B to +5 V	390 Ohm
A to B	220 Ohm

10.2.3. Bus cover connection

- Release the cap nut of the cable gland.
- Push the cap nut and seal insert with contact sleeve onto the cable sheath.
- Strip the cable sheath and cores, shorten the shield film where this exists (see Fig.)
- Bend over the braided screen by approx. 90°.
- Push the sealing insert with contact sleeve along as far as the braided shield. Insert the sealing insert with contact sleeve and cable flush into the cable gland and tighten the cap nut.

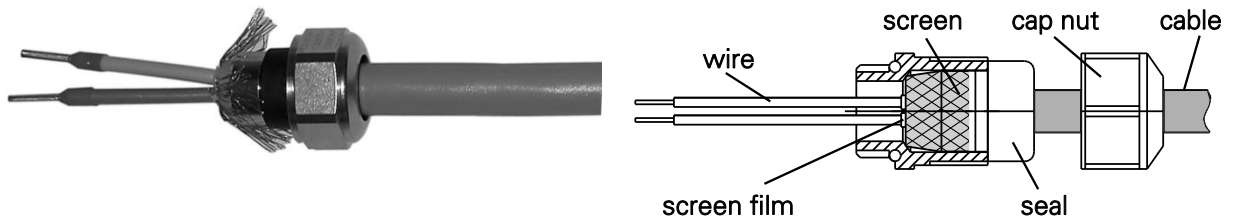

For standard encoder

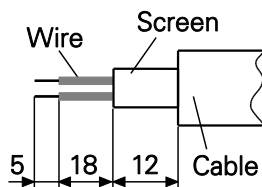

For G0AMH, G0MMH, GBAMH and GBMMH

Bus cable

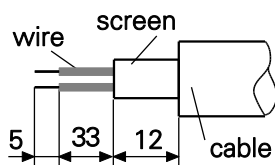

Supply voltage cable

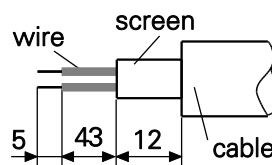

- Terminals with the same designation are internally interconnected.
- For the power supply, use only cable gland 3. For the bus lines, cable gland 1 or 2 can be optionally selected. For the bus lines, cable glands 1 or 2 can be freely selected. Observe the admissible cable cross sections.
- Insert the cores using the shortest route from the cable gland to the terminal strip. Observe the admissible core cross-section. Use isolated core end sleeves.
- Avoid crossing over data lines with the supply voltage line.

Bus cover – shaft/end shaft

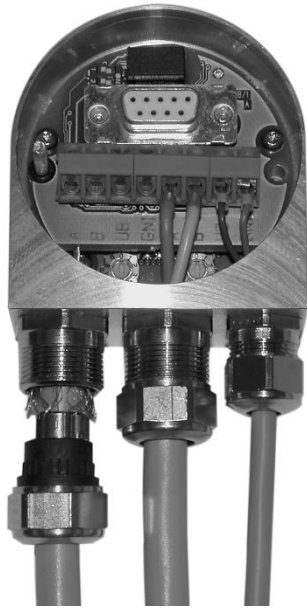

1 2 3

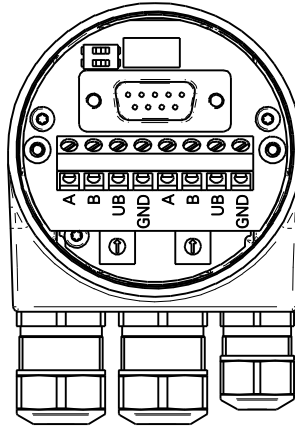

Cable gland

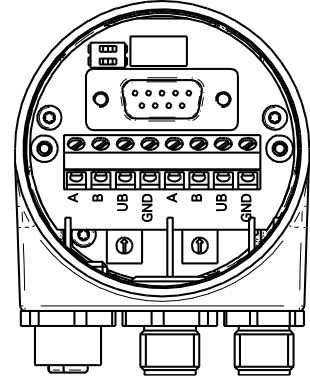

M12-connector

Bus cover – hollow shaft G1 and G2



1 2 3

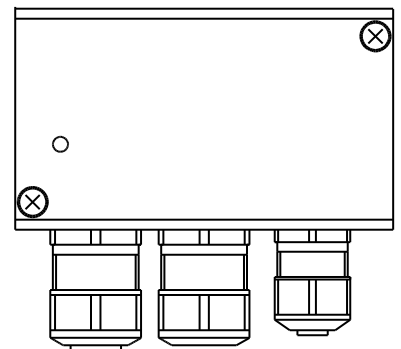
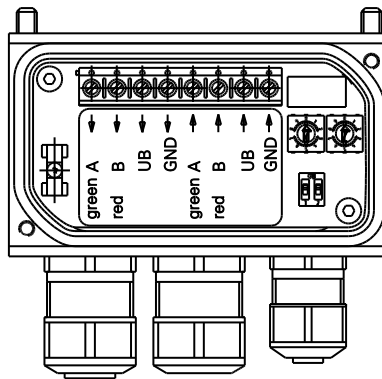

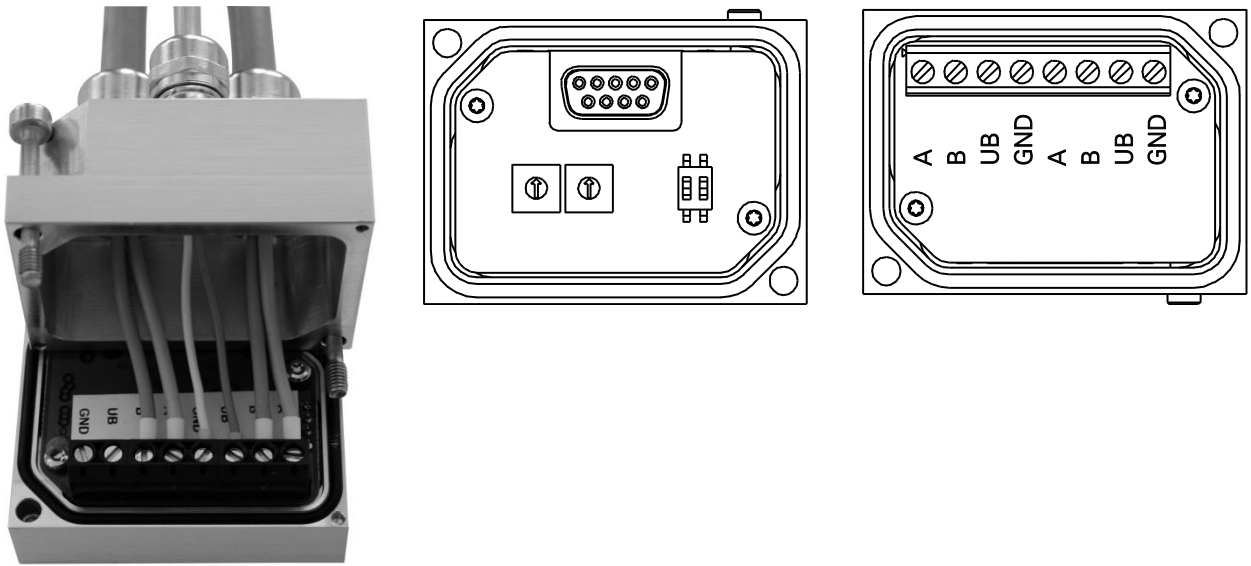
Bus cover – hollow shaft G0 and GB

Interface converter - GK410

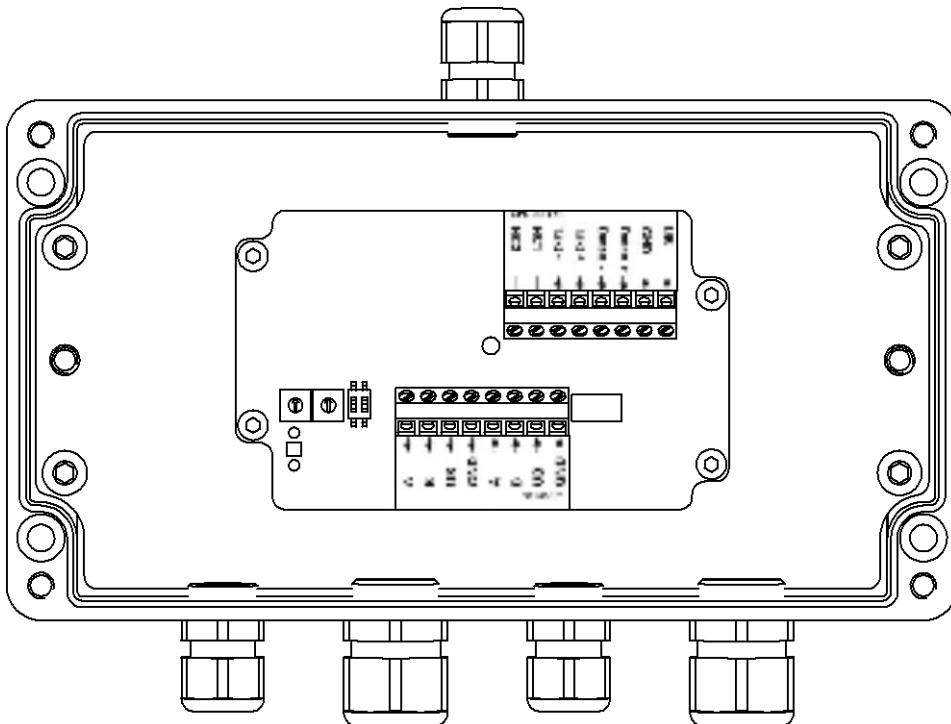
- The connection cable is wired to the 8-pin terminal block inside the interface converter.
- The additional functions Zero and UP/DOWN provided by the encoder are to be assigned as follows for optimum interference immunity:
 - Zero additionally assigned to GND
 - UP/DOWN additionally assigned to UB
- The encoder outputs DV, DV-MT may either be cut off and isolated or assigned to the available terminals NC1(DV) respectively NC2 (DV-MT).



10.2.4. Terminal assignment

Pin	Terminal	Explanation
Pin 1	UB	Supply voltage 10...30 VDC
Pin 3	GND	Ground connection relating to UB
Pin 2	A	Negative serial data line
Pin 4	B	Positive serial data line

M12-connector

For serial data line

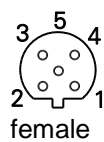
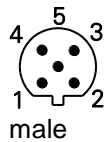

for supply voltage

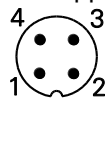

Terminals with the same significance are internally connected and identical in their functions. Max. load on the internal terminal connections UB-UB and GND-GND is 1 A.

A and B are each isolated for 12 MBaud operation with an inductivity of 100 nH

- Carefully plug the bus cover onto the D-SUB plug of the basic encoder, then press only via the sealing rubber, taking care not to tilt it. The bus cover must rest fully against the basic encoder.
- Tighten both the fastening screws firmly in the same direction.

The encoder housing and braided shield of the connecting cable are only ideally connected if the bus cover is resting fully on the basic encoder (positive locking).

10.3. Display element (status display)

A dual LED is integrated at the back of the bus cover.

Colour	Status
Green alight	Encoder in "Data_Exchange" mode
Yellow alight	Encoder ramping up
Red alight for 2.5 s	Wrong position value, caused by code constancy error
Red flashing, 1 Hz	Parameterization error
Red flashing, 5 Hz	Transmitted preset value in inadmissible value range

10.3.1. Profibus cable

EN 50170 specifies two types of cable, A and B. Cable type B is obsolete and should no longer be used for new applications. With cable type A, all transmission rates up to 12 MBaud can be used.

Features	Data
Shaft resistance in Ohm	135 to 165 at 3 to 20 MHz
Operating capacity (pF/m)	Less than 30
Loop resistance (Ohm/km)	Less than 110
Core diameter (mm)	Greater than 0.64
Core cross section (mm)	Greater than 0.34

Transmission speed depending on cable length

Baud rate in kBaud	9.6	19.2	93.75	187.5	500	1500	3000	12000	
Cable length in m	1200	1200	1200	1000	400	200	100	100	