

Manual

Encoder Programming Software ProGeber 1.4

Content

1	Introduction	4
1.1	Product assignment	4
2	General information	5
2.1	System requirements	5
2.2	Installation	5
2.3	Software state	5
2.4	Notes for operation	6
3	The program ProGeber	7
3.1	Basic information	7
3.2	Program run	7
3.2.1	Select encoder	8
3.2.2	Encoder connected to PC "Automatic choose"	9
3.2.3	Select type of encoder from table "Manual choose"	10
3.2.4	Start programming of encoder	11
4	Program encoder	13
4.1	Menu bar	13
4.1.1	File	13
4.1.2	Settings	14
4.1.3	Extras	15
4.1.4	Info	16
4.1.5	Reprogramming	16
4.1.6	Load programming	16
4.1.7	Save programming	16
4.1.8	Print	16
4.1.9	Load encoder data	16
4.1.10	Save data in encoder	16
4.1.11	Display the position	16
4.2	Explanation of programming mask „resolution“	17
4.2.1	Code (steps)	18
4.2.2	Code (Revolutions)	18
4.2.3	Code format	18
4.2.4	Counting direction	19
4.2.5	Preset (offset)	19
4.2.6	Revolutions	19
4.2.7	Steps / revolution	19
4.2.8	Entire resolution	20
4.2.9	Back to main menu	20
4.2.10	Dialog window	20
4.2.11	Display type of encoder	20
4.2.12	Read encoder data	21
4.2.13	Send encoder data	21
4.3	Explanation of programming mask „outputs“ for parallel encoders	22
4.3.1	Special outputs	23
4.3.2	Least significant bit (LSB) revolutions	23
4.3.3	Domain „special outputs“	23

4.3.4	Output logic	24
4.3.5	Steps	24
4.3.6	Revolution	24
4.3.7	Entire resolution	24
4.4	Explanation of programming mask „outputs“ for SSI encoders	25
4.4.1	Output format	26
4.4.2	Special bits SSI	27
4.4.3	Number of data bits	27
4.4.4	Assigned outputs	27
4.4.5	Domain special outputs	27
4.4.6	Output logic	28
4.4.7	Monoflop time	28
4.5	Explanation of mask „Position display“	29
4.6	Explanation „Set position“	30
4.7	Explanation „Teach In“	31
4.8	Explanation cam switching mechanism	34
5	Wiring the encoders	35
5.1	Wiring between PC and encoder	35
5.1.1	Contact parallel encoder	35
5.1.2	Contact SSI encoder	37
5.1.3	Contact SSI bus cover	38
6	Appendix	39
6.1	Description of parallel encoder	39
6.2	Description of SSI encoder	40

1 Introduction

1.1 Product assignment

Shaft encoder

Product	Product family	Interface
GBAMW	Singleturn SSI bus cover	RS232
GBLMW	Multiturn SSI bus cover	RS232
GBMMW	Multiturn SSI bus cover	RS232
GCAMW	Singleturn SSI bus cover	RS232
GCMMW	Multiturn SSI bus cover	RS232
GXAMW	Singleturn SSI bus cover	RS232
GXMMW	Multiturn SSI bus cover	RS232
GXP1W	Parallel	RS232
GXP2W	SSI	RS232
GXN1W	Cam encoder	RS232

Blind hollow shaft encoder

Product	Product family	Interface
GBAMS	Singleturn SSI bus cover	RS232
GBLMS	Multiturn SSI bus cover	RS232
GBMMS	Multiturn SSI bus cover	RS232
GCAMS	Singleturn SSI bus cover	RS232
GCMMS	Multiturn SSI bus cover	RS232
GXAMS	Singleturn SSI bus cover	RS232
GXLMS	Multiturn SSI bus cover	RS232
GXMMS	Multiturn SSI bus cover	RS232

Through hollow shaft encoder

Product	Product family	Interface
G1AMH	Singleturn SSI bus cover	RS232
G2AMH	Singleturn SSI bus cover	RS232
G1MMH	Multiturn SSI bus cover	RS232
G2MMH	Multiturn SSI bus cover	RS232
GXP1H	Parallel	RS232
G1P2H	SSI	RS232 or RS485
GXP2H	SSI	RS232 or RS485
GXN1H	Cam encoder	RS232

2 General information

2.1 System requirements

A PC with operating system Windows 95/98/2000/XP/NT or Windows 7.

2.2 Installation

The installation of ProGeber depends on the programming interface of the encoder. Both variations of RS232 and RS485 are filed on the CD-ROM under separate directories.

Encoder with RS232 interface (Windows 95/98/2000/XP/NT/Win7):

For operation systems Windows 95/98/2000/XP/NT, encoder choice menu, please refer to chapter "Introduction":

How to start ProGeber Software „setup_ProGeber.exe“ out of directory „RS232 interface“.

Encoder with RS485 interface (Windows 95/98/NT):

For operation systems 95/98/NT, encoder choice menu, please refer to chapter "Introduction":

Installation of serial driver out of directory „RS485 interface“ by starting file „setup_Ser_Driver.exe“, followed by starting the ProGeber Software file „setup_ProGeber_KiS.exe“. Finally the computer must boot up anew for integration of the serial driver into the operation system.

Encoder with RS485 interface (Windows 2000):

For operation system Windows 2000, encoder choice menu please refer to chapter "Introduction":

Installation of the serial driver out of the directory „RS485 Interface Win2k“ by starting file „setup_Ser_Driver_Win2k.exe“, followed by starting the ProGeber Software file „setup_ProGeber_KiS.exe“. Finally the computer must boot up anew for integration of the serial driver into the operation system.

The installation is menu-driven.

Note: Under Windows NT/XP/2000 and Win7 the installation can only be executed with administrator rights.

2.3 Software state

ProGeber version 1.4 is replacing former ProGeber versions.

2.4 Notes for operation



- Any wiring on encoder plug or control desk is to be effected in powerless state only. The encoder plug must not be plugged in or out whilst under voltage.
- Please check and plug all plug-in connections before switching on.
- **Caution!**
Incorrect encoder programming may lead to breakdown of the system.

Product information

The information in this publication is subject to change without prior notice.

Baumer Germany GmbH & Co. KG does not give any warranty of specified quality or functionality with respect to the information contained in this publication. Baumer Germany GmbH & Co. KG assumes no responsibility or liability for any errors or inaccuracies that may appear in this manual.

3 The program ProGeber

3.1 Basic information

The program ProGeber is a software for programming Baumer encoders. It enables the reading out, the modification and the display of encoder data. Hereby the encoder parameters can be read out, altered, programmed and displayed. To make the programming as easy as possible, the user can select valid fields only. Fields that cannot be selected are highlighted in grey. Before the encoder can be programmed, the type of encoder must be selected. Thus a logical program run is achieved after starting the program:

1. Step Select language via the respective country's flag
2. Step Select type of encoder by clicking the button "Select encoder"
3. Step Programming can be started

If your encoder cannot be detected automatically and is not included in the selection menu as well, please contact Baumer Germany GmbH & Co. KG.

3.2 Program run

After the **opening image** the following mask will appear:

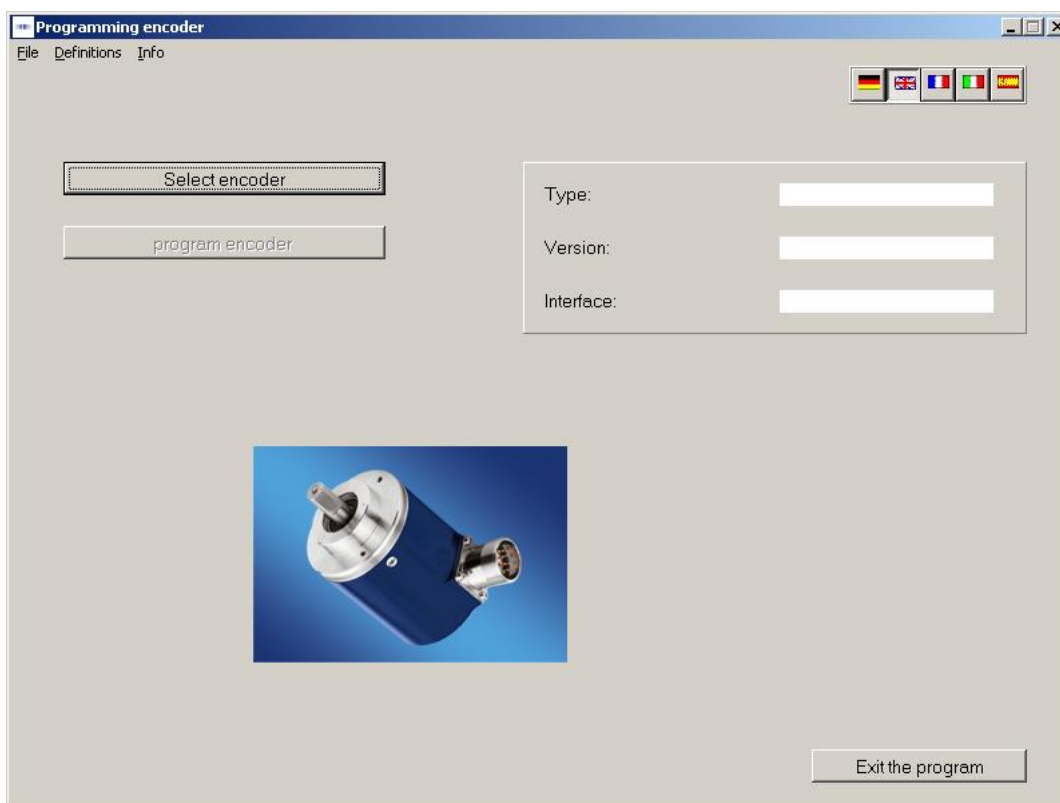

The programming can only be started after selecting a type of encoder. The selection of the encoders is described in the chapters „Encoder connected to PC ⇒ Automatic selection" and „Select type of encoder from table ⇒ Manual selection".

3.2.1 Select encoder

First step is selection of the encoder.

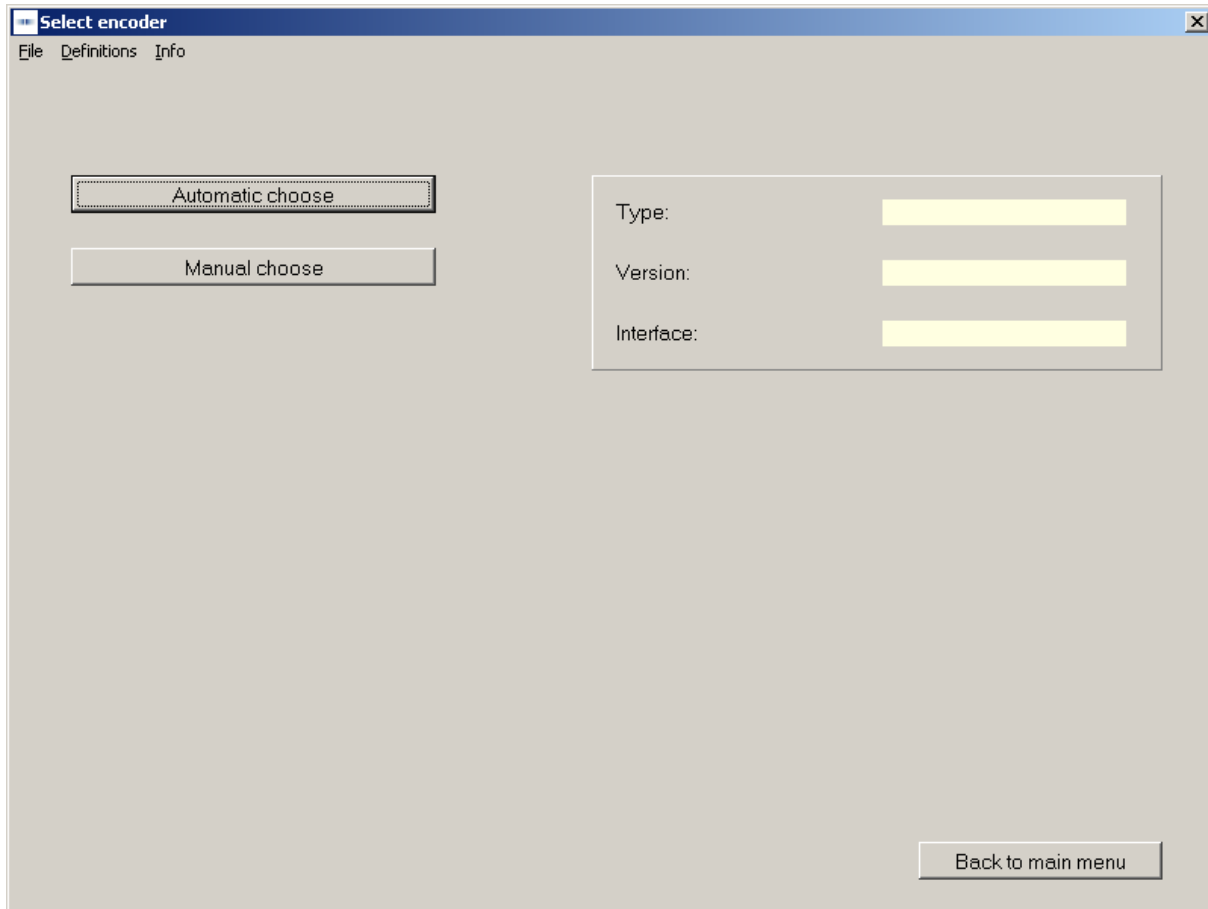

By the software an optional automatic selection is offered, provided the encoder is connected to the interface. In case of lacking encoder connection, the desired encoder model can be selected from the list.

3.2.2 Encoder connected to PC "Automatic choose"

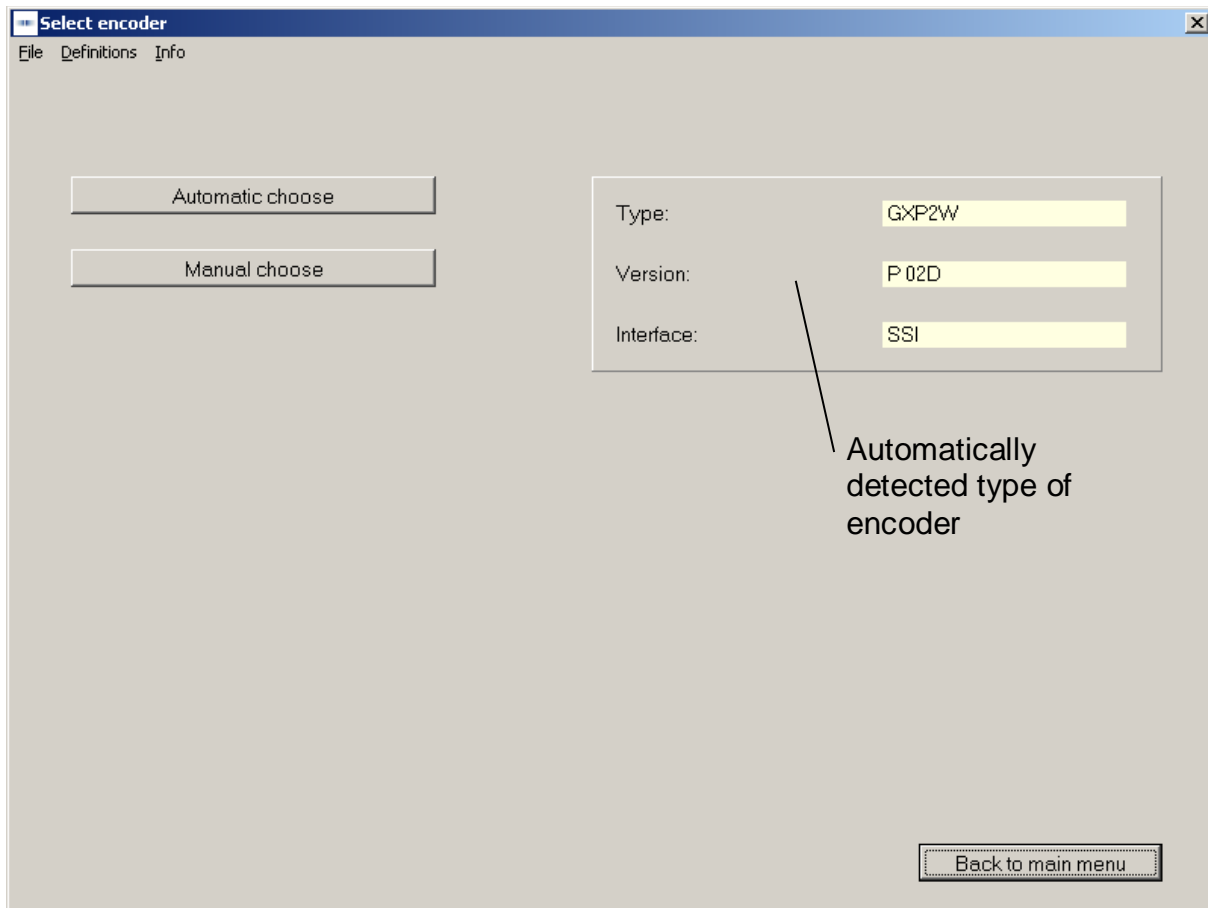

The type of encoder can be read out when the encoder is connected (automatic). This data is necessary to provide the relevant parameters for programming. If no encoder is connected or if the cable connection is not connected properly, an error message will be displayed. If the automatically detected encoder does not correspond with the encoder's type label, please contact Baumer Germany GmbH & Co. KG.

3.2.3 Select type of encoder from table "Manual choose"

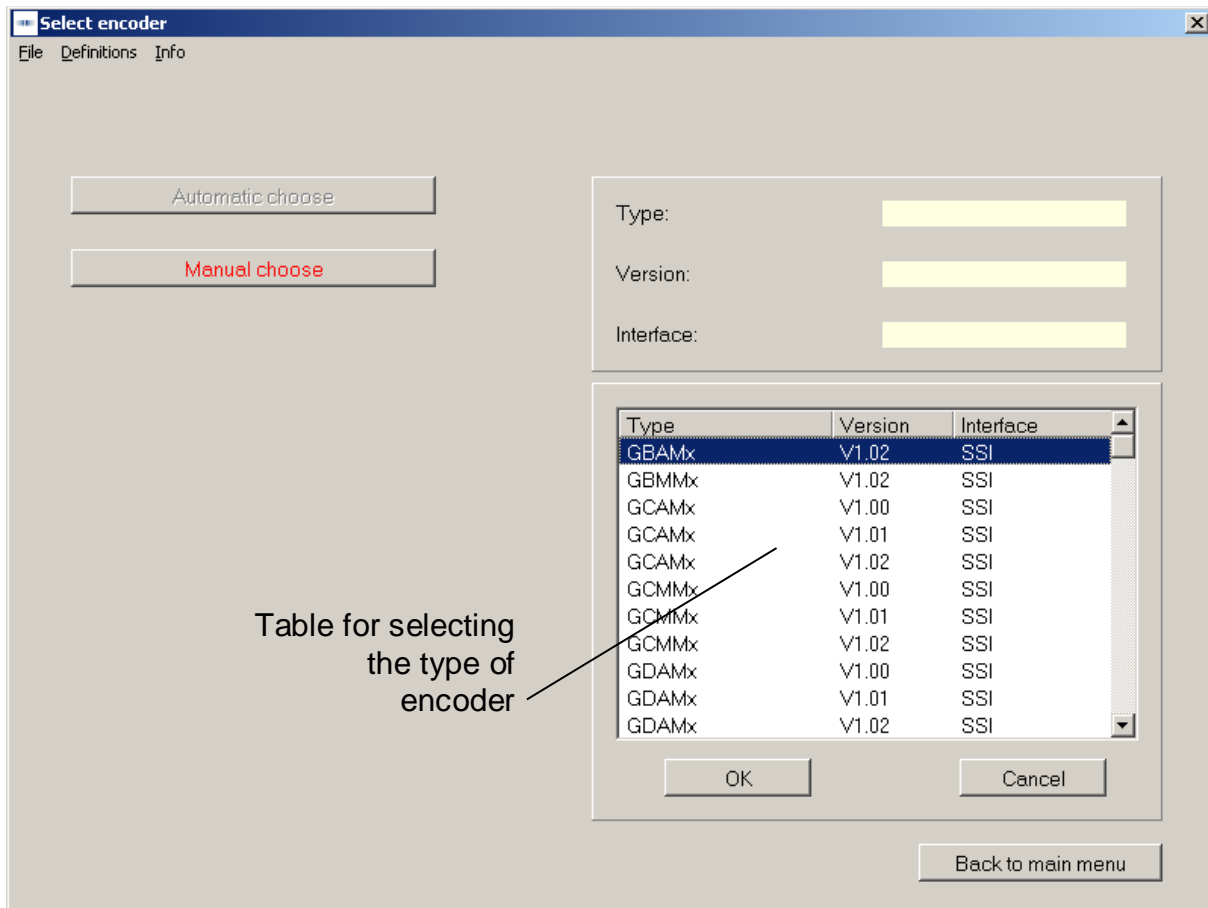

If no encoder is connected to the PC, the type of encoder can be selected from a table (manual selection). The table contains the common types. It is not only the type that is important but also the version. If your type should not be included, please contact Baumer Germany GmbH & Co. KG. Type and version can be found on the type label of the encoder.

3.2.4 Start programming of encoder

After successfully selecting the encoder, you can start programming. The button "program encoder" is now active. The selected encoder is once again displayed in the right mask.

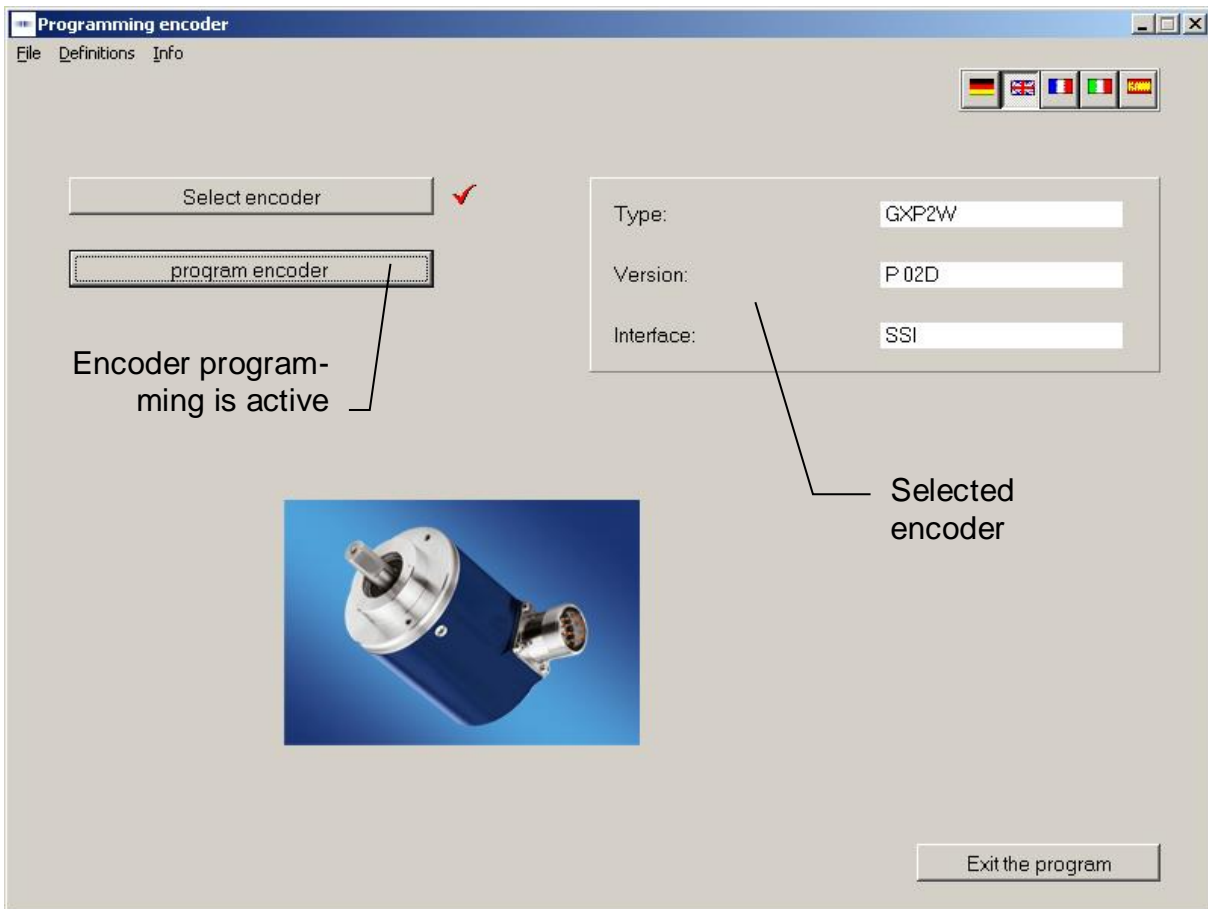

The programming mask now enables the programming of all parameters that are possible for the respective encoder.



The mask may vary according to the corresponding encoder model

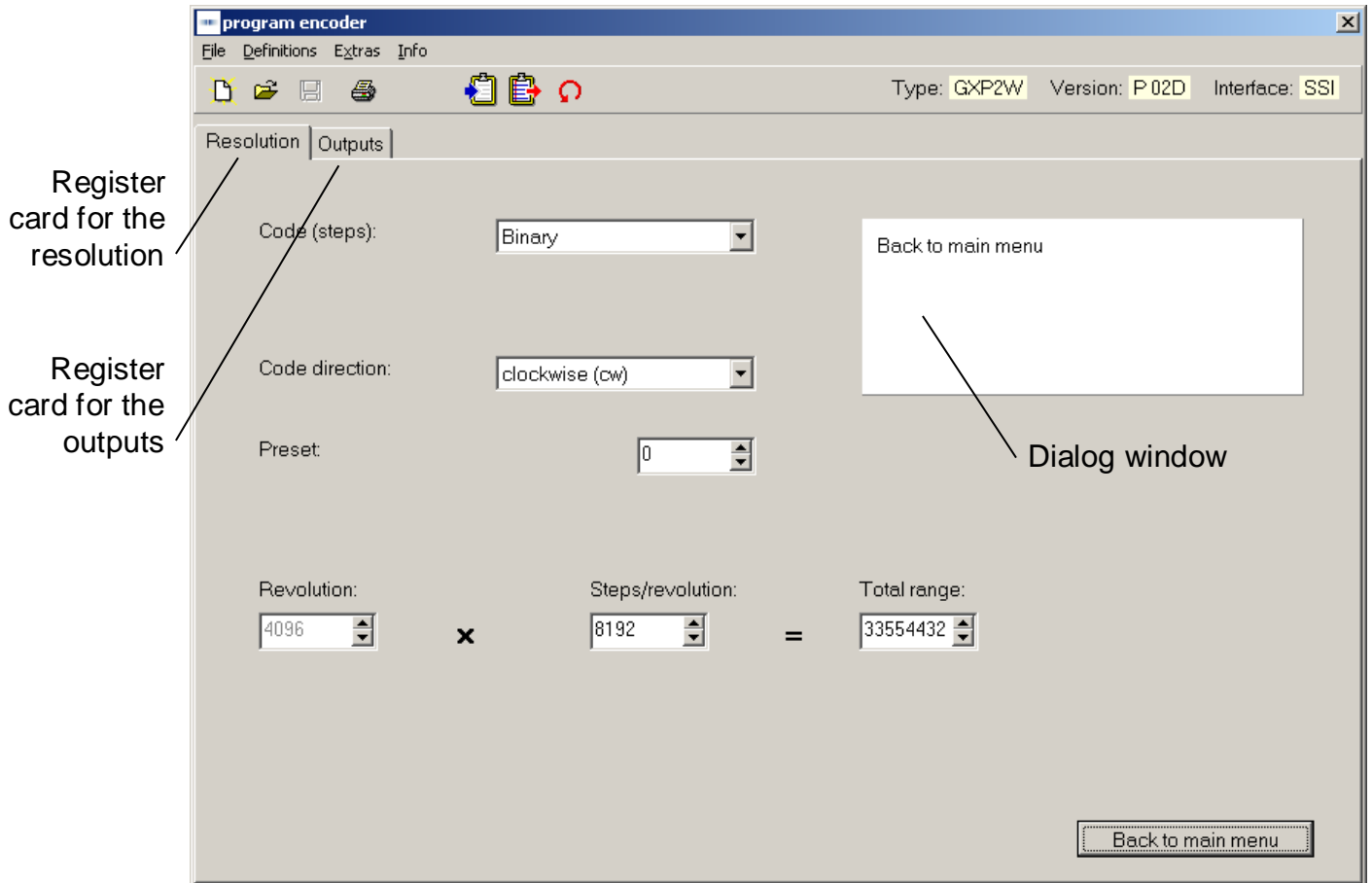

The parameters for the encoder can be set by means of the register cards for the resolution and the outputs. The dialog window gives additional support, or that is to say explains the window that has just been selected.

See chapter 4.2 for register cards „Resolution“.

The explanation for the register cards „Outputs for Parallel Encoders“ see chapter 4.3 and „Outputs for SSI Encoders“ see chapter 4.4.

4 Program encoder

4.1 Menu bar

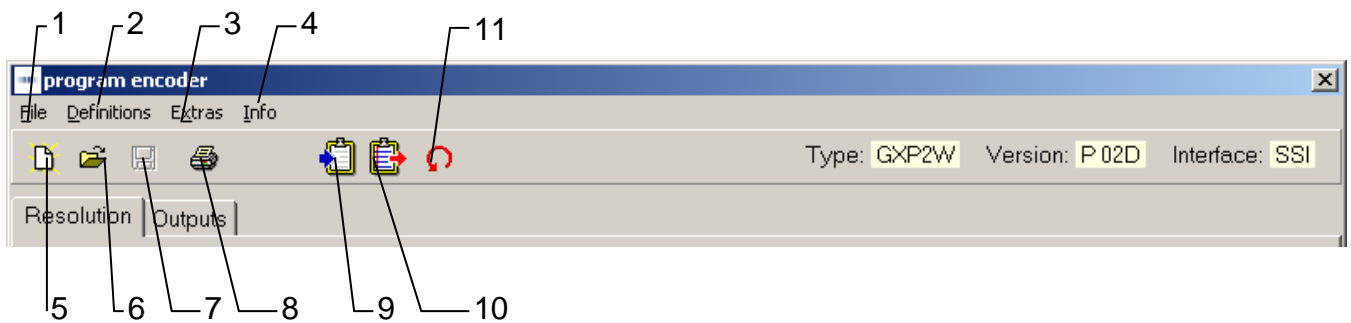

N°	Chapter	Button
1	4.1.1	File
2	4.1.2	Settings
3	4.1.3	Extras
4	4.1.4	Info
5	4.1.5	Reprogramming
6	4.1.6	Load programming

N°	Chapter	Button
7	4.1.7	Save programming
8	4.1.8	Print
9	4.1.9	Load encoder data
10	4.1.10	Save data in encoder
11	4.1.11	Display the position

4.1.1 File

The following menu items can be selected in the "File" menu:

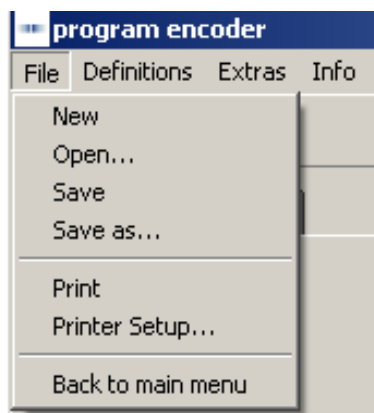

- New: A programming mask with basic setting is loaded.
- Open: A saved program can be loaded.
- Save: The current data can be saved.
- Save as: The current data can be saved with a name of your choice in a directory of your choice.
- Print: The current data can be printed for archiving.
- Select printer: A printer can be chosen.
- Back to main menu: The programming mask is closed.

4.1.2 Settings

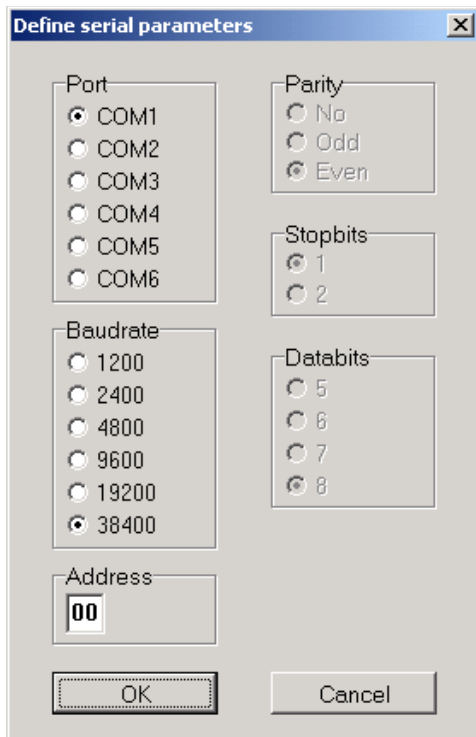

Click "settings" menu to select the serial interface COM 1 up to COM 6 to which the encoder is connected. Furthermore, you can adjust the baud rate and the address of the encoder. The other parameters such as parity, stop bits and data bits can be controlled here.

4.1.3 Extras

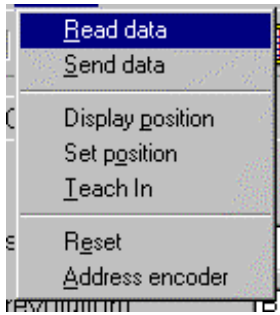

Call up data:	The data is called up from the connected encoder
Send data:	The current programming is saved in the encoder
Display position:	The display mask is opened (see chapter 4.5 „position display“)
Set position:	The mask for assignment of any value desired is being opened. (see chapter 4.6 Explanation „Set position“)
Teach in:	The mask for the automatic scaling is displayed (see chapter 4.7 „Explanation Teach in“)
Reset:	The encoder is programmed to basic setting Caution: Old encoder data will be overwritten!
Address encoder:	The address set at the connected encoder is called up or set.



The mask may vary according to the corresponding encoder model

4.1.4 Info

Click "Info" menu to display the current software version of the ProGeber software and of the encoder software.

4.1.5 Reprogramming

The display mask is reset to the basic setting.

The same function can also be released by „File ⇒ New“.



4.1.6 Load programming

A programming saved in the PC can be loaded.

The same function can also be released by „File ⇒ Open“.



4.1.7 Save programming

The current data is saved in the PC.

The same function can also be released by „File ⇒ Save“.



4.1.8 Print

The current encoder data is printed. The printout can be used for archiving.

The same function can also be released by „File ⇒ Print“.



4.1.9 Load encoder data

The data from the connected encoder is called up.

The same function can also be released by „Extras ⇒ Call up data“.



4.1.10 Save data in encoder

The current programming is saved in the encoder.

The same function can also be released by „Extras ⇒ Send data“.



4.1.11 Display the position

The current position and the state of the special outputs are displayed.

The same function can also be released by „Extras ⇒ Display position“.



4.2 Explanation of programming mask „resolution“

The programming mask, with which the resolution of the encoder can be set, is explained in detail below. The mask below shows the maximum possible settings. It may look different according to the encoder model. Only parameters that are supported by the selected encoder are being offered.



The mask may vary according to the corresponding encoder model.

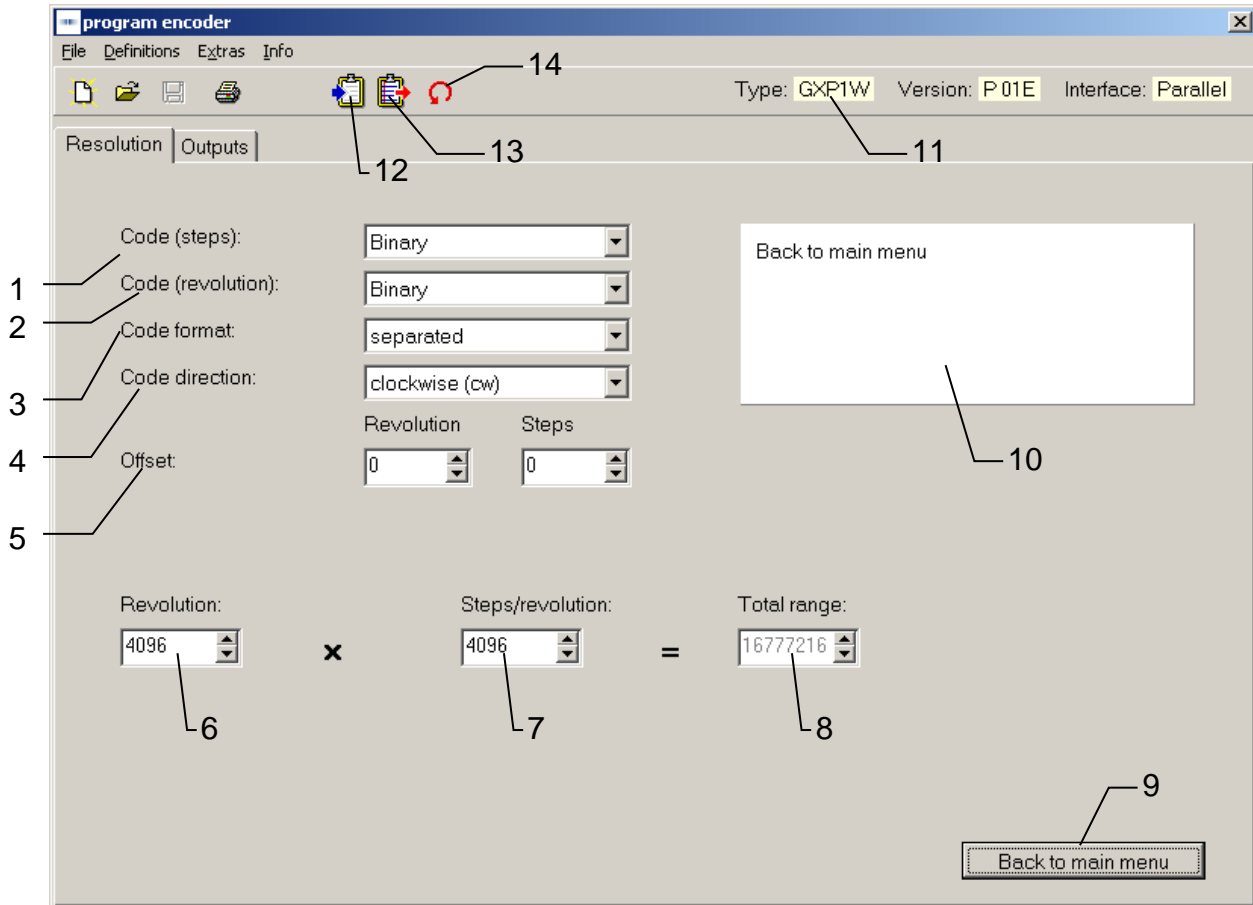

N°	Chapter	Field
1	4.2.1	Code (steps)
2	4.2.2	Code (revolution)
3	4.2.3	Code format
4	4.2.4	Counting direction
5	4.2.5	Offset or preset
6	4.2.6	Revolutions
7	4.2.7	Steps / revolution

N°	Chapter	Field
8	4.2.8	Entire resolution
9	4.2.9	Back to main menu
10	4.2.10	Dialog window
11	4.2.11	Display type of encoder
12	4.2.12	Read encoder data
13	4.2.13	Send encoder data
14	4.5	Position display

4.2.4 Counting direction

The counting direction offers two choices: "increasing clockwise" and "decreasing clockwise". "Increasing clockwise" means that the position values increase in case of a clockwise rotation (view from front of the encoder shaft), and decrease accordingly in case of "decreasing clockwise".

Caution: The counting direction can be inverted via the hardware input V/\bar{R} !
As far as the hardware is concerned, the counting direction must always be set first and afterwards the preset value (offset).

4.2.5 Preset (offset)

The encoder can be set to any start count required. Depending on the encoder model the start count can be defined as target (preset) or as difference between running value and target (offset).

Once programming is finalized, encoders set to „offset“ therefore are only adding the offset value to the current position value at first.

Even after completed programming the offset value can be assigned as well as preset value via the encoder's reset input by triggering a „high“ impulse for at least 100 ms.

4.2.6 Revolutions



Maximal number of turns to be counted by the encoder. The possible domain is between 1 and 65536 revolutions. According to the type of encoder, the domain is either optional or has to correspond to a power of two $2^0, 2^1, 2^2, \dots, 2^{16}$ (1, 2, 4, ... 65536, depends on the encoder).

4.2.7 Steps / revolution

Number of steps defining one turn of the encoder shaft. Depending on the encoder's interface, the possible range lies between 2 and 8192 steps/turn. Any value within this range can be selected. The maximum number of steps for encoders with parallel interface is 4096, with standard SSI interface 8192 (high resolution encoders 262144 at singleturn range).

4.2.8 Entire resolution

The entire resolution is the sum of steps / revolution multiplied by the number of revolutions. Thus, the domain depends on the setting of steps / revolution.

Formula of calculation for the entire resolution:

Revolutions X steps / revolution = entire resolution

Example: in case of 100 steps / revolution and a desired number of revolutions of 10, the entire resolution is 1000.

According to the type of encoder, either the number of revolutions or the entire resolution can be set. The other value is marked in grey and thus cannot be altered in any way. However, it is being calculated and displayed.

Info: This resolution may also be applied for movements where the zero point is being crossed several times in the same direction (continuous operation).

4.2.9 Back to main menu

Click the button "Back to main menu" to leave the programming mask. If some parameters have been modified, they can still be saved.

4.2.10 Dialog window

The dialog window contains info texts on the parameter that has just been selected. The info texts describe the respective parameter with short explanations.

4.2.11 Display type of encoder

The encoder chosen manually or automatically after the program start is permanently displayed in the programming mask. Thus, it can be checked whether the selected and the existing encoder are identical.

4.2.12 Read encoder data

The connected encoder is read out. Before the register card for „resolution“ and „outputs“ is overwritten, it can be saved. If the connected type of encoder is not identical with the selected one, the following error message will be displayed:

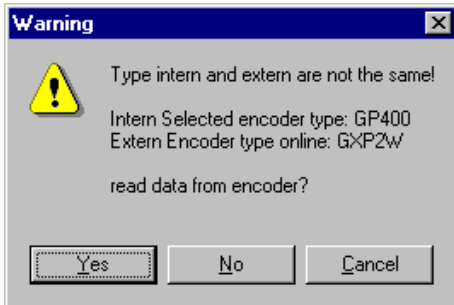

If the selected type of encoder and the connected one are identical, the data will be read in and displayed.

4.2.13 Send encoder data

The encoder connected to the interface is programmed with the set parameters. If the connected type of encoder and the selected one are not identical, the following error message will be displayed:

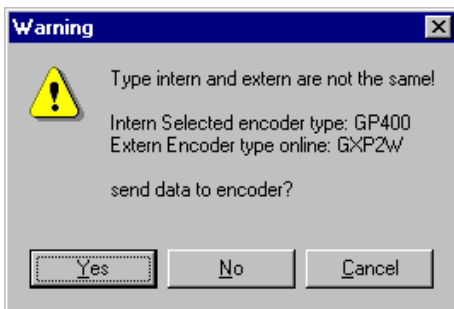

During the data transmission, the data is stored in the encoder while being protected against power failure. The transmission takes a few seconds and is displayed as follows:

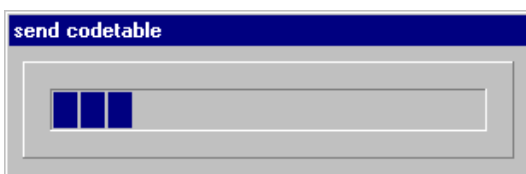

4.3 Explanation of programming mask „outputs“ for parallel encoders

The programming mask „outputs for parallel encoders“ is adapted to the connected encoder. Fields highlighted in grey cannot be changed for the selected type in question. The following mask shows a typical encoder with parallel output. The individual parameters are explained in detail below.

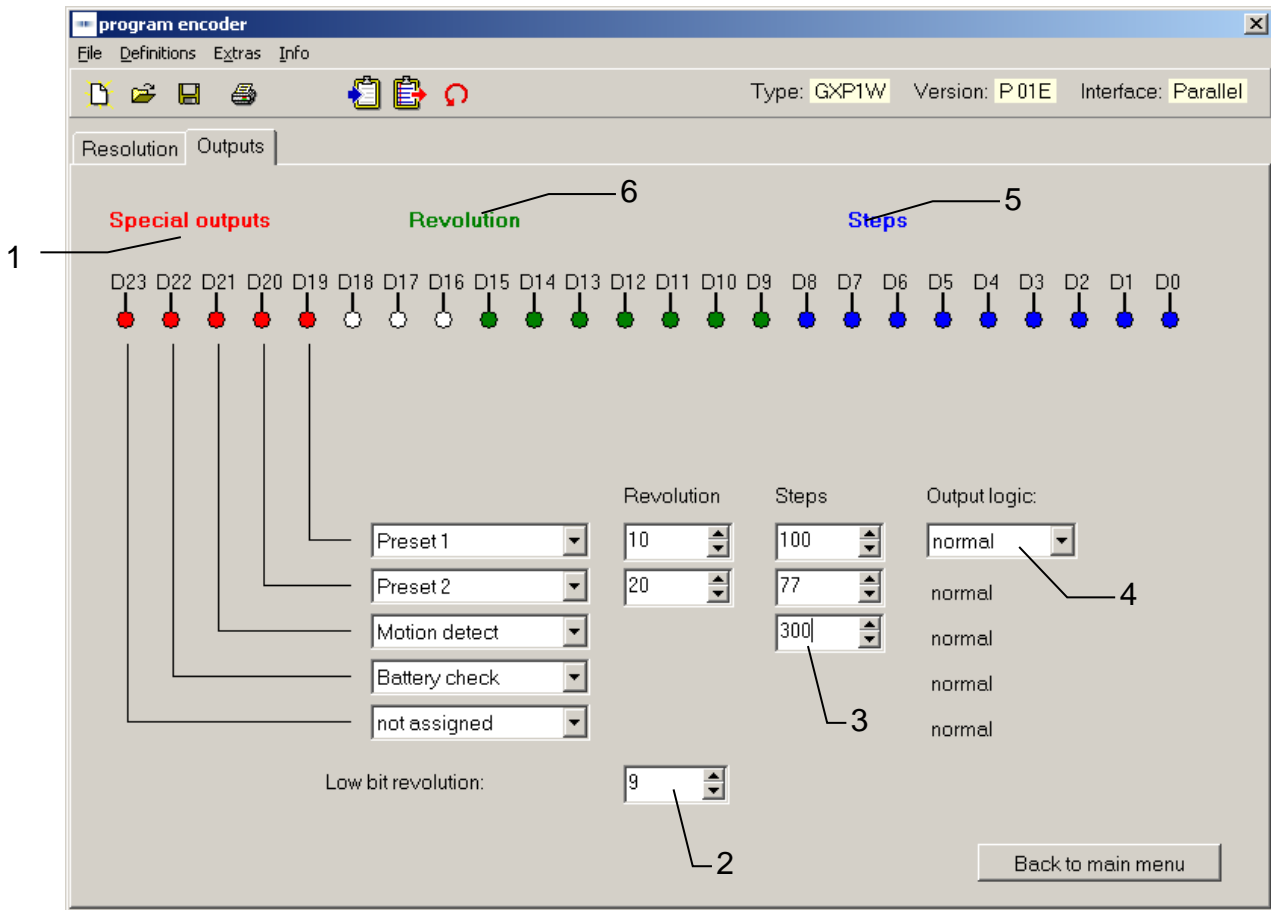

N°	Chapter	Field
1	4.3.1	Special outputs
2	4.3.2	Least significant bit revolutions
3	4.3.3	Domain special outputs
4	4.3.4	Output logic
5	4.3.5	Steps
6	4.3.6	Revolutions

4.3.1 Special outputs

The special outputs available are marked in red. Their number is depending on the total resolution selected as well as the code format. The outputs D19 to D23 allow a maximum assignment of 5 special outputs.

The outputs may be assigned in optional way to one of the following 6 functions, whilst the corresponding function selected can be assigned exclusively to one output.

- Preset 1: Output switches when the set value is exceeded.
- Preset 2: Output switches when the set value is exceeded.
- Speed monitoring: Output switches when the actual value falls below the set value. The value input in turns/minute.
- Battery control: Output triggers as soon as the voltage value for the lithium cell is falling below the critical point. However, the encoder function still remains secure for another three months.
- DataValid: Output switches when the checking of the code is faulty.
- DataValid + battery control: Both functions are assigned to the same output as a collective message

Open-circuited and closed-circuited can be changed via the function "output logic" (see chapter 4.4.6 Output logic).

4.3.2 Least significant bit (LSB) revolutions

The input field „least significant bit turns“ only appears if the resolution of steps/turn is inferior to the maximum resolution of 12 Bit thus indicating existing outputs not assigned. If so, the position of the turns within the range of D8 to D12 can be shifted to the position of output D8.

4.3.3 Domain „special outputs“

The domain „special outputs“ is used to select the desired position or rpm at which the special outputs are to switch. The domain can be displayed by moving the mouse to the input field.

4.3.4 Output logic

The function „output logic“ offers the choice between normal and inverted. In case of the normal output logic, a logical zero is in fact displayed as zero. If, in contrast, the output logic is inverted, a logical zero is displayed as 1.

Caution: The function "output logic", normal or inverted, refers to all 24 outputs.
Thus, the outputs for the position values are set as well.

4.3.5 Steps

The display for the steps (singleturn) shows the required outputs highlighted in blue. This display can be used to determine the corresponding outputs for the wiring.

Caution: The steps are only shown in case of a closed code, otherwise the entire resolution is displayed (see chapter 4.3.7 Entire resolution)

4.3.6 Revolution

The display for the revolution (multiturn) shows the required outputs highlighted in green. This display can be used to determine the corresponding outputs for the wiring.

Caution: The steps are only shown in case of a separated code, otherwise the entire resolution is displayed (see chapter 4.3.7 Entire resolution)

4.3.7 Entire resolution

If a closed code is set in the resolution, the entire resolution appears instead of "steps" (singleturn) or "revolutions" (multiturn). The entire resolution is displayed in blue and corresponds to the required outputs.

4.4 Explanation of programming mask „outputs“ for SSI encoders

The programming mask „outputs“ for SSI is adapted to the connected encoder. Fields highlighted in grey cannot be changed for the selected type in question. The following mask shows a typical encoder with SSI output. The different parameters are explained in detail below.



The following mask may vary according to the corresponding encoder model.

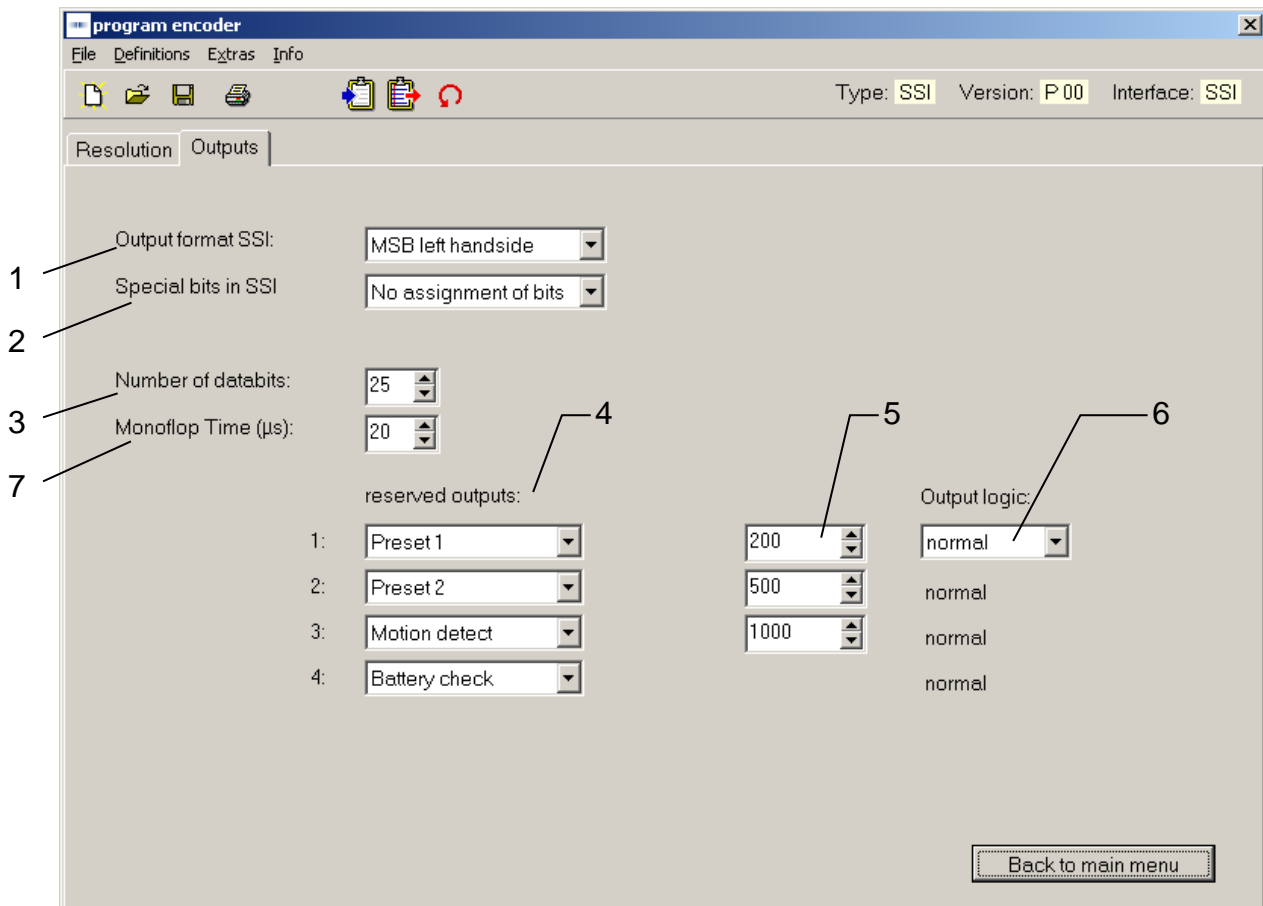

N°	Chapter	Field
1	4.4.1	Output format SSI
2	4.4.2	Special bits SSI
3	4.4.3	Number of data bits
4	4.4.4	Assigned special outputs
5	4.4.5	Domain special outputs
6	4.4.6	Output logic
7	4.4.7	Monoflop Time (µs)

4.4.1 Output format

The output format offers the choice between „left-justified“ and „tree“. In case of the „left-justified“ data format, the data is output starting with the revolutions. After the revolutions, zeros are sent up to the pulse space.

In case of the „tree“ the position values is always 25 bit. If the position value is smaller, the other digits will be padded with zeros.

Example for output format “tree” and „left-justified with zeros“:

Number of turns	Position value	Steps within on turn
4095	111111111111/111111111111	8191
511	000111111111/1111111111000	1023
127	000001111111/1111111000000	255
7	000000000111/1111000000000	15
1	000000000001/1100000000000	3

Example for output format „left-justified“:

Number of turns	Position value	Steps within on turn
4095	111111111111/111111111111	8191
511	11111111/1111111111000000	1023
127	111111/111111100000000000	255
7	111/1111000000000000000000	15
1	1/110000000000000000000000	3

4.4.2 Special bits SSI

In case of the „Special bits SSI“, the following special bits are added to the transmitted data bits:

- DataValid
- Parity

The added special bit „DataValid“ serves as an additional error control in the encoder and signalizes e.g. broken glass, LED failure, low supply voltage of electronically controlled gear box.

The easiest procedure for the detection of errors is to add a parity bit during the transmission. The parity of Baumer encoders is even. In case of even parity, the added parity bit is set to zero when the number of ones in the data word is even. It is set to one when the number is odd. Thus, the total number of transmitted ones in one data word including the parity bit is always even.

Note: When a parity bit is set, it is always the even one

4.4.3 Number of data bits

If the „Output format SSI“ is set left-justified, it is possible to send zeros ("high-order zeros") before the data bits. The number of data bits contains the data bits with the high-order zeros.

Example: In case of a 16-bit position value and a setting of 20 data bits, 4 high-order zeros are sent in front of the position value before the left-justified telegram is sent.

4.4.4 Assigned outputs

Besides the SSI interface several special outputs are available. The number of outputs depends on the encoder model, however it is limited to 4 maximum. The outputs may be assigned in optional way to one of the following 6 functions, whilst the corresponding function selected can be assigned exclusively to one output.

The outputs may be assigned to the following functions:

- Preset 1: Output triggers upon achieving the value entered.
- Preset 2: Output triggers upon achieving the value entered.
- RPM number control: Output triggers upon falling below the value entered.
Value input in turns/min.
- Battery control: Output triggers as soon as the voltage value for the lithium cell is falling below the critical point. However, the encoder function still remains secure for another three months.
- DataValid: Output triggers as soon as there is a code scanning failure.
- DataValid + battery control: Both functions are assigned to the same output as collective a message.

4.4.5 Domain special outputs

The domain „special outputs“ is used to select the desired position or rpm at which the special outputs are to switch.

4.4.6 Output logic

The function „output logic“ offers the choice between normal and inverted. In case of the normal output logic, a logical zero is in fact displayed as zero. If, in contrast, the output logic is inverted, a logical zero is displayed as 1.

Caution: The function „output logic“, normal or inverted, refers to all 4 special outputs.

4.4.7 Monoflop time

In this function the monoflop time can be set in the indicated values (only SSI bus cover).

4.5 Explanation of mask „Position display“

Click „Extras ⇒ Display position“ to select a display module displaying the positions and the special outputs.



After the start of the display module, the following mask appears (the mask can vary slightly according to the type of encoder and the programming).

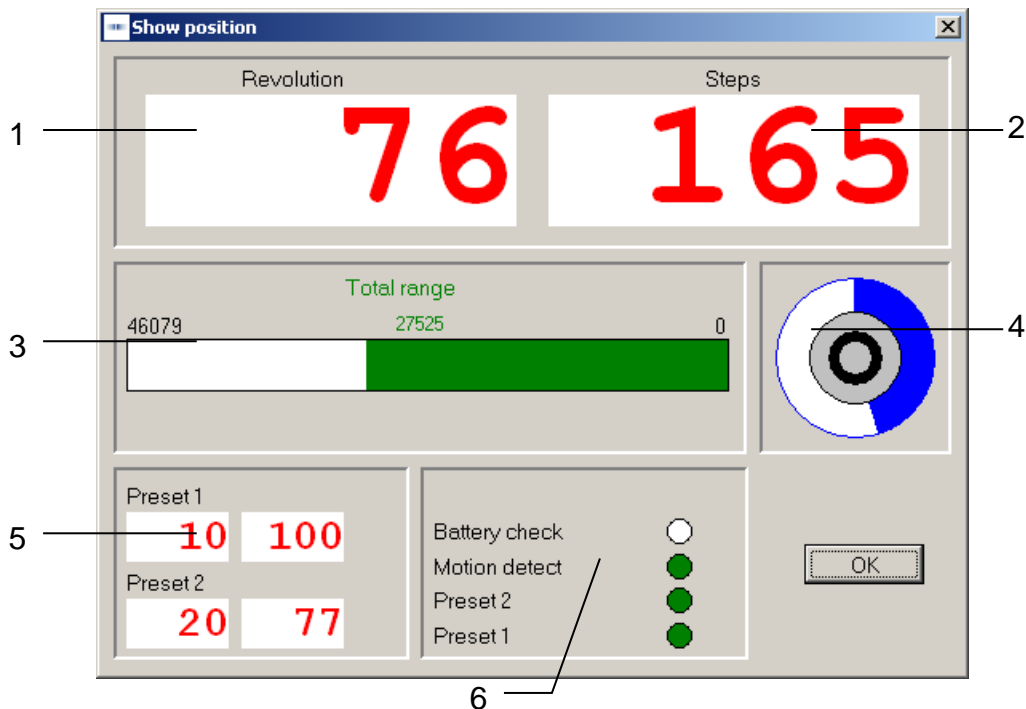

N°	Field
1	Position value revolutions
2	Position value steps
3	Bar display entire resolution
4	Display steps / revolution
5	Display field for the set preselections
6	Display field for the special outputs

4.6 Explanation „Set position“



After selection of menu „Set Position“ you will be given a message informing that the preset value is being reset to zero. This has to be confirmed by „OK“ (depends on the encoder).

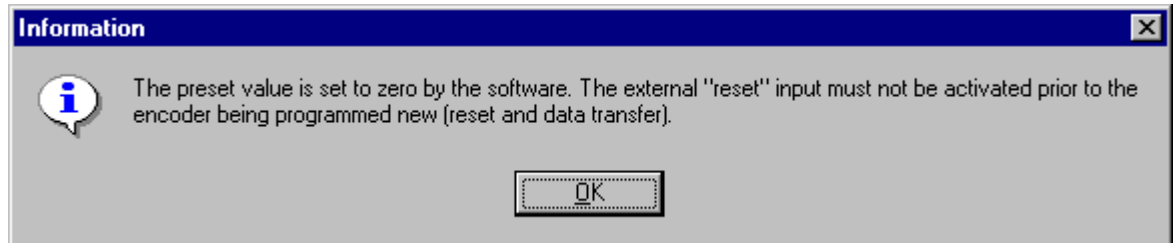

In the following window, the current position of the encoder is inquired continuously. It is possible to assign a desired position to the encoder. Select the field „assign position“ to set the desired value, which, however, must not exceed the value for the entire resolution. The selected position is taken over by clicking on „assign position“. There upon the set position value will appear in the field „inquire position“.

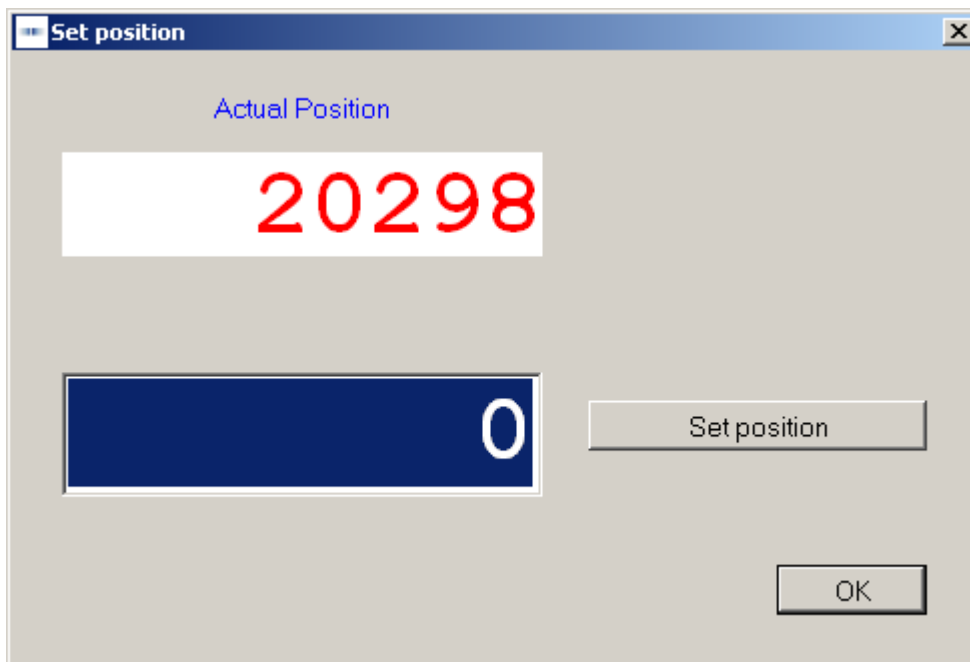

To the encoder models GXP1H, GXP1W, GXP2W with version 2C applies the following: After having assigned the preset value by the "set position" function, the external reset input must not be used.

4.7 Explanation „Teach In“

The „Teach In“ function serves to scale the encoder automatically. This facilitates the programming of the encoder for the user.

(The function may vary according to the corresponding encoder model).

When the „Teach In“ function is selected, a message appears saying that the resolution of the encoder will be set to the maximum value:

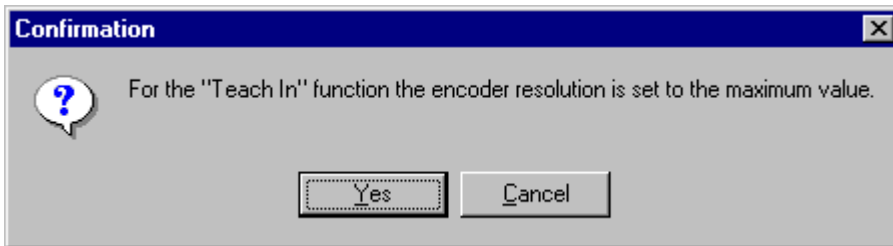

Click „Yes“ to confirm the setting of the encoder to the maximum resolution. The following window will be displayed:

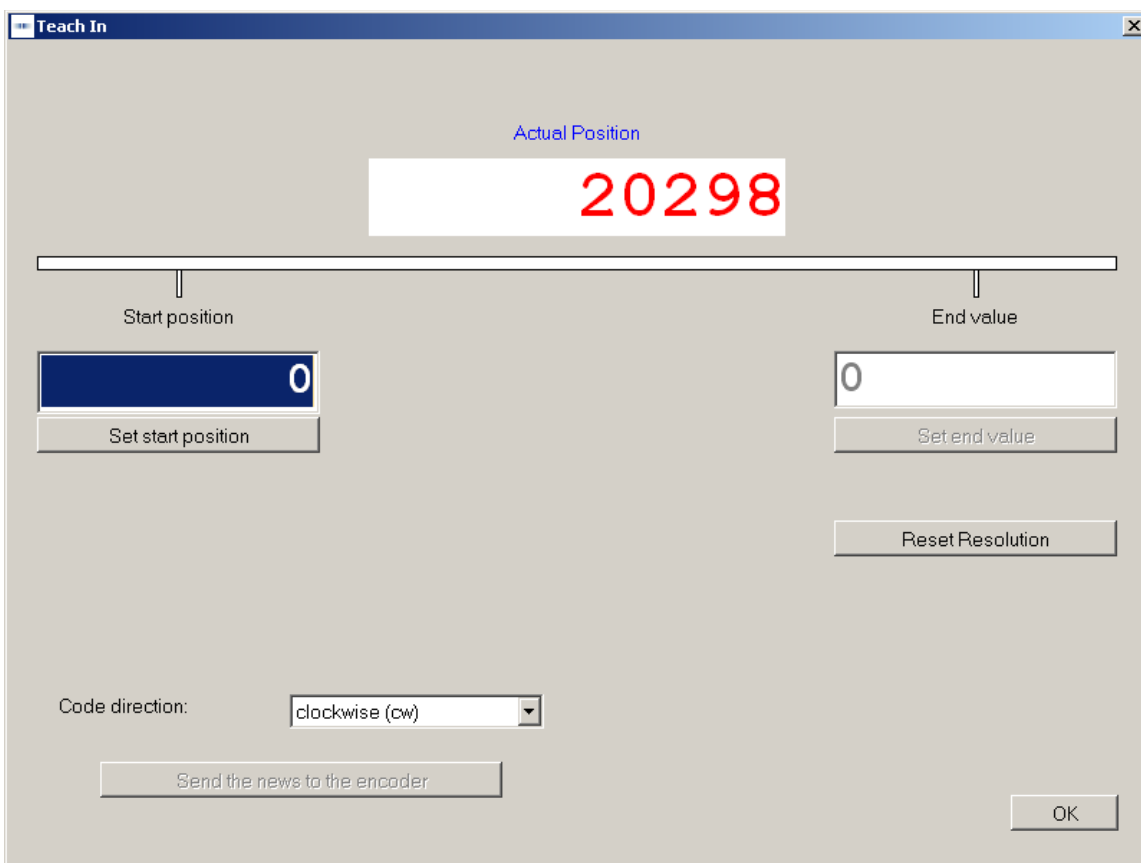

In the field „current position“, the current value of the encoder with max. resolution is displayed.

For scaling of the encoder as required, please proceed as follows:

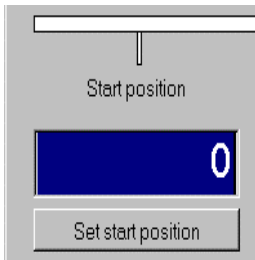

Bring the encoder to the desired start position by turning the encoder shaft. Enter the desired start value in the entry field start position, e.g. 0. Confirm entry by clicking „assign start position“.

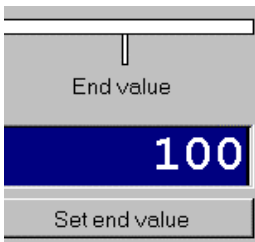

Thereupon bring encoder to the required end position and enter the desired end position, e.g. 100, in the field end position. Confirm entry by clicking „assign end position“.

Attention: The set direction of rotation must correspond to the actual direction.

After having proceeded as above steps a window will appear showing the corresponding scaling.

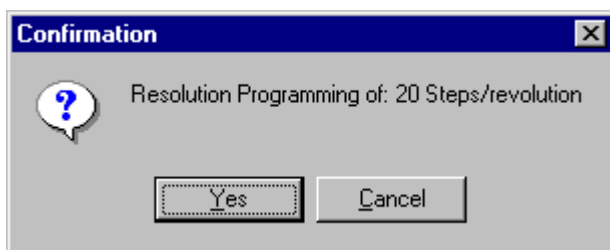

For a new automatic scaling, set the encoder to max. resolution by clicking „reset resolution“ and proceed according to the above-mentioned steps.



The „Teach In“ function is capable to calculate the turns/steps in whole numbers only, reason why there is a corresponding rounding up or down. The maximum possible rounding difference is +/- 0,5 steps. As a consequence, the start count is differing from the desired one after „Teach In“ has been effected. The divergence resp. error is determined as follows:

1. How to check if there was any rounding:

Final position/ (steps/turn) = Number of turns, whole number \Rightarrow
No rounding error

Number of turns, no whole number \Rightarrow
Rounding error

2. Real value of steps/turn:

Final position /Value of turns as a whole number = real number

3. How to calculate the rounding difference:

Real value less automatically calculated value = rounding difference

4. Divergence of requested start count:

Rounding difference multiplied by number of turns completed = divergence in steps

5. How to calculate the rounding error:

Rounding difference/ automatically calculated value = relative error in %

Example:

Desired resolution range is from 0 to 1100

Automatically calculated value is 18 steps/turn

1. Check whether there was any rounding:
Final position/(steps/turn) = $1100/18 = 61,11$ (Value has been rounded)
2. Real value of steps/turn = $1100/61 = 18,032$
3. Rounding difference = $18,032 - 18 = 0,032$
4. Divergence after 61 turns = $0,032 \times 61 = 2$ steps
5. rounding error = $0,032/18 = 0,177 \%$

The range begins with start count 2 instead of zero whereas the final value remains at 1100. By the function „set position“ the value zero can be re-assigned to the start count. As a consequence, the final value is shifted by 2 steps to 1098.

Important:

All SSI encoders with software version 2C and up allow re-assignment of zero to the start count both for positive and negative shiftings. With all other SSI as well as parallel encoders the assignment of zero to the start count is possible for positive shiftings only.

4.8 Explanation cam switching mechanism

The programmable cam switching mechanism allows the execution of switching processes. In this case, altogether 250 cams can be programmed to 16 outputs (e.g. GN400 or GXN1W). A maximum number of 250 cams can be assigned to each of the 16 outputs.

Furthermore you can determine after how many steps and revolutions of the encoder shaft a cam is to trigger a switching process (on/off).

The input fields „ON steps“ and „OFF steps“ are for input of the number of turns to be realized by the cam unit after being switched on resp. off. The input fields „ON turns“ and „OFF turns“ are for input of the number of steps to be realized by the cam unit after being switched on resp. off.

A message gives information on the maximum possible value for both numbers of turns and steps.

After the selection of the register card „cam“ the following window will be displayed:

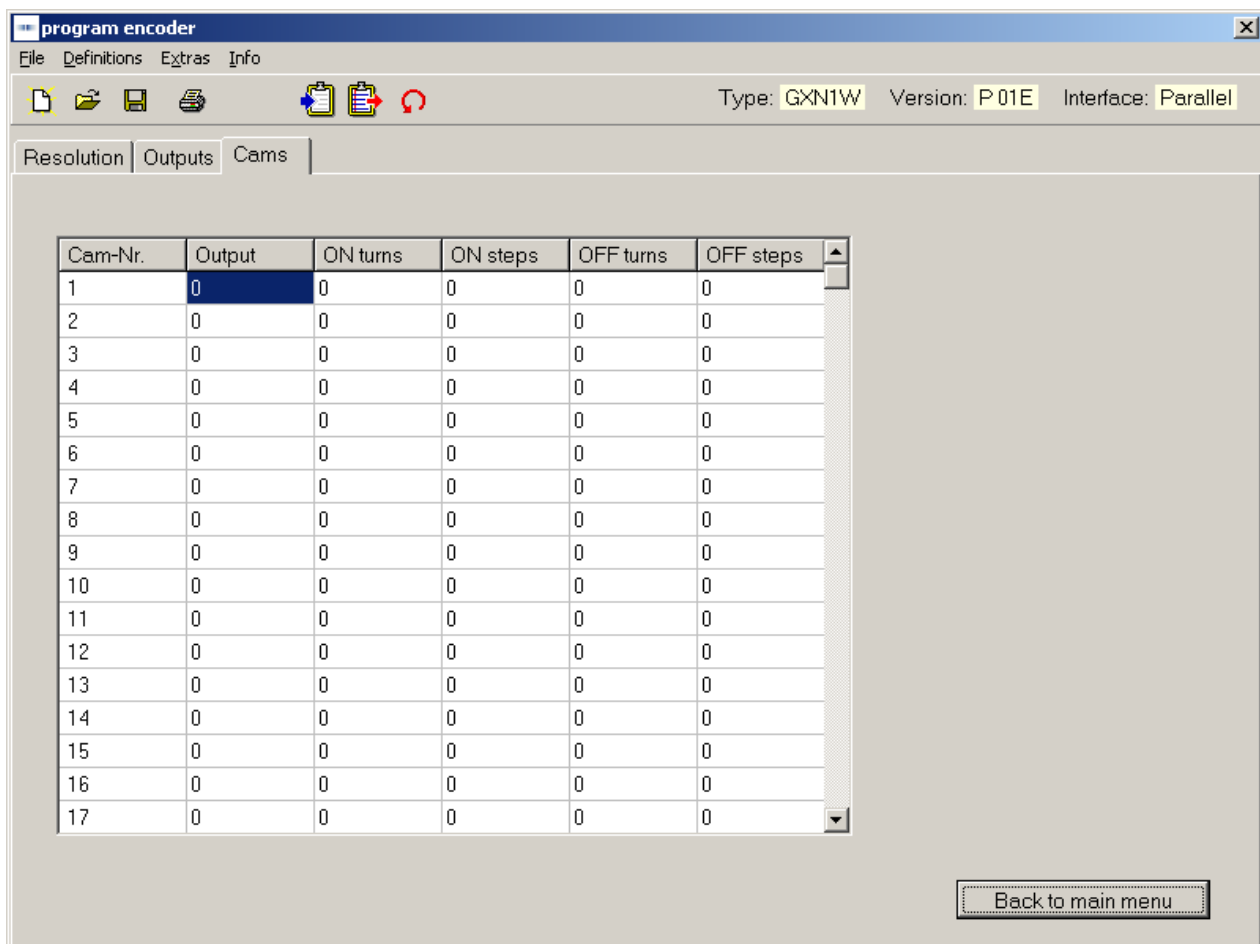

5 Wiring the encoders

5.1 Wiring between PC and encoder

In order to facilitate the connection between the PC and the encoder, the encoder is equipped with a RS232 interface. In addition, the encoder can be directly connected to the PC. For any transmission distance of more than 30 m RS485 interface is recommended.

5.1.1 Contact parallel encoder

In order to program the parallel encoders with the PC, the lines TxD, RxD and GND must be connected.

Contact assignment for shaft encoder:

Shaft encoder function	M12 connector, 5-pin	PC contact D-SUB, 9-pin
-	Pin 1	-
RxD	Pin 2	Pin 3
GND	Pin 3	Pin 5
TxD	Pin 5	Pin 2
		Br. Pin 4 to 6
		Br. Pin 7 to 8

Also connect the encoder via the device plug to voltage (UB/red/Pin 36 and GND/blue/Pin 37).

Accessories: Z 139.005 Programming cable for parallel shaft encoder
 Programming software ProGeber
 Manual on CD



Contact assignment for hollow shaft encoder:

Hollow shaft function	D-SUB connector, 37-pin	PC contact D-SUB, 9-pin
UB	Pin 36	-
RxD	Pin 35	Pin 3
GND	Pin 37	Pin 5
TxD	Pin 34	Pin 2
		Br. Pin 4 to 6
		Br. Pin 7 to 8

Also connect the encoder via the device plug to voltage (UB/red and GND/blue).

Accessories: Z 139.006 Programming cable for parallel encoder with hollow shaft
 Programming software ProGeber
 Manual on CD



5.1.2 Contact SSI encoder

To program the SSI encoder with the PC, the lines TxD, RxD and GND must be connected.

Contact assignment:

Encoder function	M23 connector, 16-pin	PC contact D-SUB, 9-pin
UB	Pin 15	-
RxD	Pin 5	Pin 3
GND	Pin 12	Pin 5
TxD	Pin 4	Pin 2
		Br. Pin 4 to 6
		Br. Pin 7 to 8

Also connect encoder via the device plug to voltage (UB/red and GND/blue).

Accessories: Z 139.004 Programming cable for SSI shaft encoders and encoders with hollow shaft
 Programming software ProGeber
 Manual on CD



5.1.3 Contact SSI bus cover

To program the SSI bus cover with the PC, the lines TxD, RxD and GND must be connected.

Contact assignment:

Encoder function	M12 encoder connector, 5-pin	PC contact D-SUB, 9-pin
UB	Pin 1	-
RxD	Pin 2	Pin 3
GND Prg.	Pin 3	Pin 5
GND B	Pin 4	Pin 5
TxD	Pin 5	Pin 2
		Br. Pin 4 to 6
		Br. Pin 7 to 8

Also connect encoder via the device plug to voltage UB (red) and GND (blue).

Accessories: Z 139.008 Programming cable for SSI bus encoders
 Programming software ProGeber
 Manual on CD



6 Appendix

6.1 Description of parallel encoder

In case of the parallel interface, the position value is output parallel via a maximum of 24 outputs. The following special inputs are available:

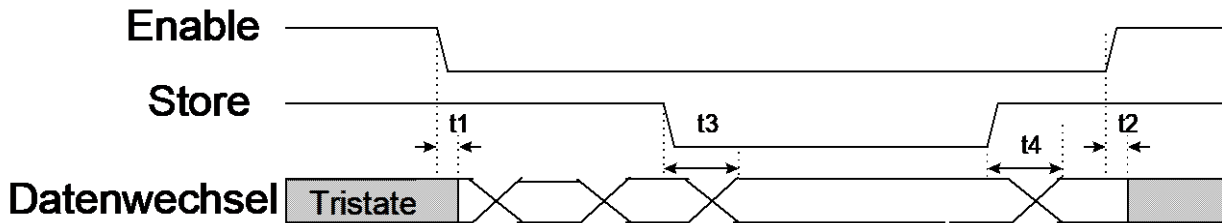

Course of signal	Runtime / typical	Time
Enable	t1 / t2	60 μ s
Store	t3 / t4	200 μ s

Enable: If this input is at Low level, the output drivers will be activated. If open-circuited or if high potential is applied, the output drivers will turn to the high-resistance state.

Store: When a Low level is applied, the data of the absolute encoder is temporarily stored. If this input is connected to high potential or if it is open-circuited, the current position data of the absolute encoder is switched through to the output drivers. This line must be used to ensure safe data readout in binary code.

Caution: If the enable input is open-circuited or if high potential is applied, the output drivers will turn to the high-resistance state (Tristate).

6.2 Description of SSI encoder

The SSI (**S**ynchronous **S**erial **I**nterface) transmits the position value serially, i.e. bit by bit from the encoder to the control. The transmission works according to the following scheme:

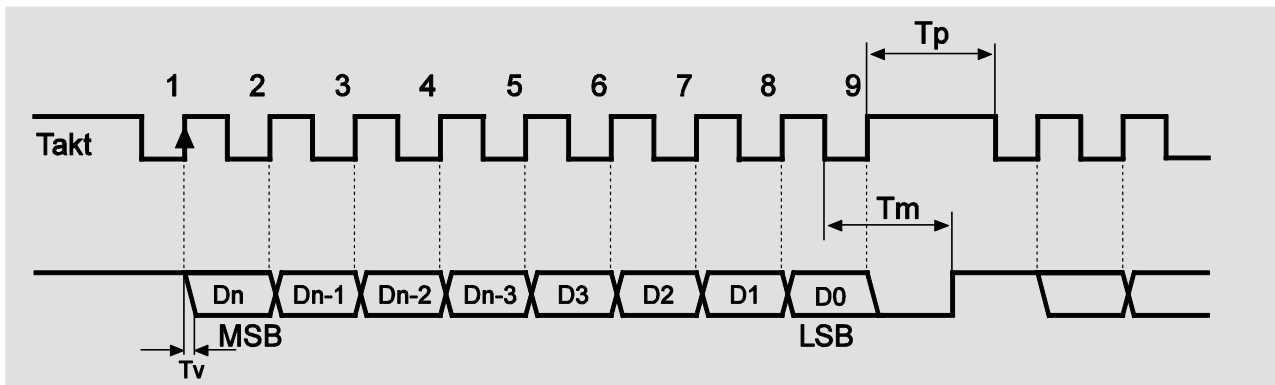

Description

Mono-flop time T_m :	20 μ s (adjustable)
Delay time T_v :	Delay time pulse edge until data output max. 300 ns
Pulse space T_p :	min. 25 μ s
Data bit Dn:	MSB
Data bit D1:	LSB (or special bits)

In the closed-circuit state, the data and pulse lines are at High level (+5 V). The transmission is started by the first trailing edge. With the corresponding following rising edge, the data bits are output to the data line one after the other. The MSB makes the start. If the number of pulses is higher than the number of data bits, only zeros will be sent after the data bits.

After the end of the pulse sequence, the data lines are kept at Low level (0 volt) during the mono-flop time T_m .

For the wiring, it is recommended to use data and pulse lines which are twisted in pairs. In case of lengths of lines exceeding 100 m, the data and pulse lines should have a minimum cross section of 0.25 mm² and the supply voltage line of 0,5 mm². The range of the pulse rate is between 62,5 kHz and 1,5 MHz. The maximum length of line depends on the SSI pulse frequency and should be adapted to the following table:

Length of line	Highest admissible SSI pulse frequency
12,5 m	810 kHz
25 m	750 kHz
50 m	570 kHz
100 m	360 kHz
200 m	220 kHz
400 m	120 kHz
500 m	100 kHz