

Manual

Absolute encoder with EtherCAT (with bus cover)

Firmware version 5.00 and up

Content	Page
1. Introduction	5
1.1 Scope of delivery	5
1.2 Product classification	5
2. Safety and operating instructions	6
3. Bus cover – functional principle	7
4. Encoder operating parameters	8
5. Encoder data	9
5.1 PDO (Process Data Object)	9
5.2 SDO (Service Data Objects)	10
5.3 Parameterization	18
5.4 Free Run Mode (default)	19
5.5 Distributed Clocks Mode	20
5.5.1 Activation Distributed Clocks under TwinCAT	20
5.6 Network management	22
6. Terminal assignment and commissioning	24
6.1 Mechanical mounting	24
6.2 Electrical connection	24
6.2.1 Initialising under TwinCAT system manager	25
6.2.2 Terminal assignment	26
6.3 Display elements	27
6.3.1 State indicator	27
6.3.2 Link/Activity indicator	27
6.4 Cycle times	28
6.5 Configuration 10 Byte PDO / 4 Byte PDO / 2 Byte PDO by TwinCAT	29

**TwinCAT is a trademark of the company BECKHOFF Industrie Elektronik

Disclaimer of liability

The present manual was compiled with utmost care, errors and omissions reserved. For this reason Baumer rejects any liability for the information compiled in the present manual.

Baumer nor the author will accept any liability for direct or indirect damages resulting from the use of the present information.

At any time we should be pleased receiving your comments and proposals for further improvement of the present document.

Created by:

Baumer Germany GmbH & Co. KG

Bodenseeallee 7

DE-78333 Stockach

www.baumer.com

1. Introduction

1.1 Scope of delivery

Please check the delivery upon completeness prior to commissioning.

Depending on encoder configuration and part number delivery is including:

Basic encoder, bus cover and CD with describing file and manual (also available as download)

1.2 Product classification

Product mechanics Solid / Hollow shaft / Kit	Product name (according to object 1008)	Description
BMMV / BMMH / BMMK	GCMMW_H	MT, <i>MAGRES</i>
BMSV / BMSH / BMSK	GCAMW_H	ST, <i>MAGRES</i>
GBMMW / GBMMS / -	GBMMW_H	MT, Optical, 18 Bit ST
GBAMW / GBAMS / -	GBAMW_H	ST, Optical, 18 Bit ST
GXMMW / GXMMS / -	GXMMW_H	MT, Optical, 13 Bit ST
GXAMW / GXAMS / -	GXAMW_H	ST, Optical, 13 Bit ST

Note:

Ever apply the matching device file (BAUMER Group absolute EtherCAT encoders.xml) on the above device types.

Explanation:

MT	Multiturn encoder
ST	Singleturn encoder
<i>MAGRES</i>	Extremely robust encoder with magnetic sensing principle
18 Bit ST	High resolution encoder – up to 18 bit physical singleturn resolution, i.e. 2^{18} steps / revolution
13 Bit ST	Max. 13 bit physical singleturn resolution, i.e. 2^{13} steps / revolution

2. Safety and operating instructions

Intended use

- The encoder is a precision measuring device that is used to record positions and speeds. It provides measuring values as electronic output signals for the subsequently connected device. It must not be used for any other purpose. Unless this product is specially labeled, it may not be used for operation in potentially explosive environments.
- Make sure by appropriate safety measures, that in case of error or failure of the encoder, no danger to persons or damage to the system or operating facilities occurs.

Personnel qualification

- Installation and assembly of this product may be performed only by a person qualified in electronics and precision mechanics.

Maintenance

- The encoder is maintenance-free and must not be opened up nor mechanically or electronically modified. Opening up the encoder can lead to injury.

Disposal

- The encoder contains electronic components. At its disposal, local environmental guidelines must be followed.

Mounting

- Solid shaft: Do not connect encoder shaft and drive shaft rigidly. Connect drive and encoder shaft with a suitable coupling.
- Hollow shaft: Open clamping ring completely before mounting the encoder. Foreign objects must be kept at a sufficient distance from the stator coupling. The stator coupling is not allowed to have any contact to the encoder or the machine except at the mounting points.

Electrical commissioning

- Do not proceed any electrical modifications at the encoder.
- Do not proceed any wiring work while encoder is live.
- Do not remove or plug on connector whilst under power supply.
- Ensure that the entire system is installed in line with EMC/EMI requirements. Operating environment and wiring have an impact on the electromagnetic compatibility of the encoder. Install encoder and supply cables separately or far away from sources with high emitted interference (frequency converters, contactors, etc.).
- When working with consumers with high emitted interference provide separate encoder supply voltage.
- Completely shield encoder housing and connecting cables.
- Connect encoder to protective earth (PE) using shielded cables. The braided shield must be connected to the cable gland or connector. Ideally, aim at dual connection to protective earth (PE), i.e. housing by mechanical assembly and cable shield by the downstream devices.

Supplementary information

- The present manual is intended as a supplement to already existing documentation (e.g. catalogues, data sheets or mounting instructions).

3. Bus cover – functional principle

The product family architecture is modular. Depending on what is required from the encoder, the basic encoder and bus covers can be combined at will with the selected bus system.

The basic encoders differ in terms of accuracy, ambient conditions and the utilized sensing principle.

Bus cover

The bus cover accommodates the entire electronics for measured value processing and for Ethernet communication.

The bus covers differ by the respectively integrated bus interface.

Available bus interfaces: CANopen®, DeviceNet, EtherCAT, Ethernet/IP, Profibus-DP, Profinet, Powerlink, Power over EtherCAT, SAE J1939, SSI.

All encoders enable parameterization by bus interface.

Functional principle:

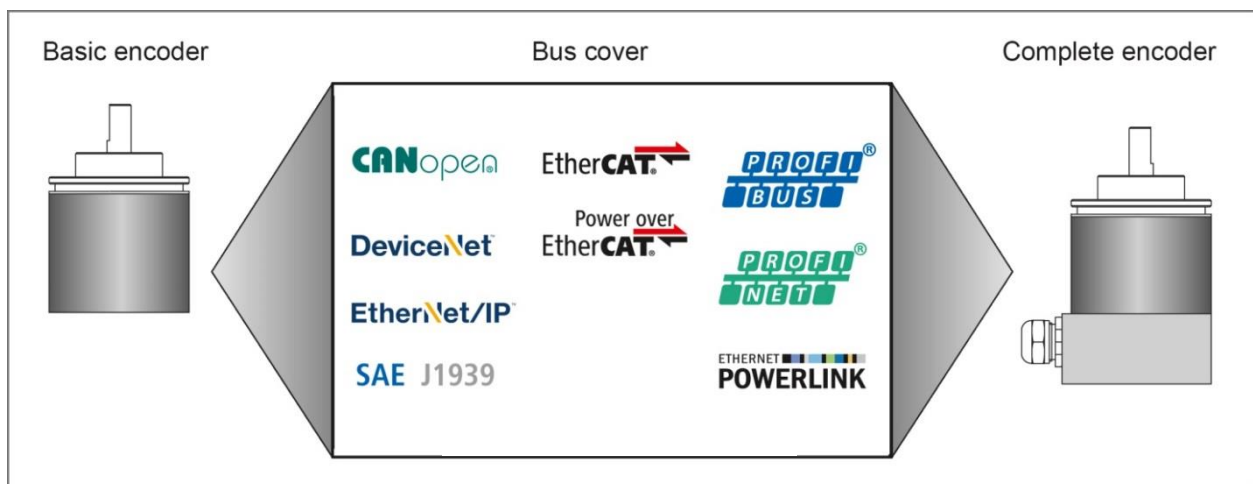

4. Encoder operating parameters

Significance of operating parameters

Product	Device Name	Resolution per turn 0x6001			Number of turns 0x6502			Measuring range 0x6002		
		Dezimal	Hex	Bit	Dezimal	Hex	Bit	Dezimal	Hex	Bit
BMSx	GCAMW_H	4096	1000	12	1	1	0	4096	1000	12
BMMx	GCMMW_H	4096	1000	12	65536	10000	16	268435456	10000000	28
GXAMW(S)	GXAMW_H	8192	2000	13	1	1	0	8192	2000	13
GXMMW(S)	GXMMW_H	8192	2000	13	65536	10000	16	536870912	20000000	29
GBAMW(S)	GBAMW_H	262144	40000	18	1	1	0	262144	40000	18
GBMMW(S)	GBMMW_H	262144	40000	18	16384	4000	14	4294967296	100000000	32

The enabled scaling functionality in CoE is prerequisite for further user-specific parameterization such as resolution, total measuring range, direction of rotation and preset.

See chapter: SDO (Service Data Objects)

5. Encoder data

5.1 PDO (Process Data Object)

Depending on the configuration, the encoder will provide the following process data (input data):

XML file	PDO Mapping	Product code	Applied in version
BAUMER Group absolute EtherCAT encoders.xml	10Byte PDO: (default) 4 Byte Position value 2 Byte Warnings 4 Byte System Time/Speed value or	20	V5.00 and up
	4Byte PDO: (configurable) 4 Byte Position value	25	
	2Byte PDO: (configurable) 2 Byte Position value	30	

10Byte PDO (Default)

Value	Data type	Explanation
Position value	UDINT	Current absolute encoder position value. For range-related information refer to „Encoder operating parameters“
Warnings	UINT	Warnings Bit 2: 1 → Lithium battery power low Bit 4: 1 → Excess shaft turns during power-off Bit 5: 1 → Incorrect encoder configuration
System Time	UDINT	Present system time, resolution in ns, alternative Speed Value DINT

4Byte PDO

Value	Data type	Explanation
Position value	UDINT	Current absolute encoder position value. For range-related information refer to „Encoder operating parameters“

2Byte PDO

Value	Data type	Explanation
Position value	UINT	Current absolute encoder position value. For range-related information refer to „Encoder operating parameters“

The configuration 4Byte PDO / 2Byte PDO allows for shorter cycle times.

Cycle times are configuration-related, see chapter [cycle times](#)

5.2 SDO (Service Data Objects)

SDOs access is in the TwinCAT System under tab **CoE - Online (CANopen over EtherCAT)**.

Since there is a large variety of CANopen device and application profiles they may be applied in EtherCAT slaves.

EtherCAT encoders provide partial implementation of the CANopen DS406 encoder device profile.

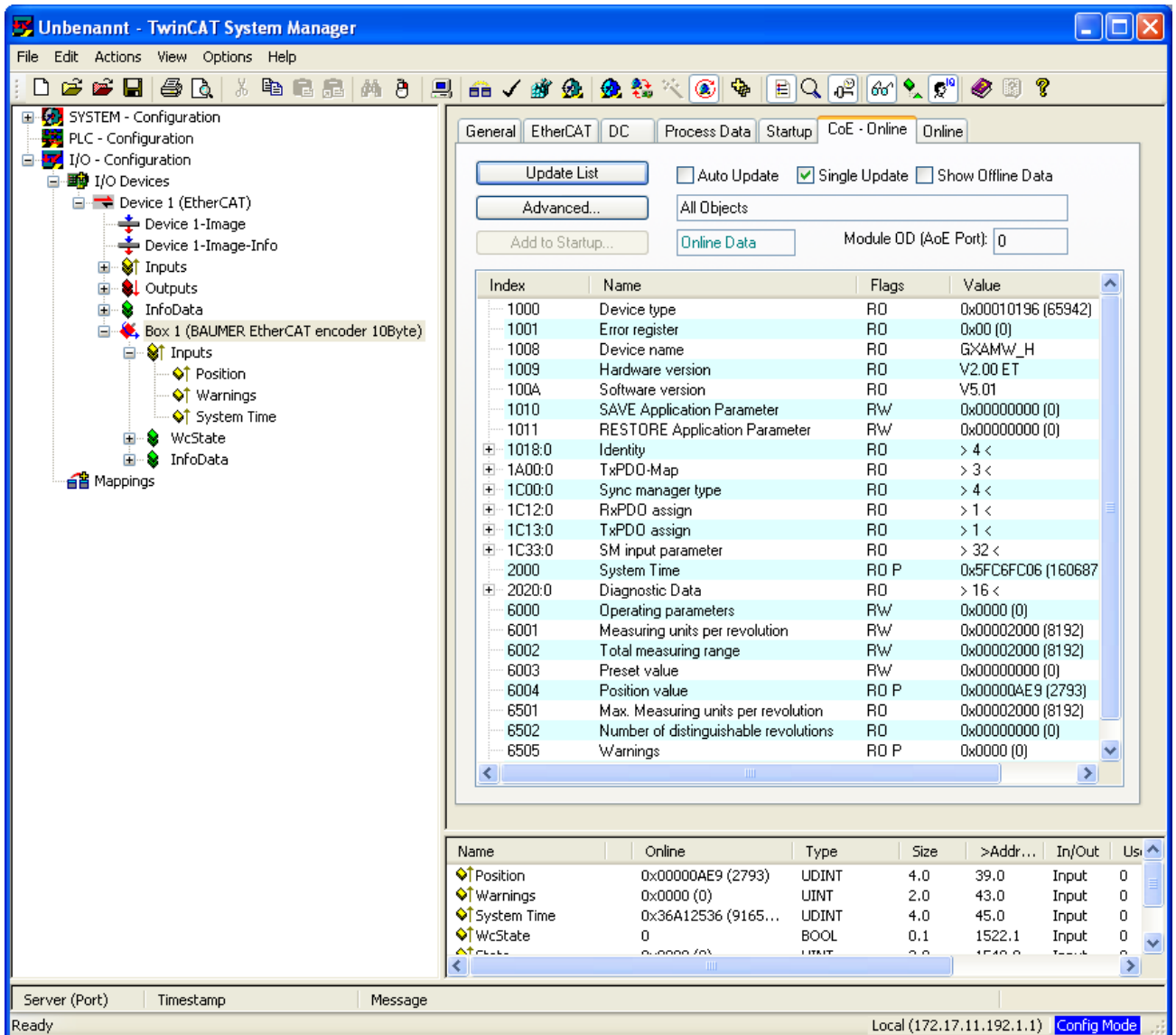

The screenshot shows the TwinCAT System Manager interface. The left pane displays a tree view of the configuration, with 'Box 1 (BAUMER EtherCAT encoder 10Byte)' selected under 'I/O Devices'. The right pane shows the 'CoE - Online' configuration window, which includes a table of SDOs and a list of variables.

Index	Name	Flags	Value
1000	Device type	RO	0x00010196 (65942)
1001	Error register	RO	0x00 (0)
1008	Device name	RO	G×AMW_H
1009	Hardware version	RO	V2.00 ET
100A	Software version	RO	V5.01
1010	SAVE Application Parameter	RW	0x00000000 (0)
1011	RESTORE Application Parameter	RW	0x00000000 (0)
1018:0	Identity	RO	> 4 <
1A00:0	TxPDO-Map	RO	> 3 <
1C00:0	Sync manager type	RO	> 4 <
1C12:0	RxPDO assign	RO	> 1 <
1C13:0	TxPDO assign	RO	> 1 <
1C33:0	SM input parameter	RO	> 32 <
2000	System Time	RO P	0x5FC6FC06 (160687)
2020:0	Diagnostic Data	RO	> 16 <
6000	Operating parameters	RW	0x0000 (0)
6001	Measuring units per revolution	RW	0x00002000 (8192)
6002	Total measuring range	RW	0x00002000 (8192)
6003	Preset value	RW	0x00000000 (0)
6004	Position value	RO P	0x00000AE9 (2793)
6501	Max. Measuring units per revolution	RO	0x00002000 (8192)
6502	Number of distinguishable revolutions	RO	0x00000000 (0)
6505	Warnings	RO P	0x0000 (0)

Name	Online	Type	Size	>Addr...	In/Out	Usi
Position	0x00000AE9 (2793)	UDINT	4.0	39.0	Input	0
Warnings	0x0000 (0)	UINT	2.0	43.0	Input	0
System Time	0x36A12536 (9165...)	UDINT	4.0	45.0	Input	0
WcState	0	BOOL	0.1	1522.1	Input	0

Please consider that every CoE access (mailbox communication) will shortly interrupt generation of encoder input data for the time of mailbox communication. With short cycle times in Distributed Clocks Mode this may imply that not in every Sync cycle a new position is detected.

Object list Detailed explanations on the most important SDO objects
Object 0x1000 Device Type

SubIndex	0
Data type	Unsigned 32
Access	ReadOnly
Default	Multiturn: 0x00020196 Singleturn: 0x00010196h
EEPROM	No
Significance	Information on device profile and device type
Values	

Object 0x1008 Device Name

SubIndex	0
Data type	VISIBLE_STRING
Access	ReadOnly
Default	According to connected basic encoder "GXMMW_H","GXAMW_H","GCMMW_H","GCAMW_H", "GBMMW_H","GBAMW_H"
EEPROM	No
Significance	Device name in ASCII
Values	

Object 0x1009 Hardware Version

SubIndex	0
Data type	VISIBLE_STRING
Access	ReadOnly
Default	
EEPROM	No
Significance	Hardware version in ASCII
Values	

Object 0x100A Manufacturer Software Version

SubIndex	0
Data type	VISIBLE_STRING
Access	ReadOnly
Default	
EEPROM	No
Significance	Software version in ASCII
Values	

Object 0x1010 SAVE Application Parameter

Object 0x1010 is utilized to save device-specific objects (0x6000..0x6FFF) out of RAM into non-volatile memory (EEPROM). To prevent inadvertent saving operations the signature „**save**“ must be written into object 0x1010 Subindex 0.

Signature	MSB	LSB	
ISO 8859	e	v	a
	0x65	0x76	0x61
		s	0x73
	1702257011		
			character
			hex
			dez

Object 0x1011 RESTORE Application Parameter

Object 0x1011 restores ROM default in device-specific objects (0x6000..0x6FFF) both in RAM and EEPROM. To prevent any inadvertent restore, the signature „load“ must be written in object 0x1011 Subindex 0.

Signature	MSB				LSB			
ISO 8859	d	a	o	l	character			
	0x64	0x61	0x6F	0x6C	hex			
	1684107116				dez			

Object 0x1018 Identity Object

SubIndex	0
Data type	Unsigned 8
Access	ReadOnly
Default	4
EEPROM	No
Significance	Maximum supported subindex
Values	4 = Maximum supported subIndex

SubIndex	1
Data type	Unsigned 32
Access	ReadOnly
Default	Ech
EEPROM	No
Significance	VendorID for Baumer Germany GmbH & Co. KG assigned by CiA
Values	0xEC (in the Internet under www.can-cia.de)

SubIndex	2
Data type	Unsigned 32
Access	ReadOnly
Default	0x0A → GXMMW_H ; 0x0B → GXAMW_H 0x0C → GCMMW_H ; 0x0D → GCAMW_H 0x0E → GBMMW_H, 0x0F → GBAMW_H
EEPROM	No
Significance	Product Code
Values	

SubIndex	3
Data type	Unsigned 32
Access	ReadOnly
Default	
EEPROM	No
Significance	Revision no.
Values	

SubIndex	4
Data type	Unsigned 32
Access	ReadOnly
Default	
EEPROM	No
Significance	Serial no.
Values	

Object 0x1A00 TxPDO1 Mapping

SubIndex	0
Data type	Unsigned 8
Access	ReadOnly
Default	
EEPROM	No
Significance	Maximum supported subindex
Values	3

SubIndex	1
Data type	Unsigned 32
Access	ReadOnly
Default	
EEPROM	No
Significance	Position value
Values	0x6004

SubIndex	2
Data type	Unsigned 16
Access	ReadOnly
Default	
EEPROM	No
Significance	Warnings
Values	0x6505

SubIndex	3
Data type	Unsigned 32
Access	ReadOnly
Default	0x2000 System time
EEPROM	Yes
Significance	System time, Speed value
Values	0x2000 = System time, 0x6030 = Speed value

Object 0x1C33 SM (Sync Manager) Input Parameter SM3

Sub Index	Data Type	Access	Description	Measurand	Values
0	Unsigned 8	ReadOnly	SM Input Parameter	-	Maximum supported Subindex 32
1	Unsigned 16	ReadOnly	Sync Mode	-	0x00 Free Run (not synchronized) 0x03 DC SYNC1, synchronized with SYNC1 Event
2	Unsigned 32	ReadOnly	Cycle time	Nanoseconds ns	SYNC0/SYNC1 cycle time
3	Unsigned 32	ReadOnly	Shift time	Nanoseconds ns	Shift time from SYNC1 until input data latch (absolute position)
4	Unsigned 16	ReadOnly	Sync modes supported	-	0x0009 Free run supported Synchronous supported DC SYNC1 Dynamic Cycle times
5	Unsigned 32	ReadOnly	Minimum cycle time	Nanoseconds ns	Minimum cycle time supported
6	Unsigned 32	ReadOnly	Calc and copy time	Nanoseconds ns	Calculation and copy time of process data out of local memory into SyncManager

Device-specific objects

Object Data in this area are hold volatile in RAM after any change. To save in non-volatile EEPROM use object SAVE Application Parameter 0x1010.

Object 0x6000 Operating parameters

SubIndex	0
Data Type	Unsigned 16
Access	ReadWrite
Default	0, scaling OFF, CW, Speed Value readout in steps /s
EEPROM	Yes
Significance	Operating parameters
Values	Bit 0: Direction of rotation 0 CW 1 CCW Any parameter other than default will only become effective with enabled scaling function (0x6000). Bit 2: Scaling function ON/OFF 0 scaling disabled, encoder provides raw data (w/o offset) 1 scaling enabled, encoder provides scaled, offset-related position values Example: Value 0x0004 -> scaling On, CW Bit 12: Unit for Speed Value readout 0 steps/s 1 rpm

User-settable parameters such as resolution, total measuring range, direction of rotation and preset will not become effective until the scaling function is enabled (bit 2 =1).

See chapter parameterization.

The above parameters will be preliminarily saved in the volatile RAM memory and can optionally be saved non-volatile in EEPROM using object SAVE Application Parameter (0x1010).

Please note that with scaling ON the input data (TxPDO) will be produced much more slowly, i.e. PLC cycle times for encoder readout should be correspondingly enlarged.

See chapter cycle times.

Object 0x6001 Measuring units per revolution

SubIndex	0
Data type	Unsigned 32
Access	ReadWrite
Default	0x2000 = 8192 = 13bit → GXxMW_H 0x1000 = 4096 = 12bit → GCxMW_H 0x40000 = 262144 = 18bit → GBxMW_H, GDxMW_H
EEPROM	Yes
Significance	Optional number of steps per revolution.
Values	1..n.. max. number of steps per revolution (0x6501) Entries ≠ default values are only effective with enabled scaling function (0x6000).

In general, when writing on this object any previously saved offset (0x6509) will be cleared (value = 0).

Object 0x6002 Total measuring range

SubIndex	0
Data type	Unsigned 32
Access	ReadWrite
Default	0x20000000 = 536870912 = 29bit → GXMMW_H 0x2000 = 8192 = 13bit → GXAMW_H 0x10000000 = 268435456 = 28bit → GCMMW_H 0x1000 = 4096 = 12bit → GCAMW_H 0x80000000 = 2147483648 = 31bit ² → GBMMW_H 0x40000 = 262144 = 18bit → GBAMW_H
EEPROM	Yes
Significance	Total measuring range in steps optionally programmable. Consequence: Number of revolutions = total measuring range / resolution The maximum resolution (0x6502) must not be exceeded since otherwise the selected total resolution range is too wide and will be rejected.
Values	1..n.. max. total measuring range in steps (0x 6502) Entries ≠ default values are only effective with enabled scaling function (0x6000).

² with disabled scaling 32 bit

Writing in these object will clear any previously saved offset (0x6509, value = 0)

Important for multiturn encoder operation:

Continuous operation will be automatically supported where required.

Consequently, no specific relationship between total measuring range and measuring units per revolution must be observed in the parameterization.

With enabled continuous operation and during power off, the encoder shaft may be turned up to ¼ of the maximum permissible turns. Any excess turn may entail void position values which will be signaled by a warning and call for a new referencing operation.

Non-continuous operation allows for an unlimited number of turns during power-off.

Proceed as below to find out whether your parameterization enables continuous operation:

- The „maximum possible number of turns“ provided by the encoder (depending on the configuration: 16 bits = 65536 or 13 bits = 8192) is multiplied by the parameterized measuring units per revolution.
- The result is divided by parameterized total measuring range.
- A remainder in the result (fractional digits) means continuous operation enabled.

Example: Parameterization with disabled continuous operation:

Max. possible number of turns	65536	(16 bits multiturn)
Measuring units per turn :	3600	
Total measuring range	29.491.200	(8192 x 3600)
Calculation:	65536 x 3600 / 29.491.200 = 8 (no remainder)	

Example: Parameterization with enabled continuous operation:

Max. possible number of turns	65536	(16 bits multiturn)
Measuring units per turn	3600	
Total measuring range	100.000	
Calculation:	65536 x 3600 / 100.000 = 2359 remainder 29600	

Object 0x6003 Preset value

SubIndex	0
Data type	Unsigned 32
Access	ReadWrite
Default	0
EEPROM	Yes
Significance	Optionally programmable position value. In this operation an offset value is calculated and saved in object 0x6509.
Values	0..actual total measuring range (0x6002) -1 Entries ≠ default values are only effective with enabled scaling function (0x6000).

Object 0x6004 Position value

SubIndex	0
Data type	Unsigned 32
Access	ReadOnly
Default	
EEPROM	No
Significance	Value of actual position in steps
Values	0..actual total measuring range (0x6002) -1

Object 0x6030 Speed value

SubIndex	0
Data type	Signed 32
Access	ReadOnly
Default	
EEPROM	No
Significance	Current speed value
Values	Unit steps/s or rpm configurable by object 0x6000 Bit 12

Object 0x6031 Speed Parameter

SubIndex	0
Data type	Unsigned 8
Access	ReadOnly
Default	2
EEPROM	No
Significance	Largest supported Subindex
Values	2 = largest supported SubIndex

SubIndex	1
Data type	Unsigned 16
Access	ReadOnly
Default	2
EEPROM	No
Significance	Speed Source
Values	2: Speed is calculated out o raw data position

SubIndex	2
Data type	Unsigned 16
Access	Readwrite
Default	100
EEPROM	Yes
Significance	Integration time in ms, to generate the moving average speed value. To enhance dynamic capabilities select an inferior value. To improve smoothing select a larger value.
Values	1..1000

Object 0x6501 Max. measuring units per revolution (max. resolution in steps)

SubIndex	0
Data type	Unsigned 32
Access	ReadOnly
Default	0x2000 = 8192 = 13bit → GXxMW_H 0x1000 = 4096 = 12bit → GCxMW_H 0x40000 = 262144 = 18bit → GBxMW_H, GDxMW_H
EEPROM	No
Significance	Maximum singleturn resolution in steps
Values	

Object 0x6502 Number of distinguishable revolutions

SubIndex	0
Data type	Unsigned 32
Access	ReadOnly
Default	0x10000 = 65536= 16bit → GXMMW_H 0x10000 = 65536= 16bit → GCMMW_H 0x2000 = 8192 = 13bit ² → GBMMW_H
EEPROM	No
Significance	Maximum number of revolutions
Values	With singleturn encoders =0, otherwise according to basic encoder

² with disabled scaling 14 bit

Object 0x6505 (Warnings)

SubIndex	0
Data type	Unsigned 16
Access	ReadOnly
Default	0
EEPROM	No
Significance	Warnings
Values	Multiturn encoder Bit 2: 1 → Lithium battery voltage low Bit 4: 1 → Excess shaft turns during power off Bit 5: 1 → inappropriate sensor configuration

Object 0x6509 Offset

SubIndex	0
Data type	Unsigned 32
Access	ReadOnly
Default	0
EEPROM	Yes
Significance	Value is calculated upon writing on object Preset (0x 6003)
Values	

5.3 Parameterization

Proceed as below for user-specific parameterization of direction of rotation, resolution, total resolution, preset:

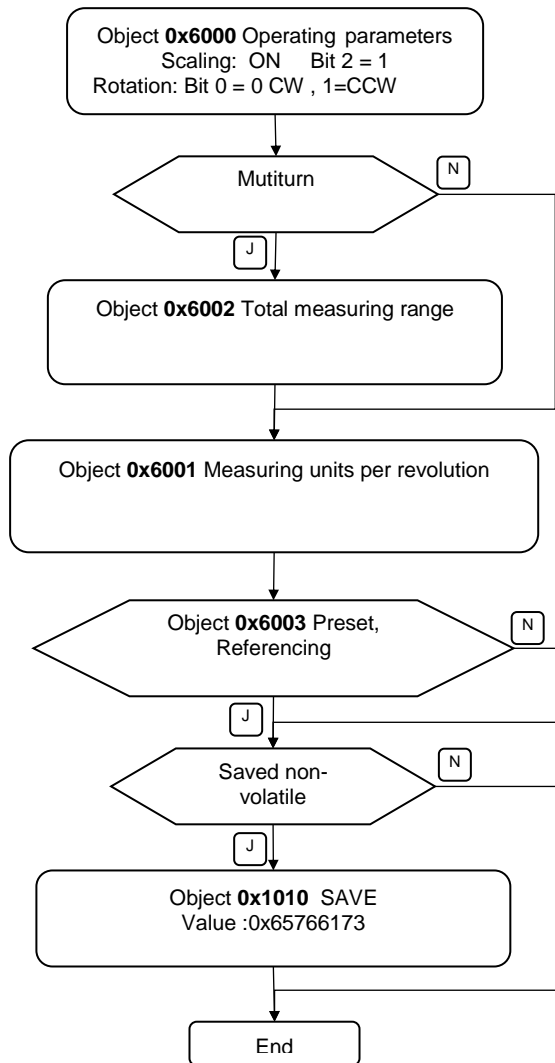

Examples: Scaling ON in object 0x6000

Scaling	Rotation	Value 0x6000
OFF	CW	0x0000
OFF	CCW	0x0001
ON	CW	0x0004
ON	CCW	0x0005

CW = clockwise = increasing values with clockwise shaft rotation

CCW = counterclockwise = increasing values with counterclockwise shaft rotation

Reference: when looking at flange

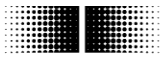

5.4 Free Run Mode (default)

In "Free Run" mode, a local timer interrupt of the application controller will trip the local cycle which in Free Run is independent of communication cycle and/or master cycle. The encoder will generate the process data in asynchronous cyclic manner.

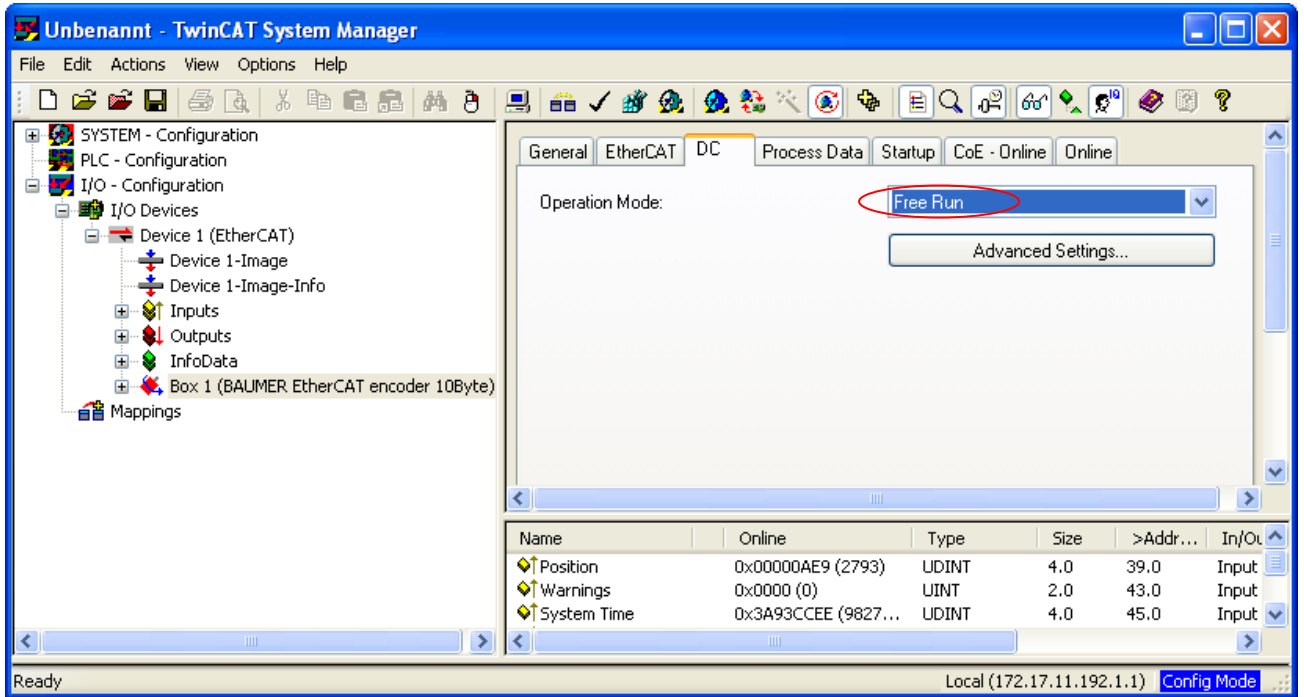
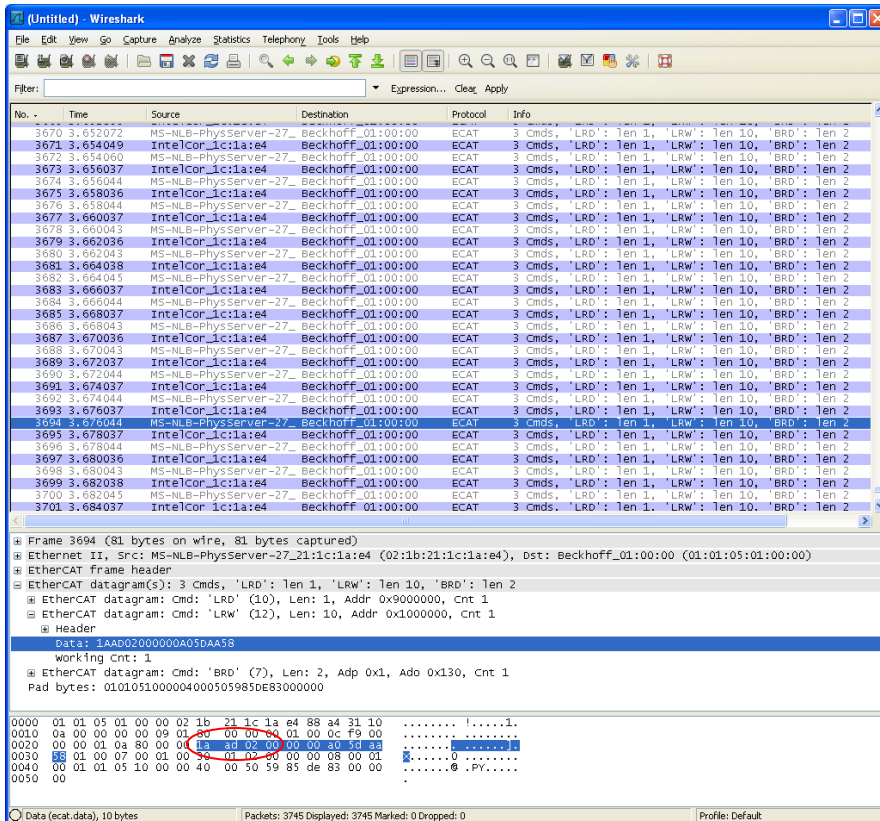

Fig.: Wireshark Network session, encoder input data



5.5 Distributed Clocks Mode

Distributed clocks mode enables exactly the same time with all bus users.

The encoder can be utilized and configured as reference clock for synchronisation purposes of both other users and master. Thus a high-precision time base is available throughout the network.

The encoder generates process data synchronously to a Sync Signal.

The local cycle will be tripped once SYNC0/SYNC1 Event has been received. Prior to receiving the next SYNC0/SYNC1 Event the process data frame must be completely processed by the slave.

5.5.1 Activation Distributed Clocks under TwinCAT

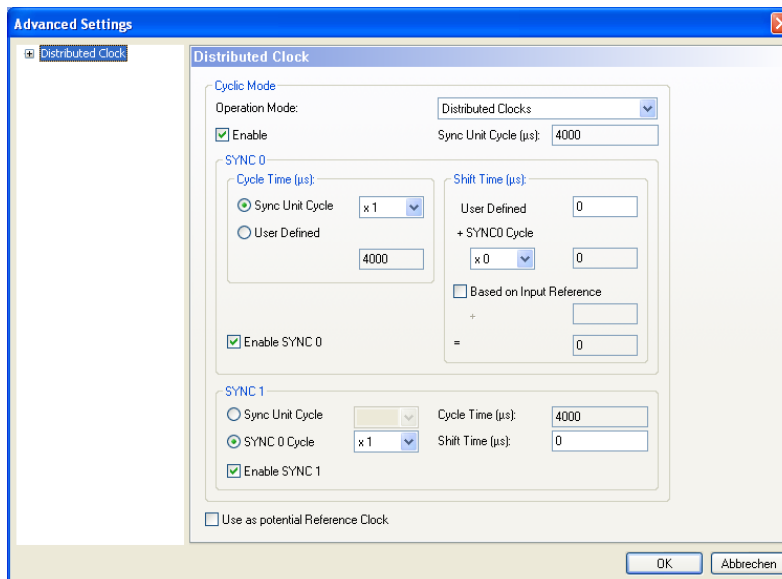
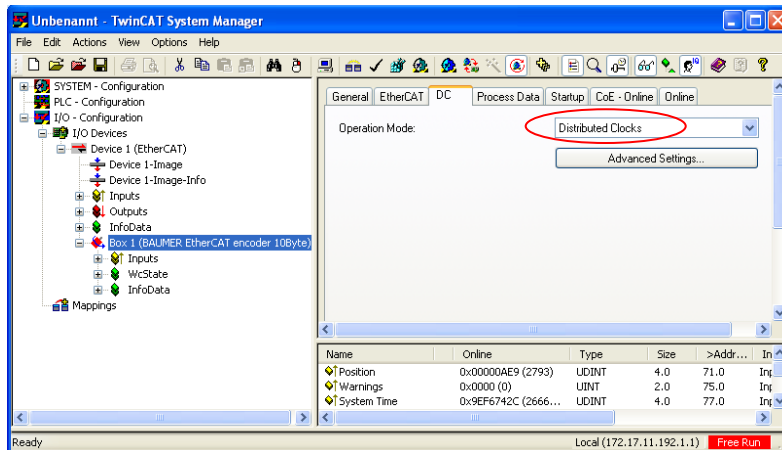

Important:

- Enable SYNC0 **and** SYNC1.
- Ever proceed any cycle time modification in the SYNC0 settings only.
- Do not alter any SYNC1 settings.

Fig.: Local cycle synchronized with SYNC0/SYNC1

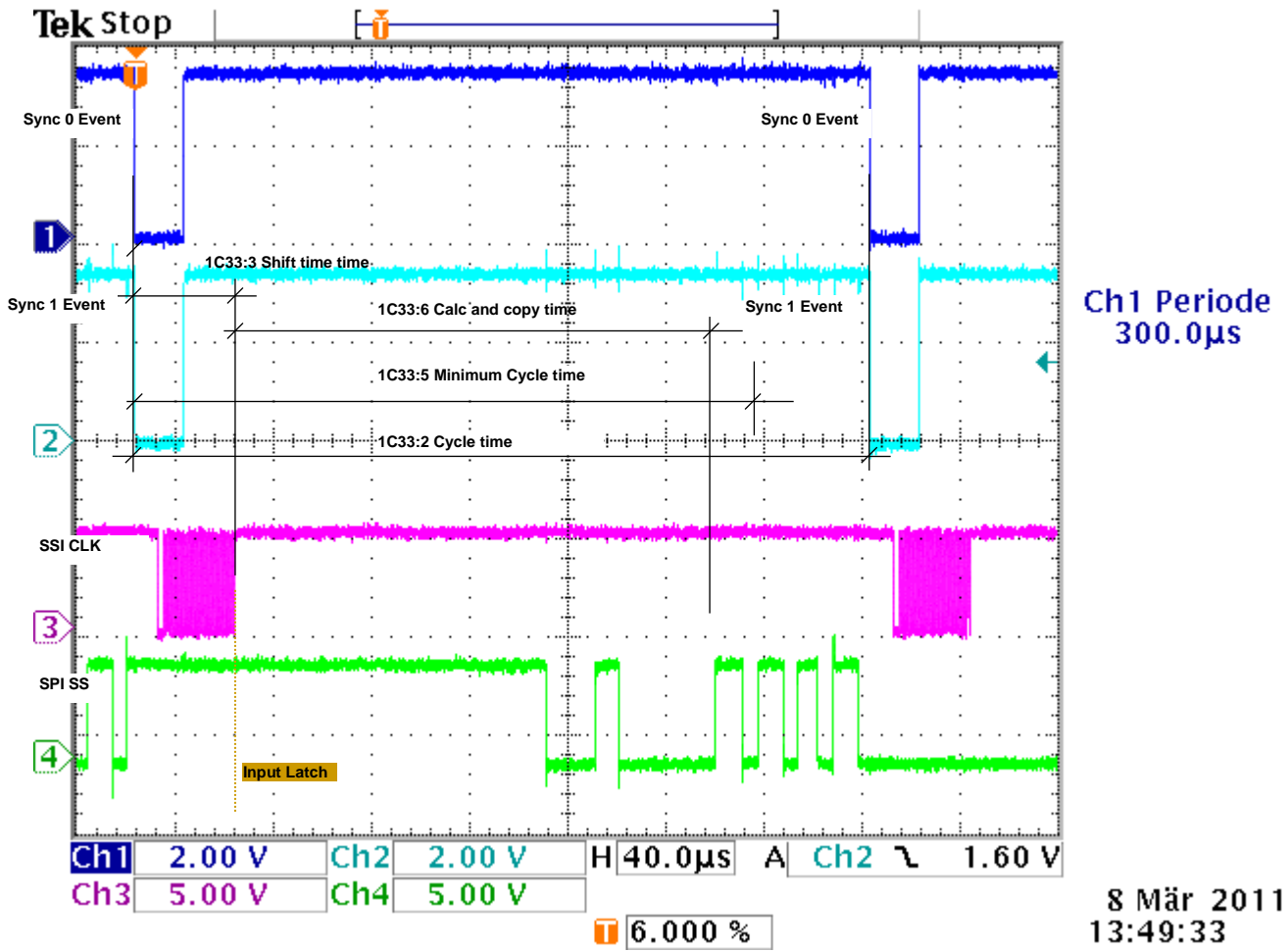

Cycle times corresponding to configuration, see chapter [Cycle times](#)

5.6 Network management

The encoder's State Machine can be switched in the TwinCAT System Manager under tab **Online**.

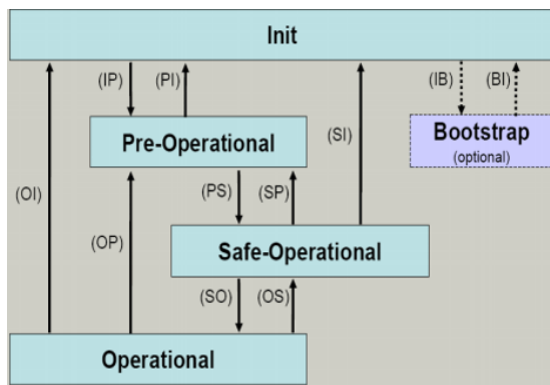
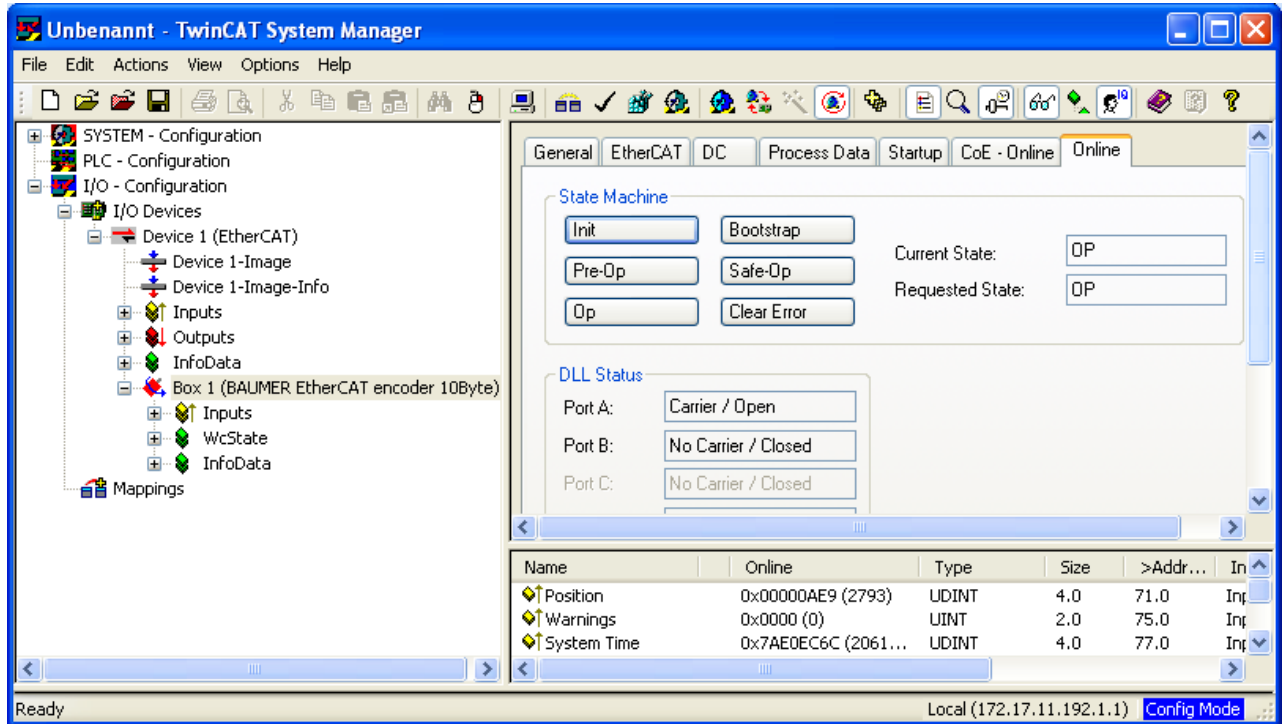

EtherCAT State Machine

The EtherCAT State Machine (ESM) will control the state of the EtherCAT slave with state-related access and execution of several functionalities. Specific commands by the EtherCAT master are required in each state during slave bootup.

The states of an EtherCAT slave are:

- Init
- Pre-Operational
- Safe-Operational and
- Operational
- Boot (not supported)

After bootup each EtherCAT slave will be in state Op.

Init

Initial state of EtherCAT slave after switch on. There is neither mailbox nor process data communication. The SyncManager channels 0 and 1 for mailbox communication are being initialized by the EtherCAT master.

Pre-Operational (Pre-Op)

The EtherCAT slave will verify proper mailbox initialising when changing from Init to Pre-Op. Pre-Op enables mailbox communication but not process data communication. The EtherCAT master will initialize the SyncManager channels (up from 2) for the process data, the FMMU channels and PDO mapping or SyncManager PDO assignment, provided the slave supports configurable mapping.

Furthermore, the process data transmission settings as well as clamp-specific parameterization- other than default and where appropriate - are transmitted in Pre-Op state

Safe-Operational (Safe-Op)

Upon changing from Pre-Op to Safe-Op, the EtherCAT slave will verify whether the SyncManager channels for process data communication and the Distributed Clock settings are valid. Prior to confirming Safe-Op, the slave will copy the current input data into the related DP-RAM areas of the EtherCAT Slave Controller (ESC). In Safe-Op both mailbox and process data communication are enabled, however the slave will keep its outputs safe (not relevant to encoder). Cyclic update of input data.

Operational (Op)

Process data and mailbox communication is in Op state.
Cyclic update of input data.

Boot (for firmware update): not supported.

6. Terminal assignment and commissioning

6.1 Mechanical mounting

Shaft encoders

- Mount encoder housing by help of the mounting holes and three screws (square flange: 4 screws) provided at flange. Observe thread diameter and depth.
- There is an alternative mounting option in any angular position by eccentric fixings, see under accessories.
- Connect drive shaft and encoder shaft by using an appropriate coupling. The shaft ends must not touch each other. The coupling must equalize any shifts due to temperature as well as mechanical tolerances. Observe the maximum permitted axial or radial shaft load. For appropriate couplings please refer to accessories.
- Tighten the mounting screws firmly.

Hollow shaft encoder

- Clamping ring fixture
Prior to mounting the encoder open the clamping ring completely. Push encoder onto the drive shaft and tighten the clamping ring firmly.
- Encoder torque pin
Slide encoder onto the drive shaft and insert torque pin into the adjusting element provided by customer.
- Adjusting element with rubberized spring element
Push the encoder on to the drive shaft and insert the parallel pin into the mounted adjusting element (not supplied) (with rubberized spring element)
- Adjusting bracket
Push the encoder over the drive shaft. Insert the adjusting bracket into the rubberized spring element of the encoder and fasten the adjusting bracket on the contact surface (not supplied).
- Shoulder screw
Push the encoder over the drive shaft and insert the shoulder screw (not supplied) in the rubberized spring element of the encoder.
- Coupling spring
Mount the coupling spring with screws onto the fixing holes of the encoder housing.
Push the encoder over the drive shaft and fasten the coupling spring on the contact surface.

6.2 Electrical connection

Assignment – M12 connector

Follow also the instructions of the respective supplier.

- Press mating connector softly into the plug.
- Turn mating connector carefully until the code mark is interlocking the corresponding space provided by the plug. Insert bushing completely. Tighten the nut as far as possible.

Exchange bus cover

The bus cover is to be stored and transported whilst in the ESD bag only. The bus cover has to fit the case tightly and has to be firmly secured by screws.

Remove bus cover

- Unscrew both fixing screws of the bus cover.
- Loosen bus cover carefully and remove it in axial direction.

Plug on bus cover

- Plug the bus cover carefully onto the D-SUB plug of the basic encoder, then push it over the rubber seal.
Avoid the case getting wedged. The bus cover has to fit tightly the basic encoder.
- Tighten both fixing screws firmly and conformable.
- An optimized connection between encoder case and the braiding shield of the supply cable is only achieved by a complete and close fit of the bus cover onto the basic encoder (interlock).

6.2.1 Initialising under TwinCAT system manager

- The included XML file must be copied into the respective directory: ..\TwinCAT\Io\EtherCAT
- Start TwinCAT system manager
- Then proceed as described below.

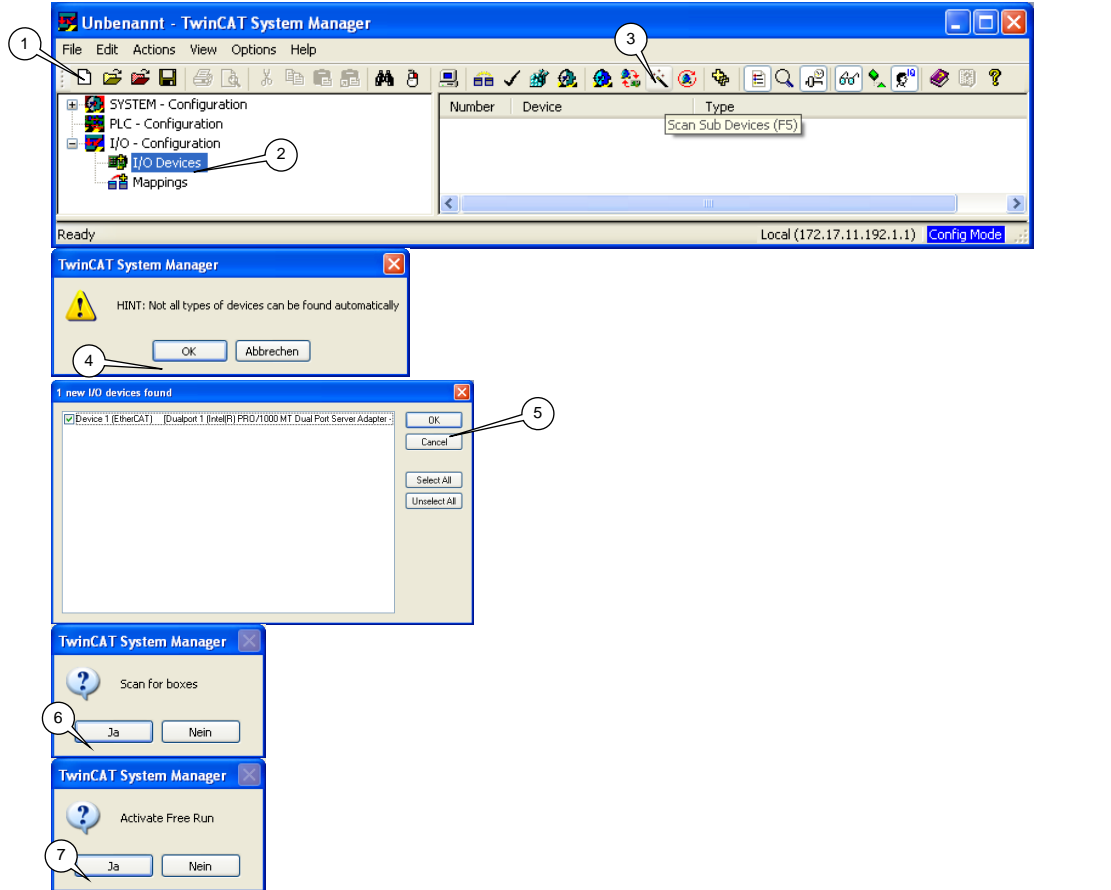

EtherCAT devices should appear like in screen below

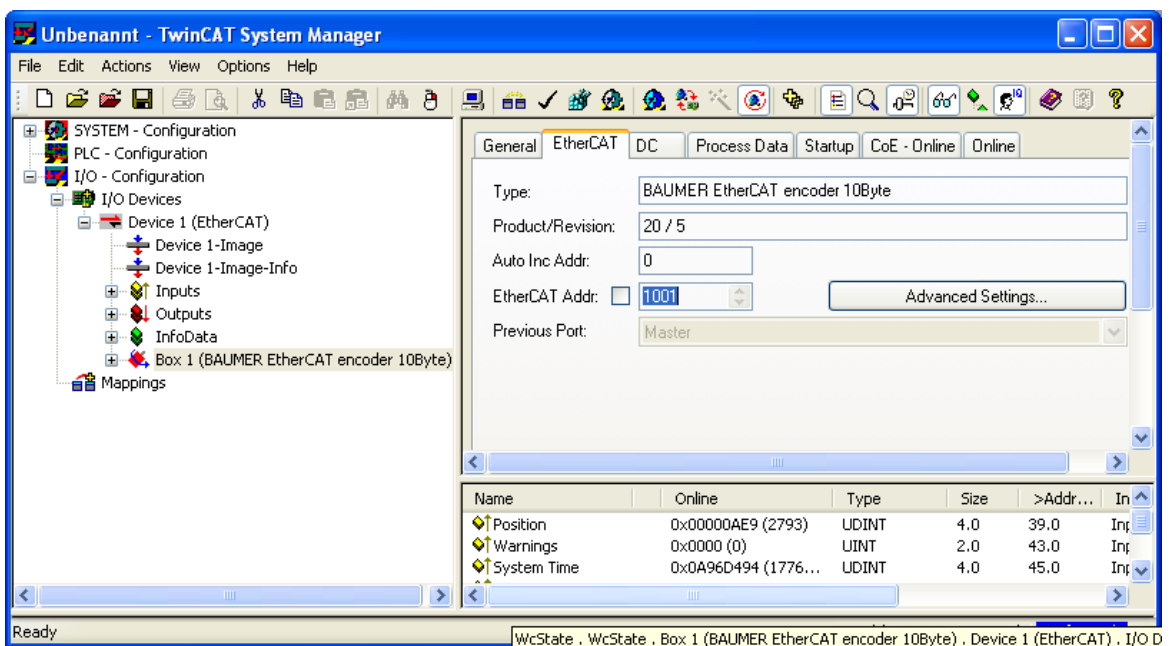

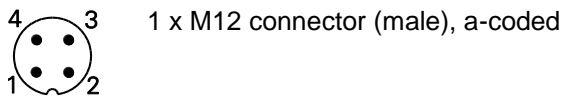
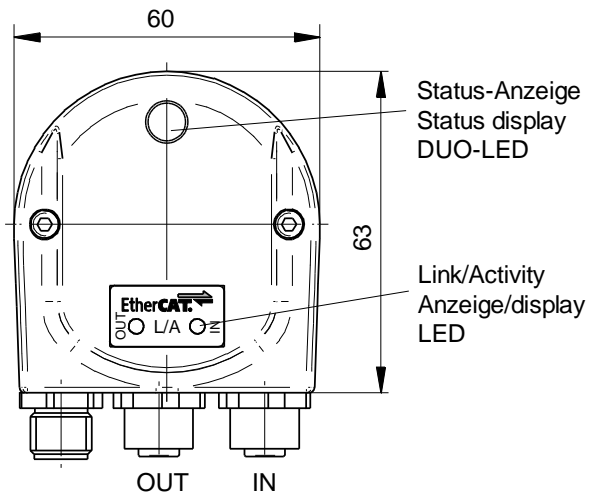
6.2.2 Terminal assignment
Bus cover shaft / blind hollow shaft - EtherCAT

Pin	Assignment
1	UB (10...30 VDC)
2	N.C.
3	GND
4	N.C.

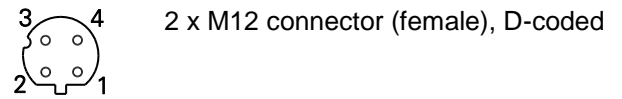

Pin	Assignment
1	TxD+
2	RxD+
3	TxD-
4	RxD-

6.3 Display elements

6.3.1 State indicator

The bus cover provides a DUO LED (green/red) operating in line with EtherCAT Indicator Specification V0.91.

DUO-LED green RUN State

RUN State	Status	Description	Category
Off	INIT	The device is in state INIT	Mandatory
Blinking	PRE-OPERATIONAL	The device is in state PRE-OPERATIONAL	Mandatory
Single Flash	SAFE-OPERATIONAL	The device is in state SAFE-OPERATIONAL	Mandatory
On	OPERATIONAL	The device is in state OPERATIONAL	Mandatory
Flickering	INITIALISATION or BOOTSTRAP	The device is booting and has not yet entered the INIT state, or the device is in state BOOTSTRAP. Firmware download operation in progress	Optional
Double Flash	Reserved	Reserved for future use	reserved
Triple Flash	Reserved	Reserved for future use	reserved
Quadruple	Reserved	Reserved for future use	reserved

DUO-LED red ERR State

ERR State	Error	Description	Example	Category
Off	No error	The EtherCAT communication of the device is in working condition		Mandatory
Flickering	Booting Error Booting	Error was detected. INIT state reached, but Parameter "Change" in the AL status register is set to 0x01:change error	Checksum Error in Flash Memory.	Optional
Blinking	Invalid Configuration	General Configuration Error	State change commanded by master is impossible due to register or object settings.	Mandatory
Single Flash	Unsolicited State Change	Slave device application has changed the EtherCAT state autonomously: Parameter "Change" in the AL status register is set to 0x01:change/error.	Synchronisation Error, device enters Safe-Operational automatically.	Mandatory
Double Flash	Application Watchdog Timeout	An application watchdog timeout has occurred.	Sync Manager Watchdog timeout	Mandatory
Triple Flash	Reserved	Reserved for future use		Reserved
Quadruple Flash	Reserved	Reserved for future use		Reserved
On	PDI Watchdog Timeout	A PDI Watchdog timeout has occurred	Application controller is not responding any more	Optional

6.3.2 Link/Activity indicator

One LED each for input and output.

Link	Activity	State of Link/Activity indicator
Yes	No	On
Yes	Yes	Flickering
No	Not applicable	Off

Note: All LED's are "off" if the encoder is under power supply but not yet connected to Ethernet.

6.4 Cycle times

Cycle times relate to the following settings:

- Basic encoder type
- Scaling on/off (0x6000 Bit 2²)
- Configuration 10 byte PDO/ 4 byte PDO/ 2 byte PDO

Scaling ON: 0x6000 2² =1; Scaling OFF: 0x6000 2² =0;

Chart on cycle times

All times in ns

10 Byte PDO (default)					
0x1C33:3 Shift time	0x1C33:5 Minimum cycle time		0x1C33:6 Calc and copy time		Basic encoder Device name
	Scaling OFF	Scaling ON	Scaling OFF	Scaling ON	
21300	214500	419500	188700	393700	GCAM
41800	234000	413000	185200	364200	GCMM
25000	217000	419000	183000	385000	GXAM
41000	233000	410000	183000	360000	GXMM
33600	228000	416000	185400	373400	GBAM
50600	245000	423000	185400	363400	GBMM

4 Byte PDO					
0x1C33:3 Shift time	0x1C33:5 Minimum cycle time		0x1C33:6 Calc and copy time		Basic encoder Device name
	Scaling OFF	Scaling ON	Scaling OFF	Scaling ON	
21300	74500	279500	48700	253700	GCAM
41800	92000	271000	43200	222200	GCMM
25000	76000	278000	42000	244000	GXAM
41000	92000	269000	42000	219000	GXMM
33600	86000	274000	43400	231400	GBAM
50600	104000	282000	44400	222400	GBMM

2 Byte PDO					
0x1C33:3 Shift time	0x1C33:5 Minimum cycle time		0x1C33:6 Calc and copy time		Basic encoder Device name
	Scaling OFF	Scaling ON	Scaling OFF	Scaling ON	
21300	62500	267500	36700	241700	GCAM
41800	85000	264000	36200	215200	GCMM
25000	68000	270000	34000	236000	GXAM
41000	84000	261000	34000	211000	GXMM
33600	78000	266000	35400	223400	GBAM
50600	96000	274000	36400	214400	GBMM

Note: Setting 2 byte PDO means input data will be limited to 2 bytes, no matter what the maximum total encoder resolution is.

6.5 Configuration 10 Byte PDO / 4 Byte PDO / 2 Byte PDO by TwinCAT

Default encoder configuration is 10 Byte PDO.

As an option, the encoder configuration may be changed to 4 Byte PDO or 2 Byte PDO to enable shorter cycle times where appropriate (see chapter cycle times).

Example: How to alter the 10 Byte PDO configuration (default) to 4 Byte PDO

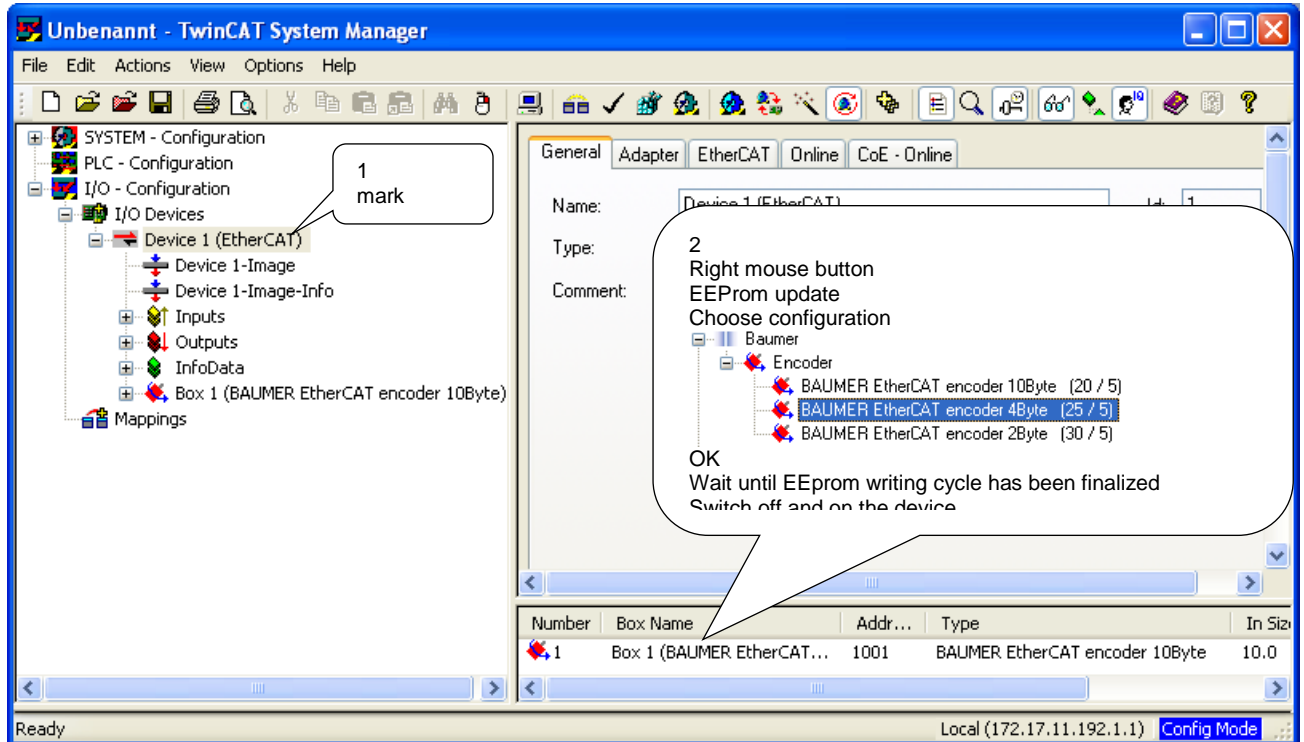

OFF/ON, File new, device search using F5

