



Device Information

Model Name	VCXG.2-241M.XC
Vendor Name	Baumer

Sensor Information

Sensor Name	Sony IMX540 Gen4
Type	1.2" progressive scan CMOS
Shutter	Global Shutter
Resolution	5312 x 4592 pixels
Scan Area	14.55 mm x 12.58 mm
Pixel Size	2.74 μm x 2.74 μm

Data Quality

@ 20 °C, gain = 1, exposure time = 4 msec

Dark Noise (σ)	2.3 e- typical
Saturation	9300 e- typical
Dynamic Range	70 dB typical
SNR	40 dB typical
Quantum efficiency η	70% @ 536 nm typical

Acquisition

Resolution	5312 px x 4592 px		
Interface Frame Rate (depends on used interface performance)	Format	Resolution	max. Frame Rate (@ Trigger Mode) ²⁾
	Full Frame	5312 x 4592	5 fps
	Binning 2x2	2656 x 2296	20 fps
	Binning 2x1	2656 x 4592	5 fps
	Binning 1x2	5312 x 2296	5 fps

Acquisition Frame Rate ¹⁾ (Burst Mode)	5 fps t _{readout} = 174 msec (max. Res. Full Frame) @ 10 bit
	5 fps t _{readout} = 174 msec (max. Res. Full Frame) @ 12 bit
	21 fps t _{readout} = 46 msec (max. Res. Binning 2x2) @ 10 bit
	21 fps t _{readout} = 46 msec (max. Res. Binning 2x2) @ 12 bit

Pixel Formats	Mono8, Mono10, Mono12, Mono12p
Partial Scan	True Partial Scan with increasing Frame Rate on Y direction, Region of Interest (ROI) arbitrary Width: minimum 32, increment 32 Height: minimum 1, increment 1
Adjustable Acquisition Frame Rate	Off or 0,01 ... 65535 Hz

Acquisition Mode	Continuous, Single Frame and Multi Frame
Acquisition Status	AcquisitionActive, AcquisitionTrigger Wait
Exposure Mode	Timed
Shutter Mode	Global
Readout Mode	Sequential

Image Pre-Processing

Analog Controls	Exposure Time (1 μsec ... 60 sec Step Size 1 μsec) Gain (0...48 dB), Offset (0 ... 255 LSB 12 bit)
Auto Function	ExposureAuto and GainAuto with BrightnessAutoPriority based on BrightnessAuto ROI
LUT	Luminance (12 bit)
Color Models	Mono
Color Processing	-
Color Adjustment	-

Sensor Graph: Relative Response

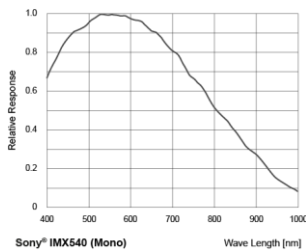

Sony® IMX540 (Mono)

Digital Output: High Active

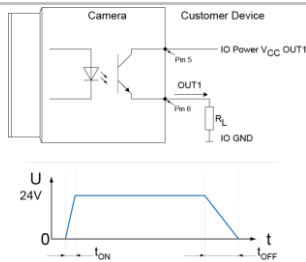

Digital Output: Low Active

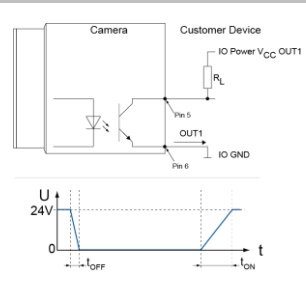

¹⁾ Sensor readout, different from pixel format

²⁾ depends on the used interface

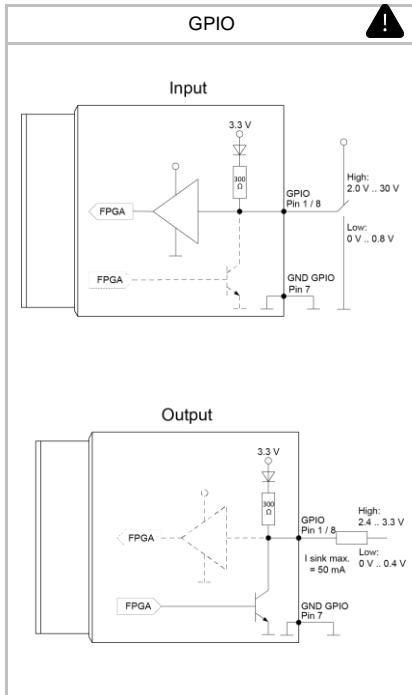
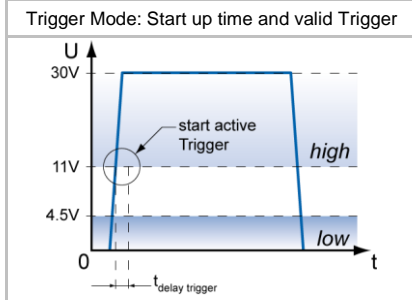
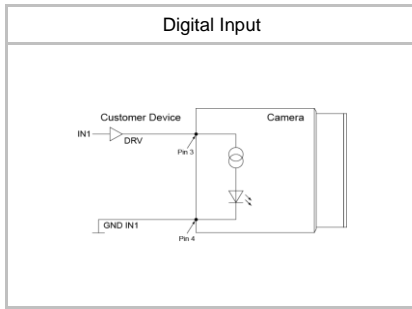

Image Pre-Processing

Color Enhancement	-
Color Tolerance	-
Binning Horizontal	1 or 2
Binning Vertical	1 or 2
Defect Pixel Correction	yes, static DPC: Defect Pixel List with up to 512 Pixel Coordinates
Image Flipping	Horizontal, vertical
Fix Pattern Noise Correction	-

Process Synchronization

Trigger Mode	Off (Free Running), On (Trigger)
Trigger Overlap Type	Readout
Trigger Sources	Hardware (Line0, 1, 2), Software, Counter 1, 2 End, Action CMD (Action 1), All or Off fixed Trigger Delay out of treadout: ¹⁾ 315 µsec @ 12 bit max. Trigger Delay during treadout: ¹⁾ 315 µsec @ 12 bit
Trigger Delay	0 ... 2 sec, Tracking and buffering of up to 256 triggers
External Flash Sync	via Exposure Active $t_{\text{delay flash}} \leq 3 \mu\text{sec}$, $t_{\text{duration}} = t_{\text{exposure}}$
Encoder Function	yes, via Counter and Trigger Source
PTP Function	-

Digital I/Os

Lines	Input: Line 0, Output: Line3, GPIO: Line 1, Line 2
Line Sources (Output)	Off, ExposureActive, Timer1, ReadoutActive, UserOutput 1-3 and TriggerReady
Line Debouncer (Input)	Low and high signal separately selectable Debouncing Time 0 ... 5 msec, Step Size: 1 µsec

Memory

Image Buffer	93,1 MB 2 Images (Trigger Mode) / 1 Image (Free Running Mode)
Non-volatile Memory	128 kb

Network Interface Data

Interface	Gigabit Ethernet 1000BASE-T 1000 Mb/s/sec Fast Ethernet 100 BASE-T 100 Mb/s/sec
Ethernet IP Configuration	Persistent IP, DHCP, LLA
Packet Size	576 ... 9000 Byte, Jumbo Frames supported

GigE Vision® Features

Events Transmission via Asynchronous Message Channel	DeviceTemperatureStatusChanged, EventLost, ExposureEnd, ExposureStart, FrameEnd, FrameStart, FrameTransferSkipped, GigEVisionError, GigEVisionHeartbeatTimeOut, PrimaryApplicationSwitch, Line0..2 FallingEdge, Line0..2 RisingEdge, TransferBufferFull, TransferBufferReady, TriggerOverlapped, TriggerReady, TriggerSkipped
Action CMD	yes, Action 1 for Trigger
Frame Counter	up to 2 ³²
Payload Size	0 ... 48785632 Byte
Timestamp	64 bit, resolution in nsec, increment = 8
Packet Delay	0 ... 2 ³² - 1 nsec
Packet Resend	Resend Buffer: 94 MB (2 Images)
GigE Vision	v2.0

¹⁾ Sensor readout, different from pixel format

LED Signalling

LED	LED 1	Yellow static - Error Yellow flash - TX active
	LED 2	Green static - Link ON Green flash - RX active

Electrical Data

Power Supply (ext.)	VCC: 12 ... 24 V DC \pm 20% I: 141 ... 283 mA
Power over Ethernet	Class 2 device VCC: 36 ... 57 V DC I: 86 mA @ 48 VDC
Power Consumption	approx. 3.4 W @ 12 VDC and 5 fps approx. 4.1 W @ 48 VDC (PoE) and 5 fps (Factory Setting "Default")
Digital Input	Optocoupler $U_{IN(low)}$: 0.0 ... 4.5 VDC $U_{IN(high)}$: 11.0 ... 30.0 VDC I_{IN} : 3.0 ... 10.0 mA min. Impulse Length: 2.0 μ sec
Digital Output	Optocoupler U_{EXT} : 5 ... 30 V DC I_{OUT} : max. 50 mA t_{ON} = typ. 3 μ sec t_{OFF} = typ. 40 μ sec
GPIO	direct, without optocoupler
GPIO used as Input:	$U_{IN(low)}$: 0.0 ... 0.8 VDC $U_{IN(high)}$: 2.0 ... 30.0 VDC min. Impulse Length: 2.0 μ sec
GPIO used as Output:	$U_{Out(low)}$: 0.0 ... 0.4 VDC ($I_{sink\ max}$: 50 mA) $U_{Out(high)}$: 2.4 ... 3.3VDC (I_{max} : 1 mA)
Caution 	* The General Purpose I/Os (GPIOs) are not potential-free and do not have an overrun cut-off. Incorrect wiring (overvoltage, undervoltage or voltage reversal) can lead to defects in the electronic system. Ground loops are to be avoided and can lead to destruction of the device.

Conformity

Conformity	CE, RoHS, REACH, UL Recognized
KC Registration No. / Date	- / -
MTBF	50 years @ T = 45 °C / 32 years @ T = 60 °C T = Measurement Point

GeniCam™ Features

Short Exposure Range	yes, ShortExposureTimeEnable Short Exposure Range 1 ... 3 μ sec - 39 μ sec ... 60 sec Default Exposure Range 39 μ sec ... 60 sec
Timer	Timer Selector: Timer 1 TimerTriggerSource: Line0, SoftwareTrigger, ExposureStart, ExposureEnd, FrameTransferSkipped, TriggerSkipped, Action 1 and Off TimerDelay: 0 μ sec ... 2 sec, Step Size: 1 μ sec TimerDuration: 4 μ sec ... 2 sec, Step Size: 1 μ sec
Counter	Counter Selector: Counter 1, Counter 2 CounterValue: 0 ... 65535 Counter Event Source: Counter1End or Counter2End, ExposureActive, FrameTransferSkipped, FrameTrigger, TriggerSkipped, Line0..2 and Off Counter Reset Source: Counter1End, Counter2End, Line0..2 and Off

GenICam™ Features

Sequencer	Sequencer Characteristics: up to 128 sets, up to 4 possible paths for triggered set transitions, 6 trigger sources: Counter1End, Counter2End, ExposureActive, Line0..2, ReadoutActive, Timer1End Sequencer Parameters for Exposure, Gain, Trigger, ROI and Output: ExposureTime, CounterDuration, CounterEventActivation, CounterEventSource, CounterResetSource, ExposureMode, ExposureTime, Gain, Height, OffsetX, OffsetY, TriggerMode, UserOutputValue, UserOutputValueAll, Width
User Sets	Factory Settings: UserSet0 (read only) Freely Programmable: UserSet1, UserSet2, UserSet3 Parameters: any user definable Parameter
Acquisition Abort	Delay up to 174 msec
Chunk Data	yes, Chunk Selector: Binning, BlackLevel, CounterValue, DeviceTemperature, ExposureTime, FrameID, Gain, Height, Image, ImageControl, LineStatusAll, OffsetX, OffsetY, PixelFormat, SequencerSetActive, Timestamp, Width
Device Temperature	InHouse Event generation, if temperature status changed from Normal to High, High to Exceeded and Exceeded to Normal Exceeded (no image transfer) = max. internal temperature sensor + 1 °C
Device Link Throughput Limit	yes, up to max. Device Link Speed
Custom Data	yes, 128 Byte with CustomDataKonfiguration Mode
Optical Black Pixel Area	-
Black Level Auto Adjust	-
Calibration Data	yes, camera calibration values can stored: CalibrationMatrix, CalibrationMatrixNew, CalibrationFocallenght, CalibrationAngularAperture, GeometryDistortionValue: k1, k2, p1, p2, k3, CalibrationVector: tvec, rvec and CalibrationDataVersion
SFNC Version	2.4.0

Factory Settings after Start-Up

Ethernet IP Configuration	DHCP, LLA
Trigger Mode	Off (Free Running)
Analog Controls	Exposure Time: 4 msec, Gain: 0 dB, Offset: 0
Pixel Format	Mono8
Partial Scan	Off
Acquisition Frame Rate	Off
Timer/Counter/Sequencer	Off
Defect Pixel Correction	On
Fixed Pattern Noise Correction	-
Optical Black Pixel Area	-
Black Level Auto Adjust	-
Digital Input	Line0, invert = false
Digital Output	Line3, invert = false, line source = Off
GPIO 1/2	Line1, Line2, invert = false, LineMode = Input
TriggerSource	All

Partial Scan @ FullFrame, min Exposure, Mono8 (monochrome camera) or BayerRG8 (color camera)

	Resolution	max. fps acquisition	max. fps interface ²⁾
HXGA	4096 x 3072	8	8
UHD (4K)	3840 x 2160	11	11
Full HD	1920 x 1080	22	22
SXGA	1280 x 1024	23	23
HD720	1280 x 720	32	32
XGA	1024 x 768	30	30
SVGA	800 x 600	37	37
VGA	640 x 480	46	46
CIF	352 x 288	68	68
QVGA	320 x 240	77	77
QCIF	176 x 144	107	107
HXGA	4096 x 3072	8	8
UHD (4K)	3840 x 2160	11	11
Full HD	1920 x 1080	22	22
SXGA	1280 x 1024	23	23
HD720	1280 x 720	32	32
XGA	1024 x 768	30	30
SVGA	800 x 600	37	37
VGA	640 x 480	46	46
CIF	352 x 288	68	68
QVGA	320 x 240	77	77
QCIF	176 x 144	107	107

²⁾ depends on the used interface