

IFRP 18P1501/S14

Inductive sensors special versions - pressure resistant

Article number: 10118745

Overview

- 2 mm
- PNP make function (NO)
- connector M12
- -25 ... 80 °C
- IP 68/67 (sensing face/sensor)



Picture similar



Technical data

General data

Mounting type	Flush
Special type	High pressure
Nominal sensing distance S _n	2 mm
Hysteresis	2 ... 20 % of S _r

Electrical data

Switching frequency	3 kHz
Voltage supply range +V _s	6 ... 30 VDC
Current consumption max. (no load)	12 mA
Output circuit	PNP make function (NO)
Voltage drop V _d	< 2 VDC
Output current	< 200 mA
Short circuit protection	Yes
Reverse polarity protection	Yes

Mechanical data

Type	Cylindrical threaded
Material (sensing face)	Ceramic
Housing material	Stainless steel
Peak pressure	1000 bar
Operating pressure static	< 500 bar
Operating pressure dynamic	< 350 bar
Dimension	18 mm
Housing length	60 mm
Connection types	Connector M12

Ambient conditions

Operating temperature	-25 ... +80 °C
Protection class	IP 68/67 (sensing face/sensor)

IFRP 18P1501/S14

Inductive sensors special versions - pressure resistant

Article number: 10118745

Dimension drawing

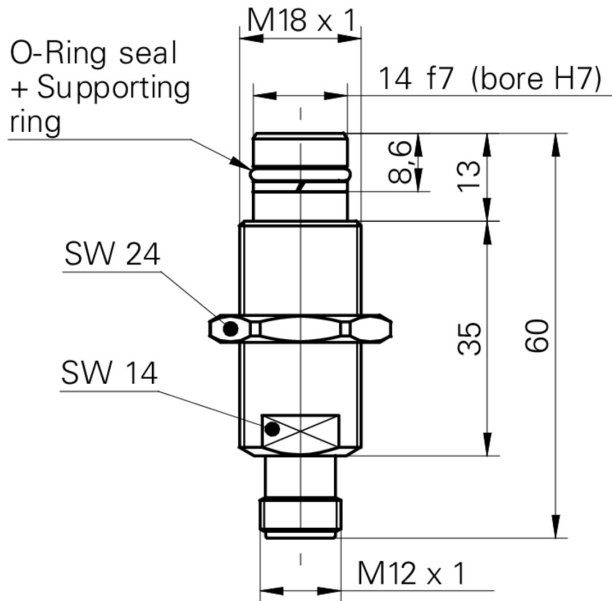

Installation drawing

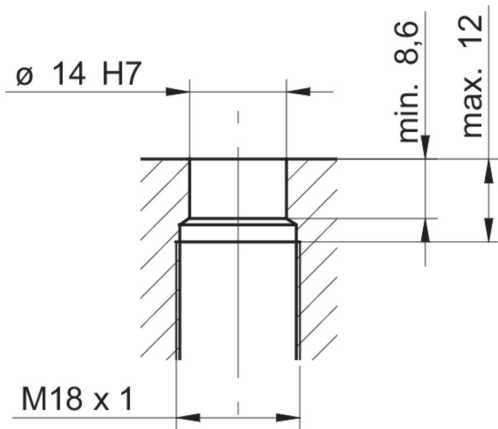

Connection diagram

