

Overview

- 2 mm
- PNP break function (NC)
- flylead connector M8
- -25 ... 75 °C
- IP 67



Picture similar



Technical data

General data

Mounting type	Flush
Nominal sensing distance S _n	2 mm
Hysteresis	3 ... 20 % of S _r
Output indicator	LED red

Electrical data

Switching frequency	5 kHz
Voltage supply range +V _s	6 ... 36 VDC
Current consumption max. (no load)	12 mA
Output circuit	PNP break function (NC)
Voltage drop V _d	< 2 VDC
Output current	< 200 mA

Electrical data

Short circuit protection	Yes
Reverse polarity protection	Yes

Mechanical data

Type	Cylindrical threaded
Material (sensing face)	PBT
Housing material	Stainless steel
Dimension	8 mm
Housing length	22 mm
Connection types	Flylead connector M8
Tightening torque max.	10 Nm (Front: 7 Nm)

Ambient conditions

Operating temperature	-25 ... +75 °C
Protection class	IP 67

Dimension drawing

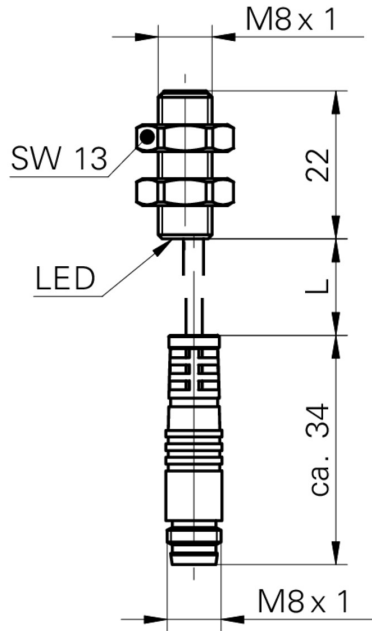

- Standard cable length 200 mm (L)

Connection diagram

