

Overview

- 2 mm
- NPN break function (NC)
- connector M8
- -25 ... 75 °C
- IP 67



Picture similar



Technical data

General data

Mounting type	Flush
Nominal sensing distance S _n	2 mm
Hysteresis	3 ... 20 % of S _r
Output indicator	3 port LED red

Electrical data

Switching frequency	5 kHz
Voltage supply range +V _s	6 ... 36 VDC
Current consumption max. (no load)	12 mA
Output circuit	NPN break function (NC)
Voltage drop V _d	< 2 VDC
Output current	< 200 mA

Electrical data

Short circuit protection	Yes
Reverse polarity protection	Yes

Mechanical data

Type	Cylindrical smooth
Material (sensing face)	PBT
Housing material	Stainless steel
Dimension	6.5 mm
Housing length	46 mm
Connection types	Connector M8

Ambient conditions

Operating temperature	-25 ... +75 °C
Protection class	IP 67

Remarks

- Robust steel housings
- High switching frequency

Dimension drawing

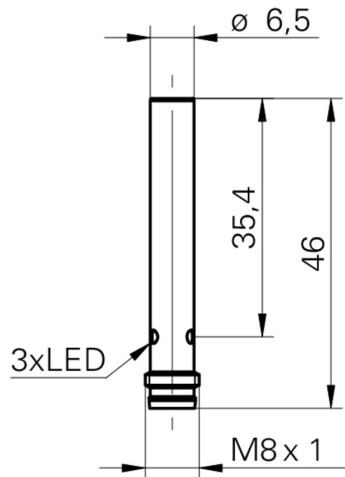

Connection diagram

