

Overview

- 1,6 mm
- PNP break function (NC)
- connector M8
- -25 ... 75 °C
- IP 67



Picture similar



Technical data

General data

Mounting type	Flush
Nominal sensing distance S _n	1.6 mm
Hysteresis	2 ... 20 % of S _r
Output indicator	3 port LED red

Electrical data

Switching frequency	3 kHz
Voltage supply range +V _s	6 ... 30 VDC
Current consumption max. (no load)	12 mA
Output circuit	PNP break function (NC)
Voltage drop V _d	< 2 VDC
Output current	< 200 mA

Electrical data

Short circuit protection	Yes
Reverse polarity protection	Yes

Mechanical data

Type	Cylindrical smooth
Material (sensing face)	LCP
Housing material	Stainless steel
Dimension	4 mm
Housing length	36 mm
Connection types	Connector M8

Ambient conditions

Operating temperature	-25 ... +75 °C
Protection class	IP 67

Remarks

- M8 x 1 quick disconnect
- 3 port LED

Dimension drawing

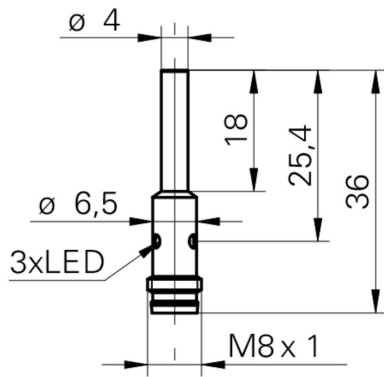

Connection diagram

