

User's Guide

VQXT cameras (10 Gigabit Ethernet)

Document Version: v1.4
Release: 07.12.2018
Document Number: 11192091

Table of Contents

1. General Information	8
2. General safety Instructions	10
3. Camera Models	11
3.1 VQXT	12
4. Installation	14
4.1 Environmental Requirements.....	14
4.2 Heat Transmission	14
4.3 Mechanical Tests.....	15
4.4 Lens mounting	16
4.5 Cleaning.....	16
5. Pin Assignment / LED-Signaling.....	17
5.1 Power and Process Interface.....	17
5.2 Data Interface	17
5.3 LED Signaling	18
6. Product Specifications	19
6.1 Spectral Sensitivity.....	19
6.2 Sensor position accuracy.....	20
6.3 Software.....	20
6.3.1 Baumer GAPI	20
6.3.2 3 rd Party Software	20
7. Camera Functions	21
7.1 AcquisitionControl	21
7.1.1 AcquisitionAbort.....	21
7.1.2 AcquisitionFrameRate	21
7.1.3 AcquisitionFrameRateEnable	22
7.1.4 AcquisitionFrameRateLimit.....	22
7.1.5 AcquisitionMode	22
7.1.6 AcquisitionStart.....	23
7.1.7 AcquisitionStatus	23
7.1.8 AcquisitionStatusSelector	23
7.1.9 AcquisitionStop	24
7.1.10 ExposureMode	24
7.1.11 ExposureTime.....	25
7.1.12 ReadoutMode	26
7.1.13 TriggerActivation.....	27
7.1.14 TriggerDelay	27
7.1.15 TriggerMode	27
7.1.16 TriggerOverlap.....	28
7.1.17 TriggerSelector	28
7.1.18 TriggerSoftware	28
7.1.19 TriggerSource	28
7.2 AnalogControl	29
7.2.1 BalanceWhiteAuto (only color cameras)	29

7.2.2	BlackLevel	29
7.2.3	BlackLevelSelector	29
7.2.4	Gain	30
7.2.5	GainSelector	30
7.3	ChunkDataControl	31
7.3.1	ChunkEnable	32
7.3.2	ChunkModeActive	33
7.3.3	ChunkSelector	33
7.4	CounterAndTimerControl	34
7.4.1	CounterDuration	34
7.4.2	CounterEventActivation	34
7.4.3	CounterEventSource	34
7.4.4	CounterReset	35
7.4.5	CounterResetActivation	35
7.4.6	CounterResetSource	35
7.4.7	CounterSelector	36
7.4.8	CounterValue	36
7.4.9	CounterValueAtReset	36
7.4.10	FrameCounter	37
7.4.11	TimerDelay	37
7.4.12	TimerDuration	37
7.4.13	TimerSelector	38
7.4.14	TimerTriggerActivation	38
7.4.15	TimerTriggerSource	38
7.4.16	TriggerCounterLatch	39
7.4.17	TriggerCounterLatchValue	39
7.4.18	TriggerCounterReset	39
7.5	DeviceControl	40
7.5.1	DeviceCharacterSet	40
7.5.2	DeviceEventChannelCount	40
7.5.3	DeviceFamilyName	40
7.5.4	DeviceFirmwareVersion	41
7.5.5	DeviceLinkCommandTimeout	41
7.5.6	DeviceLinkHeartbeatMode	41
7.5.7	DeviceLinkHeartbeatTimeout	41
7.5.8	DeviceLinkSelector	42
7.5.9	DeviceLinkSpeed	42
7.5.10	DeviceManufacturerInfo	42
7.5.11	DeviceModelName	43
7.5.12	DeviceRegistersEndianness	43
7.5.13	DeviceReset	43
7.5.14	DeviceResetToDeliveryState	44
7.5.15	DeviceSFNCVersionMajor	44
7.5.16	DeviceSFNCVersionMinor	44
7.5.17	DeviceSFNCVersionSubMinor	45
7.5.18	DeviceScanType	45
7.5.19	DeviceSensorType	45
7.5.20	DeviceSerialNumber	45
7.5.21	DeviceStreamChannelCount	46
7.5.22	DeviceStreamChannelEndianness	46
7.5.23	DeviceStreamChannelPacketSize	46
7.5.24	DeviceStreamChannelSelector	46
7.5.25	DeviceStreamChannelType	47
7.5.26	DeviceTLType	47
7.5.27	DeviceTLVersionMajor	47
7.5.28	DeviceTLVersionMinor	47
7.5.29	DeviceTLVersionSubMinor	48
7.5.30	DeviceTemperature	48
7.5.31	DeviceTemperatureSelector	48
7.5.32	DeviceType	48
7.5.33	DeviceUserID	49
7.5.34	DeviceVendorName	49
7.5.35	DeviceVersion	49

7.5.36	ReadOutTime	50
7.5.37	TimestampLatch	50
7.5.38	TimestampLatchValue	50
7.5.39	TimestampReset	51
7.6	DigitalIOControl	52
7.6.1	LineDebouncerHighTimeAbs	54
7.6.2	LineDebouncerLowTimeAbs	54
7.6.3	LineInverter	54
7.6.4	LineMode	54
7.6.5	LineSelector	55
7.6.6	LineSource	56
7.6.7	LineStatus	57
7.6.8	LineStatusAll	57
7.6.9	UserOutputSelector	57
7.6.10	UserOutputValue	58
7.6.11	UserOutputValueAll	58
7.7	EventControl	59
7.7.1	EventNotification	60
7.7.2	EventSelector	60
7.7.3	LostEventCounter	60
7.8	ImageFormatControl	61
7.8.1	BinningHorizontal	62
7.8.2	BinningHorizontalMode	62
7.8.3	BinningSelector	63
7.8.4	BinningVertical	63
7.8.5	BinningVerticalMode	63
7.8.6	Height	64
7.8.7	HeightMax	65
7.8.8	OffsetX	65
7.8.9	OffsetY	66
7.8.10	PixelFormat	67
7.8.11	ReverseX (only monochrome cameras)	67
7.8.12	ReverseY (only monochrome cameras)	68
7.8.13	SensorHeight	68
7.8.14	SensorWidth	68
7.8.15	TestPattern	69
7.8.16	TestPatternGeneratorSelector	69
7.8.17	Width	70
7.8.18	WidthMax	70
7.9	LUTControl	71
7.9.1	DefectPixelCorrection	73
7.9.2	DefectPixelListEntryActive	74
7.9.3	DefectPixelListEntryPosX	74
7.9.4	DefectPixelListEntryPosY	74
7.9.5	DefectPixelListIndex	74
7.9.6	DefectPixelListSelector	75
7.9.7	FixedPatternNoisocorrection	75
7.10	Memory Management	76
7.10.1	MemoryActivePart	80
7.10.2	MemoryFreeBlocks	80
7.10.3	MemoryMaxBlocks	80
7.10.4	MemoryMode	81
7.10.5	MemoryPartActiveBlock	82
7.10.6	MemoryPartBlocks	82
7.10.7	MemoryPartFilledBlocks	82
7.10.8	MemoryPartFreeBlocks	82
7.10.9	MemoryPartIncrementSoftware	83
7.10.10	MemoryPartIncrementSource	83
7.10.11	MemoryPartMode	83
7.10.12	MemoryPartPreviewRatio	84
7.10.13	MemoryPartSelector	84

7.11 SequencerControl	85
7.11.1 SequencerConfigurationMode	86
7.11.2 SequencerFeatureEnable	86
7.11.3 SequencerFeatureSelector	87
7.11.4 SequencerMode	87
7.11.5 SequencerPathSelector	88
7.11.6 SequencerSetActive	88
7.11.7 SequencerSetLoad	88
7.11.8 SequencerSetNext	88
7.11.9 SequencerSetSave	89
7.11.10 SequencerSetSelector	89
7.11.11 SequencerSetStart	89
7.11.12 SequencerTriggerActivation	90
7.11.13 SequencerTriggerSource	90
7.12 TransferControl	91
7.12.1 TransferControlMode	91
7.12.2 TransferOperationMode	91
7.12.3 TransferSelector	92
7.12.4 TransferStart	92
7.12.5 TransferStatus	92
7.12.6 TransferStatusSelector	93
7.12.7 TransferStop	93
7.13 TransportLayerControl	94
7.13.1 GigEVision	94
7.13.1.1 GVSPConfigurationBlockID64Bit	94
7.13.1.2 GevCCP	94
7.13.1.3 GevCurrentDefaultGateway	94
7.13.1.4 GevCurrentIPAddress	95
7.13.1.5 GevCurrentIPConfigurationDHCP	95
7.13.1.6 GevCurrentIPConfigurationLLA	95
7.13.1.7 GevCurrentIPConfigurationPersistentIP	96
7.13.1.8 GevCurrentSubnetMask	96
7.13.1.9 GevFirstURL	96
7.13.1.10 GevGVCPEExtendedStatusCodes	96
7.13.1.11 GevGVCPEExtendedStatusCodesSelector	97
7.13.1.12 GevGVCPPendingAck	97
7.13.1.13 GevIPConfigurationStatus	97
7.13.1.14 GevInterfaceSelector	98
7.13.1.15 GevMACAddress	98
7.13.1.16 GevMCDA	98
7.13.1.17 GevMCPHostPort	98
7.13.1.18 GevMCRC	99
7.13.1.19 GevMCSP	99
7.13.1.20 GevMCTT	99
7.13.1.21 GevNumberOfInterfaces	99
7.13.1.22 GevPAUSEFrameReception	100
7.13.1.23 GevPersistentDefaultGateway	100
7.13.1.24 GevPersistentIPAddress	100
7.13.1.25 GevPersistentSubnetMask	100
7.13.1.26 GevPrimaryApplicationIPAddress	101
7.13.1.27 GevPrimaryApplicationSocket	101
7.13.1.28 GevPrimaryApplicationSwitchoverKey	101
7.13.1.29 GevSCDA	101
7.13.1.30 GevSCFTD	102
7.13.1.31 GevSCPD	102
7.13.1.32 GevSCPHostPort	102
7.13.1.33 GevSCPIInterfaceIndex	102
7.13.1.34 GevSCPSDoNotFragment	103
7.13.1.35 GevSCPSFireTestPacket	103
7.13.1.36 GevSCPSPacketSize	103
7.13.1.37 GevSCSP	104
7.13.1.38 GevSondURL	104
7.13.1.39 GevStreamChannelSelector	104

7.13.1.40	GevSupportedOption.....	104
7.13.1.41	GevSupportedOptionSelector	105
7.13.2	PayloadSize	106
7.14	UserSetControl	107
7.14.1	UserSetDefault	107
7.14.2	UserSetFeatureEnable	108
7.14.3	UserSetFeatureSelector	108
7.14.4	UserSetLoad	109
7.14.5	UserSetSave	109
7.14.6	UserSetSelector	109
8.	Interface Functionalities	110
8.1	Device Information	110
8.2	Packet Size and Maximum Transmission Unit (MTU).....	110
8.3	Inter Packet Gap (IPG)	111
8.3.1	Example 1: Multi Camera Operation – Minimal IPG.....	111
8.3.2	Example 2: Multi Camera Operation – Optimal IPG.....	112
8.4	Frame Delay	113
8.4.1	Time Saving in Multi-Camera Operation	113
8.4.2	Configuration Example	114
8.5	Multicast.....	116
8.6	IP Configuration	117
8.6.1	Persistent IP	117
8.6.2	DHCP (Dynamic Host Configuration Protocol).....	117
8.6.3	LLA	118
8.6.4	Force IP	118
8.7	Packet Resend.....	119
8.7.1	Normal Case.....	119
8.7.2	Fault 1: Lost Packet within Data Stream	119
8.7.3	Fault 2: Lost Packet at the End of the Data Stream	120
8.7.4	Termination Conditions	120

1. General Information

Thanks for purchasing a camera of the Baumer family. This User's Guide describes how to connect, set up and use the camera.



Read this manual carefully and observe the notes and safety instructions!

Support

In case of any questions please contact our Technical & Application Support Center.

Worldwide: **Baumer Optronic GmbH**
Badstrasse 30
DE-01454 Radeberg, Germany

Tel: +49 (0)3528 4386 845

Website: www.baumer.com

E-mail: support.cameras@baumer.com

Target group for this User's Guide

This User's Guide is aimed at experienced users, which want to integrate camera(s) into a vision system.

Intended Use

The camera is used to capture images that can be transferred over a 10 Gigabit Ethernet interface to a PC.

Notice

Use the camera only for its intended purpose!

For any use that is not described in the technical documentation poses dangers and will void the warranty. The risk has to be borne solely by the unit's owner.

Classification of the safety instructions

In the User's Guide, the safety instructions are classified as follows:

Notice

Gives helpful notes on operation or other general recommendations.



Caution



Indicates a possibly dangerous situation. If the situation is not avoided, slight or minor injury could result or the device may be damaged.

Disposal



Dispose of outdated products with electrical or electronic circuits, not in the normal domestic waste, but rather according to your national law and the directives 2002/96/EC and 2006/66/EC for recycling within the competent collectors.

Through the proper disposal of obsolete equipment will help to save valuable resources and prevent possible adverse effects on human health and the environment.

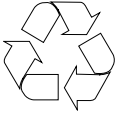

The return of the packaging to the material cycle helps conserve raw materials and reduces the production of waste. When no longer required, dispose of the packaging materials in accordance with the local regulations in force.

Keep the original packaging during the warranty period in order to be able to pack the device properly in the event of a warranty claim.

Warranty Notes

If it is obvious that the device is / was dismantled, reworked or repaired by other than Baumer technicians, Baumer Optronic will not take any responsibility for the subsequent performance and quality of the device!

Copyright

Any duplication or reprinting of this documentation, in whole or in part, and the reproduction of the illustrations even in modified form is permitted only with the written approval of Baumer. The information in this document is subject to change without notice.

2. General safety Instructions

Caution

Heat can damage the camera. Provide adequate dissipation of heat, to ensure that the temperature does not exceed the value (see Heat Transmission).



As there are numerous possibilities for installation, Baumer recommends no specific method for proper heat dissipation, but suggest the following principle:

- operate the cameras only in mounted condition with free air circulation
- mounting in combination with forced convection may provide proper heat dissipation

Caution



Observe precautions for handling electrostatic sensitive devices!

3. Camera Models

All Baumer cameras of these families are characterized by:

- | | |
|---------------------|---|
| High image quality | <ul style="list-style-type: none">▪ Global shutter architecture for minimized motion blur▪ Image data buffer for reliable image transmission |
| Fast image transfer | <ul style="list-style-type: none">▪ 10 Gigabit Ethernet▪ Reliable transmission up to 10000 Mbit/s |
| Perfect integration | <ul style="list-style-type: none">▪ Flexible generic programming interface (Baumer GAPI) for all Baumer cameras▪ Powerful Software Development Kit (SDK) with sample codes and help files for simple integration▪ Baumer Camera Explorer (Baumer GAPI Test Tool) for testing all camera functions▪ GenICam™ compliant XML file to describe the camera functions▪ Camera parameter programmable in real-time |
| Reliable operation | <ul style="list-style-type: none">▪ State-of-the-art camera electronics and precision mechanics▪ Very robust M12 connectors |
| Supported standards | <ul style="list-style-type: none">▪ GigE Vision® 2.0.0▪ GenICam SFNC 2.3.0 |

Conformity

CE We declare, under our sole responsibility, that the previously described Baumer cameras conform with the directives of the CE.



RoHS All Baumer cameras comply with the recommendation of the European Union concerning RoHS rules.



3.1 VQXT

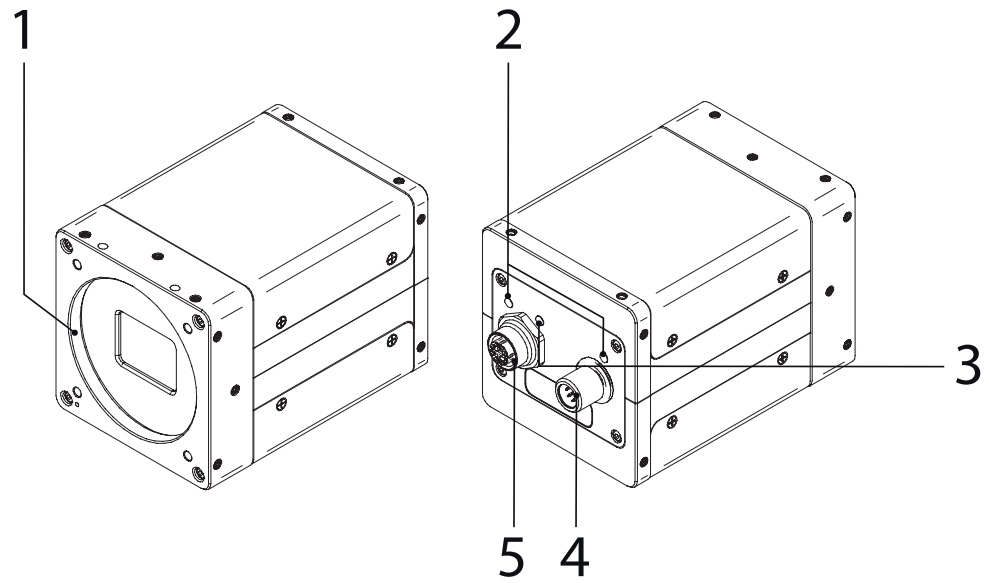

No.	Description	No.	Description
1	M58-mount	4	Power and process interface
2	GigE LED's	5	Data interface
3	Camera LED		

Camera Type	Sensor Size	Resolution	Full Frames ¹⁾ [max. fps]
Monochrome			
VQXT-120M.HS	APS-C	4096 × 3068	335 92
Color			
VQXT-120C.HS	APS-C	4096 × 3068	335 92

¹⁾ image acquisition in the camera's internal memory | interface (10 GigE)

Dimensions

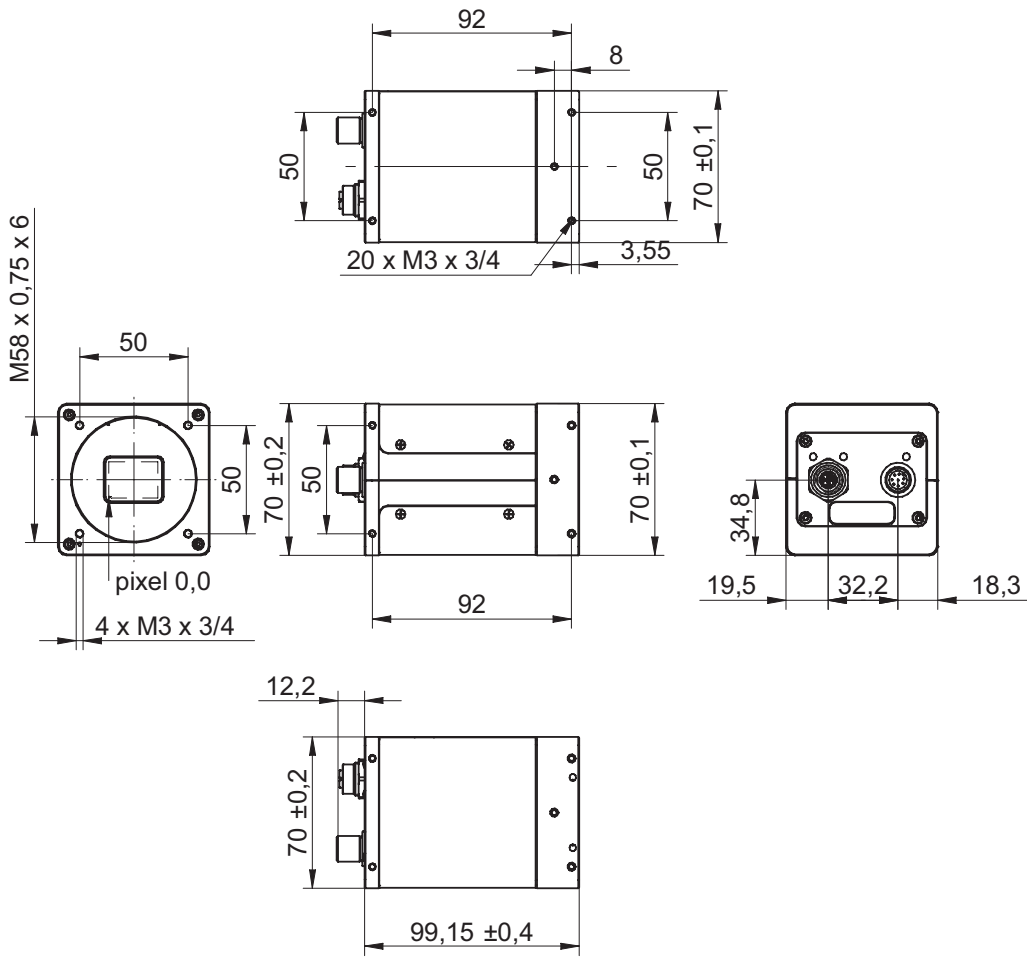

4. Installation

4.1 Environmental Requirements

Temperature	
Storage temperature	-10 °C ... +70 °C (+14 °F ... +158 °F)

Humidity	
Storage and operating humidity	10 % ... 90 % non-condensing

4.2 Heat Transmission

⚠ Caution

Heat can damage the camera. Provide adequate dissipation of heat, to ensure that the temperatures does not exceed the values on the table below.

As there are numerous possibilities for installation, Baumer recommends no specific method for proper heat dissipation, but suggest the following principle:



- operate the cameras only in mounted condition with free air circulation
- mounting in combination with forced convection may provide proper heat dissipation

Ambient temperature above 30 °C (+86 °F) requires heat dissipation measures!

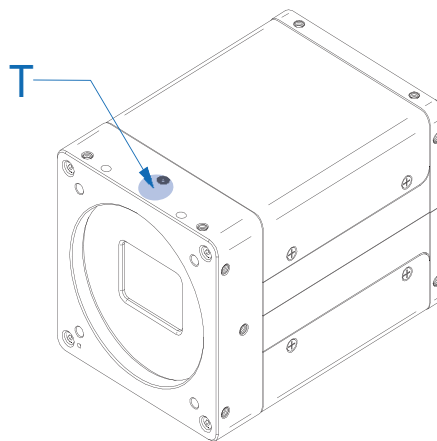

Measure Point	Maximal Temperature
T	+65 °C (149 °F)
internal Temperature Sensor	+75 °C (167 °F)

4.3 Mechanical Tests

Environmental Testing	Standard	Parameter	
Vibration, sinussodial	IEC 60068-2-6	Continuous oscillation	10-2000 Hz
		Amplitude underneath cross-over frequencies	0,75 mm
		Acceleration	1 g
		Test duration	150 min (axis) 450 min (total)
Vibration, broad band	IEC 60068-2-64	Frequency range	10-2000 Hz
		Acceleration	10 g
		Test duration	5 h (axis) 15 h (total)
Shock	IEC 60068-2-27	Puls time	11 ms / 6 ms
		Acceleration	50 g / 100 g
Bump	IEC60068-2-29	Pulse Time	2 ms
		Acceleration	100 g

4.4 Lens mounting

Notice

Avoid contamination of the sensor and the lens by dust and airborne particles when mounting the lens to the device!

Therefore the following points are very important:

- Install the camera in an environment that is as dust free as possible!
- Keep the dust cover (bag) on camera as long as possible!
- Hold the camera downwards with unprotected sensor.
- Avoid contact with any optical surface of the camera!

4.5 Cleaning

Avoid cleaning if possible. To prevent dust build-ups, follow the instructions under *Installation*.

The device requires cleaning if the recorded images resemble the following example. In order to test the camera, capture a homogenous image (test target could be a white sheet of paper).



Filter / Cover glass



Caution!



Use of compressed air during cleaning.
Compressed air may force dust into the camera.
Never use compressed air to clean the filter / cover glass!

Use a soft, lint free cloth dampened with a small amount of pure methanol to clean the filter glass.

Housing



Caution!



Use of volatile solvents for cleaning.
Volatile solvents can damage the surface of the camera.
Never use volatile solvents (benzene, thinner) for cleaning!

Use a soft, dry cloth to clean the surface of the camera housing. To remove persistent stains, use a soft cloth dampened with a small quantity of neutral detergent, then wipe dry.

5. Pin Assignment / LED-Signaling

5.1 Power and Process Interface

Power supply / Digital-IO

(SACC-CI-M12MS-8CON-SH TOR 32)

wire colors of the connecting cable* (ordered separately)

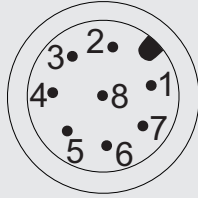

1	IN2 (Line1)	white	5	IO Power VCC	grey
2	Power VCC+	brown	6	OUT1 (Line2)	pink
3	IN1 (Line0)	green	7	GND (Power)	blue
4	GND I/O	yellow	8	OUT2 (Line3)	red

* shielded cable needs to be used

Power Supply

Power VCC	12 VDC ... 24 VDC ± 20 %
-----------	--------------------------

5.2 Data Interface

Notice

You can operate the camera on a GigE connection instead of a 10GigE connection. This reduces the performance.

Ethernet

(SACC-CI-M12FS-8CON-L180-10G)

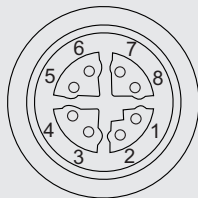

1	MX1+	5	MX4+
2	MX1-	6	MX4-
3	MX2+	7	MX3-
4	MX2-	8	MX3+

5.3 LED Signaling

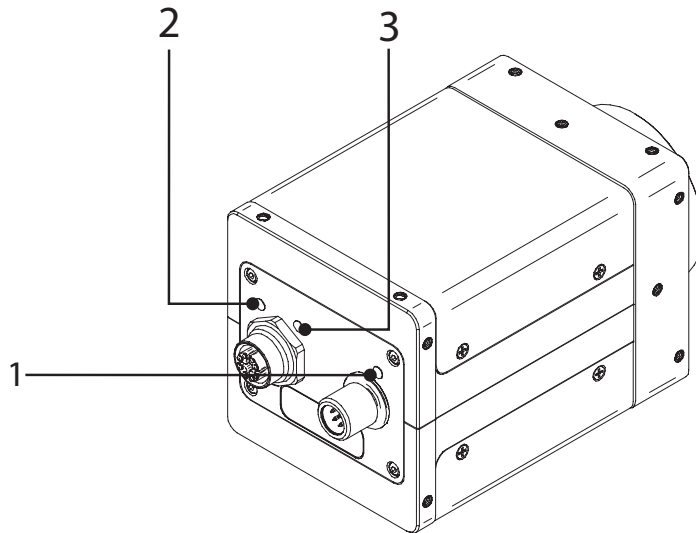

			Signal	Meaning
LED	1	GigE LED	Green On	Link 10 Gbit
			Green Blinking	Link 10 Gbit in EEE Mode
	2	GigE LED	Yellow On	Link 1 Gbit
			Yellow Blinking	Link 1 Gbit in EEE Mode
	3	Camera LED	Off	Power Off
			Green On	Power On, no Readout
			Blinking (green - yellow)	Readout active
			Red blinking	Update in progress (Don't switch off!)

6. Product Specifications

6.1 Spectral Sensitivity

The following graphs show the spectral sensitivity characteristics of the camera. The characteristic curves for the sensors do not take the characteristics of lenses and light sources without filters into consideration.

Values relating to the respective technical data sheets of the sensor.

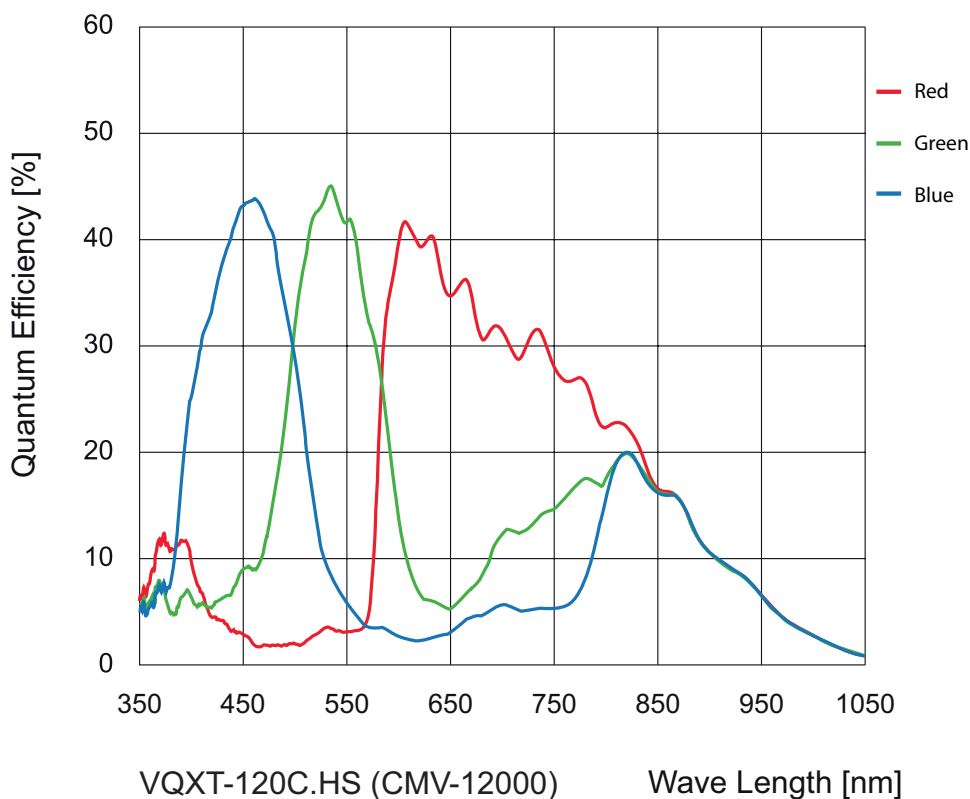
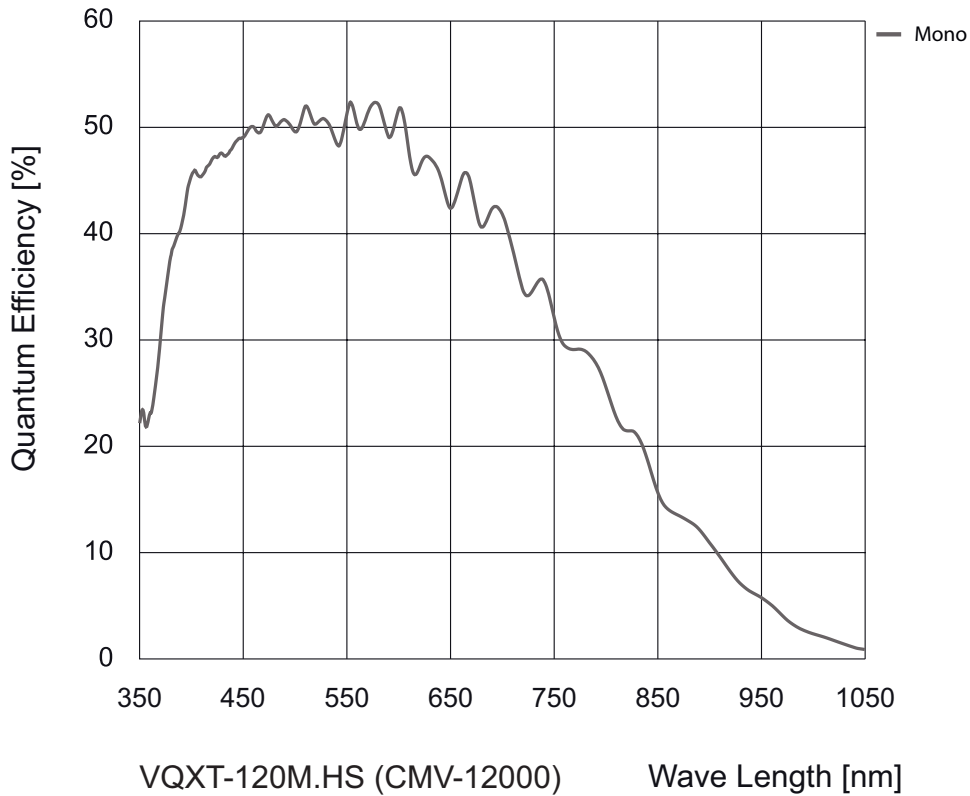

6.2 Sensor position accuracy

The typical accuracy by assumption of the root mean square value is displayed in the figures and the table below:

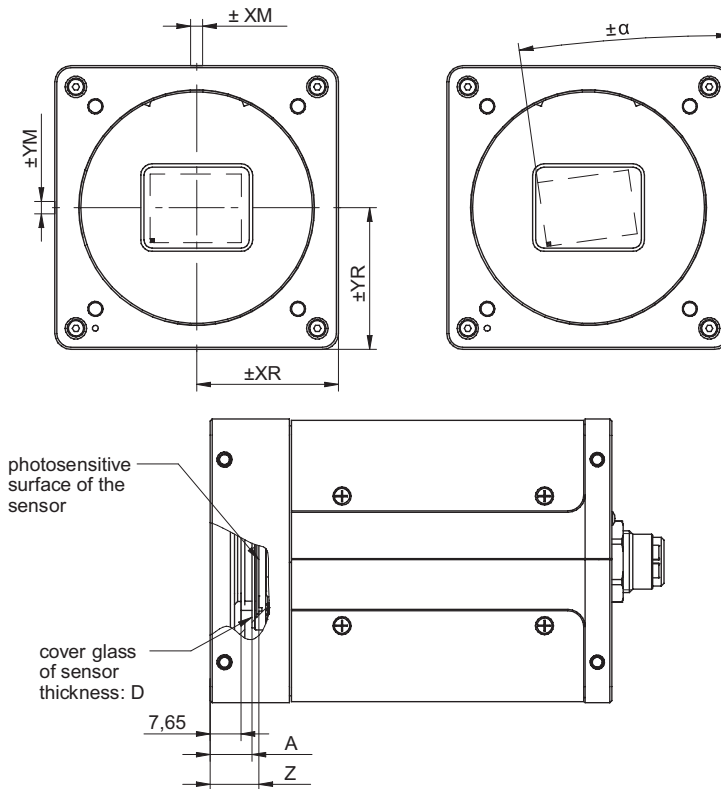

** Dimension D in this table is from manufacturer datasheet

typical accuracy by assumption of the root mean square value
* C or M

Camera Type	$\pm x_M$ [mm]	$\pm y_M$ [mm]	$\pm x_R$ [mm]	$\pm y_R$ [mm]	z_{typ} [mm]	$\pm \alpha_{typ}$ [°]	A [mm]	D** [mm]
VQXT-120*.HS	0.1	0.09	0.1	0.09	12 ± 0.3	0.2	10.3 ± 0.5	0.7 ± 0.5

** Dimension D in this table is from manufacturer datasheet

6.3 Software

6.3.1 Baumer GAPI

Baumer GAPI stands for **Baumer “Generic Application Programming Interface”**. With this API Baumer provides an interface for optimal integration and control of Baumer cameras. This software interface allows changing to other camera models.

It provides interfaces to several programming languages, such as C, C++ and the .NET™ Framework on Windows®, as well as Mono on Linux® operating systems, which offers the use of other languages, such as e.g. C# or VB.NET.

More information can be found at: <http://www.baumer.com/?id=8453>

6.3.2 3rd Party Software

Strict compliance with the GenICam™ standard allows Baumer to offer the use of 3rd Party Software for operation with cameras of this series.

You can find a current listing of 3rd Party Software, which was tested successfully in combination with Baumer cameras, at: <http://www.baumer.com/?id=8457>

7. Camera Functions

The description of the camera features is based on the GenICam™ compliant XML description file of the camera.

According to the GenICam™ GenTL SFNC standard, all the public features of a GenTL Producer must be included in the corresponding XML description file following the GenTL module hierarchy, and must use the SFNC name and interface type for those features should they exist. Other vendor-specific or specialized features not mapping to existing SNFC features can be included, but must be located in a vendor-specific namespace in the XML description file. They may also use a vendor-specific name.

With the GenTL SFNC, each feature included in a category. The category element defines in which group of features a particular feature will be located.

The category does not affect the functionality of the features, but is used by the GUIs to group the features when displaying them. The main purpose of this is to insure that the GUI can present features in a more organized way. The features within a category are sorted alphabetically.

7.1 AcquisitionControl

This chapter describes all features related to image acquisition, including the trigger and exposure control.

7.1.1 AcquisitionAbort

The acquisition abort process is a special case in which the current acquisition is stopped. If an exposure is running, the exposure is aborted immediately and the image is not read out.

Name	AcquisitionAbort
Category	AcquisitionControl
Interface	ICommand
Access	Write only
Unit	-
Values	-

7.1.2 AcquisitionFrameRate

Controls the acquisition rate (in Hertz) at which the frames are captured.

Name	AcquisitionFrameRate
Category	AcquisitionControl
Interface	IFloat
Access	Read / Write
Unit	Hz
Values	0.010000 - 27,027.027027 (Increment: 1.00)

7.1.3 AcquisitionFrameRateEnable

Enables the acquisition at the framerate specified by AcquisitionFrameRate.

Name	AcquisitionFrameRateEnable
Category	AcquisitionControl
Interface	IBoolean
Access	Read / Write
Unit	-
Values	true = 1 (On) false = 0 (Off)

7.1.4 AcquisitionFrameRateLimit

Returns the maximal acquisition rate (in Hertz) at which the frames are captured.

Name	AcquisitionFrameRateLimit
Category	AcquisitionControl
Interface	IFloat
Access	Read only
Unit	Hz Depends on set values
Values	<ul style="list-style-type: none">▪ <i>ExposureTime</i>▪ Region of Interest (<i>OffsetX / OffsetY / Width / Height</i>)

7.1.5 AcquisitionMode

Sets the acquisition mode of the device. It defines mainly the number of frames to capture during an acquisition and the way the acquisition stops.

Name	AcquisitionMode
Category	AcquisitionControl
Interface	IEnumeration
Access	Read / Write
Unit	-
Values	Continuous Frames are captured continuously without external events until stopped with the AcquisitionStop command.

7.1.6 AcquisitionStart

Once image acquisition has started, the camera processes the images in three steps:

- Determining the current set of image parameters
- Sensor exposure
- Readout from the sensor.

This process is then repeated until the camera is stopped.

Notice

Certain settings which affect the image format can only be adjusted if the camera is stopped.

This includes:

- Pixel Format
- Region of Interest (OffsetX / OffsetY / Width / Height)

Name	AcquisitionStart
Category	AcquisitionControl
Interface	ICommand
Access	Write only
Unit	-
Values	-

7.1.7 AcquisitionStatus

Reads the state of the internal acquisition signal selected using AcquisitionStatusSelector.

Name	AcquisitionStatus
Category	AcquisitionControl
Interface	IBoolean
Access	Read only
Unit	-
Values	true = 1 (On) false = 0 (Off)

7.1.8 AcquisitionStatusSelector

Selects the internal acquisition signal to read using AcquisitionStatus.

Name	AcquisitionStatusSelector
Category	AcquisitionControl
Interface	IEnumeration
Access	Read / Write
Unit	-
Values	Acquisition Active Device is currently doing an acquisition of one or many frames. Acquisition Trigger Wait Device is currently waiting for a trigger for the capture of one or many frames.

7.1.9 AcquisitionStop

Stops the Acquisition of the device at the end of the current Frame.

Name	AcquisitionStop
Category	AcquisitionControl
Interface	ICommand
Access	Write only
Unit	-
Values	-

7.1.10 ExposureMode

Sets the operation mode of the Exposure (or shutter).

Name	ExposureMode
Category	AcquisitionControl
Interface	IEnumeration
Access	Read / Write
Unit	-
Values	Timed Timed exposure. The exposure duration time is set using the ExposureTime or ExposureAuto features and the exposure starts with the FrameStart or LineStart.

7.1.11 ExposureTime

On exposure of the sensor, the inclination of photons produces a charge separation on the semiconductors of the pixels. This results in a voltage difference which is used to extract the signal.

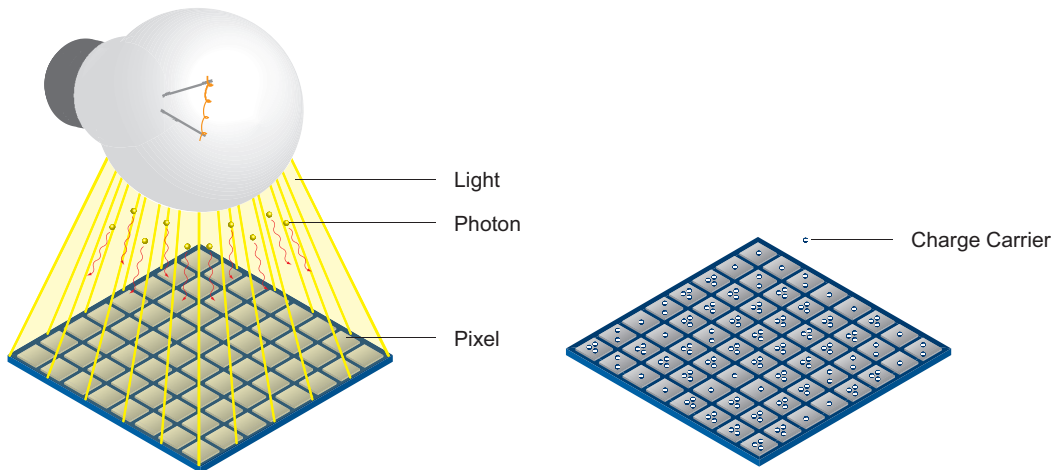

The signal strength is influenced by the incoming amount of photons. It can be increased by increasing the exposure time (t_{exposure}).

Name	ExposureTime
Category	AcquisitionControl
Interface	IFloat
Access	Read / Write
Unit	μs
Values	16.000000 - 1,000,000.000000 (Increment: 1.00)

7.1.12 ReadoutMode

Specifies the operation mode of the readout for the acquisition.

Image acquisition consists of two separate procedures carried out in succession.

Exposing the pixels on the photosensitive surface of the sensor is only the first part of the image acquisition process. Once this first step is completed, the pixels are read out.

The exposure time (t_{exposure}) can be adjusted by the user, however, the time needed for the readout (t_{readout}) is determined by the particular sensor and image format in use.

The cameras can be operated sequential or overlapped depending on the mode and the combination of exposure and readout times used:

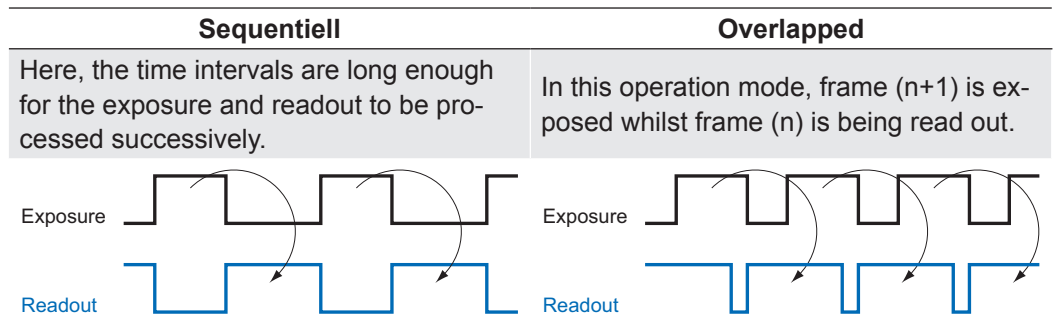

Name	ReadoutMode	
Category	AcquisitionControl	
Interface	IEnumeration	
Access	Read / Write	
Unit	-	
Values	Overlapped	Overlapped ReadOutMode
	Sequential	Sequential ReadoutMode

7.1.13 TriggerActivation

Specifies the activation mode of the trigger.

Name	TriggerActivation	
Category	AcquisitionControl	
Interface	IEnumeration	
Access	Read / Write	
Unit	-	
Values	FallingEdge	Specifies that the trigger is considered valid on the falling edge of the source signal.
	RisingEdge	Specifies that the trigger is considered valid on the rising edge of the source signal.

7.1.14 TriggerDelay

Specifies the delay in microseconds (us) to apply after the trigger reception before activating it.

Name	TriggerDelay
Category	AcquisitionControl
Interface	IFloat
Access	Read / Write
Unit	µs
Values	0 - 2,000,000.000000 (Increment: 1.00)

7.1.15 TriggerMode

Controls if the selected trigger is active.

Name	TriggerMode	
Category	AcquisitionControl	
Interface	IEnumeration	
Access	Read / Write	
Unit	-	
Values	Off	Disables the selected trigger.
	On	Enable the selected trigger.

7.1.16 TriggerOverlap

Specifies the type trigger overlap permitted with the previous frame.

Name	TriggerOverlap
Category	AcquisitionControl
Interface	IEnumeration
Access	Read / Write
Unit	-
Values	Read Out Trigger is accepted immediately after the exposure period..

7.1.17 TriggerSelector

Selects the type of trigger to configure.

Name	TriggerSelector
Category	AcquisitionControl
Interface	IEnumeration
Access	Read / Write
Unit	-
Values	Frame Start Selects the type of trigger to configure.

7.1.18 TriggerSoftware

Generates a internal trigger. *TriggerSource* must be set to Software.

Name	TriggerSoftware
Category	AcquisitionControl
Interface	ICommand
Access	Write only
Unit	-
Values	-

7.1.19 TriggerSource

Specifies the internal signal or physical input Line to use as the trigger source. The selected trigger must have its *TriggerMode* set to On.

Name	TriggerSource
Category	AcquisitionControl
Interface	IEnumeration
Access	Read / Write
Unit	-
Values	Line0 Specifies which physical line (or pin) and associated I/O control block to use as external source for the trigger signal.
	Off No trigger source is active.
	Software Specifies that the trigger source will be generated by software using the TriggerSoftware command.

7.2 AnalogControl

Features in this chapter describes how to influence the analog features of an image, such as gain, black level, brightness correction and gamma.

7.2.1 BalanceWhiteAuto (only color cameras)

Controls the mode for automatic white balancing between the color channels. The white balancing ratios are automatically adjusted.

Name	BalanceWhiteAuto	
Category	AnalogControl	
Interface	IEnumeration	
Access	Read / Write	
Unit	-	
Values	Continuous	White balancing is constantly adjusted by the device.
	Off	White balancing is off.
	Once	White balancing is automatically adjusted once by the device. Once it has converged, it automatically returns to the Off state.

7.2.2 BlackLevel

Controls the analog black level as an absolute physical value. This represents a DC offset applied to the video signal.

Name	BlackLevel
Category	AnalogControl
Interface	IFloat
Access	Read / Write
Unit	-
Values	0 ... 31 (Increment: 1.00)

7.2.3 BlackLevelSelector

Selects which Black Level is controlled by the various Black Level features.

Name	BlackLevelSelector	
Category	AnalogControl	
Interface	IEnumeration	
Access	Read / Write	
Unit	-	
Values	All	Black Level will be applied to all channels or taps.

7.2.4 Gain

Motion blur is unacceptable in high quality image acquisition. Exposure times are therefore limited. However, this results in low output signals from the camera and dark images. To solve this issue, the signals can be amplified by a user-defined gain factor within the camera.

Notice

Increasing the gain factor also increases image noise.

Controls the selected gain as an absolute physical value.

Name	Gain
Category	AnalogControl
Interface	IIFloat
Access	Read / Write
Unit	-
Values	1 ... 4 (Increment: 0.10)

7.2.5 GainSelector

Selects which gain is controlled by the various gain feature.

Name	GainSelector	
Category	AnalogControl	
Interface	IEnumeration	
Access	Read / Write	
Unit	-	
Values	All	Gain will be applied to all channels or taps.
	Blue	Gain will be applied to the blue channel. (only color cameras)
	GreenBlue	Gain will be applied to the green blue channel. (only color cameras)
	GreenRed	Gain will be applied to the green red channel. (only color cameras)
	Red	Gain will be applied to the red channel. (only color cameras)

7.3 ChunkDataControl

The chunk is a data packet that is generated by the camera and integrated into the payload (every image), if chunk mode is activated. These data include different settings for the respective image. This integrated data packet contains different image settings. Baumer GAPI can read the Image Info Header (Chunk).

There are three Chunk modes:

Image Data

Only the image data are transferred, no Chunk data.

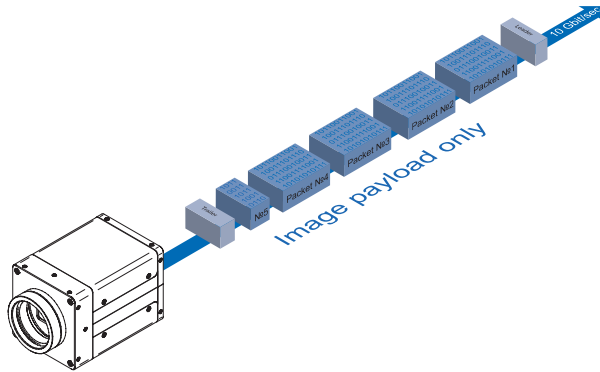

Chunk Data

Only the chunk is transferred, no image data.

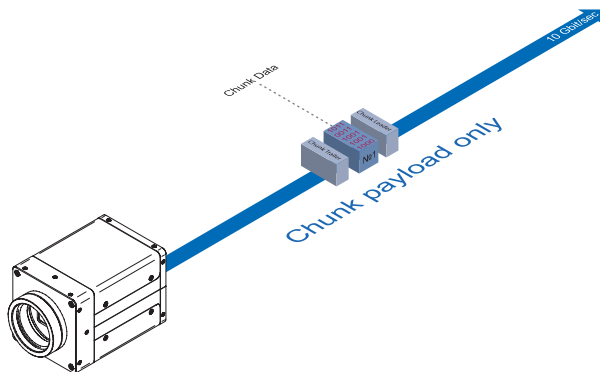

Extended Chunk Data

Chunk data and image data are transferred. The Chunk Data are included in the last data packet.

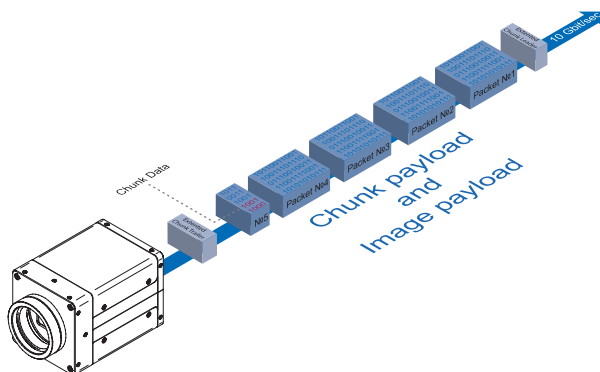

These settings are:

Feature	Description
BlackLevel	Returns the black level used to capture the image included in the payload.
DeviceTemperature	Device temperature in degrees Celsius (C). It is measured at the location selected by DeviceTemperatureSelector.
ExposureTime	Returns the exposure time used to capture the image.
FrameID	Returns the unique Identifier of the frame (or image) included in the payload.
Gain	Returns the gain used to capture the image.
Height	Returns the height of the image included in the payload.
Image	Transmits the Image data in chunk block.
ImageControl (subordinate features only together selectable)	
DefectPixelCorrection	On/Off the correction of defect pixels.
FixedPatternNoise	On/ Off the Fixed pattern noise correction.
ReverseX	On/Off Flip horizontally the image sent by the device. The Region of interest is applied after the flipping.
ReverseY	On/Off Flip vertically the image sent by the device. The Region of interest is applied after the flipping.
OffsetX	Horizontal offset from the origin to the area of interest (in pixels).
OffsetY	Vertical offset from the origin to the area of interest (in pixels).
PixelFormat	Returns the pixel format of the image included in the payload.
Timestamp	Returns the Timestamp of the image included in the payload at the time of the FrameStart internal event.
Trigger ID	ID of the Trigger.
Width	Returns the width of the image included in the payload.

7.3.1 ChunkEnable

Enables the inclusion of the selected chunk data in the payload of the image.

Notice

You can choose the desired chunk under *Chunk Selector*.

Notice

The camera must be stopped before feature can be edited.

Name	ChunkEnable
Category	ChunkDataControl
Interface	IBoolean
Access	Read / Write
Unit	-
Values	true = 1 (On) false = 0 (Off)

7.3.2 ChunkModeActive

Activation the includes of chunk data in the payload of the image.

Notice

The camera must be stopped before feature can be edited.

Name	ChunkModeActive
Category	ChunkDataControl
Interface	IBoolean
Access	Read / Write
Unit	-
Values	true = 1 (On) false = 0 (Off)

7.3.3 ChunkSelector

Selects which chunk to enable or controlled.

Name	ChunkSelector
Category	ChunkDataControl
Interface	IEnumeration
Access	Read / Write
Unit	-
Values	BlackLevel Device Temperature Exposure Time Frame ID Gain Height Image Image Control Line Status All Offset X Offset Y Pixel Format Timestamp Trigger ID Width

7.4 CounterAndTimerControl

This chapter lists all features that relates to control and monitoring of Counters and Timers.

7.4.1 CounterDuration

Sets the duration (or number of events) before the CounterEnd event is generated.

When the counter reaches the CounterDuration value, a CounterEnd event is generated, the CounterActive signal becomes inactive and the counter stops counting until a new trigger happens or it is explicitly reset with CounterReset.

Name	CounterDuration
Category	CounterAndTimerControl
Interface	Integer
Access	Read / Write
Unit	-
Values	0 ... 65535 (Increment: 1)

7.4.2 CounterEventActivation

Selects the Activation mode Event Source signal.

Name	CounterEventActivation	
Category	CounterAndTimerControl	
Interface	IEumeration	
Access	Read / Write	
Unit	-	
Values	RisingEdge	Counts on the Rising Edge of the signal.
	FallingEdge	Counts on the Falling Edge of the signal.
	AnyEdge	Counts on the Falling or rising Edge of the selected signal.

7.4.3 CounterEventSource

Selects the signals that will be the source to reset the Counter.

Name	CounterEventSource	
Category	CounterAndTimerControl	
Interface	IEumeration	
Access	Read / Write	
Unit	-	
Values	Counter2End	Counts the number of Counter End.
	ExposureActive	Counts all Exposures.
	FrameTrigger	Counts the number of Frame Start Trigger.
	Off	Disable the Counter Reset trigger.
	TriggerSkipped	Counts when a Trigger skipped.

7.4.4 CounterReset

Does a software reset of the selected Counter and starts it. The counter starts counting events immediately after the reset unless a Counter trigger is active. CounterReset can be used to reset the Counter independently from the CounterResetSource. To disable the counter temporarily, set CounterEventSource to Off.

Notice

Note that the value of the Counter at time of reset is automatically latched and reflected in the *CounterValueAtReset*.

Name	CounterReset
Category	CounterAndTimerControl
Interface	ICommand
Access	Write only
Unit	-
Values	-

7.4.5 CounterResetActivation

Selects the Activation mode of the Counter Reset Source signal.

Name	CounterResetActivation	
Category	CounterAndTimerControl	
Interface	IEumeration	
Access	Read / Write	
Unit	-	
Values	RisingEdge	Resets the counter on the Rising Edge of the signal.
	FallingEdge	Resets the counter on the Falling Edge of the signal.
	AnyEdge	Resets the counter on the Falling or rising Edge of the selected signal.

7.4.6 CounterResetSource

Selects the signals that will be the source to reset the Counter.

Name	CounterResetSource	
Category	CounterAndTimerControl	
Interface	IEumeration	
Access	Read / Write	
Unit	-	
Values	Counter1End	Resets with the reception of the Counter End.
	Counter2End	Resets with the reception of the Counter End.
	Line0	Resets by the chosen I/O Line.
	Off	Disable the Counter Reset trigger.

7.4.7 CounterSelector

Selects which Counter to configure.

Name	CounterSelector	
Category	CounterAndTimerControl	
Interface	IEumeration	
Access	Read / Write	
Unit	-	
Values	Counter1	Selects the counter 1.
	Counter2	Selects the counter 2.

7.4.8 CounterValue

Reads or writes the current value of the selected Counter. Writing to CounterValue is typically used to set the start value.

Name	CounterValue
Category	CounterAndTimerControl
Interface	IInteger
Access	Read / Write
Unit	-
Values	0 ... 65535 (Increment: 1)

7.4.9 CounterValueAtReset

Reads the value of the selected Counter when it was reset by a trigger or by an explicit CounterReset command.

It represents the last counter value latched before resetting the counter.

Name	CounterValueAtReset
Category	CounterAndTimerControl
Interface	IInteger
Access	Read only
Unit	-
Values	0 ... 65535 (Increment: 1)

7.4.10 FrameCounter

The FrameCounter is part of the Baumer Image Info Header (chunk) and is added to every image if chunk mode is activated. It is generated by the hardware and can be used to verify that each of the camera's images is transmitted to the PC and received in the right order.

It is possible to set the Frame Counter to a specific value by write this value to the Frame Counter.

Name	FrameCounter
Category	CounterAndTimerControl
Interface	IInteger
Access	Read / Write
Unit	-
Values	0 ... 9223372036854775807

7.4.11 TimerDelay

Sets the duration (in microseconds) of the delay to apply at the reception of a trigger before starting the Timer.

Name	TimerDelay
Category	CounterAndTimer
Interface	IFloat
Access	Read / Write
Unit	µs
Values	0 ... 2,000,000.000000 (Increment: 1.00)

7.4.12 TimerDuration

Sets the duration (in microseconds) of the Timer pulse.

Name	TimerDuration
Category	CounterAndTimer
Interface	IFloat
Access	Read / Write
Unit	µs
Values	10.000000 ... 2,000,000.000000 (Increment: 1.00)

7.4.13 TimerSelector

Selects which Timer to configure.

Name	TimerSelector	
Category	CounterAndTimerControl	
Interface	IEumeration	
Access	Read / Write	
Unit	-	
Values	Timer1	Selects the Timer 1.
	Timer2	Selects the Timer 2.
	Timer3	Selects the Timer 3.

7.4.14 TimerTriggerActivation

Selects the activation mode of the trigger to start the Timer.

Name	TimerTriggerActivation	
Category	CounterAndTimerControl	
Interface	IEumeration	
Access	Read / Write	
Unit	-	
Values	RisingEdge	Starts counting on the Rising Edge of the selected trigger signal.
	FallingEdge	Starts counting on the Falling Edge of the selected trigger signal.
	AnyEdge	Starts counting on the Falling or Rising Edge of the selected trigger signal.

7.4.15 TimerTriggerSource

Selects the source of the trigger to start the Timer.

Name	TimerTriggerSource	
Category	CounterAndTimerControl	
Interface	IEumeration	
Access	Read / Write	
Unit	-	
Values	ExposureEnd	Starts with the reception of the Exposure End.
	ExposureStart	Starts with the reception of the Exposure Start.
	FrameStart	Starts with the reception of the Frame Start.
	Line0	Starts when the specified TimerTriggerActivation condition is met on the chosen I/O Line.
	Off	Disables the Timer trigger.
	Software	Starts when the trigger was generated by the software.
	TriggerSkipped	Starts when a trigger was skipped.

7.4.16 TriggerCounterLatch

Latches the current trigger counter into TriggerCounterLatchValue.

Name	TriggerCounterLatch
Category	CounterAndTimerControl
Interface	ICommand
Access	Write only
Unit	-
Values	-

7.4.17 TriggerCounterLatchValue

Returns the latched value of the trigger counter.

Name	TriggerCounterLatch
Category	CounterAndTimerControl
Interface	IInteger
Access	Read only
Unit	-
Values	0 ... 9223372036854775807 (Increment: 8)

7.4.18 TriggerCounterReset

Resets the current value of the device trigger counter.

Name	TriggerCounterReset
Category	CounterAndTimerControl
Interface	ICommand
Access	Write only
Unit	-
Values	-

7.5 DeviceControl

Device control features provides general information and control for the device and its sensor.

7.5.1 DeviceCharacterSet

Character set used by the strings of the device`s bootstrap registers.

Name	DeviceCharacterSet
Category	DeviceControl
Interface	IEnumeration
Access	Read only
Unit	-
Values	UTF8 Device use UTF8 character set.

7.5.2 DeviceEventChannelCount

Indicates the number of event channels supported by the device.

Name	DeviceEventChannelCount
Category	DeviceControl
Interface	IInteger
Access	Read only
Unit	-
Values	0 ... 4294967295 (Increment: 1)

7.5.3 DeviceFamilyName

Identifier of the product family of the device.

Name	DeviceFamilyName
Category	DeviceControl
Interface	IString
Access	Read only
Unit	-
Values	device family name

7.5.4 DeviceFirmwareVersion

Version of the firmware in the device.

Name	DeviceFirmwareVersion
Category	DeviceControl
Interface	IString
Access	Read only
Unit	-
Values	e.g. CID:000291/PID:11170706

7.5.5 DeviceLinkCommandTimeout

Indicates the current command timeout of the specific Link.

Name	DeviceLinkCommandTimeout
Category	DeviceControl
Interface	IFloat
Access	Read only
Unit	µs
Values	300,000.000000

7.5.6 DeviceLinkHeartbeatMode

Activate or deactivate the Link's heartbeat.

Name	DeviceLinkHeartbeatMode
Category	DeviceControl
Interface	IEnumeration
Access	Read / Write
Unit	-
Values	On Enables the Link heartbeat. Off Disables the Link heartbeat.

7.5.7 DeviceLinkHeartbeatTimeout

Controls the current heartbeat timeout of the specific Link.

Name	DeviceLinkHeartbeatTimeout
Category	DeviceControl
Interface	IFloat
Access	Read / Write
Unit	µs
Values	500,000.000000 ... 4,294,967,295,000.000000 (Increment: 1)

7.5.8 DeviceLinkSelector

Selects which Link of the device to control.

Generally, a device has only one Link that can be composed of one or many connections. But if there are many, this selector can be used to target a particular Link of the device with certain features.

Name	DeviceLinkSelector
Category	DeviceControl
Interface	Integer
Access	Read / Write
Unit	-
Values	0 ... (Increment: 1)

7.5.9 DeviceLinkSpeed

Indicates the speed of transmission negotiated on the specified link.

Name	DeviceLinkSpeed
Category	DeviceControl
Interface	Integer
Access	Read only
Unit	Bps
Values	0 ... 9223372036854775807

7.5.10 DeviceManufacturerInfo

Manufacturer information about the device.

The content might look as follows:

Firmware (F) / FPGA (C) / BL3-Version (BL)

Name	DeviceManufacturerInfo
Category	DeviceControl
Interface	IString
Access	Read only
Unit	-
Values	e. g. F:00007F9A/C:0180802D/BL3.8:00000081

7.5.11 DeviceModelName

Model of the device.

Name	DeviceModelName
Category	DeviceControl
Interface	IString
Access	Read only
Unit	-
Values	e.g. VQXT-120C.HS

7.5.12 DeviceRegistersEndiannes

Endianness of the register of the device.

Name	DeviceRegistersEndianness
Category	DeviceControl
Interface	IEnumeration
Access	Read only
Unit	-
Values	Big Device registers are big Endian.

7.5.13 DeviceReset

The Device Reset feature corresponds with the camera's switched on and switched off states. Using this means it is no longer necessary to disconnect the power supply.

Notice

The execution of this feature may take several seconds.

Name	DeviceReset
Category	DeviceControl
Interface	ICommand
Access	Write only
Unit	-
Values	-

7.5.14 DeviceResetToDeliveryState

By executing this feature, the camera is set to the factory settings. The settings stored in the camera (e.g. *UserSets*) will be lost.

Notice

The execution of this feature takes less time than executing the feature *DeviceReset*.

Name	DeviceResetToDeliveryState
Category	DeviceControl
Interface	ICommand
Access	Write only
Unit	-
Values	-

7.5.15 DeviceSFNCVersionMajor

Major version of the Standard Features Naming Convention that was used to create the device's GenICam XML.

Name	DeviceSFNCVersionMajor
Category	DeviceControl
Interface	Integer
Access	Read only
Unit	-
Values	0 ... 9223372036854775807 (Increment: 1)

7.5.16 DeviceSFNCVersionMinor

Minor version of the Standard Features Naming Convention that was used to create the device's GenICam XML.

Name	DeviceSFNCVersionMinor
Category	DeviceControl
Interface	Integer
Access	Read only
Unit	-
Values	0 ... 9223372036854775807 (Increment: 1)

7.5.17 DeviceSFNCVersionSubMinor

Sub minor version of the Standard Features Naming Convention that was used to create the device's GenICam XML.

Name	DeviceSFNCVersionSubMinor
Category	DeviceControl
Interface	IInteger
Access	Read only
Unit	-
Values	0 ... 9223372036854775807 (Increment: 1)

7.5.18 DeviceScanType

Scan type of the sensor of the device.

Name	DeviceScanType
Category	DeviceControl
Interface	IEnumeration
Access	Read only
Unit	-
Values	Areascan 2D Sensor.

7.5.19 DeviceSensorType

This feature specifies the type of the sensor.

Name	DeviceSensorType
Category	DeviceControl
Interface	IEnumeration
Access	Read only
Unit	-
Values	CMOS CMOS sensor.

7.5.20 DeviceSerialNumber

Device's serial number. This string is a unique identifier of the device.

Name	DeviceSerialNumber
Category	DeviceControl
Interface	IString
Access	Read only
Unit	-
Values	e.g. 1117281217

7.5.21 DeviceStreamChannelCount

Indicates the number of streaming channels supported by the device.

Name	DeviceStreamChannelCount
Category	DeviceControl
Interface	IInteger
Access	Read only
Unit	-
Values	0 ... 4294967295 (Increment: 1)

7.5.22 DeviceStreamChannelEndianness

Endianness of multi-byte pixel data for this stream.

Name	DeviceStreamChannelEndianness
Category	DeviceControl
Interface	IEnumeration
Access	Read / Write
Unit	-
Values	Little Endianness of multi-byte pixel data for this stream is little Endian.

7.5.23 DeviceStreamChannelPacketSize

Specifies the stream packet size, in bytes, to send on the selected channel for a Transmitter or specifies the maximum packet size supported by a receiver.

Name	DeviceStreamChannelPacketSize
Category	DeviceControl
Interface	IInteger
Access	Read only
Unit	Byte
Values	576 ... 9000 (Increment: 2)

7.5.24 DeviceStreamChannelSelector

Selects the stream channel to control.

Name	DeviceStreamChannelSelector
Category	DeviceControl
Interface	IInteger
Access	Read / Write
Unit	-
Values	0 ... 0 (Increment: 1)

7.5.25 DeviceStreamChannelType

Reports the type of the stream channel.

Name	DeviceStreamChannelType
Category	DeviceControl
Interface	IEnumeration
Access	Read only
Unit	-
Values	Transmitter Data stream transmitter channel.

7.5.26 DeviceTLType

Transport Type of the device.

Name	DeviceTLType
Category	DeviceControl
Interface	IEnumeration
Access	Read only
Unit	-
Values	GigEVision

7.5.27 DeviceTLVersionMajor

Major version of the Transport Layer (GigE Vision® version) of the device.

Name	DeviceTLVersionMajor
Category	DeviceControl
Interface	Integer
Access	Read only
Unit	-
Values	0 ... 65535 (Increment: 1)

7.5.28 DeviceTLVersionMinor

Minor version of the Transport Layer (GigE Vision® version) of the device.

Name	DeviceTLVersionMinor
Category	DeviceControl
Interface	Integer
Access	Read only
Unit	-
Values	0 ... 65535 (Increment: 1)

7.5.29 DeviceTLVersionSubMinor

Minor version of the Transport Layer (GigE Vision® version) of the device.

Name	DeviceTLVersionSubMinor
Category	DeviceControl
Interface	IInteger
Access	Read only
Unit	-
Values	0 ... 9223372036854775807 (Increment: 1)

7.5.30 DeviceTemperature

Device temperature in degrees Celsius (C). It is measured at the location selected by *Device Temperature Selector*.

Name	DeviceTemperature
Category	DeviceControl
Interface	IFloat
Access	Read only
Unit	° C
Values	-127.0 ... 127.0

7.5.31 DeviceTemperatureSelector

Selects the location within the device, where the temperature will be measured.

Name	DeviceTemperatureSelector
Category	DeviceControl
Interface	IEnumeration
Access	Read / Write
Unit	-
Values	InHouse Temperature inside the camera housing.

7.5.32 DeviceType

Returns the device type.

Name	DeviceType
Category	DeviceControl
Interface	IEnumeration
Access	Read only
Unit	-
Values	Transmitter Data stream transmitter device.

7.5.33 DeviceUserID

User-programmable device identifier.

Name	DeviceUserID
Category	DeviceControl
Interface	IString
Access	Read / Write
Unit	-
Values	e.g. "camera 1" (max. length 64)

7.5.34 DeviceVendorName

Name of the manufacturer of the device.

Name	DeviceVendorName
Category	DeviceControl
Interface	IString
Access	Read only
Unit	-
Values	Name of the camera manufacturer

7.5.35 DeviceVersion

Version of the device.

Name	DeviceVersion
Category	DeviceControl
Interface	IString
Access	Read only
Unit	-
Values	e.g. R1.0.0

7.5.36 ReadOutTime

Readout time in μs for current format settings.

Notice	
Read Out Time depends on:	
<ul style="list-style-type: none">▪ OffsetX▪ OffsetY▪ Width▪ Height▪ PixelFormat	

Name	ReadOutTime
Category	DeviceControl
Interface	IInteger
Access	Read only
Unit	μs
Values	0 ... 65535 (Increment: 1)

7.5.37 TimestampLatch

Latches the current timestamp counter into *TimestampLatchValue*.

Name	TimestampLatch
Category	DeviceControl
Interface	ICommand
Access	Write only
Unit	-
Values	-

7.5.38 TimestampLatchValue

Returns the latched value of the timestamp counter.

Name	TimestampLatchValue
Category	DeviceControl
Interface	IInteger
Access	Read only
Unit	ns
Values	0 ... 9223372036854775807 (Increment: 8)

7.5.39 TimestampReset

Resets the current value of the device timestamp counter.

Name	TimestampReset
Category	DeviceControl
Interface	ICommand
Access	Write only
Unit	-
Values	-

7.6 Digital I/O Control

The Digital I/O chapter covers the features required to control the general Input and Output signals of the device.

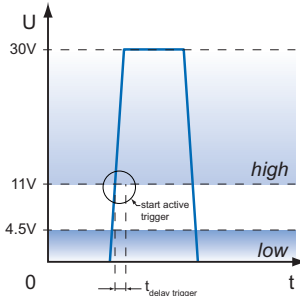

Trigger (Line Selector → Line 0 / Line 1) (General Information)

Trigger signals are used to synchronize the camera exposure and a machine cycle or, in case of a software trigger, to take images at predefined time intervals.

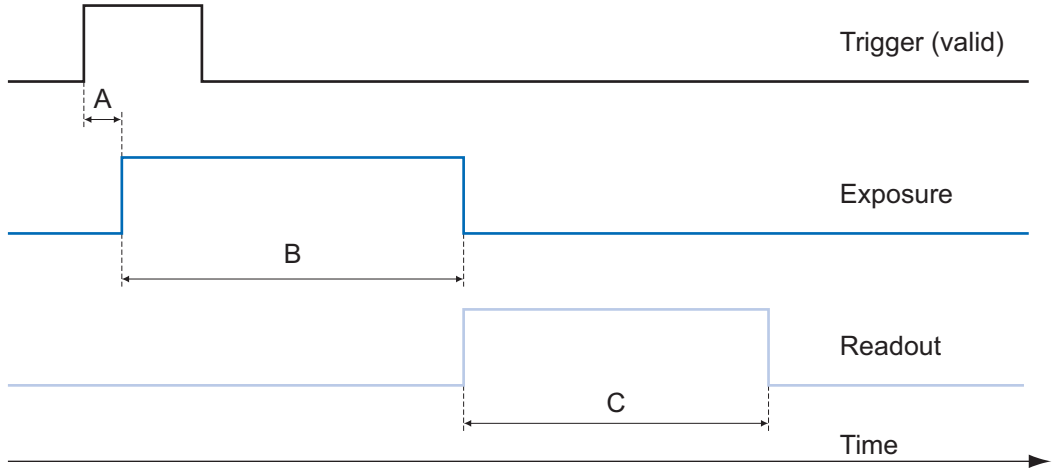

- A - Trigger delay
- B - Exposure time
- C - Readout time

Different trigger sources can be used here.

Trigger Delay:

The trigger delay is a flexible user-defined delay between the given trigger impulse and the image capture. The delay time can be set between 0.0 μ s and 2.0 s in increments of 1 μ s. Where there are multiple triggers during the delay, the triggers will also be stored and delayed. The buffer is able to store up to 512 trigger signals during the delay.

Your benefits:

- No need for an external trigger sensor to be perfectly aligned
- Different objects can be captured without hardware changes

Trigger Source (Examples of possible trigger sources)

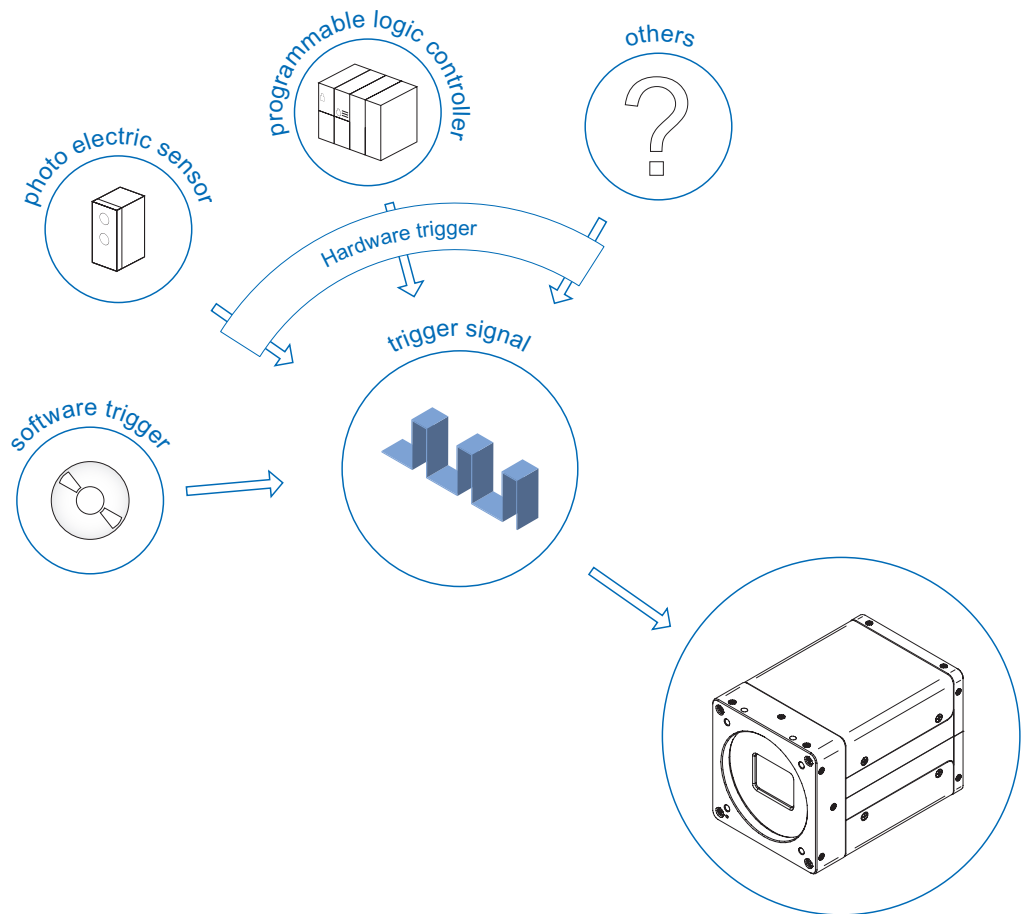

Each trigger source must be activated separately. When the trigger mode is activated, the hardware trigger is activated by default.

Debouncer (LineDebouncerHighTimeAbs / LineDebouncerLowTimeAbs)

The basic idea behind this features was to separate interfering signals (short peaks) from valid square wave signals, which can be important in industrial environments. Debouncing means that invalid signals are filtered out, and signals lasting longer than a user-defined testing time $t_{\text{DebounceHigh}}$ will be recognized and routed to the camera to induce a trigger.

In order to detect the end of a valid signal and filter out possible jitters within the signal, a second testing time $t_{\text{DebounceLow}}$ was introduced. The timing for this can also be adjusted by the user. If the signal value falls to state low and does not rise within $t_{\text{DebounceLow}}$, this is recognized as the end of the signal.

The debouncing times $t_{\text{DebounceHigh}}$ and $t_{\text{DebounceLow}}$ are adjustable from 0 to 5 ms in increments of 1 μs .

Notice

Please note that the edges of valid trigger signals are shifted by $t_{\text{DebounceHigh}}$ and $t_{\text{DebounceLow}}$.

Depending on these two timings, the trigger signal may be temporally stretched or compressed.

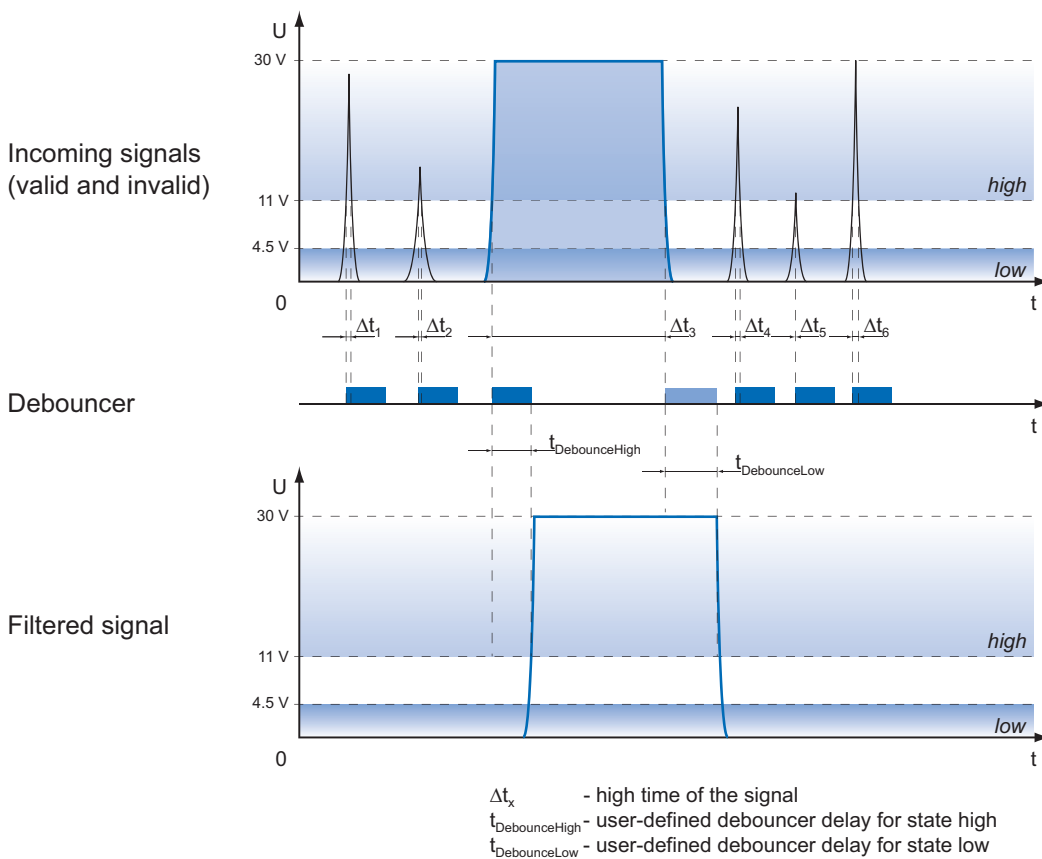

7.6.1 LineDebouncerHighTimeAbs

Sets the absolute value of the selected line debouncer time in microseconds for switch from low to high.

Name	LineDebouncerHighTimeAbs
Category	DigitalIOControl
Interface	IFloat
Access	Read / Write
Unit	µs
Values	0.000000 - 5,000.000000 (Increment: 1.00)

7.6.2 LineDebouncerLowTimeAbs

Sets the absolute value of the selected line debouncer time in microseconds for switch from high to low.

Name	LineDebouncerLowTimeAbs
Category	DigitalIOControl
Interface	IFloat
Access	Read / Write
Unit	µs
Values	0.000000 - 5,000.000000 (Increment: 1.00)

7.6.3 LineInverter

Controls the inversion of the signal of the selected input or output Line.

Name	LineInverter
Category	DigitalIOControl
Interface	IBoolean
Access	Read / Write
Unit	-
Values	true = 1 (On) false = 0 (Off)

7.6.4 LineMode

Controls if the physical Line is used to Input or Output a signal.

Name	LineMode
Category	DigitalIOControl
Interface	IEnumeration
Access	Read only
Unit	-
Values	Input The selected physical line is used to Input an electrical signal. Output The selected physical line is used to Output an electrical signal.

7.6.5 LineSelector

Selects the physical line (or pin) of the external device connector to configure.

Name	LineSelector	
Category	DigitalIOControl	
Interface	IEnumeration	
Access	Read / Write	
Unit	-	
Values	Line0	Index of the physical line and associated I/O control block to use.
	Line1	Index of the physical line and associated I/O control block to use.
	Line2	Index of the physical line and associated I/O control block to use.
	Line3	Index of the physical line and associated I/O control block to use.

7.6.6 LineSource

Output (Line Selector → Line 2 / Line 3)

Selects which internal acquisition or I/O source signal to output on the selected Line.

With this feature, Baumer gives you the option to wire the output connectors to internal signals that are controlled on the software side.

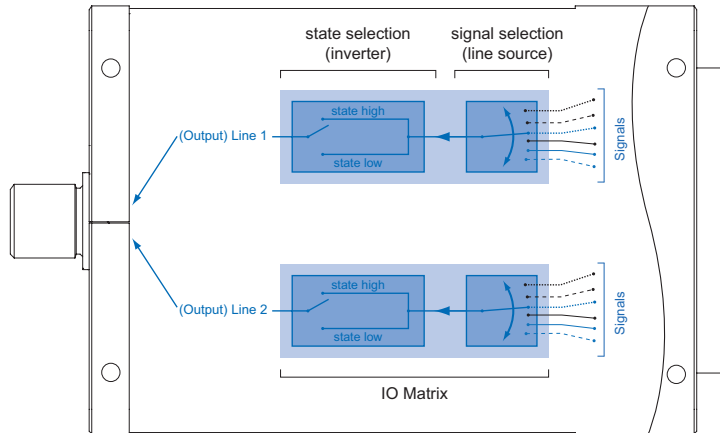

Input (Line Selector → Line 0 / Line 1)

The wiring of these input connector is left to the user.

Sole exception is the compliance with predetermined high and low levels (0 .. 4.5 V low, 11 .. 30 V high).

The defined signals will have no direct effect, but can be analyzed and processed on the software side and used for controlling the camera.

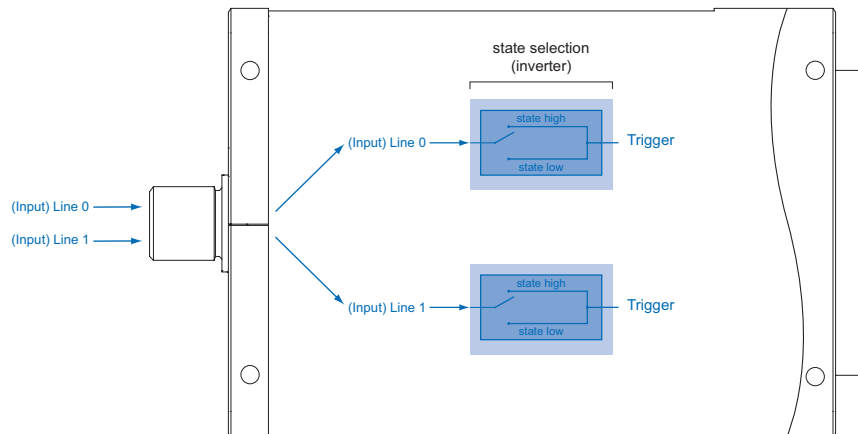

Name	LineSource	
Category	DigitalIOControl	
Interface	IEnumeration	
Access	Read / Write	
Unit	-	
Values	Off	Line output is disabled (Tri-State).
	ExposureActive	Device is doing the exposure of a Frame (or Line).
	Line 0	Device is currently waiting for signal of input line 0.
	Line 1	Device is currently waiting for signal of input line 1.
	ReadoutActive	Device is doing the readout of a Frame.

7.6.7 LineStatus

Returns the current status of the selected input or output Line.

Name	LineStatus
Category	DigitalIOControl
Interface	IBoolean
Access	Read only
Unit	-
Values	true = 1 (On) false = 0 (Off)

7.6.8 LineStatusAll

Returns the current status of all available Line signals at time of polling in a single bitfield.

Name	LineStatusAll
Category	DigitalIOControl
Interface	IInteger
Access	Read only
Unit	-
Values	Devices-Specific (HexNumber)

7.6.9 UserOutputSelector

Selects which bit of the User Output register will be set by UserOutputValue.

Name	UserOutputSelector
Category	DigitalIOControl
Interface	IEnumeration
Access	Read / Write
Unit	-
Values	UserOutput1 Selects the bit 0 of the User Output register. UserOutput2 Selects the bit 1 of the User Output register. UserOutput3 Selects the bit 2 of the User Output register.

7.6.10 UserOutputValue

Sets the value of the bit selected by UserOutputSelector.

Name	UserOutputValue
Category	DigitalIOControl
Interface	IBoolean
Access	Read / Write
Unit	-
Values	true = 1 (On) false = 0 (Off)

7.6.11 UserOutputValueAll

Sets the value of all the bits of the User Output register.

Name	UserOutputValueAll
Category	DigitalIOControl
Interface	IInteger
Access	Read only
Unit	-
Values	0 ... 4294967295 (Increment: 1)

7.7 EventControl

This chapter describes how to control the generation of Events to the host application. An Event is a message that is sent to the host application to notify it of the occurrence of an internal event.

General Information

The asynchronous message channel is described in the GigE Vision® standard and offers the possibility of event signaling. There is a timestamp (64 bits) for each announced event, which contains the accurate time the event occurred. Each event can be activated and deactivated separately.

Each event can be activated and deactivated separately (*EventSelector*).

Event	Event-ID	Description
EventLost	0x9021	Event was lost in the camera.
ExposureEnd	0x9001	Exposure ended.
ExposureStart	0x9000	Exposure started.
FrameEnd	0x9003	Device just completed the capture of one Frame.
FrameStart	0x9002	Device just started the capture of one Frame.
GigEVisionHeartbeatTimeOut	0x9023	Device runs in heartbeat timeout.
Line0FallingEdge	0x9008	Falling Edge is detected on the Line 0.
Line0RisingEdge	0x9007	Rising Edge is detected on the Line 0.
Line1FallingEdge	0x900A	Falling Edge is detected on the Line 1.
Line1RisingEdge	0x9009	Rising Edge is detected on the Line 1.
Line2FallingEdge	0x900C	Falling Edge is detected on the Line 2.
Line2RisingEdge	0x900B	Rising Edge is detected on the Line 2.
Line3FallingEdge	0x900D	Falling Edge is detected on the Line 3.
Line3RisingEdge	0x900D	Rising Edge is detected on the Line 3.
PrimaryApplication-Switch	0x0007	For systems where redundancy and fault recovery are required, it is often necessary for a second application to take control over the camera that is already under the control of a primary application. In order to notify the primary application that a switchover has occurred, send this event before granting access to new primary application.
TriggerOverlapped	0x9005	Trigger Overlapped.
TriggerReady	0x9004	Camera is able to process incoming trigger.
TriggerSkipped	0x9006	Camera reject an incoming trigger signal.

7.7.1 EventNotification

Activate or deactivate the notification to the host application of the occurrence of the selected Event.

Name	EventNotification	
Category	EventControl	
Interface	IEnumeration	
Access	Read / Write	
Unit	-	
Values	Off	The selected Event notification is disabled.
	On	The selected Event notification is enabled.

7.7.2 EventSelector

Selects which Event to signal to the host application.

Name	EventSelector	
Category	EventControl	
Interface	IEnumeration	
Access	Read / Write	
Unit	-	
Values	EventLost	
	ExposureEnd	
	ExposureStart	
	FrameEnd	
	FrameStart	
	GigEVisionHeartbeatTimeOut	
	Line0FallingEdge	
	Line0RisingEdge	
	Line1FallingEdge	
	Line1RisingEdge	
	Line2FallingEdge	
	Line2RisingEdge	
	Line3FallingEdge	
	Line3RisingEdge	
	PrimaryApplicationSwitch	
	TriggerOverlapped	
TriggerReady		
TriggerSkipped		

7.7.3 LostEventCounter

Counts lost events.

Name	LostEventCounter	
Category	EventControl	
Interface	IInteger	
Access	Read only	
Unit	-	
Values	0 ... 9223372036854775807 (Increment: 1)	

7.8 ImageFormatControl

This chapter describes how to influence and determine the image size and format.

Region of Interest (OffsetX / OffsetY / Width / Height) - General Information

You can use the "Region of Interest" (ROI) function to predefine a so-called region of interest or partial scan. This ROI is an area of pixels on the sensor. When an image is acquired, only the information regarding these pixels is transferred to the PC. Not all of the lines on the sensor are read out, which therefore decreases the readout time (t_{readout}). This increases the frame rate.

This function is used if only a particular region of the field of view is of interest. It also reduces the resolution.

The ROI is specified using four values:

- OffsetX - x-coordinate of the first relevant pixel
- OffsetY - y-coordinate of the first relevant pixel
- Width - horizontal size of the ROI
- Height - vertical size of the ROI

Step size:

- 24 Pixel horizontal (Width) and 12 lines vertical (Height)

Minimal ROI:

- The minimum ROI is: 32 × 4 pixel. (Width × Height)

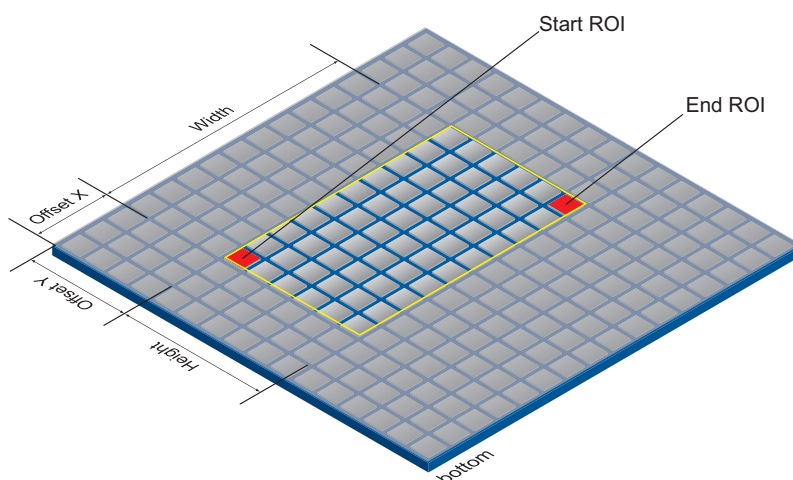

ROI Readout

In the illustration below, the readout time would decrease to 40% of a full frame readout.

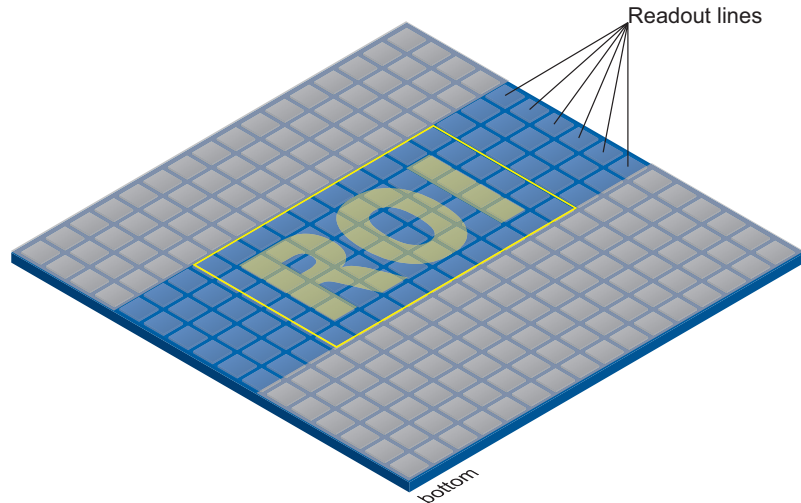

7.8.1 BinningHorizontal

Number of horizontal photo-sensitive cells to combine together. This increases the intensity (or signal to noise ratio) of the pixels and reduces the horizontal resolution (width) of the image.

Name	BinningHorizontal
Category	ImageFormatControl
Interface	IInteger
Access	Read / Write
Unit	-
Values	1 ... 1 (Increment: 1)

7.8.2 BinningHorizontalMode

Sets the mode to use to combine horizontal photo-sensitive cells together when BinningHorizontal is used.

Name	BinningHorizontalMode	
Category	ImageFormatControl	
Interface	IEnumeration	
Access	Read / Write	
Unit	-	
Values	Average	The response from the combined cells will be averaged, resulting in increased signal/noise ratio.

7.8.3 BinningSelector

Selects which binning engine is controlled by the BinningHorizontal and BinningVertical features.

Name	BinningSelector	
Category	ImageFormatControl	
Interface	IEnumeration	
Access	Read / Write	
Unit	-	
Values	Region0	Selected feature will control the region 0 binning.
	Sensor	Selected features will control the sensor binning.

7.8.4 BinningVertical

Number of vertical photo-sensitive cells to combine together. This increases the intensity (or signal to noise ratio) of the pixels and reduces the vertical resolution (height) of the image.

Name	BinningVertical	
Category	ImageFormatControl	
Interface	IInteger	
Access	Read / Write	
Unit	-	
Values	1 ... 1 (Increment: 1)	

7.8.5 BinningVerticalMode

The response from the combined cells will be averaged, resulting in increased signal/noise ratio.

Name	BinningHorizontalMode	
Category	ImageFormatControl	
Interface	IEnumeration	
Access	Read / Write	
Unit	-	
Values	Average	The response from the combined cells will be averaged, resulting in increased signal/noise ratio.

7.8.6 Height

Height of the image provided by the device (in pixels). The selected value changes with the change of *Binning*.

Notice

The sum of *Offset Y* and *Height* must be smaller or equal than *Height Max*.

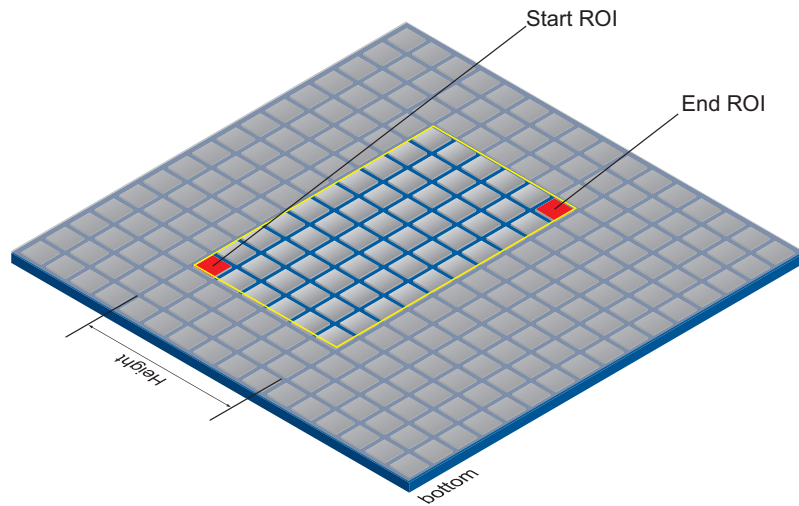

Name	Height
Category	ImageFormatControl
Interface	Integer
Access	Read / Write
Unit	-
Values	4 ... 3068 (Increment: 4)

7.8.7 HeightMax

Maximum height of the image (in pixels). This dimension is calculated after vertical binning, decimation or any other function changing the vertical dimension of the image.

Name	HeightMax
Category	ImageFormatControl
Interface	Integer
Access	Read only
Unit	-
Values	0 ... Resolution of the sensor in Y-direction.

7.8.8 OffsetX

Horizontal offset from the origin to the region of interest (in pixels).

Notice

The sum of *OffsetX* and *WidthMax* must be smaller or equal than *WidthMax*.

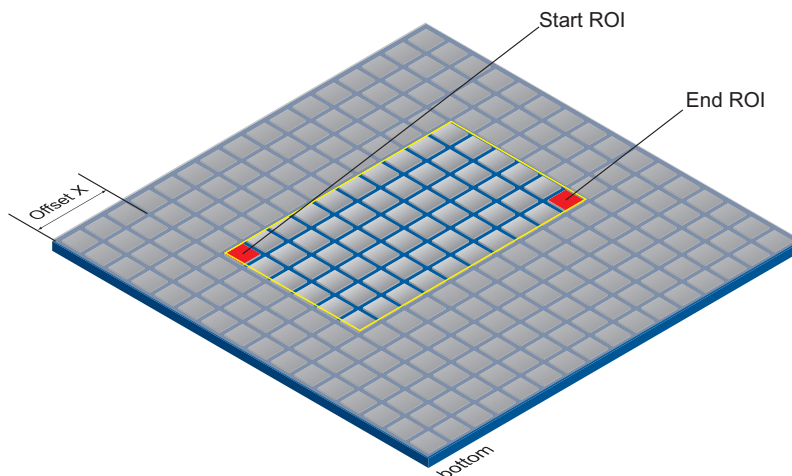

Name	OffsetX
Category	ImageFormatControl
Interface	Integer
Access	Read / Write
Unit	-
Values	0 - depends on setted <i>Width</i> (Increment: 32)

7.8.9 OffsetY

Vertical offset from the origin to the region of interest (in pixels).

Notice

The sum of *OffsetY* and *Height* must be smaller or equal than *HeightMax*.

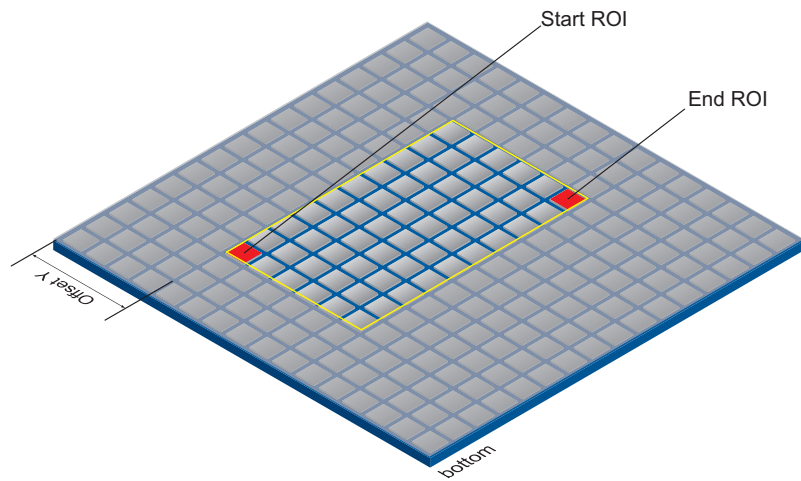

Name	OffsetY
Category	ImageFormatControl
Interface	IInteger
Access	Read / Write
Unit	-
Values	0 - depends on setted <i>Height</i> (Increment: 4)

7.8.10 PixelFormat

Format of the pixels provided by the device. It represents all the information provided by PixelCoding, PixelSize, PixelColorFilter combined in a single feature.

General Information

On Baumer digital cameras, the pixel format depends upon the image format selected.

Mono: Monochrome. The color range of mono images consists of shades of a single color. In general, shades of gray or black-and-white are synonyms for monochrome.

Pixel depth: In general, pixel depth defines the number of possible different values for each color channel. Mostly this will be 8 bit, which means 2^8 different "colors".

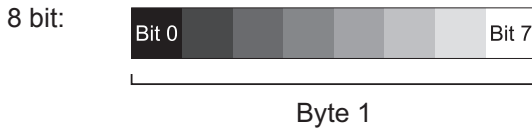

Notice

The camera must be stopped before PixelFormat can be set.

Name	PixelFormat	
Category	ImageFormatControl	
Interface	IEnumeration	
Access	Read / Write	
Unit	-	
Values	Mono8	Mono 8 bit. (only mono cameras)
	BayerGB8	Bayer Green Blue 8 bit. (only color cameras)

7.8.11 ReverseX (only monochrome cameras)

Flip horizontally the image sent by the device. The Region of interest is applied after the flipping.

Name	ReverseX
Category	ImageFormatControl
Interface	IBoolean
Access	Read / Write
Unit	-
Values	true = 1 (On)
	false = 0 (Off)

7.8.12 ReverseY (only monochrome cameras)

Flip vertically the image sent by the device. The Region of interest is applied after the flipping

Name	ReverseY
Category	ImageFormatControl
Interface	IBoolean
Access	Read / Write
Unit	-
Values	true = 1 (On) false = 0 (Off)

7.8.13 SensorHeight

Effective height of the sensor in pixels.

Name	SensorHeight
Category	ImageFormatControl
Interface	IInteger
Access	Read only
Unit	-
Values	0 ... 65535 (Increment: 1)

7.8.14 SensorWidth

Effective width of the sensor in pixels.

Name	SensorWidth
Category	ImageFormatControl
Interface	IInteger
Access	Read only
Unit	-
Values	0 ... 65535 (Increment: 1)

7.8.15 TestPattern

Selects the type of test pattern that is generated by the device as image source.

The following values are possible:

GreyDiagonalRamp	Image is filled diagonally with an image that goes from the darkest possible value to the brightest.
GreyDiagonalRampWith-LineMoving	Image is filled diagonally with an image that goes from the darkest possible value to the brightest with moving lines.
GreyHorizontalRamp	Image is filled horizontally with an image that goes from the darkest possible value to the brightest.
HorizontalAndVerticalLineMoving	Image is filled with moving horizontal and vertical lines.
HorizontalLineMoving	Image is filled with moving horizontal lines.
Off	Image is coming from the sensor.
VerticalLineMoving	Image is filled with moving vertical lines

Name	TestPattern
Category	ImageFormatControl
Interface	IEnumeration
Access	Read / Write
Unit	-
Values	(see table above)

7.8.16 TestPatternGeneratorSelector

Selects which test pattern generator is controlled by the *TestPattern* feature.

Name	TestPatternGeneratorSelector
Category	ImageFormatControl
Interface	IEnumeration
Access	Read / Write
Unit	-
Values	Sensor Processor TestPattern feature will control the sensor processor.

7.8.17 Width

Width of the image provided by the device (in pixels).

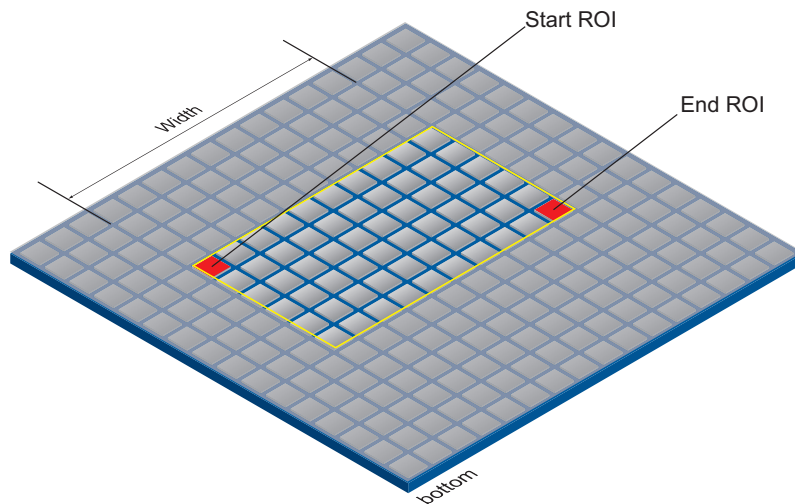

Name	Width
Category	ImageFormatControl
Interface	Integer
Access	Read / Write
Unit	-
Values	64 ... 4096 (Increment: 32)

7.8.18 WidthMax

Maximum width of the image (in pixels). The dimension is calculated after horizontal binning, decimation or any other function changing the horizontal dimension of the image.

Name	WidthMax
Category	ImageFormatControl
Interface	Integer
Access	Read only
Unit	-
Values	0 ... Resolution of the sensor in X-direction.

7.9 LUTControl

Features in this chapter describe the Look-up table (LUT) related features. For LUT related features, certain values are stored in the camera. This includes the coordinates of defective pixels so that they can be corrected.

General information (Pixel Correction)

There is a certain probability of abnormal pixels – so-called defect pixels – occurring within sensors from all manufacturers. The charge quantity of these pixels is not linearly dependent on the exposure time.

The occurrence of these defect pixels is unavoidable and intrinsic to the manufacturing and aging process of the sensors.

The operation of the camera is not affected by these pixels. They only appear as brighter (warm pixel) or darker (cold pixel) spots on the recorded image.

Distinction of "hot" and "cold" pixels within the recorded image.

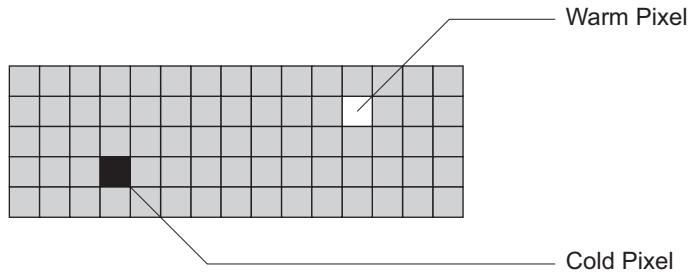

Charge quantity of "hot" and "cold" pixels compared with "normal" pixels:

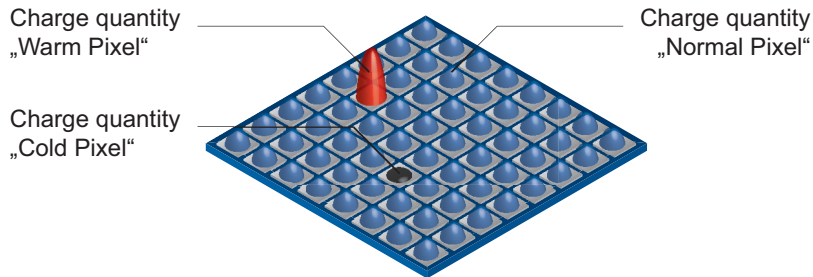

Correction Algorithm (Pixel Correction)

The problem of defect pixels is solved as follows:

- Possible defect pixels are identified during the camera's production process.
- The coordinates of these pixels are stored in the camera's factory settings.

Once the sensor readout is completed, correction takes place:

- Before any other processing begins, the values of the adjacent pixels on the left and the right side of the defect pixels are read out. (within the same Bayer phase for color)
- The average value of these 2 pixels is then determined in order to correct the first defect pixel
- Finally, the value of the second defect pixel is corrected using the previously corrected pixel and the pixel on the other side of the defect pixel.
- The correction process is able to correct up to two adjacent defect pixels.

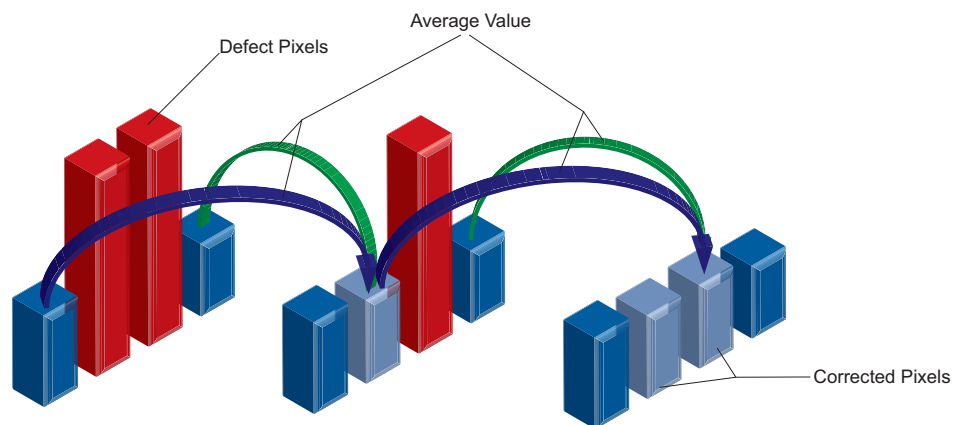

General Information (Defect Pixel List)

As stated previously, this list is determined during the camera's production and stored in the factory settings.

Additional hot or cold pixels can develop during the lifecycle of a camera. If this happens, Baumer gives you the option to add their coordinates to the defect pixel list.

You can determine the coordinates^{*)} of the affected pixels and add them to the list. Once the defect pixel list is stored in a user set, pixel correction is carried out for all coordinates on the defect pixel list.

Notice

There are defect pixels, which occur only under certain environmental parameters. These include temperatures or exposure settings.

Complete defect pixels that occur in your application.

*) Position in relation to full frame format (raw data format)

Add Defect Pixel to Defect Pixel List with Baumer Camera Explorer

Notice

The addition of defect pixels must be done in FullFrame (without *Binning*, without *Width / Height / OffsetX / OffsetY*), in raw data format and without activated color calculation.

1. Start the *Camera Explorer*. Connect to the camera. Select the profile *GenICam Guru*.
2. Open the category *LUT Control*.
3. Locate an empty *Defect Pixel List Index*.
Defect Pixel List Entry PosX = 0
Defect Pixel List Entry PosY = 0
Avoid using existing coordinates!
4. Determine the coordinates of the defect pixel. Keep the mouse pointer over the defect pixel. The coordinates of the defect pixel is displayed in the status bar.
For simplification, you can enlarge the image.
5. Enter the determined coordinates for X (*Defect Pixel List Entry PosX*) and Y (*Defect Pixel List Entry PosY*).
6. Activate the registered *Defect Pixel List Index* (*Defect Pixel List Entry Active = True*).
7. Stop the camera and start them again to take over the updated coordinates.
8. Save your settings in a User Set (Category: *User Set Control*). Coordinates, which are not stored in an user set will be lost after power reset.

7.9.1 DefectPixelCorrection

Enable the correction of defect pixels.

Name	DefectPixelCorrection
Category	LUTControl
Interface	IBoolean
Access	Read / Write
Unit	-
Values	true = 1 (On) false = 0 (Off)

7.9.2 DefectPixelListEntryActive

Determines if the pixel correction is active for the selected entry.

Name	DefectPixelListEntryActive
Category	LUTControl
Interface	IBoolean
Access	Read / Write
Unit	-
Values	true = 1 (On) false = 0 (Off)

7.9.3 DefectPixelListEntryPosX

X position of the defect pixel.

Name	DefectPixelListEntryPosX
Category	LUTControl
Interface	IInteger
Access	Read / Write
Unit	-
Values	0 ... 4095 (Increment: 1)

7.9.4 DefectPixelListEntryPosY

Y position of the defect pixel.

Name	DefectPixelListEntryPosY
Category	LUTControl
Interface	IInteger
Access	Read / Write
Unit	-
Values	0 ... 3071 (Increment: 1)

7.9.5 DefectPixelListIndex

Index to the pixel correction list.

Name	DefectPixelListIndex
Category	LUTControl
Interface	IInteger
Access	Read / Write
Unit	-
Values	0 ... 999 (Increment: 1)

7.9.6 DefectPixelListSelector

Selects which Defect Pixel List to control.

Name	DefectPixelListSelector	
Category	LUTControl	
Interface	IEnumeration	
Access	Read / Write	
Unit	-	
Values	Pixel	Selects Defect Pixel List for defect pixels.

7.9.7 FixedPatternNoisorrection

CMOS sensors exhibit nonuniformities that are often called fixed pattern noise (FPN). However it is no noise but a fixed variation from pixel to pixel that can be corrected. The advantage of using this correction is a more homogeneous picture which may simplify the image analysis. Variations from pixel to pixel of the dark signal are called dark signal non-uniformity (DSNU) whereas photo response nonuniformity (PRNU) describes variations of the sensitivity. DSNU is corrected via an offset while PRNU is corrected by a factor.

The correction is based on columns. It is important that the correction values are computed for the used sensor readout configuration. During camera production this is derived for the factory defaults. If other settings are used (e.g. different number of readout channels) using this correction with the default data set may degrade the image quality. In this case the user may derive a specific data set for the used setup.

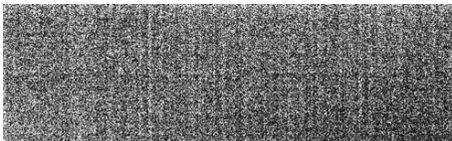

PRNU / DSNU Correction Off

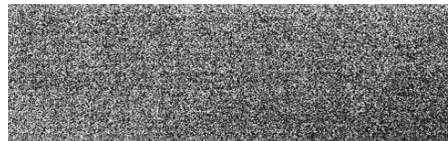

PRNU / DSNU Correction On

Name	FixedPatternNoisorrection	
Category	LUTControl	
Interface	IBoolean	
Access	Read / Write	
Unit	-	
Values	true = 1 (On)	false = 0 (Off)

7.10 Memory Management

The image acquisition of the QX camera can happen much faster than the interface can transfer the data to the PC. Therefore, acquisition and transfer are separated by a flexible buffer architecture within the camera.

This category describes the features to support the camera's buffer management in memory.

The camera is equipped with a dynamic memory management. This means that the size of the memory to be allocated dynamically adapts to the respective image settings.

Smaller pictures require less memory. Therefore, with smaller images, more Memory Part Blocks are available in each Memory Part.

There are 4 Memory Parts available. The following features are separately adjustable for each memory part:

- Memory Part Blocks
- Memory Part Mode
- Memory Part Increment Source

The following figure shows the process schematically.

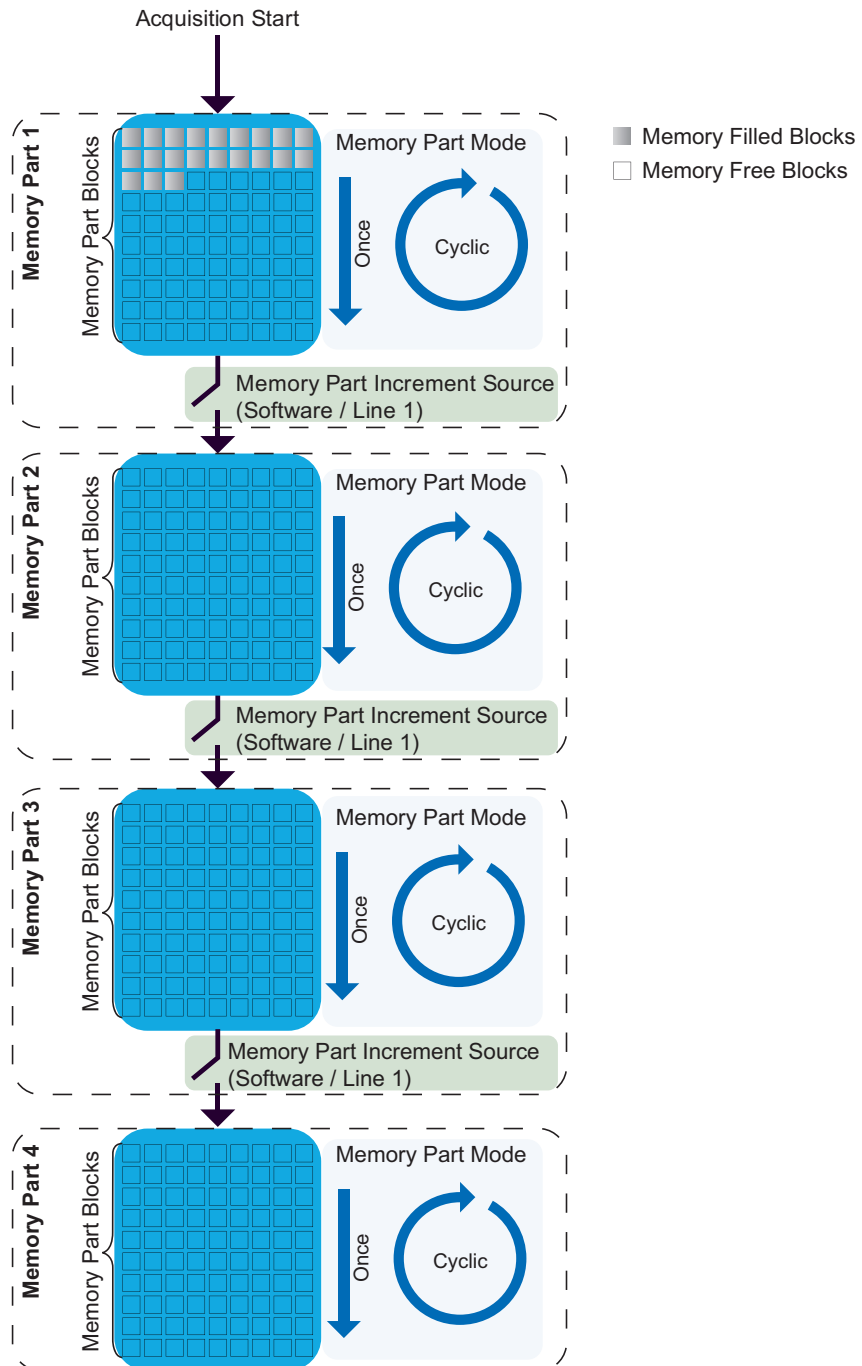

Memory Configuration with Baumer Camera Explorer

1. Start the *Camera Explorer*. Connect to the camera. Select the profile GenICam Guru.
2. Make the desired image settings (e.g. Category: Image Format Control → Width, Height, OffsetX, OffsetY, Category: Acquisition Control → Exposure Time).
3. Stop image acquisition.

Category: Acquisition Control → Acquisition Stop

Notice

Do not use the buttons on the toolbar of the Camera Explorer. These have other influences on the image acquisition too.

Use the start / stop features in the feature tree to control the camera!



Configure buffer management

4. Open the category *Memory Management*.

5. Set the Memory Mode to *Config*.

The figure shows the switching possibilities between the Memory Modes.

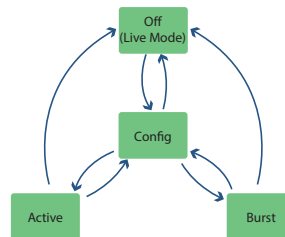

Notice

The mode Active is only available if settings have been made for at least one Memory Part.

For certain switches, e.g. from *Active* to *Config* or *Off (Live Mode)*, the buffer management of the camera is reinitialized. The previously buffered images are discarded in the camera.

6. There are four individually configurable memory parts available. Use the Memory Part Selector to select the desired Memory Part.
7. Set the Memory Part Blocks.

With this feature you set the number of images that will be stored in the selected Memory Part.

Notice

The available number of Memory Part Blocks depends on the image settings. The image settings apply to all four Memory Parts.

8. Set the Memory Part Mode.

With this feature, you set how the images are stored to the selected Memory Part.

Once: The selected memory part will be written once without overrun.

Cyclic: The selected memory part will be written cyclic.

9. Set the Memory Part Increment Source.

With this feature you define the source to switch the active memory part.

Line1: Selects line 1 as source to switch the active memory part.

Software: Selects the command Memory Part Increment Software as source to switch the active memory part.

10. Set the Memory Part Preview Ratio.

With this feature you can select preview images that will be transmitted to the host.

0 = no images are transmitted

1 = every image will be transmitted

5 = every fifth image will be transmitted

Notice

The preview of the images is done for all memory parts via Stream 0.

Set the Transfer Selector to Stream0.

Category: Transfer Control → Transfer Selector

Start image buffering in the configured Memory Parts

11. Set the Memory Mode to *Active*.

→ The settings for all adjusted Memory Parts are now activated.

12. Start image acquisition.

Category: Aquisition Control → Acquisition Start

Notice

Do not use the buttons on the toolbar of the Camera Explorer. These have other influences on the image acquisition too.

Use the start / stop features in the feature tree to control the camera!



→ The first Memory Part is filled with images as set (Memory Part Blocks, Memory Part Mode: Cycling / Once).

13. Switching to the next Memory Part is done as selected in Memory Part Increment Source.

Memory Part Increment Source: Software

Switch to the next Memory Part with Memory Part Increment Software feature.

Memory Part Increment Source: Line 1

Switch to the next memory part with a signal on Line 1.

14. After filling all configured memory parts (1 → 2 → 3 → 4), recording is stopped.

View the captured images

15. Stop image acquisition.

Category: Acquisition Control → Acquisition Stop

Notice	
Do not use the buttons on the toolbar of the Camera Explorer. These have other influences on the image acquisition too.	
Use the start / stop features in the feature tree to control the camera!	

16. Stop Stream 0.

Category: Transfer Control → Transfer Stop

17. Select the desired Stream / Memory Part from which the stored images should be displayed.

- Stream 1 → Images in Memory Part 1
- Stream 2 → Images in Memory Part 2
- Stream 3 → Images in Memory Part 3
- Stream 4 → Images in Memory Part 4

18. Start the display of the images with the feature Transfer Start.

Notice	
The images should be displayed again?	
Transfer Stop → Transfer Start	

7.10.1 MemoryActivePart

Returns the active memory part to write the images in.

Name	MemoryActivePart	
Category	MemoryManagement	
Interface	IEnumeration	
Access	Read only	
Unit	-	
Values	Part 1	Part 1 is the active memory part.
	Part 2	Part 2 is the active memory part.
	Part 3	Part 3 is the active memory part.
	Part 4	Part 4 is the active memory part.

7.10.2 MemoryFreeBlocks

Count of available memory blocks for configuration. It depends on partial scan features, pixelformat and selected acquisition format.

Name	MemoryFreeBlocks
Category	MemoryManagement
Interface	IInteger
Access	Read only
Unit	-
Values	-2147483648 ... 2147483647 (Increment: 1)

7.10.3 MemoryMaxBlocks

Maximum count of disposal memory blocks.

Name	MemoryMaxBlocks
Category	MemoryManagement
Interface	IInteger
Access	Read only
Unit	-
Values	0 ... 4294967295 (Increment: 1)

7.10.4 MemoryMode

Controls the mode to use the memory.

Notice

The camera must be stopped before the feature can be set.

Name	MemoryMode
Category	MemoryManagement
Interface	IEnumeration
Access	Read / Write
Unit	-
Values	see table below

The following values are possible:

Off (Live Mode) In this mode, the camera starts up. It is used to adjust the camera image regarding sharpness and aperture.
 The image read out by the sensor is always transmitted via the GigE interface and no image is buffered.

Notice

Images that cannot be transferred are discarded in the camera.

Config This mode is for configuring the internal memory of the camera.
 Choose this mode and make the desired settings for the respective features:

- the Memory Part
- the number of Memory Part Blocks
- the Memory Part Mode
- the Memory Part Preview Ratio

Active In this mode, images are captured with the settings made in Config mode.

Notice

The mode Active is only available if settings have been made for at least one Memory Part.

Burst In this mode, images are captured and written to memory. At the same time the images are transmitted via the GigE interface.

Notice

If no free buffer is available, the images are discarded in the camera.

The transfer of the data takes place via Stream0.

[see „7.12.3 TransferSelector“ on page 92](#)

The adjacent figure shows the switching possibilities between the Memory Modes.

Notice

For certain switches, e.g. from *Active* to *Config* or *Off (Live Mode)*, the buffer management of the camera is reinitialized. The previously buffered images are discarded in the camera.

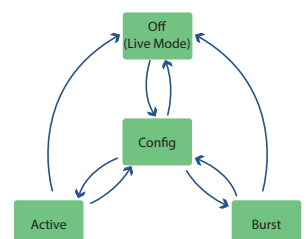

7.10.5 MemoryPartActiveBlock

Returns the index of the actual used memory block.

Name	MemoryPartActiveBlock
Category	MemoryManagement
Interface	Integer
Access	Read only
Unit	-
Values	-2147483648 ... 2147483647 (Increment: 1)

7.10.6 MemoryPartBlocks

Count of available memory blocks in the selected memory part.

Name	MemoryPartBlocks
Category	MemoryManagement
Interface	Integer
Access	Read / Write
Unit	-
Values	0 ... 89478485 (Increment: 1)

7.10.7 MemoryPartFilledBlocks

Returns the count of filled memory blocks in the selected memory part.

Name	MemoryPartFilledBlocks
Category	MemoryManagement
Interface	Integer
Access	Read only
Unit	-
Values	0 ... 4294967295 (Increment: 1)

7.10.8 MemoryPartFreeBlocks

Name	MemoryPartFreeBlocks
Category	MemoryManagement
Interface	Integer
Access	Read only
Unit	-
Values	0 ... 4294967295 (Increment: 1)

7.10.9 MemoryPartIncrementSoftware

Write to the command switch the active memory part incremental.

Name	MemoryPartIncrementSoftware
Category	MemoryManagement
Interface	ICommand
Access	Write only
Unit	-
Values	-

7.10.10 MemoryPartIncrementSource

Defines the source to switch the active memory part.

Name	MemoryPartIncrementSource	
Category	MemoryManagement	
Interface	IEnumeration	
Access	Read / Write	
Unit	-	
Values	Line 1	Selects line 1 as source to switch the active memory part.
	Software	Selects the command MemoryPartIncrementSoftware as source to switch the active memory part.

7.10.11 MemoryPartMode

Defines the mode to use for the selected memory part.

Name	MemoryPartMode	
Category	MemoryManagement	
Interface	IEnumeration	
Access	Read / Write	
Unit	-	
Values	Once	The selected memory part will be written once without overrun.
	Cyclic	The selected memory part will be written cyclic.

7.10.12 MemoryPartPreviewRatio

Selection of preview images transmitted to host.

Name	MemoryPartPreviewRatio
Category	MemoryManagement
Interface	IInteger
Access	Read / Write
Unit	-
Values	0 ... 65535 (Increment: 1)

7.10.13 MemoryPartSelector

Selects the disposal memory parts.

Name	MemoryPartSelector	
Category	MemoryManagement	
Interface	IEnumeration	
Access	Read / Write	
Unit	-	
Values	Part_1	Selects memory part 1.
	Part_2	Selects memory part 2.
	Part_3	Selects memory part 3.
	Part_4	Selects memory part 4.

7.11 SequencerControl

Category for the Sequencer Control features.

The Sequencer enables the possibility of image series recording including automated re-parameterization of the camera based on different events and signals. Therefore the desired camera settings for each step are stored in so called sequencer sets.

Stringing together a number of these sequencer sets results in a sequence. The connection of sequences is done by using different paths. Alongside the camera features the path related features are also part of a sequencer set.

Sequencer sets

Sequencer sets combine camera features – comparable with a user set – and sequencer (set and path) related parameters.

Settings for several camera features such as:

- Exposure time
- Gain
- Region of Interest (OffsetX / OffsetY / Width / Height)
- User output
- Counter

can be controlled by the sequencer and thus stored to a sequencer set as well as information for the set switch-over via four different paths.

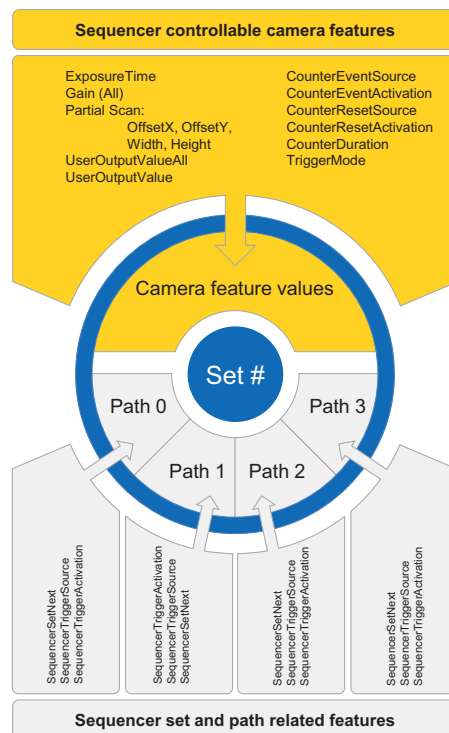

Each path involves:

- the destination for the set switch-over that is mapped by the SequencerSetNext feature
- the signal, whose change of state is used for triggering the set switch-over and that is mapped as SequencerTriggerSource
- the change of state triggering the set switch-over and that is mapped as 'Sequencer-TriggerActivation'

As with user sets the camera's current settings are overwritten once a sequencer set is loaded and the sequencer is activated.

Sequencer configuration

In order to avoid overwriting current camera settings while configuring a sequencer, the camera needs to be set to the sequencer configuration mode.

Once the camera is set to the sequencer configuration mode, the individual sequencer sets can be selected via the SequencerSetSelector, configured and saved by executing SequencerSetSave.

Starting the configured sequence requires to switch the sequencer configuration mode off and to enable the sequencer mode.

7.11.1 SequencerConfigurationMode

Controls if the sequencer configuration mode is active.

Name	SequencerConfigurationMode	
Category	SequencerControl	
Interface	IEnumeration	
Access	Read / Write	
Unit	-	
Values	On	Enables the sequencer configuration mode.
	Off	Disables the sequencer configuration mode.

7.11.2 SequencerFeatureEnable

Enables the selected feature and make it active in all the sequencer sets.

Name	SequencerFeatureEnable	
Category	SequencerControl	
Interface	IBoolean	
Access	Read only	
Unit	-	
Values	true = 1 (On)	
	false = 0 (Off)	

7.11.3 SequencerFeatureSelector

Selects the camera features that are controlled by the sequencer.

Name	SequencerFeatureSelector	
Category	SequencerControl	
Interface	IEnumeration	
Access	Read / Write	
Unit	-	
Values	CounterDuration	Sets the duration (or number of events) before the CounterEnd event is generated.
	CounterEventActivation	Selects the Activation mode Event Source signal.
	CounterEventSource	Select the events that will be the source to increment the Counter.
	CounterResetActivation	Selects the Activation mode of the Counter Reset Source signal.
	CounterResetSource	Selects the signals that will be the source to reset the Counter.
	ExposureMode	Sets the operation mode of the Exposure (or shutter).
	ExposureTime	Returns the exposure time used to capture the image.
	Gain	Controls the selected gain as an absolute physical value.
	Height	Height of the image provided by the device (in pixels).
	OffsetX	Horizontal offset from the origin to the region of interest (in pixels).
	OffsetY	Vertical offset from the origin to the region of interest (in pixels).
	TriggerMode	Controls if the selected trigger is active.
	UserOutputValue	Sets the value of the bit selected by UserOutputSelector.
	UserOutputValueAll	Sets the value of all the bits of the User Output register.
Width	Width of the image provided by the device (in pixels).	

7.11.4 SequencerMode

Controls if the sequencer mechanism is active.

Notice

To use this feature, the camera must be stopped and the features BalanceWhiteAuto (only color cameras) and SequencerConfigurationMode must be off.

Name	SequencerMode	
Category	SequencerControl	
Interface	IEnumeration	
Access	Read / Write	
Unit	-	
Values	On	Enables the sequencer.
	Off	Disables the sequencer.

7.11.5 SequencerPathSelector

Selects the path that contains the settings coming afterward.

Name	SequencerPathSelector
Category	SequencerControl
Interface	Integer
Access	Read / Write
Unit	-
Values	0 ... 3 (Increment: 1)

7.11.6 SequencerSetActive

Contains the currently active sequencer set.

Name	SequencerSetActive
Category	SequencerControl
Interface	Integer
Access	Read / Write
Unit	-
Values	0 ... 127 (Increment: 1)

7.11.7 SequencerSetLoad

Loads the sequencer set selected by SequencerSetSelector in the device.

Name	SequencerSetLoad
Category	SequencerControl
Interface	ICommand
Access	Write only
Unit	-
Values	-

7.11.8 SequencerSetNext

Specifies the next sequencer set.

Name	SequencerSetNext
Category	SequencerControl
Interface	Integer
Access	Read / Write
Unit	-
Values	0 ... 127 (Increment: 1)

7.11.9 SequencerSetSave

Saves the current device state to the sequencer set selected by the SequencerSetSelector.

Name	SequencerSetSave
Category	SequencerControl
Interface	ICommand
Access	Write only
Unit	-
Values	-

7.11.10 SequencerSetSelector

Selects the sequencer set to which further feature settings applies.

Name	SequencerSetSelector
Category	SequencerControl
Interface	Integer
Access	Read / Write
Unit	-
Values	0 ... 127 (Increment: 1)

7.11.11 SequencerSetStart

Sets the initial/start sequencer set, which is the first set used within a sequencer.

Name	SequencerSetStart
Category	SequencerControl
Interface	Integer
Access	Read / Write
Unit	-
Values	0 ... 127 (Increment: 1)

7.11.12 SequencerTriggerActivation

Defines the signals edge that triggers the sequencer.

Name	SequencerTriggerActivation	
Category	SequencerControl	
Interface	IEnumeration	
Access	Read / Write	
Unit	-	
Values	RisingEdge	Specifies that the trigger is considered valid on the rising edge of the source signal.
	FallingEdge	Specifies that the trigger is considered valid on the falling edge of the source signal.
	AnyEdge	Specifies that the trigger is considered valid on the falling or rising edge of the source signal.

7.11.13 SequencerTriggerSource

Specifies the internal signal or physical input line to use as the sequencer trigger source.

Name	SequencerTriggerSource	
Category	SequencerControl	
Interface	IEnumeration	
Access	Read / Write	
Unit	-	
Values	Off	Disables the sequencer trigger.
	Counter-1End	Starts with the reception of the Counter End.
	Counter-2End	Starts with the reception of the Counter End.
	Line0	Specifies Line 0 as external trigger source.
	Exposure-Active	Starts with the reception of the Exposure Active.</
	ReadOutActive	Starts with the reception of the Read Out Active.</
	Timer1End	Starts with the reception of the Timer End.

7.12 TransferControl

Category for the data Transfer Control features.

7.12.1 TransferControlMode

Selects the control method for the transfers.

Name	TransferControlMode
Category	TransferControl
Interface	IEnumeration
Access	Read / Write
Unit	-
Values	UserCon- trolled User Controlled.

7.12.2 TransferOperationMode

Selects the operation mode of the transfer.

Name	TransferOperationMode
Category	TransferControl
Interface	IEnumeration
Access	Read / Write
Unit	-
Values	Continuous Continous.

7.12.3 TransferSelector

Selects which stream transfers are currently controlled by the selected Transfer features.

Name	TransferSelector		
Category	TransferControl		
Interface	IEnumeration		
Access	Read / Write		
Unit	-		
Values			Memory Mode
	Stream0	The transfer features control the data stream 0.	- Off (Live Mode) - Burst image preview via the <i>MemoryPartPreviewRatio</i> feature
	Stream1	The transfer features control the data stream 1, used for memory part 1.	- Active
	Stream2	The transfer features control the data stream 2, used for memory part 2.	- Active
	Stream3	The transfer features control the data stream 3, used for memory part 3.	- Active
	Stream4	The transfer features control the data stream 4, used for memory part 4.	- Active

7.12.4 TransferStart

Starts the streaming of data blocks out of the device. This feature must be available when the TransferControlMode is set to "UserControlled". If the TransferStart feature is not writable (locked), the application should not start the transfer and should avoid using the feature until it becomes writable again.

Name	TransferStart
Category	TransferControl
Interface	ICommand
Access	Write only
Unit	-
Values	-

7.12.5 TransferStatus

Reads the status of the Transfer module signal selected by TransferStatusSelector.

Name	TransferStatus
Category	TransferControl
Interface	IBoolean
Access	Read only
Unit	-
Values	true = 1 (On)
	false = 0 (Off)

7.12.6 TransferStatusSelector

Selects which status of the transfer module to read.

Name	TransferStatusSelector	
Category	TransferControl	
Interface	IEnumeration	
Access	Read / Write	
Unit	-	
Values	Streaming	Data blocks are transmitted when enough data is available.

7.12.7 TransferStop

Stops the streaming of data Block(s). The current block transmission will be completed. This feature must be available when the TransferControlMode is set to "UserControlled".

Name	TransferStop	
Category	TransferControl	
Interface	ICommand	
Access	Write only	
Unit	-	
Values	-	

7.13 TransportLayerControl

This chapter provides the Transport Layer control features.

7.13.1 GigE Vision

Category that contains the features pertaining to the GigE Vision transport layer of the device.

7.13.1.1 GVSPConfigurationBlockID64Bit

Enables the 64 bit block ID length.

Name	GVSPConfigurationBlockID64Bit
Category	GigE Vision
Interface	IBoolean
Access	Read only
Unit	-
Values	true = 1 (On) false = 0 (Off)

7.13.1.2 GevCCP

Controls the device access privilege of an application.

Name	GevCCP
Category	GigE Vision
Interface	IEnumeration
Access	Read / Write
Unit	-
Values	OpenAccess Open Access. ExclusiveAccess Exclusive Access. ControlAccess Control Access.

7.13.1.3 GevCurrentDefaultGateway

Reports the default gateway IP address to be used on the given logical link.

Name	GevCurrentDefaultGateway
Category	GigE Vision
Interface	IInteger
Access	Read only
Unit	-
Values	IP address

7.13.1.4 GevCurrentIPAddress

Reports the IP address for the given logical link.

Name	GevCurrentIPAddress
Category	GigEVision
Interface	IInteger
Access	Read only
Unit	-
Values	IP address

7.13.1.5 GevCurrentIPConfigurationDHCP

Controls whether the DHCP IP configuration scheme is activated on the given logical link.

Name	GevCurrentIPConfigurationDHCP
Category	GigEVision
Interface	IBoolean
Access	Read / Write
Unit	-
Values	true = 1 (On) false = 0 (Off)

7.13.1.6 GevCurrentIPConfigurationLLA

Controls whether the Link Local Address IP configuration scheme is activated on the given logical link.

Name	GevCurrentIPConfigurationLLA
Category	GigEVision
Interface	IBoolean
Access	Read only
Unit	-
Values	true = 1 (On) false = 0 (Off)

7.13.1.7 **GevCurrentIPConfigurationPersistentIP**

Controls whether the PersistentIP configuration scheme is activated on the given logical link.

Name	GevCurrentIPConfigurationPersistentIP
Category	GigEVision
Interface	IBoolean
Access	Read / Write
Unit	-
Values	true = 1 (On) false = 0 (Off)

7.13.1.8 **GevCurrentSubnetMask**

Reports the subnet mask of the given logical link.

Name	GevCurrentSubnetMask
Category	GigEVision
Interface	IInteger
Access	Read only
Unit	-
Values	IP address

7.13.1.9 **GevFirstURL**

Indicates the first URL to the GenICam XML device description file. The First URL is used as the first choice by the application to retrieve the GenICam XML device description file.

Name	GevFirstURL
Category	GigEVision
Interface	IString
Access	Read only
Unit	-
Values	URL

7.13.1.10 **GevGVCPExtendedStatusCodes**

Enables the generation of extended status codes.

Name	GevGVCPExtendedStatusCodes
Category	GigEVision
Interface	IBoolean
Access	Read / Write
Unit	-
Values	true = 1 (On) false = 0 (Off)

7.13.1.11 GevGVCPExtendedStatusCodesSelector

Selects the GigE Vision version to control extended status codes for.

Name	GevGVCPExtendedStatusCodesSelector	
Category	GigE Vision	
Interface	IEnumeration	
Access	Read / Write	
Unit	-	
Values	Version1_1	Version1_1.
	Version2_0	Version2_0.

7.13.1.12 GevGVCPPendingAck

Enables the generation of PENDING_ACK.

Name	GevGVCPPendingAck	
Category	GigE Vision	
Interface	IBoolean	
Access	Read / Write	
Unit	-	
Values	true = 1 (On)	
	false = 0 (Off)	

7.13.1.13 GevIPConfigurationStatus

Reports the current IP configuration status.

Name	GevGVCPExtendedStatusCodesSelector	
Category	GigE Vision	
Interface	IEnumeration	
Access	Read only	
Unit	-	
Values	None	None.
	PersistentIP	Persistent IP.
	DHCP	DHCP.
	LLA	LLA.
	ForceIP	Force IP.

7.13.1.14 **GevInterfaceSelector**

Selects which logical link to control.

Name	GevInterfaceSelector
Category	GigEVision
Interface	Integer
Access	Read / Write
Unit	-
Values	≥ 0

7.13.1.15 **GevMACAddress**

MAC address of the logical link.

Name	GevMACAddress
Category	GigEVision
Interface	Integer
Access	Read only
Unit	-
Values	≥ 0

7.13.1.16 **GevMCDA**

Controls the destination IP address for the message channel.

Name	GevMCDA
Category	GigEVision
Interface	Integer
Access	Read / Write
Unit	-
Values	≥ 0

7.13.1.17 **GevMCPHostPort**

Controls the port to which the device must send messages.

Name	GevMCPHostPort
Category	GigEVision
Interface	Integer
Access	Read / Write
Unit	-
Values	≥ 0

7.13.1.18 GevMCRC

Controls the number of retransmissions allowed when a message channel message times out.

Name	GevMCRC
Category	GigEVision
Interface	Integer
Access	Read / Write
Unit	-
Values	≥ 0

7.13.1.19 GevMCSP

This feature indicates the source port for the message channel.

Name	GevMCSP
Category	GigEVision
Interface	Integer
Access	Read only
Unit	-
Values	≥ 0

7.13.1.20 GevMCTT

Provides the transmission timeout value in milliseconds.

Name	GevMCTT
Category	GigEVision
Interface	Integer
Access	Read only
Unit	ms
Values	≥ 0

7.13.1.21 GevNumberOfInterfaces

Indicates the number of logical links supported by this device.

Name	GevNumberOfInterfaces
Category	GigEVision
Interface	Integer
Access	Read only
Unit	-
Values	≥ 0

7.13.1.22 **GevPAUSEFrameReception**

Controls whether incoming PAUSE Frames are handled on the given logical link.

Name	GevPAUSEFrameReception
Category	GigEVision
Interface	IBoolean
Access	Read only
Unit	-
Values	true = 1 (On) false = 0 (Off)

7.13.1.23 **GevPersistentDefaultGateway**

Controls the persistent default gateway for this logical link. It is only used when the device boots with the Persistent IP configuration scheme.

Name	GevPersistentDefaultGateway
Category	GigEVision
Interface	Integer
Access	Read / Write
Unit	-
Values	≥ 0

7.13.1.24 **GevPersistentIPAddress**

Controls the Persistent IP address for this logical link. It is only used when the device boots with the Persistent IP configuration scheme.

Name	GevPersistentIPAddress
Category	GigEVision
Interface	Integer
Access	Read / Write
Unit	-
Values	≥ 0

7.13.1.25 **GevPersistentSubnetMask**

Controls the Persistent subnet mask associated with the Persistent IP address on this logical link. It is only used when the device boots with the Persistent IP configuration scheme.

Name	GevPersistentSubnetMask
Category	GigEVision
Interface	Integer
Access	Read / Write
Unit	-
Values	≥ 0

7.13.1.26 **GevPrimaryApplicationIPAddress**

Returns the address of the primary application.

Name	GevPrimaryApplicationIPAddress
Category	GigEVision
Interface	Integer
Access	Read only
Unit	-
Values	≥ 0

7.13.1.27 **GevPrimaryApplicationSocket**

Returns the UDP source port of the primary application.

Name	GevPrimaryApplicationSocket
Category	GigEVision
Interface	Integer
Access	Read only
Unit	-
Values	≥ 0

7.13.1.28 **GevPrimaryApplicationSwitchoverKey**

Controls the key to use to authenticate primary application switchover requests.

Name	GevPrimaryApplicationSwitchoverKey
Category	GigEVision
Interface	Integer
Access	Write only
Unit	-
Values	≥ 0

7.13.1.29 **GevSCDA**

Controls the destination IP address of the selected stream channel to which a GVSP transmitter must send data stream or the destination IP address from which a GVSP receiver may receive data stream.

Name	GevSCDA
Category	GigEVision
Interface	Integer
Access	Read / Write
Unit	-
Values	≥ 0

7.13.1.30 GevSCFTD

This feature indicates the delay (in timestamp counter unit) to insert between each block (image) for this stream channel.

Name	GevSCFTD
Category	GigEVision
Interface	Integer
Access	Read / Write
Unit	-
Values	0 ... 4294967295 (Increment: 1)

7.13.1.31 GevSCPD

Controls the delay (in timestamp counter unit) to insert between each packet for this stream channel. This can be used as a crude flow-control mechanism if the application or the network infrastructure cannot keep up with the packets coming from the device.

Name	GevSCPD
Category	GigEVision
Interface	Integer
Access	Read / Write
Unit	-
Values	0 ... 4294967295 (Increment: 1)

7.13.1.32 GevSCPHostPort

Controls the port of the selected channel to which a GVSP transmitter must send data stream or the port from which a GVSP receiver may receive data stream. Setting this value to 0 closes the stream channel.

Name	GevSCPHostPort
Category	GigEVision
Interface	Integer
Access	Read / Write
Unit	-
Values	0 ... 65535 (Increment: 1)

7.13.1.33 GevSCPIInterfaceIndex

Index of the logical link to use.

Name	GevSCPIInterfaceIndex
Category	GigEVision
Interface	Integer
Access	Read / Write
Unit	-
Values	0 ... 3 (Increment: 1)

7.13.1.34 GevSCPSDoNotFragment

The state of this feature is copied into the "do not fragment" bit of IP header of each stream packet. It can be used by the application to prevent IP fragmentation of packets on the stream channel.

Name	GevSCPSDoNotFragment
Category	GigEVision
Interface	IBoolean
Access	Read / Write
Unit	-
Values	true = 1 (On) false = 0 (Off)

7.13.1.35 GevSCPSFireTestPacket

Sends a test packet. When this feature is set, the device will fire one test packet.

Name	GevSCPSFireTestPacket
Category	GigEVision
Interface	IBoolean
Access	Read / Write
Unit	-
Values	true = 1 (On) false = 0 (Off)

7.13.1.36 GevSCPSPacketSize

Specifies the stream packet size, in bytes, to send on the selected channel for a GVSP transmitter or specifies the maximum packet size supported by a GVSP receiver.

Name	GevSCPSPacketSize
Category	GigEVision
Interface	IInteger
Access	Read / Write
Unit	Byte
Values	576 ... 16110 (Increment: 2)

7.13.1.37 GevSCSP

Indicates the source port of the stream channel.

Name	GevSCSP
Category	GigEVision
Interface	Integer
Access	Read only
Unit	-
Values	≥ 0

7.13.1.38 GevSondURL

Indicates the sond URL to the GenICam XML device description file. This URL is an alternative if the application was unsuccessful to retrieve the device description file using the first URL.

Name	GevSondURL
Category	DeviceControl
Interface	IString
Access	Read only
Unit	-
Values	URL

7.13.1.39 GevStreamChannelSelector

Selects the stream channel to control.

Name	GevStreamChannelSelector
Category	GigEVision
Interface	Integer
Access	Read / Write
Unit	-
Values	≥ 0

7.13.1.40 GevSupportedOption

Returns if the selected GEV option is supported.

Name	GevSupportedOption
Category	GigEVision
Interface	IBoolean
Access	Read / Write
Unit	-
Values	true = 1 (On) false = 0 (Off)

7.13.1.41 GevSupportedOptionSelector

Selects the GEV option to interrogate for existing support.

Name	GevSupportedOptionSelector	
Category	GigEVision	
Interface	IEnumeration	
Access	Read / Write	
Unit	-	
Values	Action	Action.
	CCPApplicationSocket	CCP Application Socket.
	CommandsConcatenation	Commands Concatenation.
	DiscoveryAckDelay	Discovery Ack Delay.
	DiscoveryAckDelayWritable	Discovery Ack Delay Writable.
	DynamicLAG	Dynamic LAG.
	Event	Event.
	EventData	Event Data.
	ExtendedStatusCodes	Extended Status Codes.
	ExtendedStatusCodesVersion2_0	ExtendedStatusCodesVersion2_0.
	HeartbeatDisable	Heartbeat Disable.
	IEEE1588	IEEE 1588.
	IPConfigurationDHCP	IP Configuration DHCP.
	IPConfigurationLLA	IP Configuration LLA.
	IPConfigurationPersistentIP	IP Configuration Persistent IP.
	LinkSpeed	Link Speed.
	ManifestTable	Manifest Table.
	MessageChannelSourceSocket	Message Channel Source Socket.
	MultiLink	Multi Link.
	PAUSEFrameGeneration	PAUSE Frame Generation.
	PAUSEFrameReception	PAUSE Frame Reception.
	PacketResend	Packet Resend.
	PendingAck	Pending Ack.
	PrimaryApplicationSwitchover	Primary Application Switchover.
	ScheduledAction	Scheduled Action.
	SerialNumber	Serial Number.
	SingleLink	Single Link.
	StandardIDMode	Standard ID Mode.
	StaticLAG	Static LAG.
	TestData	Test Data.
	UnconditionalAction	Unconditional Action.
	UserDefinedName	User Defined Name.
	WriteMem	Write Mem.

7.13.2 PayloadSize

Provides the number of bytes transferred for each image or chunk on the stream channel at the current settings. This includes any end-of-line, end-of-frame statistics or other stamp data. This is the total size of data payload for a data block.

Name	PayloadSize
Category	TransportLayerControl
Interface	Integer
Access	Read only
Unit	Byte
Values	0 ... depends on current settings (Increment: 1)

7.14 UserSetControl

Category that contains the User Set control features. It allows loading or saving factory or user-defined settings.

Loading the factory default User Set guarantees a state where a continuous acquisition can be started using only the mandatory features.

These user sets are stored within the camera and can be loaded, saved and transferred to other cameras.

By using *User Set Default* one of these four user sets can be set as the default, which means that the camera starts up with these adjusted parameters.

7.14.1 UserSetDefault

Four user sets are available for this camera. *User Set 1*, *User Set 2*, *User Set 3* are user-specific and can contain auser-definable parameters.

Selects the feature *UserSet* to load and make active by default when the device is reset. The factory settings are stored in the user set *Default*. This is the only user set that cannot be edited.

Notice

All saved user sets can be set as default.

Name	UserSetDefault	
Category	UserSetControl	
Interface	IEnumeration	
Access	Read / Write	
Unit	-	
Values	Default	Select the factory setting user set.
	User Set 1	Select the User Set 1 (available when saved).
	User Set 2	Select the User Set 2 (available when saved).
	User Set 3	Select the User Set 3 (available when saved).

7.14.2 UserSetFeatureEnable

Enables the selected feature and make it active in all the UserSets.

Name	UserSetFeatureEnable
Category	UserSetControl
Interface	IBoolean
Access	Read only
Unit	-
Values	true = 1 (On) false = 0 (Off)

7.14.3 UserSetFeatureSelector

Selects which individual UserSet feature to control.

Name	UserSetFeatureSelector
Category	UserSetControl
Interface	IEnumeration
Access	Read / Write
Unit	-

	Features whose values are stored in the user set:	
	AcquisitionFrameRate	LineDebouncerLowTimeAbs
	AcquisitionFrameRateEnable	LineInverter
	AcquisitionMode	LineSource
	BinningHorizontal	OffsetX
	BinningHorizontalMode	OffsetY
	BinningVertical	PixelFormat
	BinningVerticalMode	ReadoutMode
	BlackLevel	ReverseX
	ChunkEnable	ReverseY
	ChunkModeActive	SequencerMode
	CounterDuration	SequencerSetNext
	CounterEventActivation	SequencerSetStart
Values	CounterEventSource	SequencerTriggerActivation
	CounterResetActivation	SequencerTriggerSource
	CounterResetSource	TestPattern
	DefectPixelCorrection	TimerDelay
	EventNotification	TimerDuration
	ExposureMode	TimerTriggerActivation
	ExposureTime	TimerTriggerSource
	FixedPatternNoisocorrection	TriggerActivation
	FrameCounter	TriggerDelay
	Gain	TriggerMode
	GevSCFTD	TriggerSource
	GevSCPD	UserOutputValue
	Height	UserOutputValueAll
	LineDebouncerHighTimeAbs	Width

7.14.4 UserSetLoad

Loads the *UserSet* specified by *UserSetSelector* to the device and makes it active.

Notice

Loading a *UserSet* requires the stop of the camera.

Name	UserSetLoad
Category	UserSetControl
Interface	ICommand
Access	Write only
Unit	-
Values	-

7.14.5 UserSetSave

Save the User Set specified by *UserSetSelector* to the non-volatile memory of the device

Notice

The factory settings are stored in the user set *Default*. This is the only user set that cannot be edited. Select at *UserSetSelector* *UserSet1*, *UserSet2* or *UserSet3*.

Name	UserSetSave
Category	UserSetControl
Interface	ICommand
Access	Write only
Unit	-
Values	-

7.14.6 UserSetSelector

Selects the Feature User Set to load, save or configure. The factory settings are stored in the user set *Default*. This is the only user set that cannot be edited.

Name	UserSetSelector	
Category	UserSetControl	
Interface	IEnumeration	
Access	Read / Write	
Unit	-	
Values	Default	Select the factory setting user set.
	User Set 1	Select the User Set 1.
	User Set 2	Select the User Set 2.
	User Set 3	Select the User Set 3.

8. Interface Functionalities

8.1 Device Information

By using GigE all data packets are sequentially transmitted over one cable. At the beginning of a frame will transmitted a Leader and at the end will transmitted a Trailer.

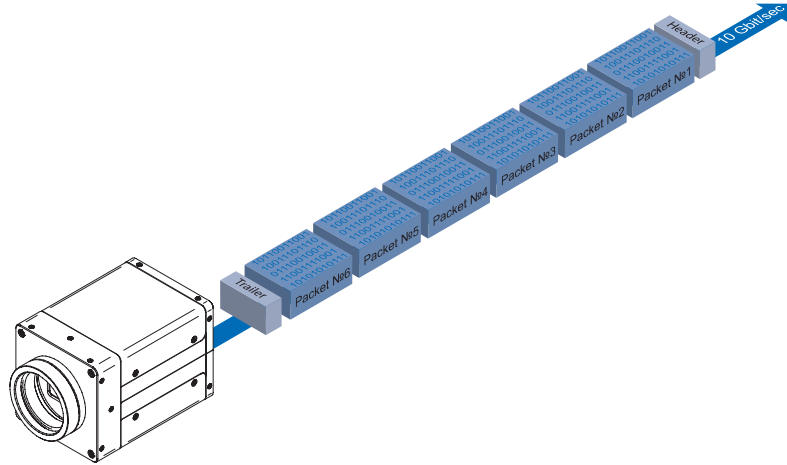

8.2 Packet Size and Maximum Transmission Unit (MTU)

Network packets can be of different sizes. The size depends on the network components employed. When using GigE Vision[®]- compliant devices, it is generally recommended to use larger packets. On the one hand the overhead per packet is smaller, on the other hand larger packets cause less CPU load.

The packet size of UDP packets can differ from 576 Bytes up to the MTU.

The MTU describes the maximal packet size which can be handled by all network components involved.

In principle modern network hardware supports a packet size of 1518 Byte, which is specified in the network standard. However, so-called "Jumbo frames" are on the advance as Gigabit Ethernet continues to spread. "Jumbo frames" merely characterizes a packet size exceeding 1500 Bytes.

Baumer VQXT cameras can handle a MTU of up to 16384 Bytes.

8.3 Inter Packet Gap (IPG)

To achieve optimal results in image transfer, several Ethernet-specific factors need to be considered when using Baumer cameras.

Upon starting the image transfer of a camera, the data packets are transferred at maximum transfer speed (1 Gbit/s / 10 Gbit/s). In accordance with the network standard, Baumer employs a minimal separation of 12 Bytes between two packets. This separation is called "Inter Packet Gap" (IPG). In addition to the minimal PD, the GigE Vision® standard stipulates that the PD be scalable (user-defined).

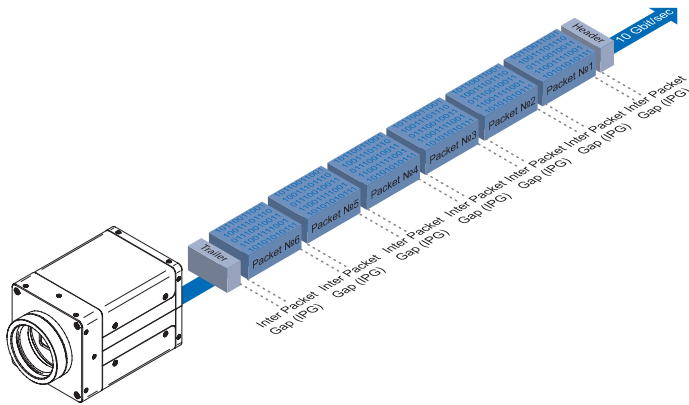

8.3.1 Example 1: Multi Camera Operation – Minimal IPG

Setting the IPG to minimum means every image is transferred at maximum speed. Even by using a frame rate of 1 fps this results in full load on the network. Such "bursts" can lead to an overload of several network components and a loss of packets. This can occur, especially when using several cameras.

In the case of two cameras sending images at the same time, this would theoretically occur at a transfer rate of 2 Gbits/s. The switch has to buffer this data and transfer it at a speed of 1 Gbit/s afterwards. Depending on the internal buffer of the switch, this operates without any problems up to n cameras ($n \geq 1$). More cameras would lead to a loss of packets. These lost packets can however be saved by employing an appropriate resend mechanism, but this leads to additional load on the network components.

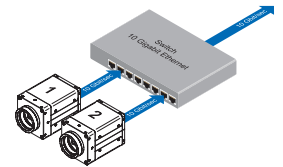

Operation of two cameras employing a Ethernet switch. Data processing within the switch is displayed in the next two figures.

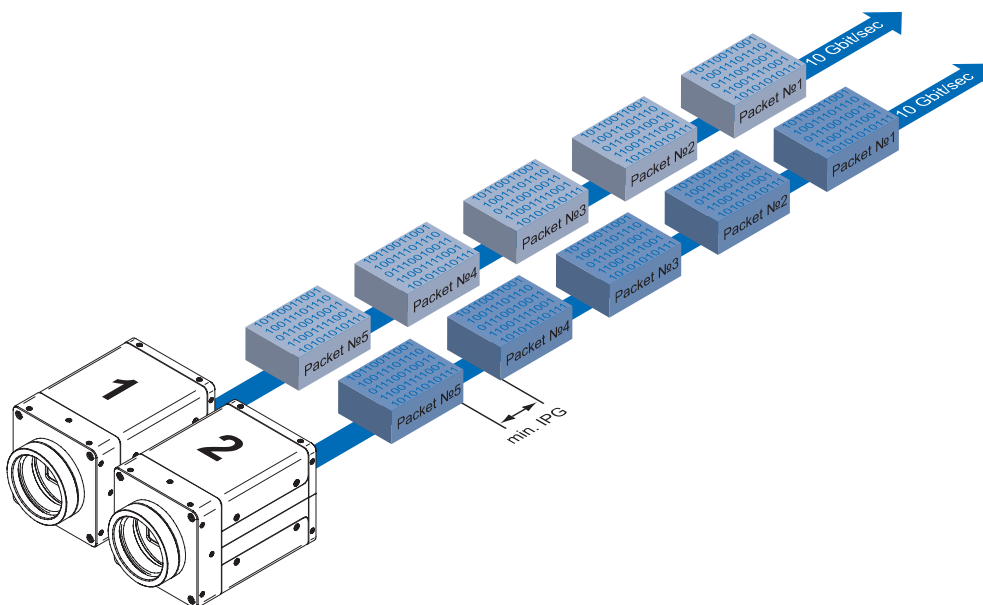

8.3.2 Example 2: Multi Camera Operation – Optimal IPG

A better method is to increase the IPG to a size of

$$\text{optimal IPG} = \text{packet size} + 2 \times \text{minimal IPG}$$

In this way both data packets can be transferred successively (zipper principle), and the switch does not need to buffer the packets.

Max. IPG:

On the Gigabit Ethernet the max. IPG and the data packet must not exceed 1 Gbit. Otherwise data packets can be lost.

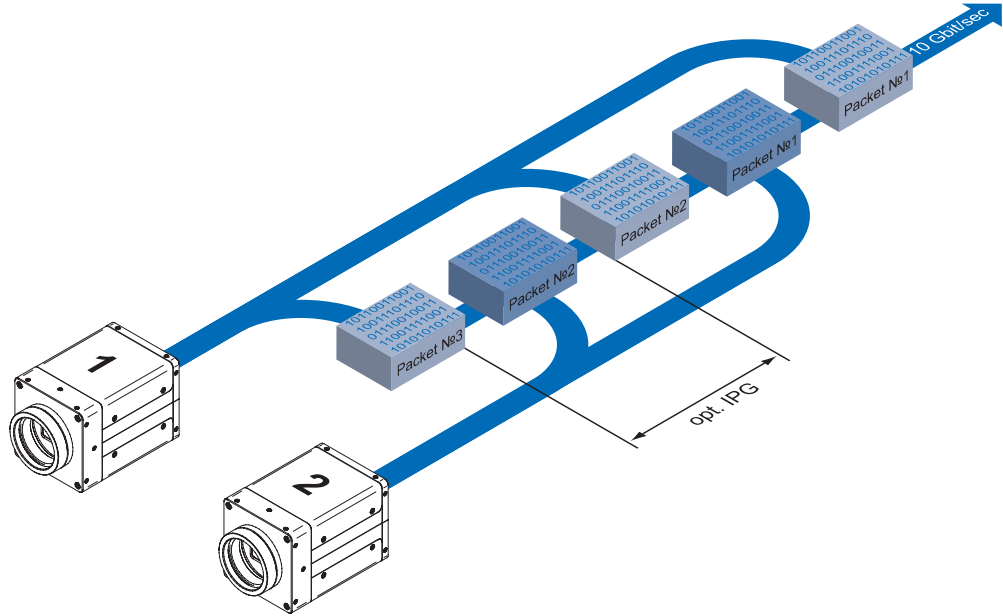

8.4 Frame Delay

Another approach for packet sorting in multi-camera operation is the so-called Frame Delay. Due to the fact, that the currently recorded image is stored within the camera and its transmission starts with a predefined delay, complete images can be transmitted to the PC at once.

The following figure should serve as an example:

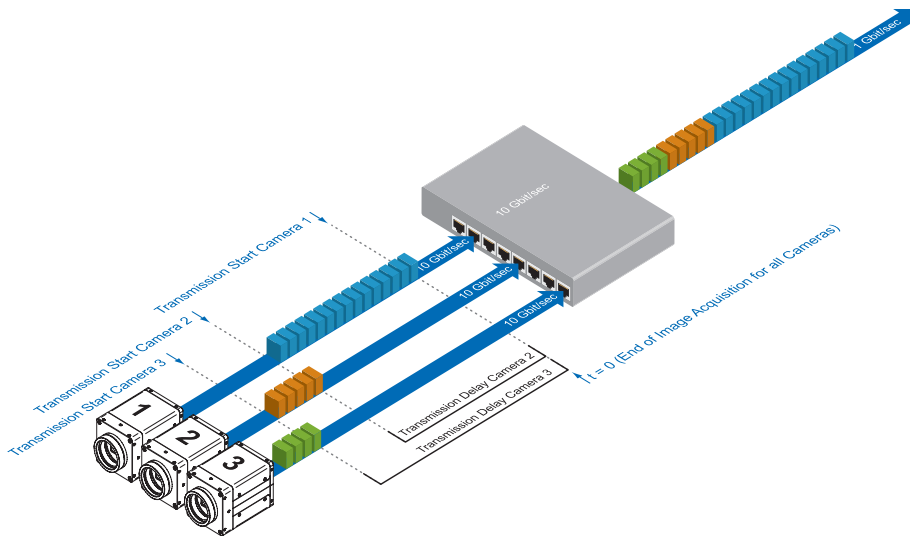

Due to process-related circumstances, the image acquisitions of all cameras end at the same time. Now the cameras are not trying to transmit their images simultaneously, but – according to the specified transmission delays – subsequently. Thereby the first camera starts the transmission immediately – with a transmission delay "0".

8.4.1 Time Saving in Multi-Camera Operation

As previously stated, the Frame delay feature was especially designed for multi-camera operation with employment of different camera models. Just here an significant acceleration of the image transmission can be achieved:

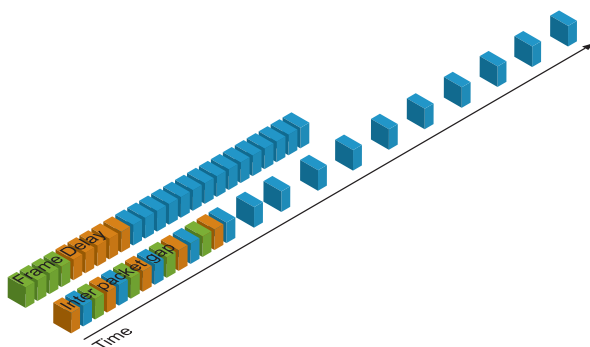

For the above mentioned example, the employment of the transmission delay feature results in a time saving – compared to the approach of using the inter packet gap – of approx. 45% (applied to the transmission of all three images).

8.4.2 Configuration Example

For the three used cameras the following data are known:

Camera Model	Sensor Resolution [Pixel]	Pixel Format (Pixel Depth) [bit]	Data Volume [bit]	Readout Time [ms]	Exposure Time [ms]	Transfer Time [ms]
VQXT-120	4096 × 3068	8	100532224	2.97	16	≈ 46.81
VQXT-120	4096 × 3068	8	100532224	2.97	16	≈ 46.81
VQXT-120	4096 × 3068	8	100532224	2.97	16	≈ 46.81

- The sensor resolution and the readout time (t_{readout}) can be found in the respective Technical Data Sheet (TDS). For the example a full frame resolution is used.
- The exposure time (t_{exposure}) is manually set to 6 ms.

- The resulting data volume is calculated as follows:

$$\text{Resulting Data Volume} = \text{horizontal Pixels} \times \text{vertical Pixels} \times \text{Pixel Depth}$$

- The transfer time ($t_{\text{transferGigE}}$) is calculated as follows:

$$\text{Transfer Time} = \text{Resulting Data Volume} / 1024^3 \times 500 \text{ [ms]}$$

All the cameras are triggered simultaneously.

The transmission delay is realized as a counter, that is started immediately after the sensor readout is started.

Timings:

- A - exposure start for all cameras
- B - all cameras ready for transmission
- C - transmission start camera 2
- D - transmission start camera 3

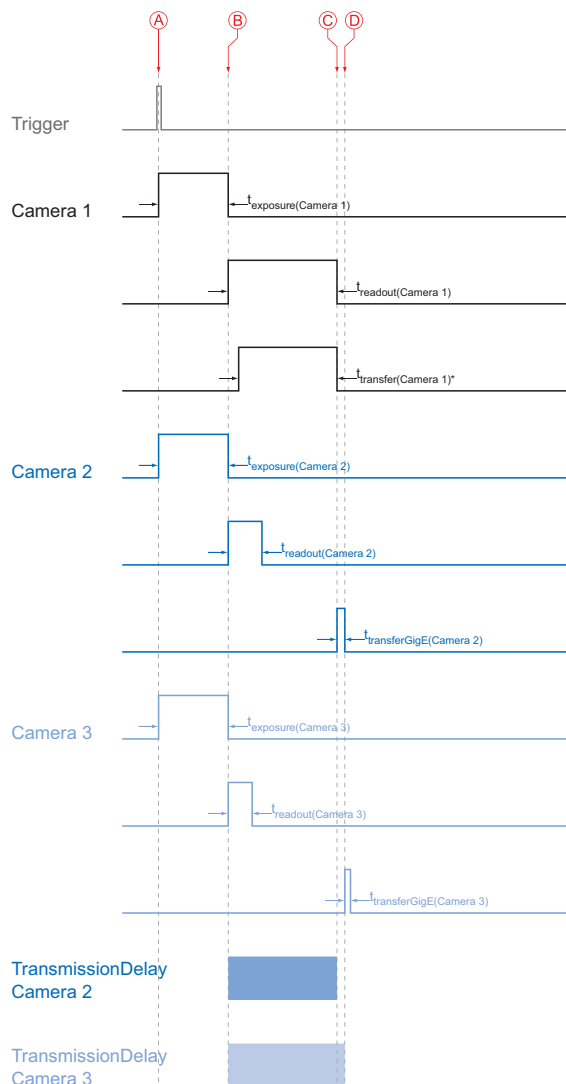

* Due to technical issues the data transfer of camera 1 does not take place with full speed.

In general, the transmission delay is calculated as:

$$t_{TransmissionDelay(Camera\ n)} = t_{exposure(Camera\ 1)} + t_{readout(Camera\ 1)} - t_{exposure(Camera\ n)} + \sum_{n \geq 3}^n t_{transferGigE(Camera\ n-1)}$$

Therewith for the example, the transmission delays of camera 2 and 3 are calculated as follows:

$$t_{TransmissionDelay(Camera\ 2)} = t_{exposure(Camera\ 1)} + t_{readout(Camera\ 1)} - t_{exposure(Camera\ 2)}$$

$$t_{TransmissionDelay(Camera\ 3)} = t_{exposure(Camera\ 1)} + t_{readout(Camera\ 1)} - t_{exposure(Camera\ 3)} + t_{transferGige(Camera\ 2)}$$

Solving this equations leads to:

$$\begin{aligned} t_{TransmissionDelay(Camera\ 2)} &= 16\ ms + 2.97\ ms - 16\ ms \\ &= 2.97\ ms \\ &= 2970000\ ticks \end{aligned}$$

$$\begin{aligned} t_{TransmissionDelay(Camera\ 3)} &= 16\ ms + 2.97\ ms - 16\ ms + 46.81\ ms \\ &= 49.78\ ms \\ &= 49780000\ ticks \end{aligned}$$

Notice

In Baumer GAPI the delay is specified in ticks. How do convert microseconds into ticks?

$$1\ tick = 1\ ns$$

$$1\ ms = 1000000\ ns$$

$$1\ tick = 0.000001\ ms$$

$$ticks = t_{TransmissionDelay} [ms] / 0.000001 = t_{TransmissionDelay} [ticks]$$

8.5 Multicast

Multicasting offers the possibility to send data packets to more than one destination address – without multiplying bandwidth between camera and Multicast device (e.g. Router or Switch).

The data is sent out to an intelligent network node, an IGMP (Internet Group Management Protocol) capable Switch or Router and distributed to the receiver group with the specific address range.

In the example on the figure below, multicast is used to process image and message data separately on two different PC's.

Multicast Addresses:

For multicasting Bauer suggests an address range from 232.0.1.0 to 232.255.255.255.

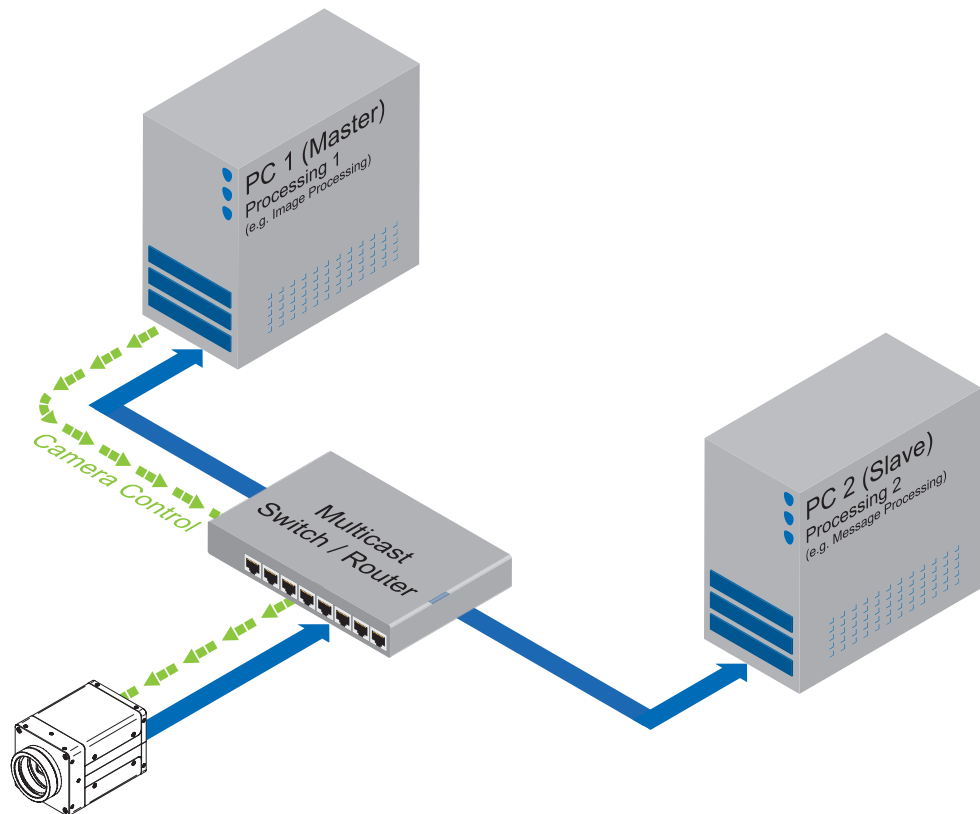

8.6 IP Configuration

8.6.1 Persistent IP

A persistent IP address is assigned permanently. Its validity is unlimited.

Notice

Please ensure a valid combination of IP address and subnet mask.

IP range:	Subnet mask:
0.0.0.0 – 127.255.255.255	255.0.0.0
128.0.0.0 – 191.255.255.255	255.255.0.0
192.0.0.0 – 223.255.255.255	255.255.255.0

These combinations are not checked by Baumer GAPI, Baumer GAPI Viewer or camera on the fly. This check is performed when restarting the camera, in case of an invalid IP - subnet combination the camera will start in LLA mode.

* This feature is disabled by default.

8.6.2 DHCP (Dynamic Host Configuration Protocol)

The DHCP automates the assignment of network parameters such as IP addresses, subnet masks and gateways. This process takes up to 12 s.

Once the device (client) is connected to a DHCP-enabled network, four steps are processed:

• DHCP Discovery

In order to find a DHCP server, the client sends a so called DHCPDISCOVER broadcast to the network.

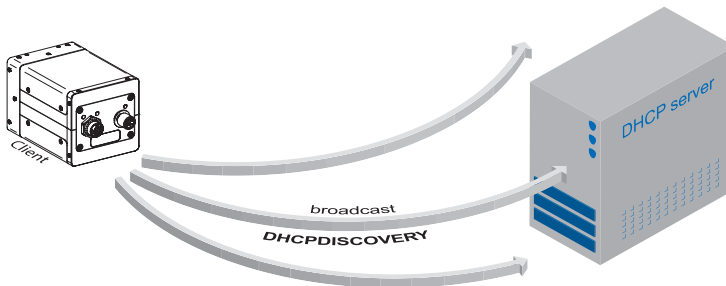

• DHCP Offer

After reception of this broadcast, the DHCP server will answer the request by a unicast, known as DHCPOFFER. This message contains several items of information, such as:

Information for the client	MAC address
	offered IP address
Information on server	IP address
	subnet mask
	duration of the lease

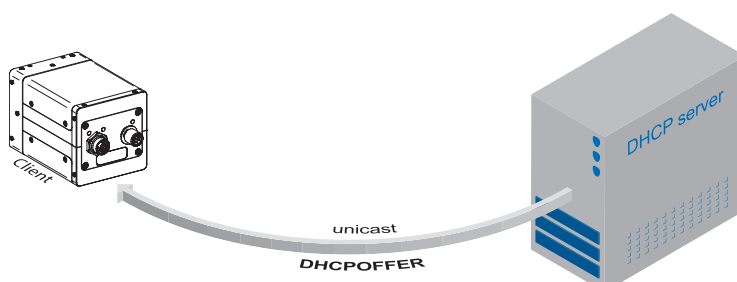

Internet Protocol:
On Baumer cameras IP v4 is employed.

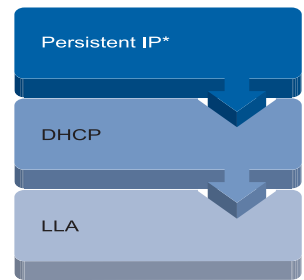

▲ Connection pathway for Baumer Gigabit Ethernet cameras:
The device connects step by step via the three described mechanisms.

DHCP:
Please pay attention to the DHCP Lease Time.

▪ DHCP Request

Once the client has received this DHCP OFFER, the transaction needs to be confirmed. For this purpose the client sends a so called DHCPREQUEST broadcast to the network. This message contains the IP address of the offering DHCP server and informs all other possible DHCP servers that the client has obtained all the necessary information, and there is therefore no need to issue IP information to the client.

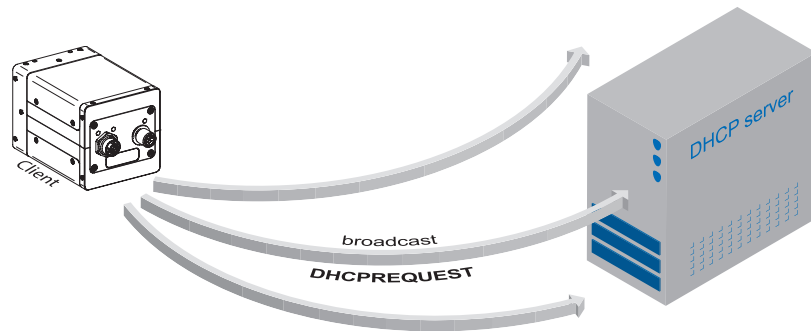

▪ DHCP Acknowledgement

Once the DHCP server obtains the DHCPREQUEST, a unicast containing all necessary information is sent to the client. This message is called DHCPACK.

According to this information, the client will configure its IP parameters and the process is complete.

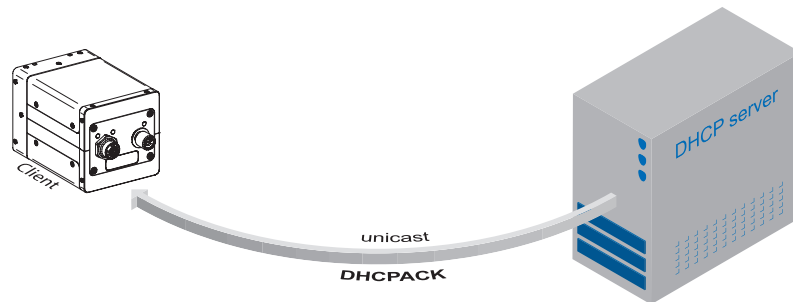

DHCP Lease Time:

The validity of DHCP IP addresses is limited by the lease time. When this time is elapsed, the IP configuration needs to be redone. This causes a connection abort.

8.6.3 LLA

LLA (Link-Local Address) refers to a local IP range from 169.254.0.1 to 169.254.254.254 and is used for the automated assignment of an IP address to a device when no other method for IP assignment is available.

The IP address is determined by the host, using a pseudo-random number generator, which operates in the IP range mentioned above.

Once an address is chosen, this is sent together with an ARP (Address Resolution Protocol) query to the network to check if it already exists. Depending on the response, the IP address will be assigned to the device (if not existing) or the process is repeated. This method may take some time - the GigE Vision® standard stipulates that establishing connection in the LLA should not take longer than 40 seconds, in the worst case it can take up to several minutes.

8.6.4 Force IP*)

Inadvertent faulty operation may result in connection errors between the PC and the camera. In this case "Force IP" may be the last resort. The Force IP mechanism sends an IP address and a subnet mask to the MAC address of the camera. These settings are sent without verification and are adapted immediately by the client. They remain valid until the camera is de-energized.

*) In the GigE Vision® standard, this feature is defined as "Static IP".

LLA:

Please ensure operation of the PC within the same subnet as the camera.

8.7 Packet Resend

Due to the fact, that the GigE Vision® standard stipulates using a UDP – a stateless user datagram protocol – for data transfer, a mechanism for saving the "lost" data needs to be employed.

Here, a resend request is initiated if one or more packets are damaged during transfer and – due to an incorrect checksum – rejected afterwards.

On this topic one must distinguish between three cases:

8.7.1 Normal Case

In the case of unproblematic data transfer, all packets are transferred in their correct order from the camera to the PC. The probability of this happening is more than 99%.

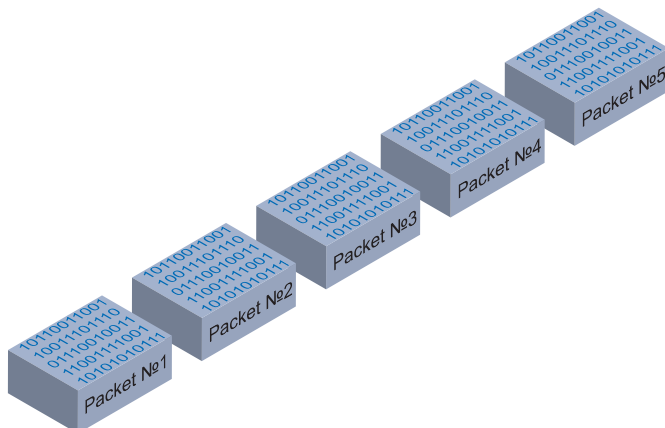

8.7.2 Fault 1: Lost Packet within Data Stream

If one or more packets are lost within the data stream, this is detected by the fact, that packet number n is not followed by packet number $(n+1)$. In this case the application sends a resend request (A). Following this request, the camera sends the next packet and then resends (B) the lost packet.

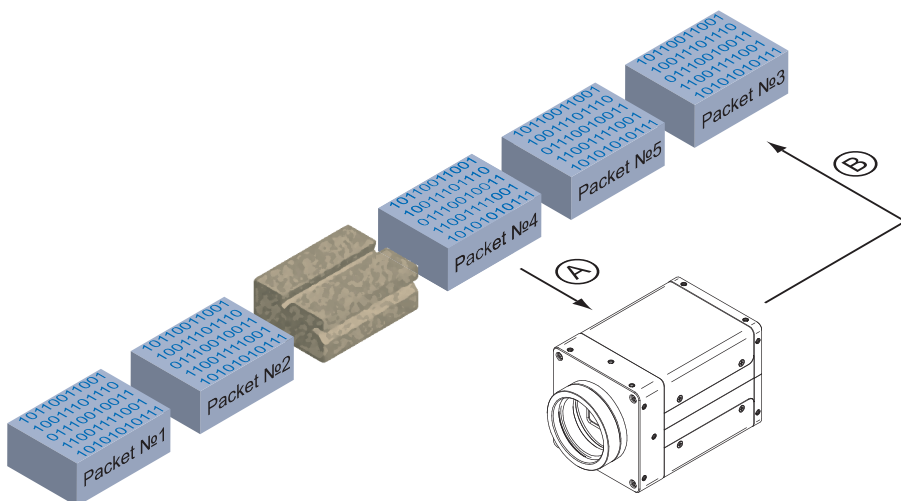

In our example packet no. 3 is lost. This fault is detected on packet no. 4, and the resend request triggered. Then the camera sends packet no. 5, followed by resending packet no. 3.

8.7.3 Fault 2: Lost Packet at the End of the Data Stream

In case of a fault at the end of the data stream, the application will wait for incoming packets for a predefined time. When this time has elapsed, the resend request is triggered and the "lost" packets will be resent.

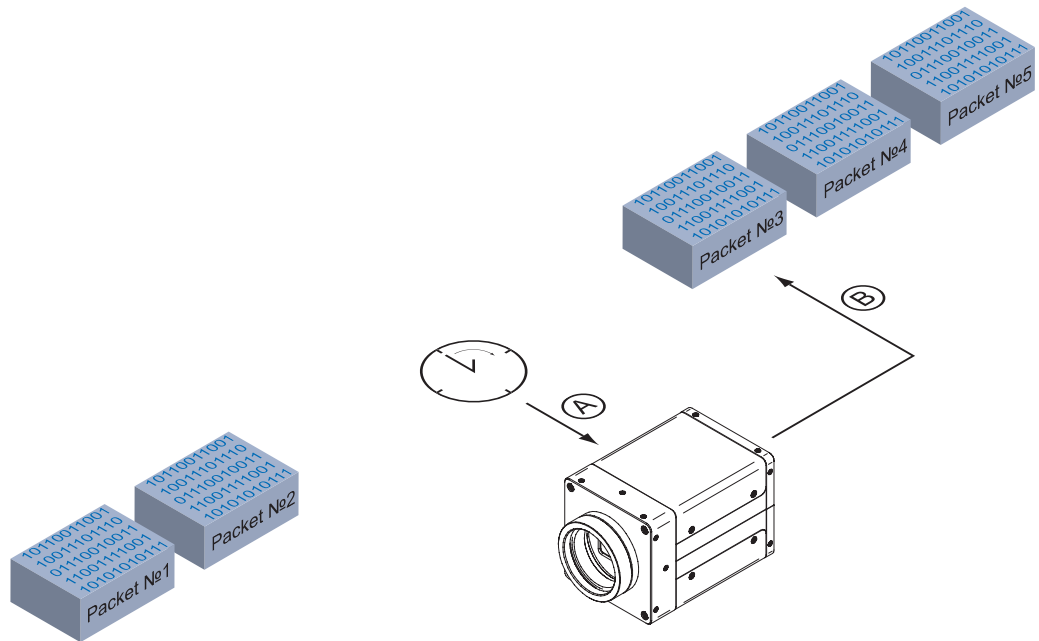

In our example, packets from no. 3 to no. 5 are lost. This fault is detected after the predefined time has elapsed and the resend request (A) is triggered. The camera then resends packets no. 3 to no. 5 (B) to complete the image transfer.

8.7.4 Termination Conditions

The resend mechanism will continue until:

- all packets have reached the pc
- the maximum of resend repetitions is reached
- the resend timeout has occurred or
- the camera returns an error.



Baumer Optronic GmbH

Badstrasse 30

DE-01454 Radeberg, Germany

Phone +49 (0)3528 4386 0 · Fax +49 (0)3528 4386 86

sales@baumeroptronic.com · www.baumer.com