

Operating instructions.

PosCon OXE7 – Edge measurement in a new dimension.



Contents

1	General information	4
1.1	Concerning the contents of this document	4
1.2	Intended use	4
1.3	Comments, notes, and warnings	4
2	Commissioning in 4 steps	5
2.1	Connection	5
2.2	Installation	6
2.3	Measuring mode	7
2.4	Measurement	10
2.5	Optional settings	10
3	Connection	11
3.1	Connection cable	11
3.2	Pin assignment and connection diagram	12
4	Installation	13
4.1	Mounting	13
4.2	Sensor reference levels	13
4.3	The reference surface	14
4.4	Sensor alignment	15
4.5	Standard installation	16
4.6	Angled installation	18
4.7	Practical zero point search	20
4.8	Installation accessories	21
5	Configuration via touch panel	23
5.1	Overview of control elements	23
5.2	Function tree	26
5.3	LIVE MONITOR	28
5.4	MEASUREMENT TYPE	29
5.5	EDGE HEIGHT / OBJECT HEIGHT / GAP DEPTH	33
5.6	OBJECT	33
5.7	PRECISION	33
5.8	FLEX MOUNT	34
5.9	MEASURING FIELD	38
5.10	DIGITAL OUT	43
5.11	SYSTEM	44
5.12	SETTING	45
6	Function and definition	47
6.1	Data sheet	47
6.2	Dimensions	52
6.3	Mode of operation	53
6.4	Object to be measured	55
6.5	Interfaces and outputs	57
6.6	Touch panel	65
6.7	Memory	65
7	Safety instructions and maintenance	66
7.1	General safety instructions	66
7.2	Sensor inscriptions	66

7.3	Influence of ambient light.....	68
7.4	Mechanical damage.....	68
7.5	Cleaning the sensors	68
7.6	Disposal	68
8	Error correction and tips.....	69
8.1	Effects of deviations in the inclination angle	69
8.2	The dependency of the measuring frequency	70
8.3	Error correction	72
9	Revision history	74

1 General information

1.1 Concerning the contents of this document

This manual contains information about the installation and commissioning of Baumer PosCon OXE7 edge sensors.

It is a supplement to the mounting instructions supplied with each sensor.



Read these operating instructions carefully and follow the safety instructions!

1.2 Intended use

The Baumer PosCon OXE7 sensor detects edges and outputs their position, distance, and center between edges.

It was especially developed for easy handling, flexible use, and precise measurement. The red light laser ensures that the light beam is always visible, which makes sensor alignment easier and minimizes installation errors. The sensor operates without a reflector.

1.3 Comments, notes, and warnings



NOTE

Provides helpful operation instructions or other general recommendations.



ATTENTION!

Indicates a possibly hazardous situation. If it is not avoided, minor or slight injuries can occur or the device can be damaged.

2 Commissioning in 4 steps

After the sensor is connected and installed, configure it via the display, selecting either the "Edge", "Width" or "Gap" function and performing the other application-specific settings/measurement type within these functions. The sensor is then ready for operation and outputs the measuring value in mm to the screen. Optionally, the measuring field can be limited or the switching output can be configured.

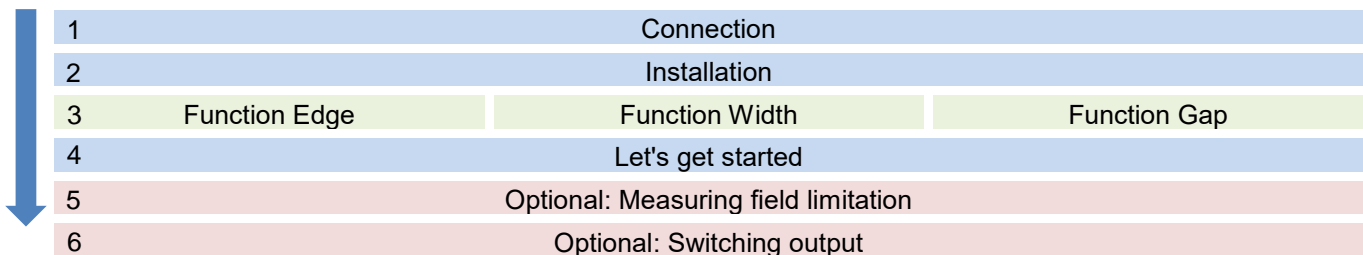

2.1 Connection

1 Connection

Connect the sensor according to the connection diagram. A shielded connection cable (8-pole M12) must be used.

When everything is correctly connected, the sensor starts up and the display lights up.

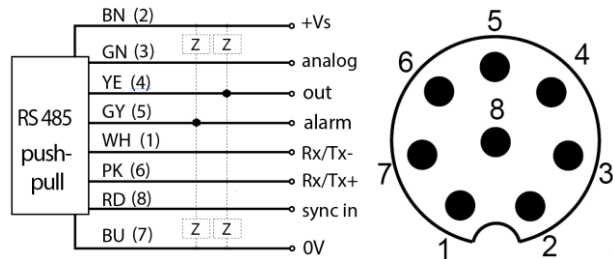

Key functions

ESC	= Back
ESC 2 sec.	= Main menu
UP	= Up/increase value
DOWN	= Down/decrease value
SET	= OK
SET 2 sec.	= Save value

Slide over all 4 keys:

---->	= Enables the panel if locked
<----	= Jump to run mode



Setting the language

The language is selected and confirmed by pressing SET for 2 seconds.

English
Deutsch
Italiano
Français

2.2 Installation

2 Standard installation

In standard installation, the sensor is mounted at a right angle to the reference surface or the object. The sensor is not taught into the reference surface so configuration is very easy and straightforward. This installation method is recommended even if the reference surface cannot be taught in for some reason or another.

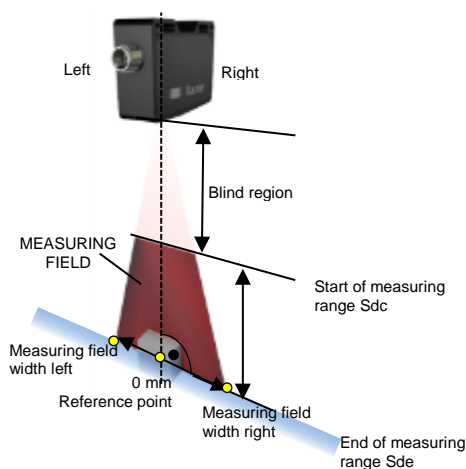

Align the sensor as accurately as possible at a right angle to the reference surface (background) or to the object (if there is no reference surface in the measuring field). The object must be within the measuring field, i.e. the distance from the sensor must be between the start of the measuring range S_{dc} and the end of the measuring range S_{de} . The reference surface can lie outside of the measurement field or can be non-existent, this situation is referred to as ege-to-infinity.

Angled installation

In angled installation, the sensor can be mounted at an angle of up to $\pm 30^\circ$ in relation to the reference surface. This installation method is used when space conditions do not allow any other installation option or the mounting angle is not known.

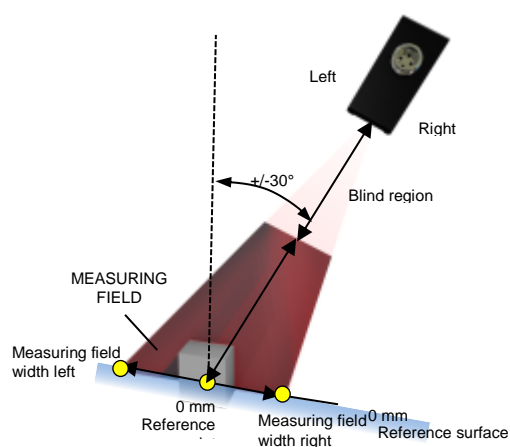

The sensor may be mounted at an angle inclined maximally 30° to the left or to the right of the reference surface (background) or to the object (if there is no reference surface in the measuring field).

Reference surface (background) and object must be within the measuring field.

NOTE



The "Edge L rise or Edge R rise" mode can be used as an aid to find the zero point. Now an object is slowly pushed toward the presumed zero point. The zero point is reached by the rising edge of the object when the value 0 mm is shown on the sensor display and the yellow LED switches.

2.3 Measuring mode

3a

Edge: Edge position (basic setting)

To perform edge measurement, select FUNCTION "EDGE" in the menu. Within EDGE the edge to be measured is defined in MEASUREMENT TYPE.

EDGE L RISE = First rising edge from the left

EDGE L FALL = First falling edge from the left

EDGE R RISE = First rising edge from the right

EDGE R FALL = First falling edge from the right

EDGE L RISE

EDGE L FALL

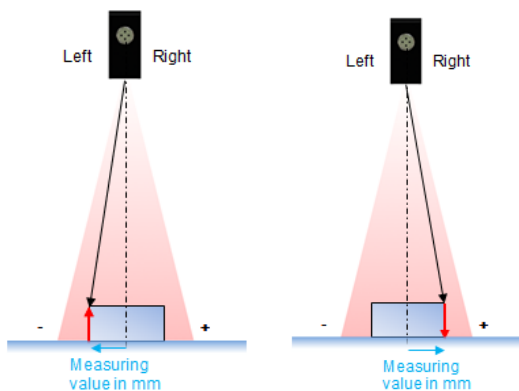

LIVE MONITOR	Angle in ° and Distance in mm
EDGE	MEAS TYPE
	Edge L rise
	Edge L fall
	Edge R rise
	Edge R fall
EDGE HEIGHT	Value in mm
OBJECT	Bright
	Dark
PRECISION	Standard
	High
	Very High
FLEX MOUNT	No
	Yes

EDGE R RISE EDGE R FALL

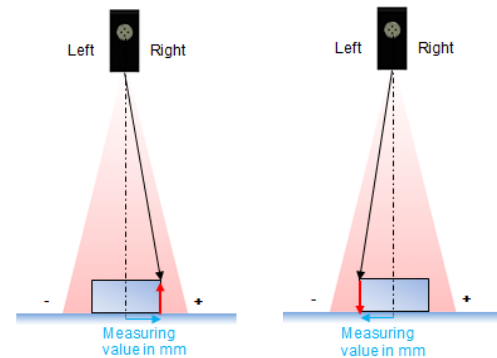

EDGE HEIGHT

Minimum height to be detected as an edge.

OBJECT

Selection of light or dark objects to optimize the measurement results.

PRECISION

For more reliable measurement results, the output values can be filtered with High and Very High.

FLEX MOUNT

If the sensor is mounted at an angle, FLEX MOUNT must be activated and the reference surface must be taught in.

1. Activate FLEX MOUNT
2. Align and confirm sensor or reference surface
3. When all conditions are met (see table on right), confirm by pressing Set for 2 seconds
4. Enter thickness of the auxiliary plate (if present)

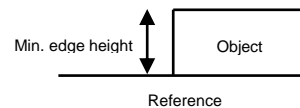

	Distance between sensor and reference surface
	Installation angle too large
	Reference surface too uneven
	Reference surface too small (<50 mm)

3b
WIDTH: Width measurement

To perform width measurement, select FUNCTION "WIDTH" in the menu. In WIDTH the desired output is selected in the MEAS TYPE menu.

OBJECT WIDTH = Distance between the first rising flank from the left and the first rising flank from the right.

OBJECT CENTER = Center between the first rising flank from the left and the first rising flank from the right in relation to the measuring axis of the sensor.

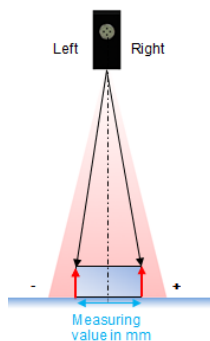
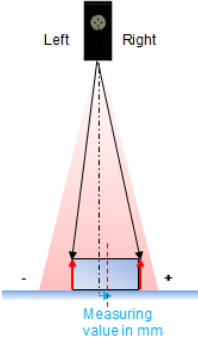
OBJECT WIDTH

OBJECT CENTER

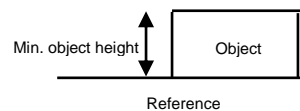
OBJECT HEIGHT

Minimum height of the object to be measured.

OBJECT

Selection of light or dark objects to optimize the measurement results.

PRECISION





For more reliable measurement results, the output values can be filtered with High and Very High.

FLEX MOUNT

If the sensor is mounted at an angle, FLEX MOUNT must be activated and the reference surface must be taught in.

1. Activate FLEX MOUNT
2. Align and confirm sensor or reference surface
3. When all conditions are met (see table on right), confirm by pressing Set for 2 seconds
4. Enter thickness of the auxiliary plate (if present)

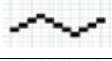
	LIVE MONITOR	Angle in ° and Distance in mm
WIDTH	MEAS TYPE	Width Center Width
	OBJ HEIGHT	Value in mm
	OBJECT	Bright Dark
	PRECISION	Standard High Very High
	FLEX MOUNT	No Yes

	Distance between sensor and reference surface
	Installation angle too large
	Reference surface too uneven
	Reference surface too small (<50 mm)

3C

GAP: Gap measurement

To perform gap measurement, select FUNCTION "GAP" in the menu. In GAP the measurement type to be activated is defined in the MEAS TYPE menu.

GAP WIDTH = Distance between the first falling flank from the left and the first falling edge from the right.

GAP CENTER = Center between the first falling flank from the left and the first falling flank from the right in relation to the measuring axis of the sensor.

	LIVE MONITOR	Angle in ° and Distance in mm
GAP	MEAS TYPE	Gap Center Gap
	GAP DEPTH	Value in mm
	OBJECT	Bright Dark
	PRECISION	Standard High Very High
	FLEX MOUNT	No Yes

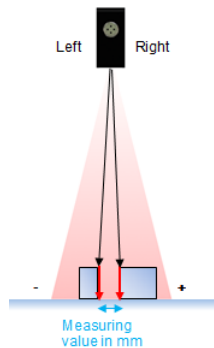
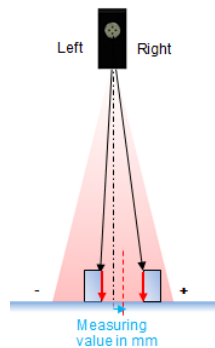
GAP WIDTH

GAP CENTER

GAP DEPTH

Minimum gap depth to be detected as an edge.

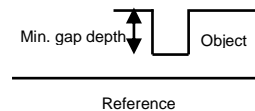
OBJECT

Selection of light or dark objects to optimize the measurement results.

PRECISION

For more reliable measurement results, the output values can be filtered with High and Very High.

FLEX MOUNT

If the sensor is mounted at an angle, FLEX MOUNT must be activated and the reference surface must be taught in.

1. Activate FLEX MOUNT
2. Align and confirm sensor or reference surface
3. When all conditions are met (see table on right), confirm by pressing Set for 2 seconds
4. Enter thickness of the auxiliary plate (if present)

	Distance sensor reference surface too large
	Installation angle too large
	Reference surface too uneven
	Reference surface too small (<50 mm)

2.4 Measurement

4 Let's get started

The sensor continuously outputs the measuring value in mm to the display and transmits it via the analog output to the control. Alternatively, the measuring value can also be retrieved from the RS485 interface.



2.5 Optional settings

5a Measuring field limitation (optional)

The measuring field can be changed via the MEASURING FIELD function. This function is required when there are objects in the measuring field which should not be detected.

- AUTO for limitation with a rectangle of automatic size
- Separate configuration of the single points of the field
LIMIT L, LIMIT RIGHT, OFFSET

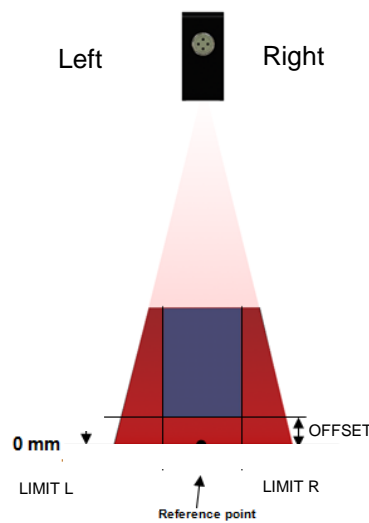

5b Switching output (optional)

The sensor is equipped with a switching output that can be configured as a threshold or as a window via the DIGITAL OUT function.

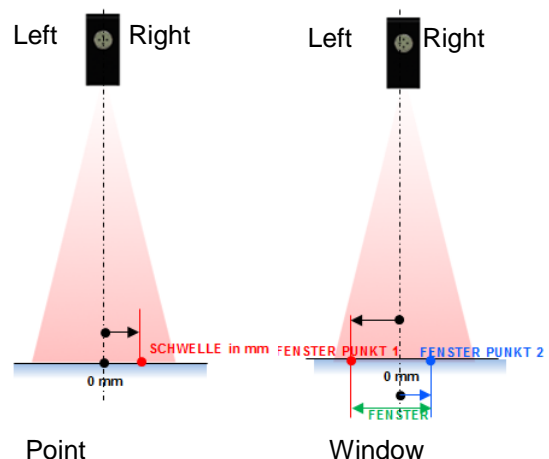

3 Connection

ATTENTION!

Incorrect supply voltage will destroy the device!

ATTENTION!

Connection, installation and commissioning may only be performed by qualified personnel.

ATTENTION!

The IP protection class is valid only if all connections are connected as described in the technical documentation.

ATTENTION!

Laser class 1 laser beam according to EN 60825-1:2014. This product can be operated safely without any additional safety precautions. Nevertheless direct contact between the eye and beam should be avoided.

3.1 Connection cable

An 8-pole, shielded connection cable (connector) is required.

Baumer connection cables with the following order codes are recommended:

- 10127844 ESG 34FH0200G (length 2 m, straight plug)
- 11053961 ESW 33FH0200G (length 2 m, angled plug)
- 10129333 ESG 34FH1000G (length 10 m, straight plug)
- 10170054 ESW 33FH1000G (length 10 m, angled plug)

Other cable lengths are available.

When the analog output is used, the cable length affects signal noise. Signal noise increases the longer the connection cable is.

Analog output I_OUT

Noise: 5.92 μ A (1 sigma) (10m cable and 680 Ohm)
 3.59 μ A (1 sigma) (2m cable and 680 Ohm)

Analog output U_OUT

Noise: 4.80 mV (1 sigma) (10m cable and 100 kOhm)
 3.03 mV (1 sigma) (2m cable and 100 kOhm)

We recommend that you use RS485 for high-precision applications.

3.2 Pin assignment and connection diagram

Pin	Color	Function	Description
Pin 1	WH = white	Rx/Tx-	RS 485 receive/transmit- (B)
Pin 2	BN = brown	+ Vs	Voltage supply (+15...+28 VDC)
Pin 3	GN = green	analog	Analog output (4...20 mA or 0...10V)
Pin 4	YE = yellow	out	Switching output, push-pull
Pin 5	GY = gray	alarm	Alarm output, push-pull
Pin 6	PK = pink	Rx/Tx+	RS485 receive/transmit+ (A)
Pin 7	BU = blue	0V	Ground GND
Pin 8	RD = red	sync in	Input synchronization

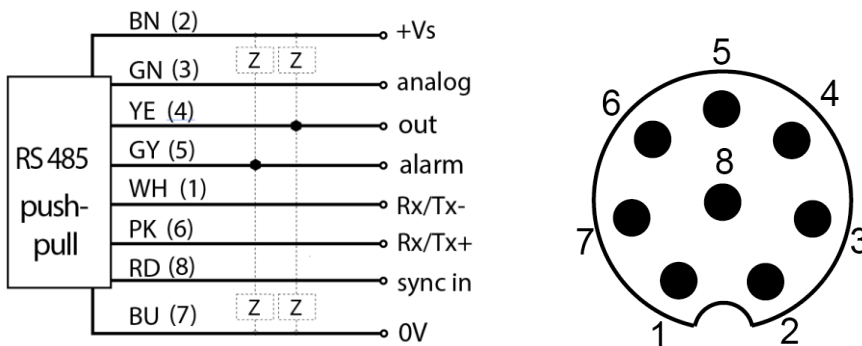
NOTE

We recommend that you connect unused cables to GND (0V).

4 Installation



ATTENTION!

Connection, installation and commissioning may only be performed by qualified personnel. Protect optical surfaces from moisture and dirt.

4.1 Mounting

The sensor has four mounting holes for flexible alignment and mounting. The use of 2 M4x35 screws is recommended for mounting. The tightening torque is max. 1.2 Nm.

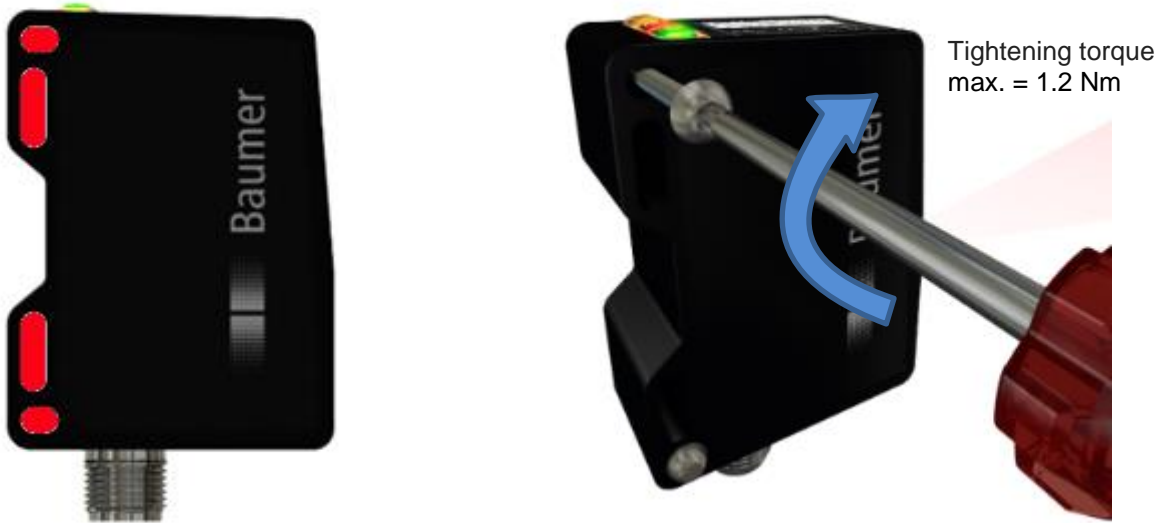

4.2 Sensor reference levels

To ensure easy alignment of the sensor during installation, the surfaces defined here are available: The laser beam of the sensor runs parallel (//) to level R3 and is at a right angle to levels R1 and R2. Levels R1, R2, and R3 serve as a reference for sensor alignment during installation. "Left" and "Right" designations are also important.

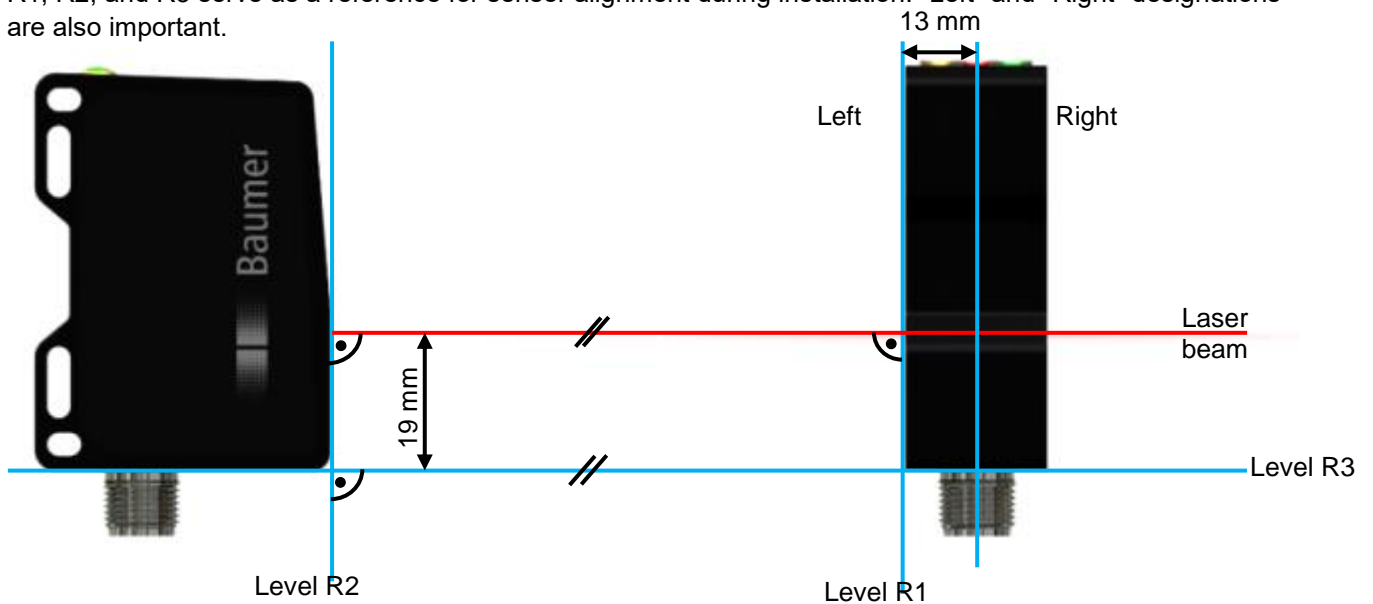

4.3 The reference surface

The measuring level where the object to be detected is located is referred to as the reference surface. It should be as even as possible; there must not be any edges in the measuring field which should not be detected (for exceptions see Section MEASURING FIELD).

If there is no reference surface as a measuring level, the sensor should be aligned to the object.

If the PosCon OXE7 sensor cannot be aligned at a right angle to the reference surface, the FLEX MOUNT function should be activated.

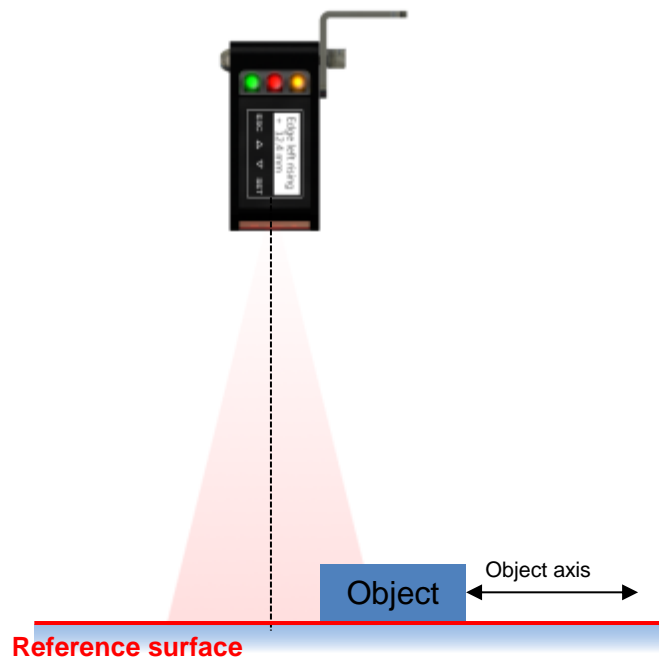

NOTE



The reference surface...

- can be within the measuring field (but doesn't have to be)
- must not have any edges in the sensor measuring range
- should be as even as possible
- can be taught in using the FLEX MOUNT function

4.4 Sensor alignment

As standard the sensor is mounted at a right angle (90°) to the reference surface or the object (standard installation), but it can also be mounted at an angle of up to 30° (angled installation).

To get the most accurate measurements possible in angled installation, the inclination angle of the sensor has to be taught in, see Section FLEX MOUNT.

The distance from the reference surface or the object must not exceed the "End of measuring range" value on the measuring axis.

**Note**

Angle deviations can affect measuring accuracy (see Section Alignment errors).

**Tip**

To facilitate sensor alignment, LIVE MONITOR monitor can be used as an aid. LIVE MONITOR continuously outputs the currently measured angle and the distance from the reference surface.

4.5 Standard installation

In standard installation, the sensor is mounted at a right angle (90°) to the reference surface or the object (when there is no reference surface).

On reference level



on object



4.5.1 Definition of the measuring field with standard installation

The important terms "Left" and "Right" are to be regarded respectively from the viewpoint of the plug.

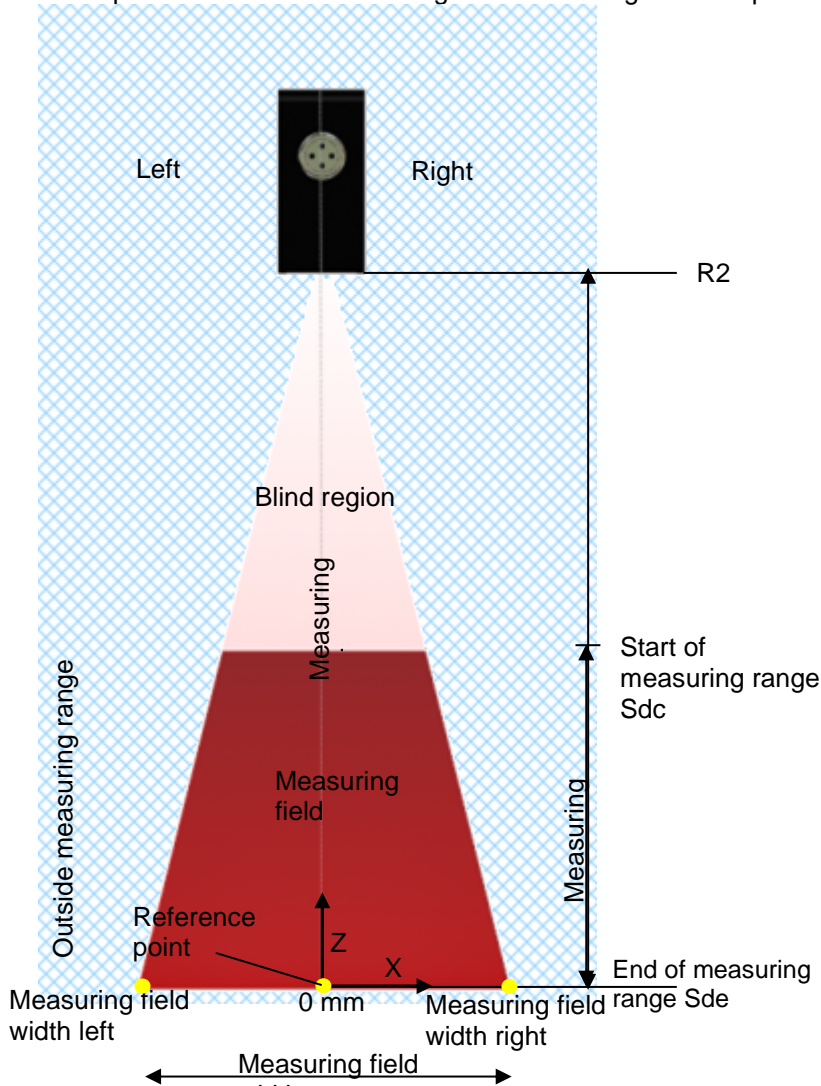

NOTE
 For further explanations, see Section "Function and definition" - > "Interfaces and output-> "Analog signal output".

4.5.2 Blind region

The region up to the start of measuring range S_{dc} is called the blind region, i.e. the sensor cannot detect any objects there.

Nevertheless, placing an object there should be avoided since the resulting shadowing of objects could produce incorrect measuring values.

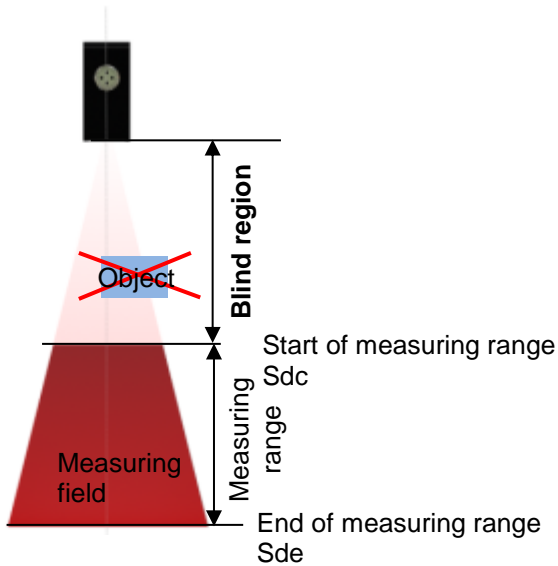

4.6 Angled installation

Compared to standard installation, the sensor can be mounted at an arbitrary inclination angle up to $\pm 30^\circ$.

This is particularly useful when space conditions do not allow any other installation option. See Section FLEX MOUNT.

The object must be within the measuring field.

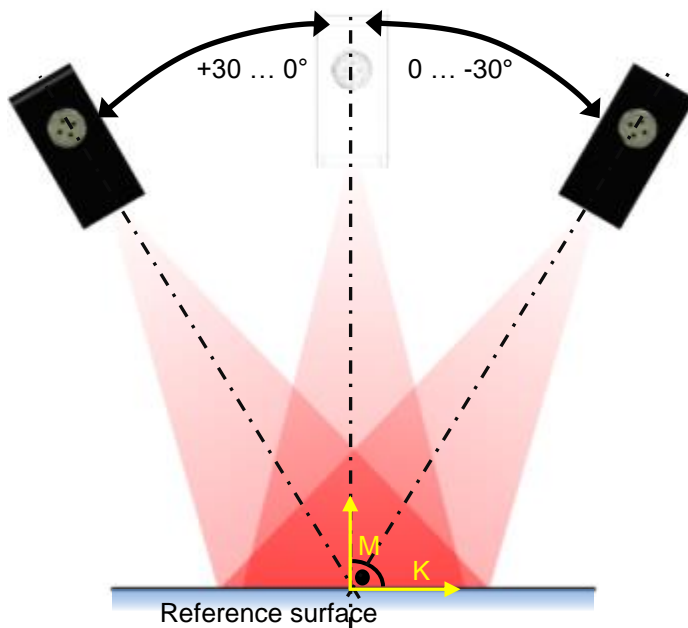

4.6.1 Definition of the measuring field with angled installation

At the maximum allowable inclination angle of $\pm 30^\circ$, the sensor measures objects and edges within the measuring field defined below. The important terms "left" and "right" are to be regarded respectively from the viewpoint of the sensor, and in the following figures from the viewpoint of the connector side of the sensor. After activation of the FLEX MOUNT function, the sensor axis is no longer relevant. The measurement coordinate system is now represented by the M and K axes. The measurement value is now the distance on an edge to the M axis.

Example with -30° inclination

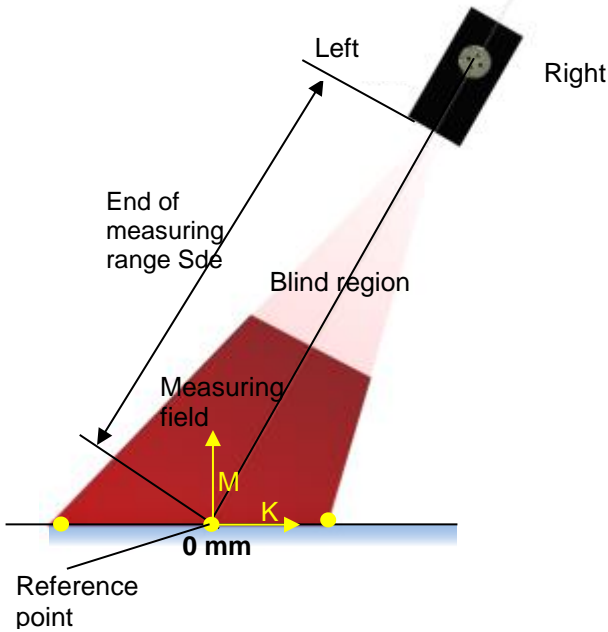

Example with -20° inclination angle

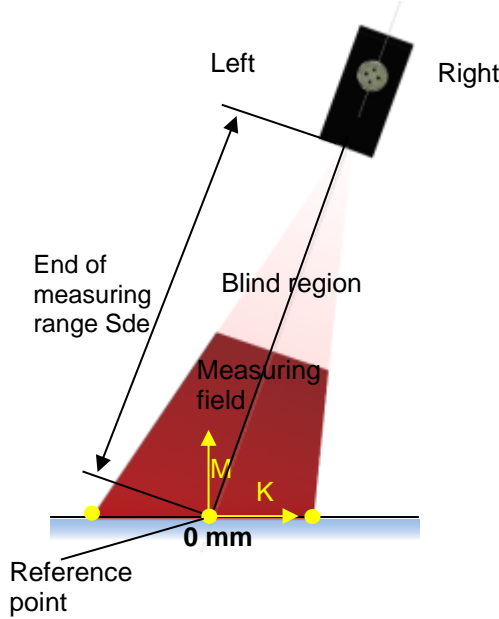

Example with 15° inclination

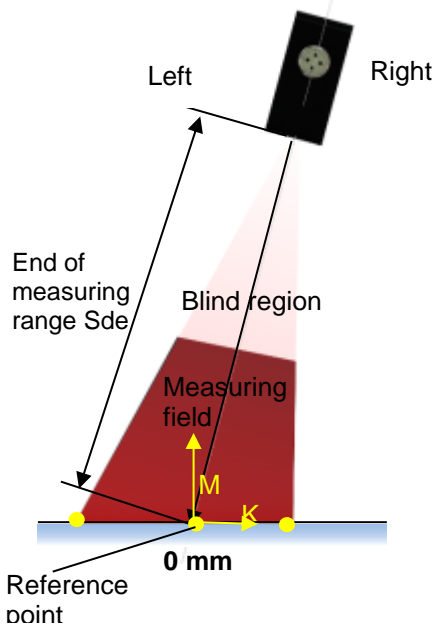

Example with 10° inclination

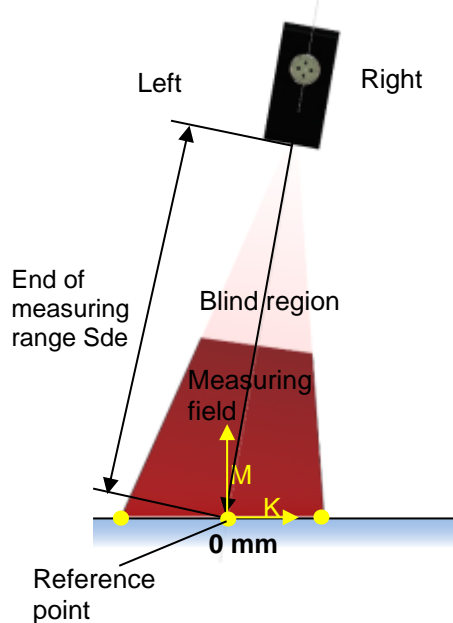

4.6.2 For weak reflection

If the object is a weak reflector there are several things that can be tried to improve the detection::

- use the object dark mode, this increases the exposure time
- Modify the mounting angle, as shown below, this reduces the angle between emitted laser light and the acceptance angle of the detector. This is recommended for diffuse weak reflectors.
- Change the search direction of an edge to go from the background (or reference plane) to the object.
- Define a measurement field (using the offset and limit function) that only contains the minimal area of interest around the sensor, this leads the sensor to ignore unwanted reflections

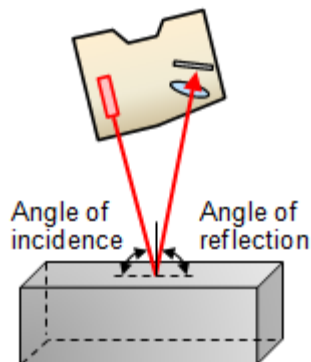

4.6.3 To avoid direct reflection

If there is a risk for a direct/specular reflection that can saturate the camera image, it is recommended to tilt the sensor, so that the direct reflection from the laser light cannot hit the camera. This is illustrated in the image below. The left situation shows the standard mounting procedure, while the right illustration shows the mounting to avoid direct reflections from the laser into the camera.

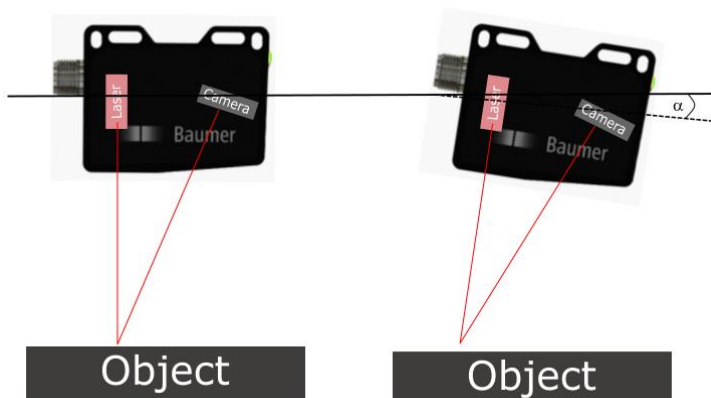

4.7 Practical zero point search

In case of angled installation, the zero point (0 mm) of the K axis shifts out of the center of the red visible laser line.

NOTE

The "Edge L rise or Edge R rise" mode, for example, can be used as an aid to find the zero point. Now an object is slowly pushed toward the presumed zero point.

The zero point is reached by the left rising edge of the object when the value 0 mm

is shown on the sensor display and the yellow LED switches.



4.8 Installation accessories

To ensure optimal mounting, various mounting brackets are available as an accessory. These brackets fit the mounting holes of the sensor exactly. The sensor can be shifted and adjusted inside the mounting hole.

4.8.1 Mounting kit for standard installation Order no. 11120705

With the mounting bracket for standard installation, the sensor can be mounted quickly and easily at a 90° angle to the reference surface.

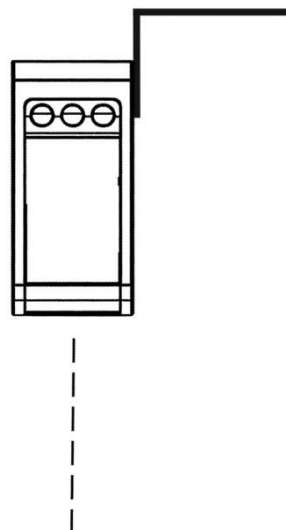

Mounting kit 11120705

Contents of this set:

- 90° mounting bracket
- Threaded plate
- 2x spherical head screw M4x35 Torx
- 1x Torx tool T20

4.8.2 Mounting kit for $\pm 30^\circ$ angled installation with horizontal mounting Order no. 11126836

If it is not possible to position the sensor at a right angle to the reference surface, the sensor can be mounted at an inclination angle of $\pm 30^\circ$ with this mounting kit.

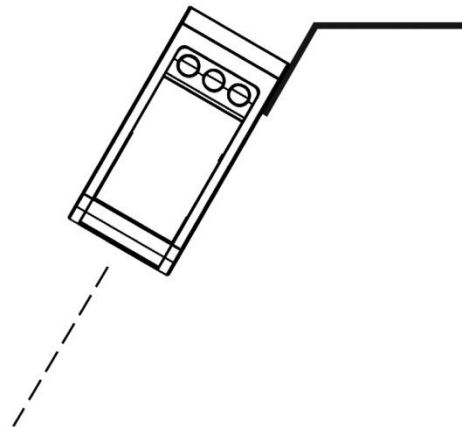

Mounting kit 11126836

Contents of this set:

- 30° mounting bracket, horizontal
- Threaded plate
- 2x spherical head screw M4x35 Torx
- 1x Torx tool T20

4.8.3 Mounting kit for $\pm 30^\circ$ angled installation with horizontal mounting Order no. 11126837

If it is not possible to position the sensor at a right angle to the reference surface, the sensor can be mounted at an inclination angle of $\pm 30^\circ$ with this mounting kit.

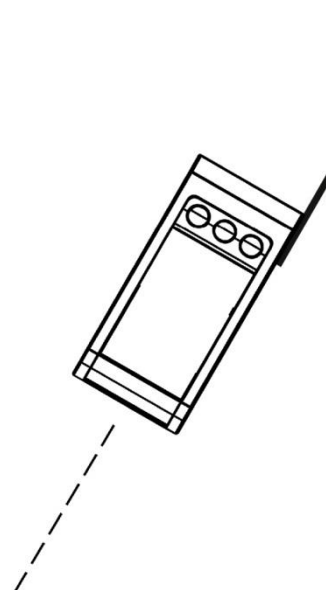

Mounting kit 11126837

Contents of this set:

- 30° mounting bracket, vertical
- Threaded plate
- 2x spherical head screw M4x35 Torx
- 1x Torx tool T20

5 Configuration via touch panel

5.1 Overview of control elements

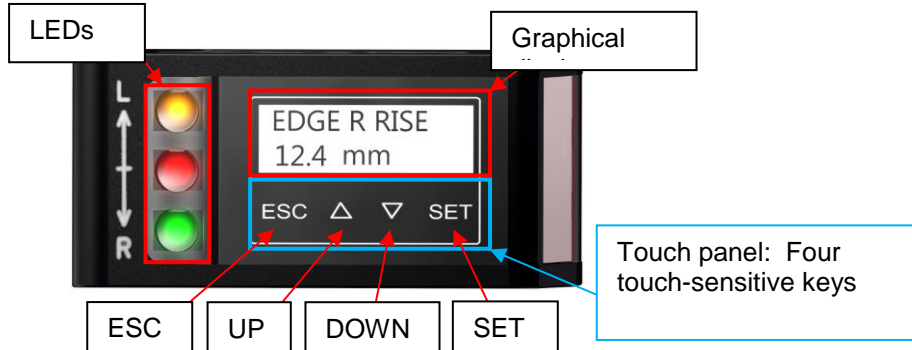

5.1.1 Display modes

	Run mode The sensor is in run mode, the measuring value is displayed in large characters.
	Main menu In the main menu the active mode is displayed at the top, and the measuring value is displayed at the bottom.
	Scroll bar The square indicates the position in the menu. The next menu item can be accessed using the arrow keys.
	Change value If the function/mode at the top is displayed on a black background, the value of the bottom line can be adjusted using the UP/DOWN keys and saved with SET.
	Process successful The display background lights up green: Value successfully saved
	Error The display background lights up red: Error during the save process or wrong value entered.
	Setting mode When the sensor is in setting mode the display background lights up blue.
	Keys locked If this symbol is on the left side of the screen, then the touch panel is locked for operation.
	FLEX MOUNT activated When FLEX MOUNT is activated, this angle symbol appears on the left side of the screen.
	Rectangular measuring field activated This symbol appears on the left side of the screen when the measuring field is rectangular (AUTO).

5.1.2 Functions of the individual keys

Key	Pressed briefly	Pressed >2 s.
ESC	Back	Jump to main menu
UP	Up/increase value	
DOWN	Down/decrease value	
SET	OK	Save new value*

*Only in the setting menu when the top line is displayed on a black background (change value)

5.1.3 Locking the touch panel

The keys on the control panel are locked when they are not pressed for 5 minutes. A key symbol appears, and the measuring value is displayed in large lettering.

When it is pressed, the following text appears:

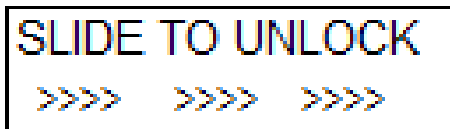

To re-enable the touch panel, it is required to quickly slide a finger over all four keys from left to right (slide over ESC, UP, DOWN, and SET).



When controlled via RS-485:

When the sensor is controlled via RS-485, it cannot be operated via the display at the same time; the keys are deactivated. When the keys are pressed, the following text appears on the display:

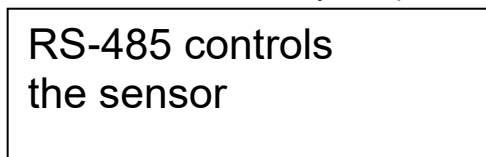

Locking via RS-485 command:

The sensor keys can be locked with a RS-485 command. This locking remains activated even if the sensor is no longer controlled via RS-485. The keys must be unlocked with a RS-485 command. When the locked keys are touched, the following text appears on the display:

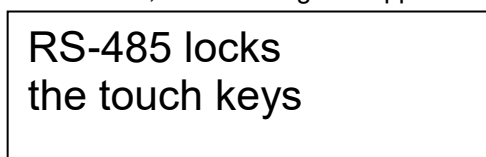

5.1.4 Further key functions

Action	Reaction
Slide over all keys from left to right	Unlock locked touch panel Only if touch panel is locked
Slide over all keys from right to left	Jump directly to run mode Can be used from any menu

5.1.5 LEDs on the sensor

LED	Lights up	Flashes
Yellow	out1 activated Adjustable switching output1 activated	-
Red	out2 activated Alarm or error. Object to be measured outside measuring field or invalid received signal (e.g. soiling)	Insufficient excess gain Object just under the measuring range limit or insufficient received signal (e.g. soiling)
Green	Supply voltage Sensor ready for operation	Short circuit Check connection



5.2 Function tree

The menu that can be accessed via the touch panel is shown below.



LIVE MONITOR		Angle in ° and Distance in mm		
FUNCTION	EDGE	MEAS TYPE	Edge L rise Edge L fall Edge R rise Edge R fall	
		EDGE HEIGHT	Value in mm	
		OBJECT	Bright Dark	
		PRECISION	Standard High Very High	
		FLEX MOUNT	No Yes	
				TEACH REF
				THICKNESS REF
WIDTH		Angle in ° and Distance in mm		
		MEAS TYPE	Width Center Width	
		OBJ HEIGHT	Value in mm	
		OBJECT	Bright Dark	
		PRECISION	Standard High Very High	
		FLEX MOUNT	No Yes	
				TEACH REF
				THICKNESS REF
GAP		Angle in ° and Distance in mm		
		MEAS TYPE	Gap Center Gap	
		GAP DEPTH	Value in mm	
		OBJECT	Bright Dark	
		PRECISION	Standard High Very High	
		FLEX MOUNT	No Yes	
				TEACH REF
				THICKNESS REF

FIELD OF VIEW △ ▽	AUTO	Height Width; Value height in mm
	LIMIT LEFT	Value in mm
	LIMIT RIGHT	Value in mm
	OFFSET	Value in mm
	FIELD OF VIEW	Set max values
DIGITAL OUT △ ▽	DIGITAL OUT	Point / Window
	SWITCH POINT	Value in mm
	WINDOW P1	Value in mm
	WINDOW P2	Value in mm
	OUTPUT LEVEL	Active high / Active low
SYSTEM △ ▽	RS485 BAUD	38400 57600 115200
	RS485 ADDR	number
	DISPLAY LIGHT	OFF after 5min OFF after 10min OFF after 20min Always ON
	SENSOR INFO	SENSOR TYPE
		SERIAL NUM
	LANGUAGE	English Deutsch Inglese Français
	RESET	Factory set
SETTINGS △	APPLY	Setting 1 Setting 2 Setting 2
	STORE	Setting 1 Setting 2 Setting 2
	SHOW ACTIVE	Values
	SHOW SETTING 1	Values
	SHOW SETTING 2	Values
	SHOW SETTING 3	Values

5.3 LIVE MONITOR

The installation conditions can be checked using LIVE MONITOR. The sensor continuously measures the angle and the distance of the optical axis from the measuring level and outputs the values. This makes installation much easier and also points out installation errors.



Measured angle in ° (right angle to reference surface = 0°)

Distance from the reference

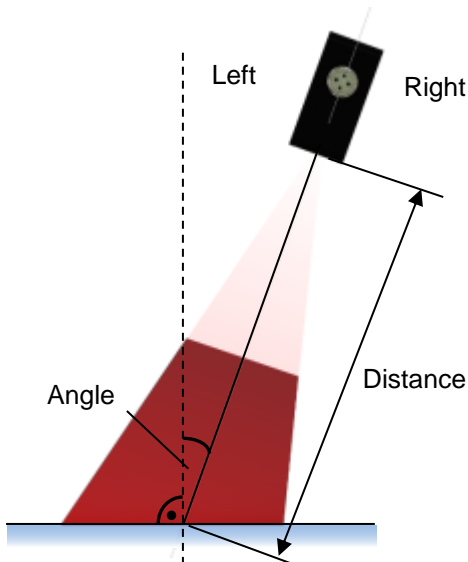

 **NOTE**
An angle of 0° means that the sensor is at a right angle to the reference surface.

5.4 MEASUREMENT TYPE

The detected edges can be output in various ways, for example as simple edges (distance of the desired edge in mm from the center of the measuring range) or also the width or center of an object as a value in mm, calculated from two edges.

The measuring modes and their calculation are described below.

5.4.1 Edge L rise

The edge of the first rising flank from the left.

Distance in mm measured from the center of the measuring range of the sensor to the edge.

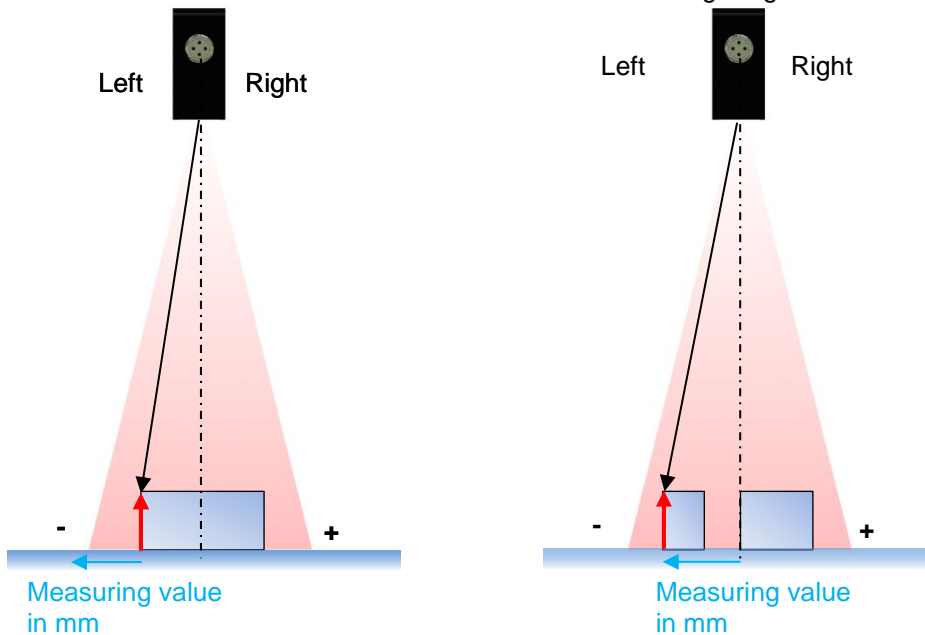

5.4.2 Edge L fall

The edge of the first falling flank from the left.

Distance in mm measured from the center of the measuring range of the sensor to the edge.

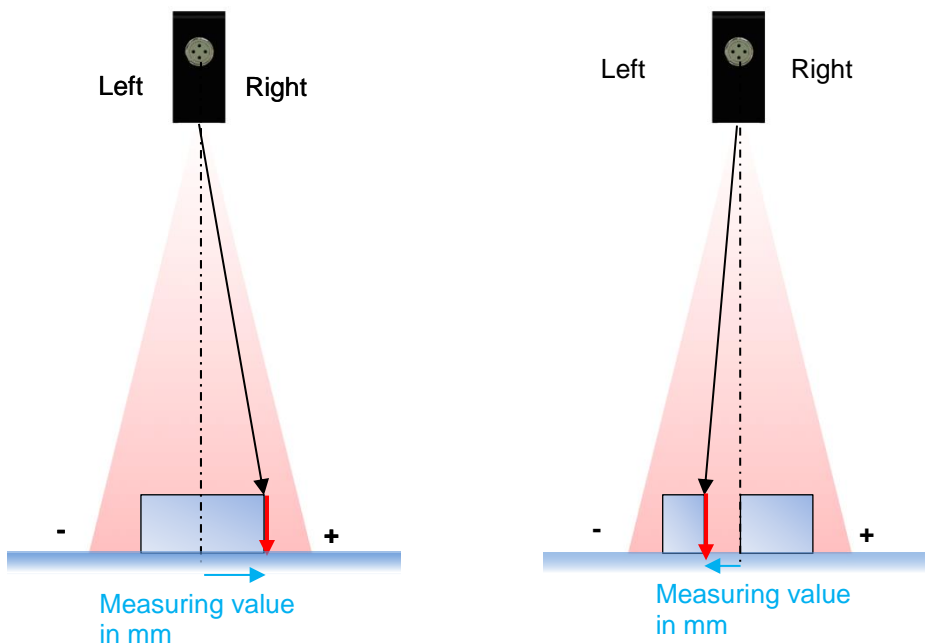

5.4.3 Edge R rise

The edge of the first rising flank from the right.

Distance in mm measured from the center of the measuring range of the sensor to the edge.

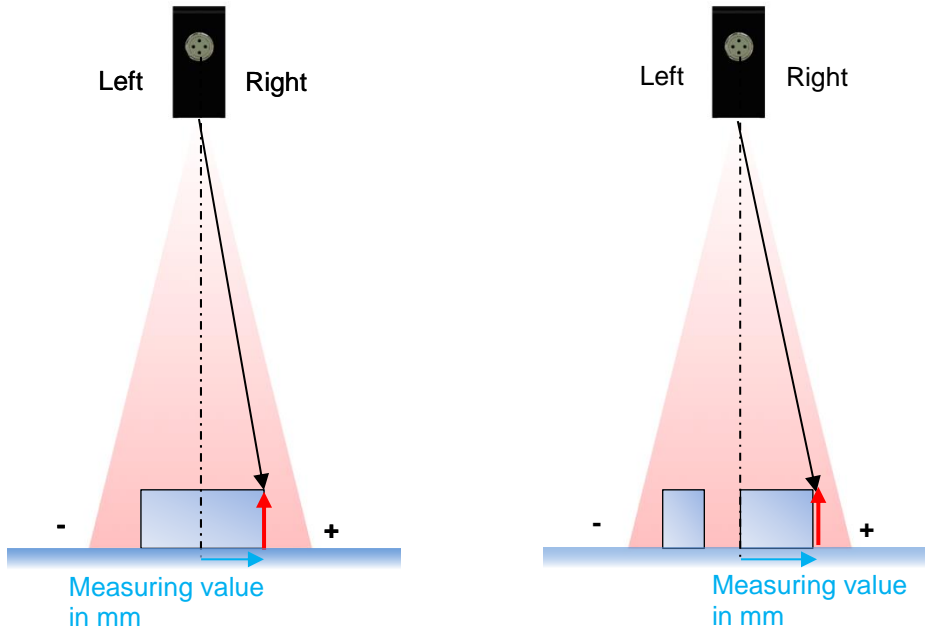

5.4.4 Edge R fall

The edge of the first falling flank from the right.

Distance in mm measured from the center of the measuring range of the sensor to the edge.

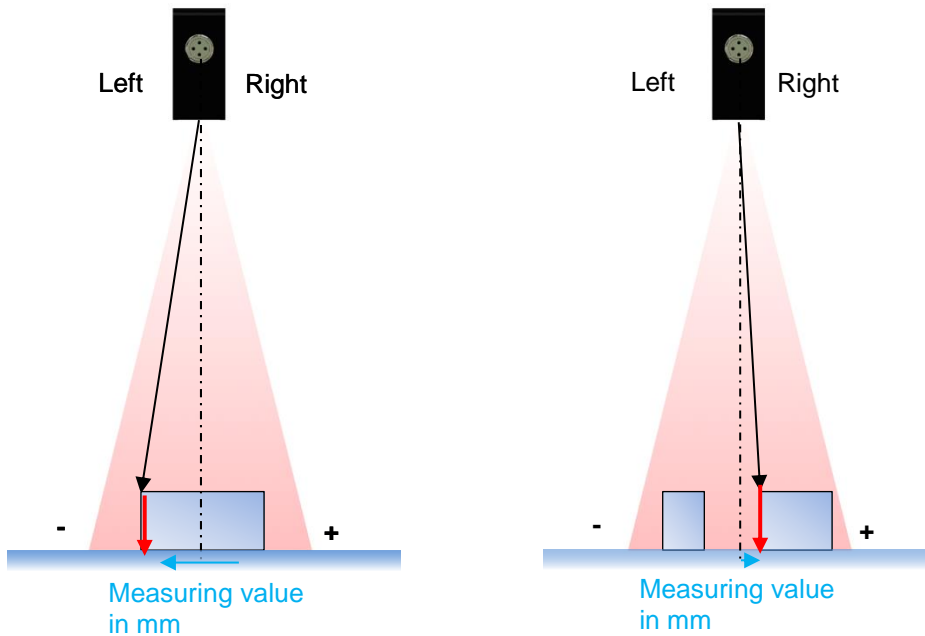

5.4.5 Object width

Distance of the "Edge L rise" from "Edge R rise".
Width measurement of the object in mm.

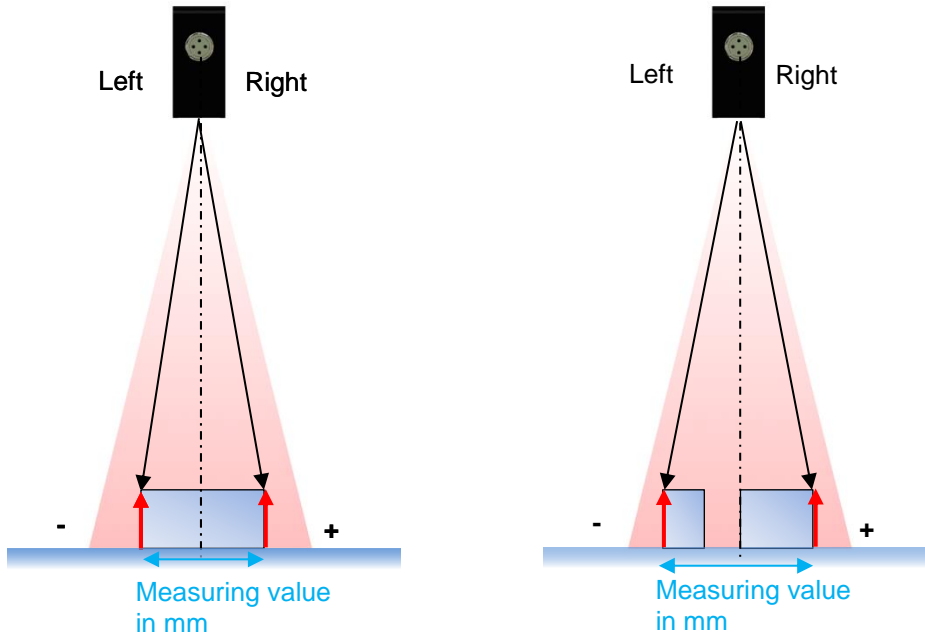

5.4.6 Object center

Average of the "Edge L rise" and the "Edge R rise".
Output of the distance from the center of an object to the center of the measuring range in mm.

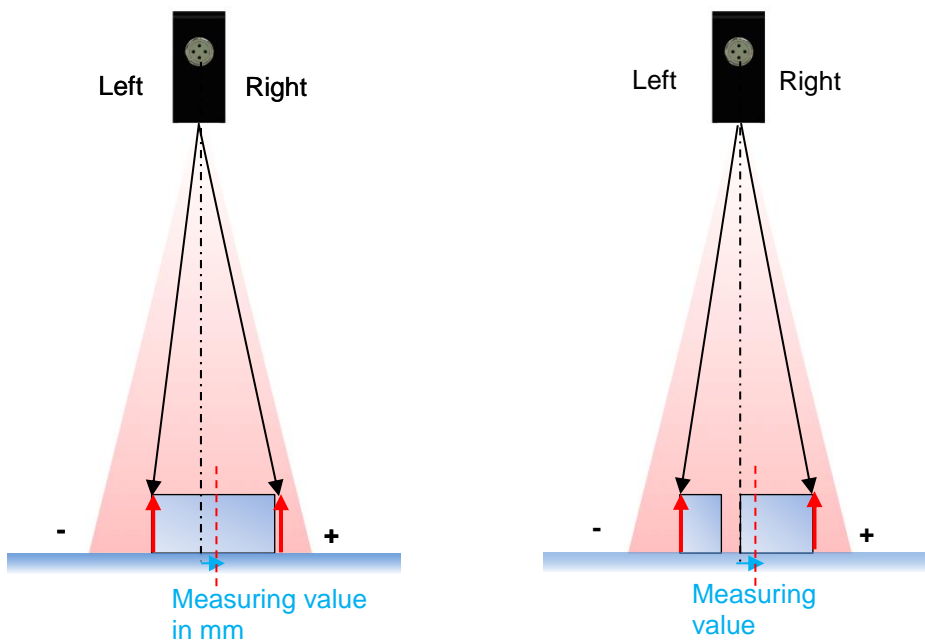

5.4.7 Gap width

Distance of the "Edge L fall" from "Edge R fall".
Measurement of a gap between two edges in mm.

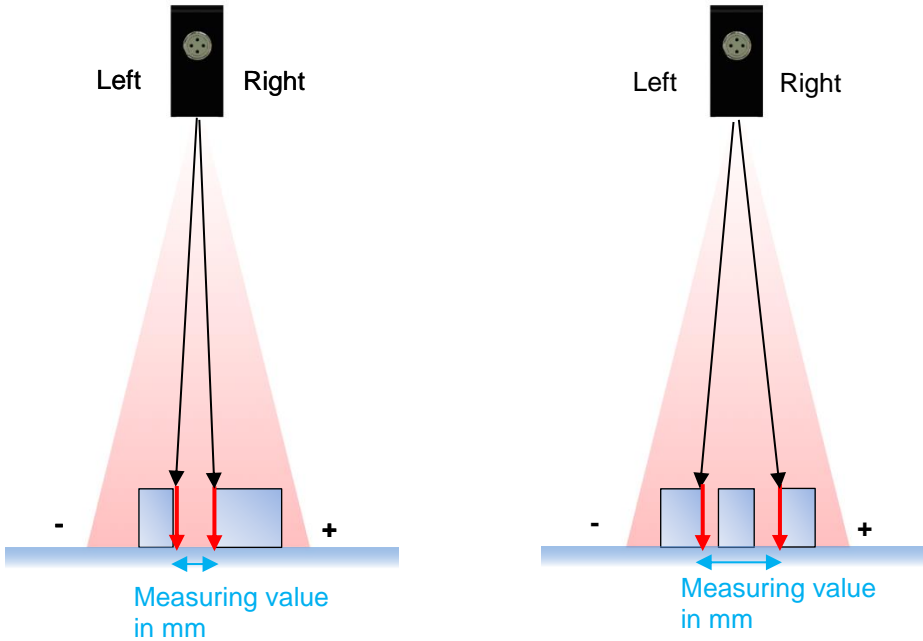

5.4.8 Gap center

Average of the "Edge L fall" and the "Edge R fall".
Output of the distance from the center of a gap to the center of the measuring range in mm.

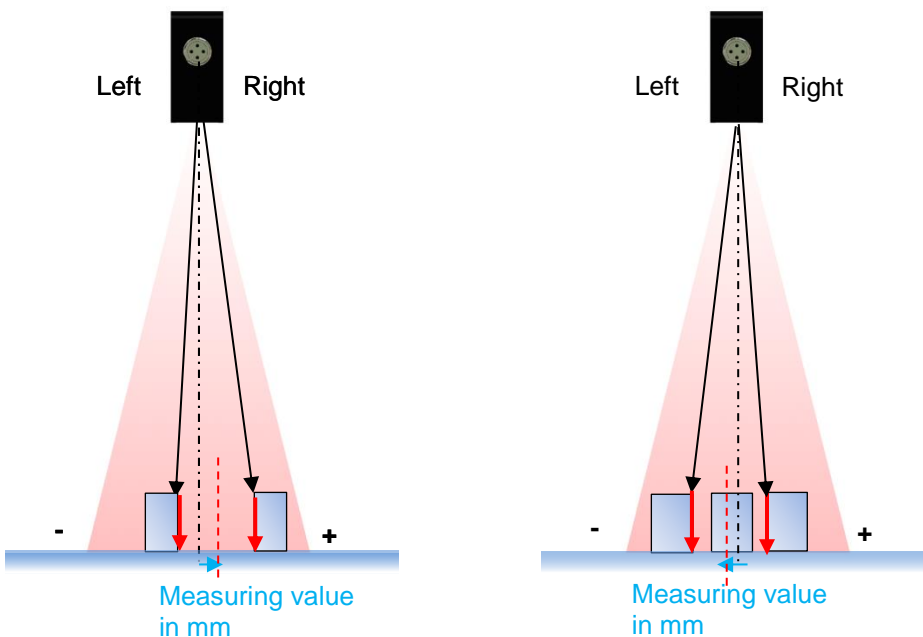

5.5 EDGE HEIGHT / OBJECT HEIGHT / GAP DEPTH

The minimum height of the step of the object to be detected by the sensor as an edge. If the step is smaller than the value entered here, it is not detected as an edge. As standard, this height is set to 4 mm.

This threshold is set in 1 mm steps, where 0 mm corresponds to the smallest adjustable edge height.

5.6 OBJECT

To improve sensitivity to dark objects, the exposure time can be increased. At the same time, the measuring repeat time changes as well.

Object: Light (reflectivity > 18%)

Pulse duration	Short ¹
----------------	--------------------

Object: Dark (reflectivity > 18%)

Pulse duration	Long ¹
----------------	-------------------

5.7 PRECISION

Time filtering with median and average is used to filter out interference in the sensor and smoothen the output signal.

Average

Moving averages (also known as rolling or running averages) reduce the existing variation in a series. Therefore they are frequently used to smoothen series.

Median

The median refers to a line between two halves. In statistics the median divides a distribution into two halves. Compared to the arithmetic mean, also known as average, the median has the advantage of being more resistant to freak values (extremely deviating values).

The following filter values can be selected:

Standard = No Filter

High

Very high

The filter details can be found in the data sheet in Section 6.1.

The higher precision is set, the more response and release time are increased. The measuring frequency, on the other hand, is not dependent on the selected filtering.

Depending on the circumstances in the customer application, it is possible to improve repeat accuracy up to a factor of 4 by filtering.

¹ In accordance with data sheet in Section 6.1.

5.8 FLEX MOUNT

The sensor can be installed at an inclination of up to 30° . To adapt the coordinate system of the sensor to this circumstance, the new angle must be saved in the sensor memory.

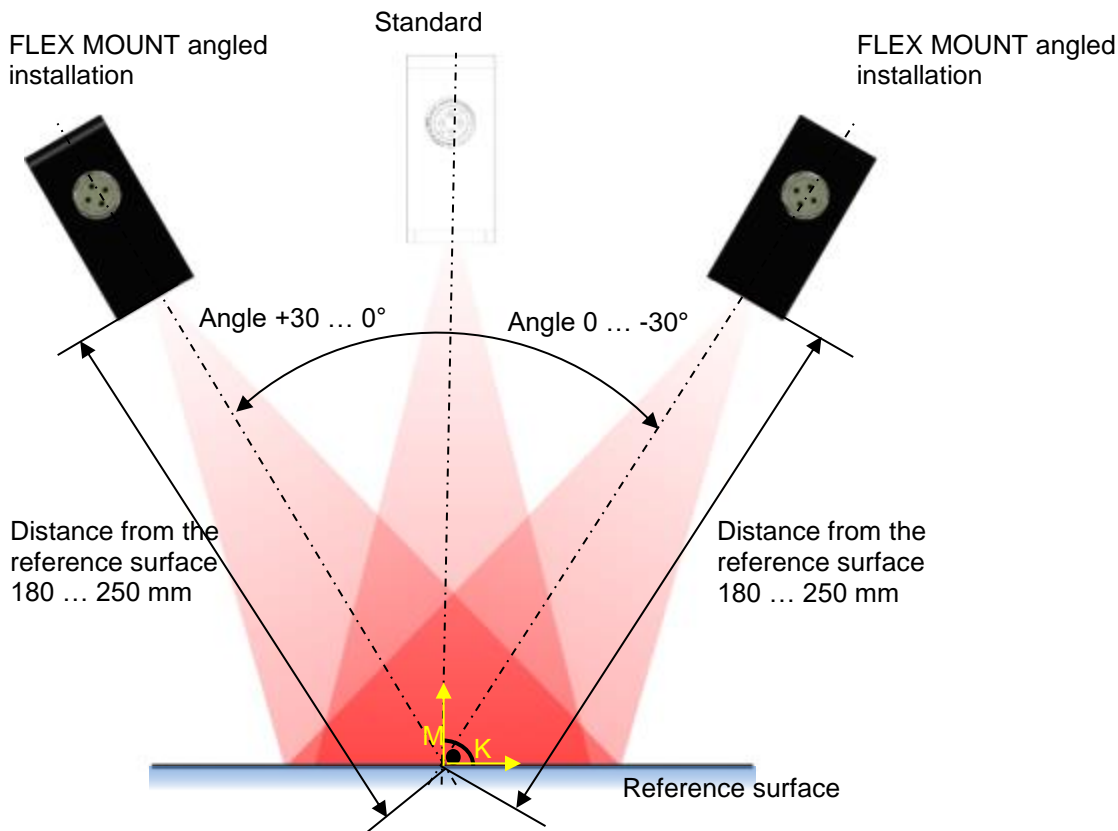

With FLEX MOUNT the inclination angle and the distance from the reference surface are automatically detected and saved in the sensor memory so the coordinate system can be rotated correctly. It is important that the taught-in surface is even and covers as much of the entire measuring range of the sensor as possible.

This function is required when...

- the angle to the reference surface is unknown
- a standard installation (right angle to the reference surface or the object) is not present
- the reference surface is to be automatically taught in and shifted
- the required accuracy of the measurement results will not be achieved otherwise
- the background is to be suppressed

Effects

- The coordinate system is rotated by the current inclination angle
- The reference surface is taught in; the reference point is no longer valid
- Objects behind the reference surface are ignored
- The axes are no longer referred to as X and Z, but as M and K
- When the FLEX MOUNT function is activated, this is indicated by an angle symbol  on the left side of the display

5.8.1 No

"No" deactivates FLEX MOUNT, the sensor can be remounted in standard installation.
 If FLEX MOUNT is not activated, angle 0° and distance "End of measuring range Sde" are set.

The angle symbol  disappears from the display.

5.8.2 Yes

FLEX MOUNT is activated in this menu item when the sensor is to be mounted at an angle.

Next, "Place the reference (REF)" is output by the sensor and then the sensor must be aligned to the reference surface (or the auxiliary plate if there is no reference surface).

Auxiliary plate

To compensate for unevenness and increase accuracy, a flat temporary auxiliary plate can be used for this process. It is placed on the reference surface during teaching-in and removed after the process.

This plate should be as even as possible and must cover the "minimum reference surface length". The plate must be positioned parallel to the reference surface below it. The thickness of this plate is not important as long as it is within the measuring field of the sensor.

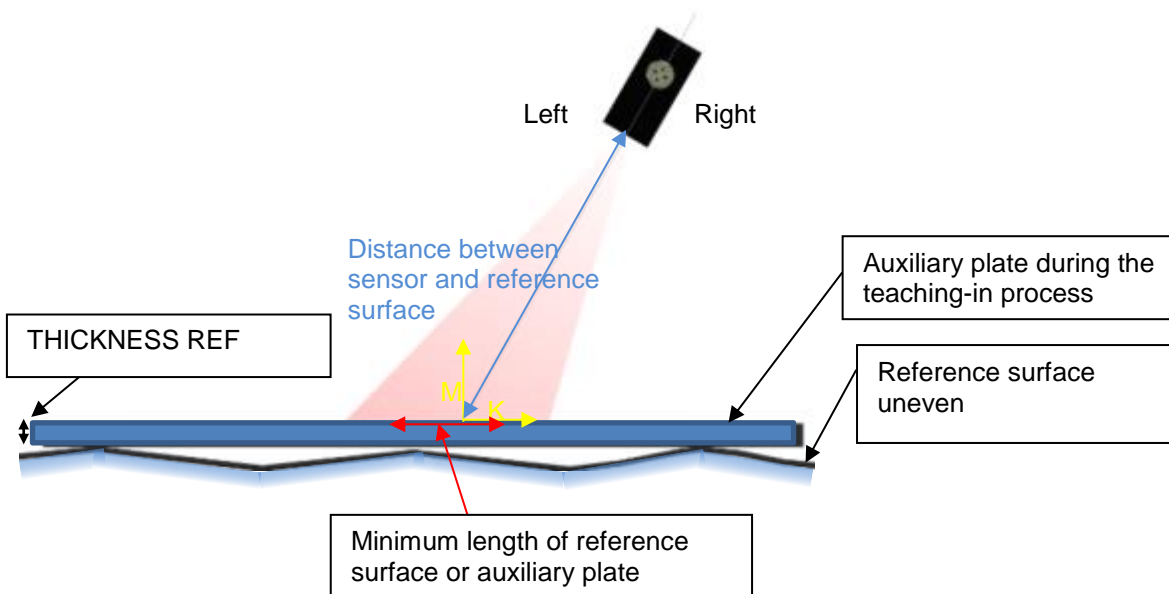

NOTE





The following menu items TEACH REF and THICKNESS REF must be completed so that FLEX MOUNT can be activated.

5.8.3 TEACH REF

Conditions during TEACH REF

The following four conditions must be met during the reference surface teaching-in process. If one of the symbols listed below appears on the display, it lights up red. The teaching-in process can only begin after elimination of all errors (the display no longer lights up red).



Symbol	Error description	Error correction
	Distance between sensor and reference surface not correct. The distance must be observed in accordance with the sensor data sheet, Section 6.1.	Correct distance between sensor and reference surface
	The inclination angle of the sensor to the reference surface is too large. Maximum inclination angle $\pm 30^\circ$	Correct inclination of the sensor
	The reference surface is too uneven. The unevenness must not exceed ± 0.5 mm	Use an auxiliary plate during teach process
	The length of the reference surface is too small. It must conform to the "minimum reference surface length".	Remove objects from the measuring field or use an auxiliary plate during the teaching process

Start the TEACH REF teaching-in process by pressing SET for 2 seconds.

To ensure correct teaching-in of the reference surface, REF THICKNESS must always be completed after the angle teaching-in process. Only in this manner can the effective reference surface be determined with due regard to the thickness of the auxiliary plate.

5.8.4 THICKNESS REF

In this menu item, the reference surface is finally defined with due regard to the thickness of the auxiliary plate.

Important: The sensor automatically suppresses everything below the defined reference surface. This reference surface displacement will also be used to suppress unwanted backgrounds.

The surface taught in under TEACH REF is always the basis for this. This can be corrected downward with a positive value.

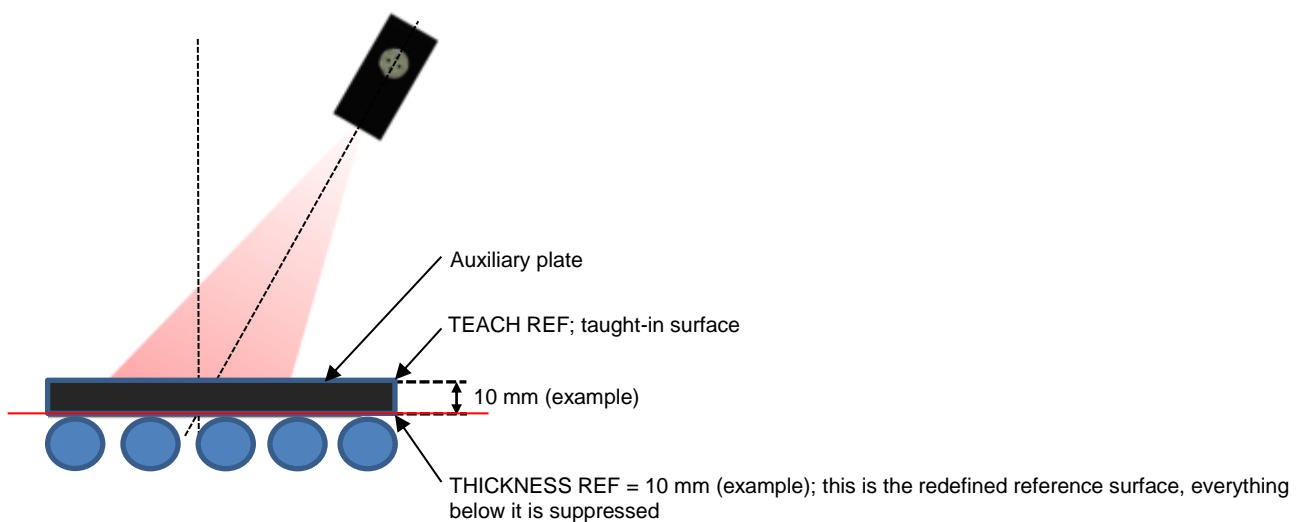

NOTE



If an auxiliary plate is not used, the item THICKNESS REF must be saved with 0 mm by pressing SET for 2 seconds.

NOTE



When FLEX MOUNT is activated, the measuring field and the digital switching output are reset to the standard setting (FLEX MOUNT = Maximum measuring field, DIGITAL OUT = 0 mm).

5.9 MEASURING FIELD

The measuring field can be changed using the "MEASURING FIELD" function. This is particularly useful when e.g. an edge or an undesired object is in the measuring field which should not be detected, or when the sensor is in an angled state and the measuring field should be limited (secured measuring field as a rectangle).

The measuring field is adapted by software so the width of the visible laser beam does not change. When the edge is outside the defined measuring field, the red LED lights up and the alarm output is activated.

5.9.1 AUTO

With this function the measuring field can be limited to a rectangle. This function is particularly useful in the inclined state because the borders of the measuring field can be more easily recognized thanks to the rectangle (secured measuring field in height and width).

The maximum width is automatically calculated by entering the height; the rectangle (height and width) shown on the display is saved by pressing SET for 2 seconds.

When the rectangular measuring field is activated, a square symbol appears on the left side of the screen.



Entering height H in mm: The width of the rectangle is automatically set to the maximum allowable value within the measuring field.

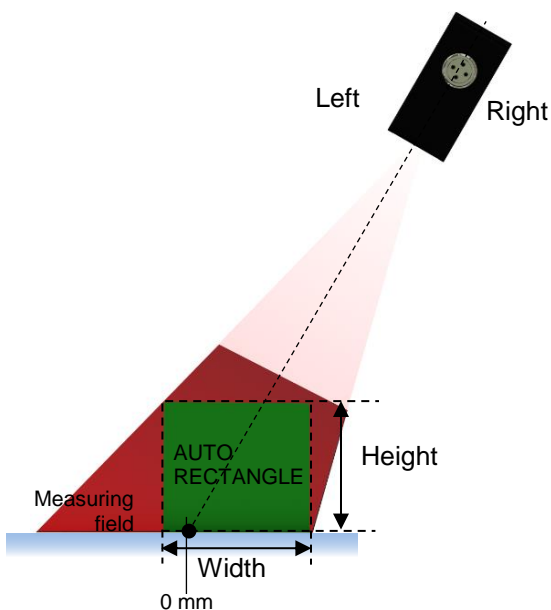

NOTE



The functions LIMIT L, LIMIT R, and OFFSET functions can be used as an aid in the MEASURING FIELD menu to determine the position of the defined rectangle within the measuring field. The values of this rectangle are shown here.

NOTE



When AUTO is used, previously set measuring field limits (left, right and offset) are canceled (e.g. offset is set to 0).

The maximum height and width of the rectangle vary depending on the inclination angle.

Examples with an inclination angle of -30°

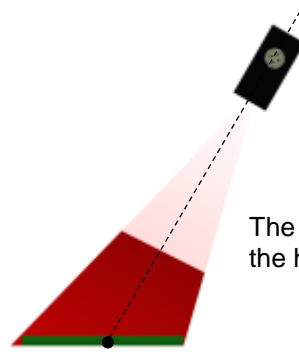
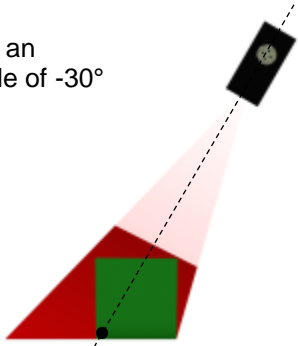

The width increases when the height is reduced

Examples with an inclination angle of -15°

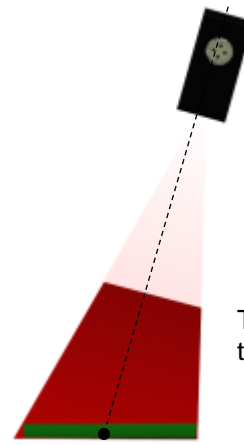
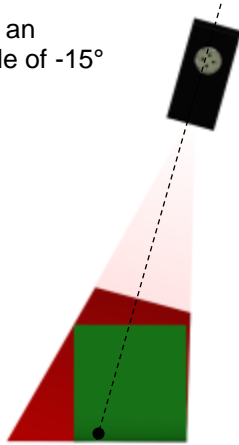

The width increases when the height is reduced

5.9.2 Manual limitation of the measuring field

For full flexibility, every value can also be individually adjusted in the measuring field.

- LIMIT L
- LIMIT R
- OFFSET

Standard installation

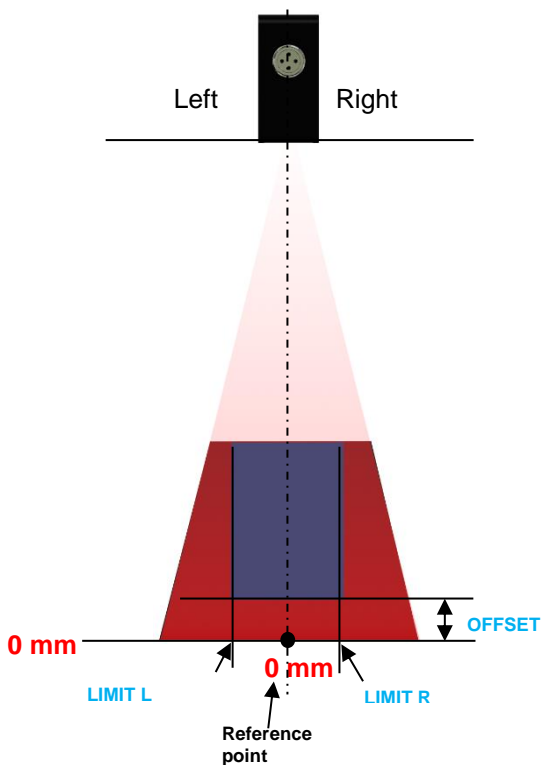

In standard installation (when FLEX MOUNT is not activated), "end of measuring range Sde" is 0.

Angled installation (FLEX MOUNT)

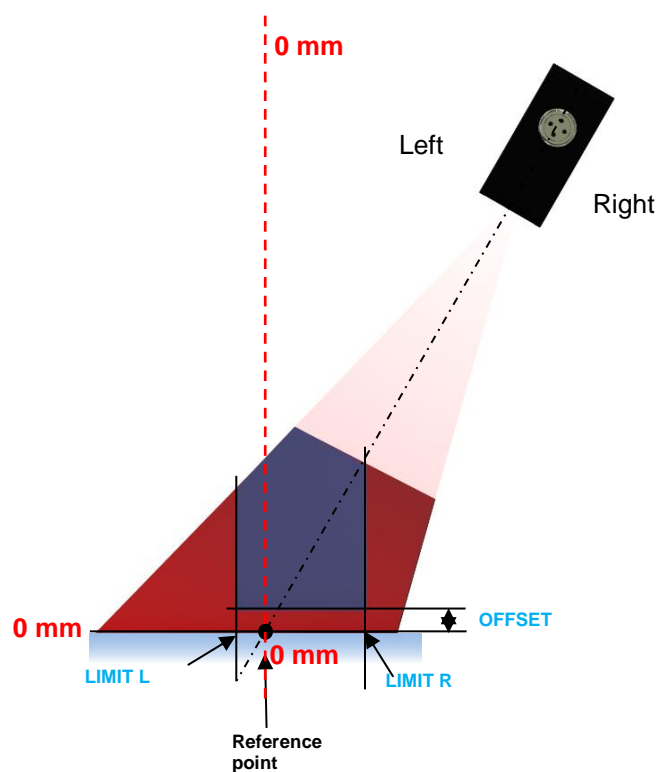

If a reference surface was taught in with FLEX MOUNT, the taught-in surface there is 0.

NOTE



If the measuring field is already limited with a rectangle (AUTO), the rectangle can also be changed with LIMIT L, LIMIT R, and OFFSET.

5.9.3 LIMIT L

Value measured horizontally from reference point (0 mm), to the left.
All edges to the left of this range are suppressed.

5.9.4 LIMIT R

Value measured horizontally from reference point (0 mm), to the right.
All edges to the right of this range are suppressed.

5.9.5 OFFSET

All edges below this line are suppressed.

In standard installation, the offset is measured, (when FLEX MOUNT is not activated) from the sensor reference point (at a distance of 250 mm from the sensor).

If FLEX MOUNT is activated, the taught-in reference surface is zero.

FLEX MOUNT activated

If the FLEX MOUNT function is activated, the sensor already knows the reference surface; the desired offset value can be entered directly.

Example

The offset should be 10 mm above the taught-in reference surface.

Displayed value in the OFFSET menu: 0 mm.

→ Entered OFFSET = 10 mm

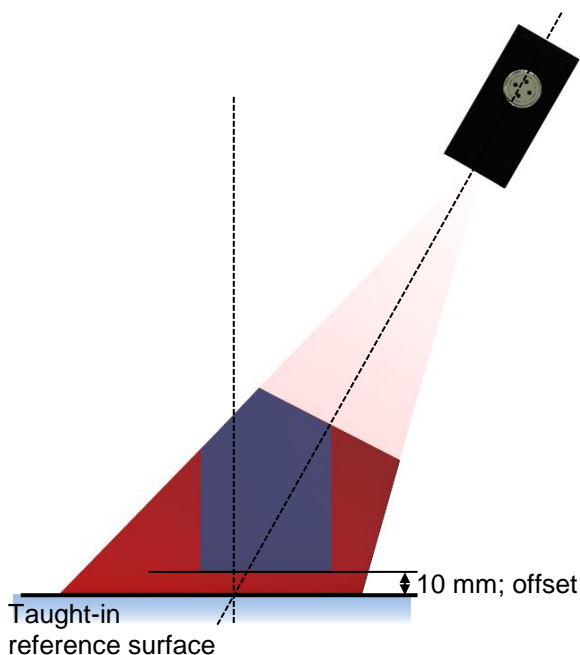

Standard installation

In standard installation, the distance between the reference point and the "end of measuring range Sde" is always 250 mm. The distance from the reference surface can be output with LIVE MONITOR, which makes it easier to calculate the offset.

Example

The offset should be 10 mm above the reference surface.

Displayed value in LIVE MONITOR: 240 mm.

$250 \text{ mm} - 240 \text{ mm} + 10 \text{ mm} = 20 \text{ mm}$

→ Entered OFFSET = 20 mm

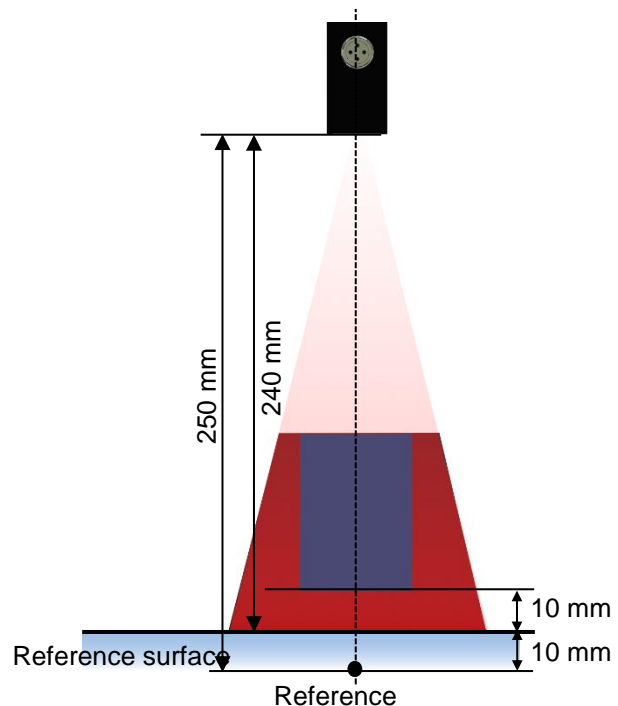

Examples of measuring field limitations:

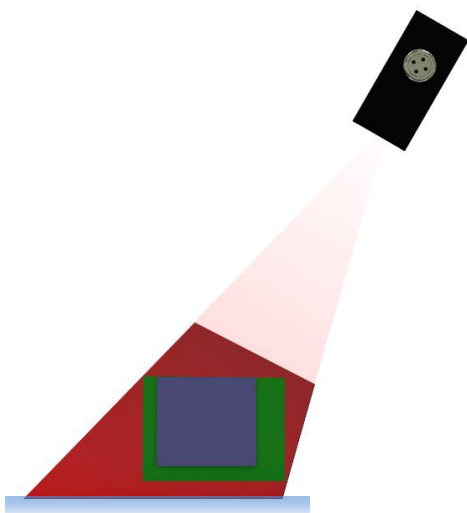
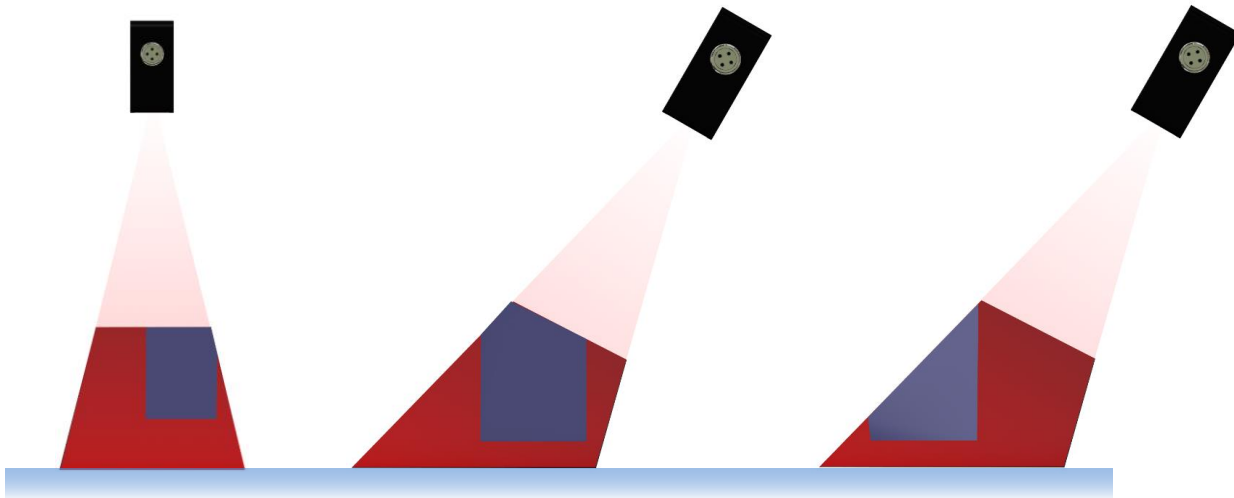

Example with a limited measuring field with AUTO mode (green) and additional limitation LIMIT (blue)

5.9.6 MEASURING FIELD

"Set maximum values" resets all adjustments of the measuring field to the standard settings (see red surface above).

5.10 DIGITAL OUT

With Pin 4 (out), the user has a configurable switching output.

It can be defined as a single switching point (threshold) or a window. Pin 4 is activated when the value (point or window) is exceeded or not reached (active high or active low depending on the setting). The hysteresis for a reliable switching signal is 0.5 mm.

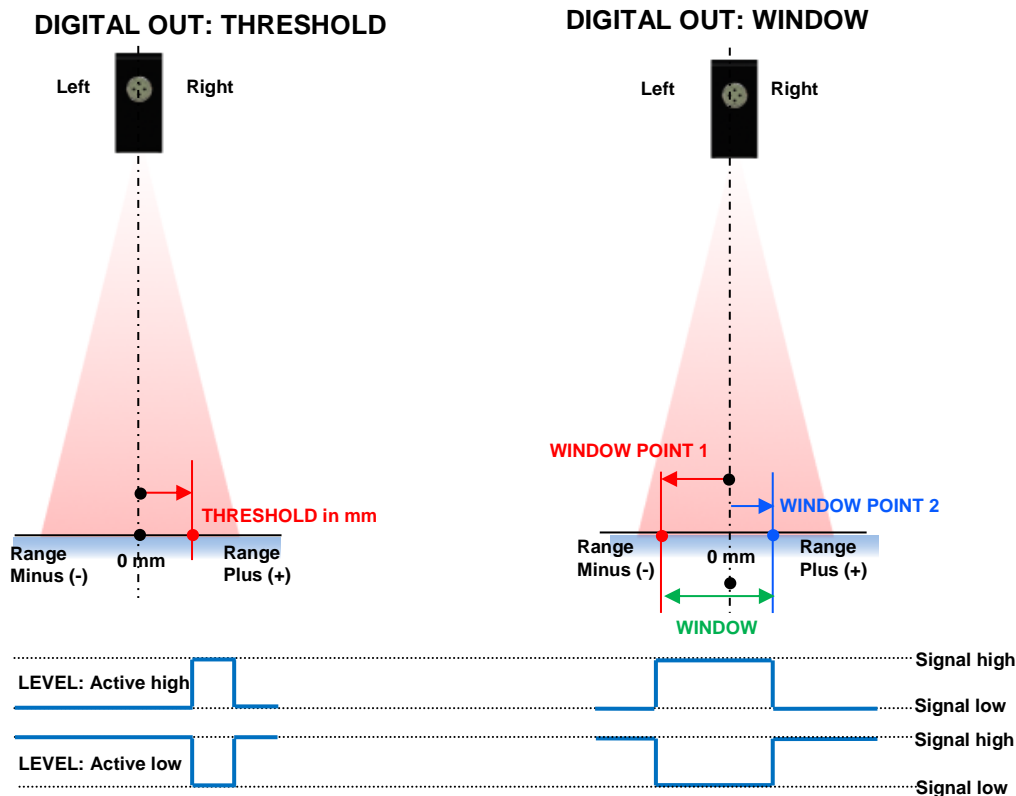

5.10.1 DIGITAL OUT

Whether Pin 4 is to be operated as a **threshold** (with a switch point) or as a **window** (window function) is defined here.

5.10.2 SWITCH POINT

The switch point is selected in mm using the arrow keys. The point must be within the measuring range.

5.10.3 WINDOW P1

Window point 1 (for the WINDOW mode) is selected in mm using the arrow keys. The point must be within the measuring range. The window must be > 2 mm.

5.10.4 WINDOW P2

Window point 2 (for the WINDOW mode) is selected in mm using the arrow keys. The point must be within the measuring range. The window must be > 2 mm.

5.10.5 LEVEL

The output can be set to **Active High** or **Active Low** (inverted) here.

5.11 SYSTEM

5.11.1 RS485 BAUD

The sensor can be operated with three different baud rates:

- 38400
- 57600
- 115200

5.11.2 RS485 ADR

In every PosCon OXE7 sensor, this address is preset to 1 and can be changed in 3 digits. Two sensors in the same network must not have the same number, to prevent the occurrence of bus conflicts. No more than 16 sensors may be connected to one bus.

5.11.3 DISPLAY LIGHT

The display background illumination automatically switches off after the set time or remains switched on. The countdown begins as soon as the keys for an operation are locked (key symbol).

- OFF after 5 min.
- OFF after 10min.
- OFF after 20min.
- Always ON

5.11.4 SENSOR INFO

The sensor type and serial number are displayed here to enable clear identification of the sensor.

- SENSOR TYPE
- SERIAL NUMBER

5.11.5 LANGUAGE

Language selection:

- English
- Deutsch
- Italiano
- Français

5.11.6 RESET

This resets all settings in sensor parameters to the factory settings.

MEASUREMENT TYPE	= Edge L rise
OBJECT HEIGHT	= > 4 mm
OBJECT	= Light
PRECISION	= Standard
FLEX MOUNT	= Not activated (standard installation A = 0°, D = End of measuring range Sde)
MEASURING FIELD	= Max. values (trapezium)
DIGITAL OUT	= Threshold (0 mm, Active high)
RS 485 BAUD	= 57600
RS 485 ADR	= 1
DISPLAY LIGHT	= OFF after 5min.
LANGUAGE	= English

5.12 SETTING

The settings entered in the sensor can be applied, stored or displayed here.

5.12.1 APPLY

The settings saved under SAVE can be activated here.

- Setting 1
- Setting 2
- Setting 3

5.12.2 SAVE

The settings entered in the sensor can be stored here.

Three storage spaces are available.

- Setting 1
- Setting 2
- Setting 3

5.12.3 SHOW

SHOW displays the setting values.

SHOW ACTIVE

Displays the active settings.

SHOW SETTING 1-3

Displays the settings stored in storage spaces 1-3

The values are displayed successively; it is possible to jump to the next value using SET.



FUNCTION
MEASUREMENT TYPE
EDGE HEIGHT / OBJECT HEIGHT / GAP DEPTH
OBJECT
PRECISION
FLEX MOUNT
LIMIT L
LIMIT R
OFFSET
DIGITAL OUT
WINDOW P1
(WINDOW P2)
LEVEL
RS485 BAUD
RS485 ADR

6 Function and definition

6.1 Data sheet

General data	PosCon OXE7 11111452 OXE7.E25T-11111452	PosCon OXE7 11174280 OXE7.E25T-11174280	PosCon OXE7 11148276 OXE7.E25T-11148276	PosCon OXE7 11177353 OXE7.E25T-11177353
Function	Edge position, center, width, gap	Edge position, center, width, gap. For very dark objects such as tire rubber	Edge position, center, width, gap. For very precise measurements	Edge position, center, width, gap. For very precise measurements, for very dark objects
Version	PosCon OXE7	PosCon OXE7	PosCon OXE7	PosCon OXE7
Function: FLEX MOUNT	Yes	Yes	Yes	Yes
Function: MEASURING FIELD	Yes	Yes	Yes	Yes
Measuring range (distance)	150...250 mm	150...250 mm	100...150 mm	100...150 mm
Start of measuring range Sdc	150	150	100	100
End of measuring range Sde	250	250	150	150
Measuring range (width)	75...125 mm	75...125 mm	48...72 mm	48...72 mm
Field of view width right Sdr @ Sde	62.5 mm	62.5 mm	36 mm	36 mm
Field of view width left Sdl @ Sde	-62.5 mm	-62.5 mm	-36 mm	-36 mm
Blind region	0...150 mm	0...150 mm	0...100 mm	0...100 mm
Measuring frequency	125...500 Hz ¹²	90...250 Hz ¹²	159...625 Hz ¹²	111...370 Hz ¹²
Response time	4...16 ms ¹²³	8...22 ms ¹²³	3.0...12.4 ms ¹²³	8.1...18.0 ms ¹²³
Smallest detectable object width	1.5 mm	1.5 mm	0.7 mm	0.7 mm
Smallest detectable gap	2 mm	2.5 mm	1.5 mm	1.5 mm
Smallest detectable step	2 mm	2 mm	0.7 mm	0.7 mm
Resolution	Sdc ... Sde 30 ... 50 µm ¹³	Sdc ... Sde 30 ... 50 µm ¹³	Sdc ... Sde 20 µm ¹³	Sdc ... Sde 20 µm ¹³
Repeat accuracy	Sdc ... Sde 10 µm ¹³	Sdc ... Sde 10 µm ¹³	Sdc ... Sde 10 µm ¹³	Sdc ... Sde 10 µm ¹³
Linearity error	± 80 ... ± 120 µm ¹⁴ ± 160 ... ± 240 µm ¹⁵	± 80 ... ± 120 µm ¹⁴ ± 160 ... ± 240 µm ¹⁵	± 50 ... ± 75 µm ¹⁴ ± 100 ... ± 100 µm ¹⁵	± 50 ... ± 75 µm ¹⁴ ± 100 ... ± 100 µm ¹⁵
Digital output hysteresis	0.5 mm	0.5 mm	0.2 mm	0.2 mm
PRECISION filter values: Standard	Median Off Average Off	Median Off Average Off	Median Off Average Off	Median Off Average Off

¹ Measured with standardized Baumer measuring equipment and objects. Measurement at 90% reflectivity (white)

² Depending on the size of the measuring field and OBJECT light/dark mode

³ Without filter, without averaging

⁴ Measured symmetrically around the reference point with 50% of the measuring field

⁵ Measurement with reduced (90%) measuring range (width)

High	7	16	7	16	7	16	7	16
Very high	15	128	15	128	15	128	15	128
Power on indication	Green LED		Green LED		Green LED		Green LED	
Output indicator	Yellow LED / red LED		Yellow LED / red LED		Yellow LED / red LED		Yellow LED / red LED	
FLEX MOUNT Distance between sensor and reference surface	180...250 mm		180...250 mm		115...150 mm		115...150 mm	
Max. reference surface unevenness	1 mm		1 mm		0.5 mm		0.5 mm	
Min. reference surface length	50 mm		50 mm		24 mm		24 mm	
Max. cable length	5 m up to the neutral point		5 m up to the neutral point		5 m up to the neutral point		5 m up to the neutral point	
Setting	Touch display, RS485		Touch display, RS485		Touch display, RS485		Touch display, RS485	
Heating period	15 min		15 min		15 min		15 min	
Temperature drift	< 0.05% measuring value/K		< 0.05% measuring value/K		< 0.03% measuring value/K		< 0.03% measuring value/K	
Analog output scaling:								
Voltage output	0.05 V/mm		0.05 V/mm		0.1 V/mm		0.1 V/mm	
Current output	0.1 mA/mm		0.1 mA/mm		0.16 mA/mm		0.16 mA/mm	

Electrical data	PosCon OXE7 11111452 OXE7.E25T-11111452	PosCon OXE7 11174280 OXE7.E25T-11174280	PosCon OXE7 11148276 OXE7.E25T-11148276	PosCon OXE7 11177353 OXE7.E25T-11177353
Voltage supply range +Vs	15 ... 28 VDC	15 ... 28 VDC	15 ... 28 VDC	15 ... 28 VDC
Max. supply current (without load)	150 mA	150 mA	150 mA	150 mA
Output circuit	Analog and RS485	Analog and RS485	Analog and RS485	Analog and RS485
Output signal	4 ... 20 mA / 0 ... 10 VDC ¹	4 ... 20 mA / 0 ... 10 VDC ¹	4 ... 20 mA / 0 ... 10 VDC ¹	4 ... 20 mA / 0 ... 10 VDC ¹
Switching output	Push-pull	Push-pull	Push-pull	Push-pull
Switching function	Out 1 / alarm	Out 1 / alarm	Out 1 / alarm	Out 1 / alarm
Output current	< 100 mA	< 100 mA	< 100 mA	< 100 mA
Baud rate	115200, adjustable	115200, adjustable	115200, adjustable	115200, adjustable
Reverse polarity protection	Yes, Vs to GND	Yes, Vs to GND	Yes, Vs to GND	Yes, Vs to GND
Short circuit protection	Yes	Yes	Yes	Yes

¹ FLEX MOUNT activated, inclined 30° and max. measuring field

Mechanical data	PosCon OXE7 11111452 OXE7.E25T-11111452	PosCon OXE7 11174280 OXE7.E25T-11174280	PosCon OXE7 11148276 OXE7.E25T-11148276	PosCon OXE7 11177353 OXE7.E25T-11177353
Width / Height / Length	26 / 74 / 55 mm	26 / 74 / 55 mm	26 / 74 / 55 mm	26 / 74 / 55 mm
Design	Rectangular, front view	Rectangular, front view	Rectangular, front view	Rectangular, front view
Housing material	Aluminum	Aluminum	Aluminum	Aluminum
Front optic	Glass	Glass	Glass	Glass
Connection method	Plug M12 8-pole	Plug M12 8-pole	Plug M12 8-pole	Plug M12 8-pole
Weight	130 g	130 g	130 g	130 g
Ambient conditions	PosCon OXE7 11111452 OXE7.E25T-11111452	PosCon OXE7 11174280 OXE7.E25T-11174280	PosCon OXE7 11148276 OXE7.E25T-11148276	PosCon OXE7 11177353 OXE7.E25T-11177353
Ambient light immunity	< 25 kLux	< 35 kLux	< 35 kLux	< 35 kLux
Operating temperature	-20 ... +50 °C	-20 ... +50 °C	-20 ... +50 °C	-20 ... +50 °C
Storage temperature	-25...+75 °C	-25...+75 °C	-25...+75 °C	-25...+75 °C
Protection class	IP 67	IP 67	IP 67	IP 67
Vibration resistance (sinusoidal)	IEC 60068-2-6:2008 7.5mm p-p for f = 2 - 8Hz 2g for f = 8 – 200Hz, or 4g for 200 – 500Hz	IEC 60068-2-6:2008 7.5mm p-p for f = 2 - 8Hz 2g for f = 8 – 200Hz, or 4g for 200 – 500Hz	IEC 60068-2-6:2008 7.5mm p-p for f = 2 - 8Hz 2g for f = 8 – 200Hz, or 4g for 200 – 500Hz	IEC 60068-2-6:2008 7.5mm p-p for f = 2 - 8Hz 2g for f = 8 – 200Hz, or 4g for 200 – 500Hz
Resonance test	IEC 60068-2-6:2008 1.5mm p-p for f = 10 - 57Hz , 10 cycles for each axis 10g for f = 58 -2,000Hz, 10 cycles for each axis	IEC 60068-2-6:2008 1.5mm p-p for f = 10 - 57Hz , 10 cycles for each axis 10g for f = 58 -2,000Hz, 10 cycles for each axis	IEC 60068-2-6:2008 1.5mm p-p for f = 10 - 57Hz , 10 cycles for each axis 10g for f = 58 -2,000Hz, 10 cycles for each axis	IEC 60068-2-6:2008 1.5mm p-p for f = 10 - 57Hz , 10 cycles for each axis 10g for f = 58 -2,000Hz, 10 cycles for each axis
Vibration resistance (random)	IEC 60068-2-64:2008 Spectrum: 0.1 g2/Hz for 20 – 1,000Hz, 30 minutes / axis (>10gRMS)	IEC 60068-2-64:2008 Spectrum: 0.1 g2/Hz for 20 – 1,000Hz, 30 minutes / axis (>10gRMS)	IEC 60068-2-64:2008 Spectrum: 0.1 g2/Hz for 20 – 1,000Hz, 30 minutes / axis (>10gRMS)	IEC 60068-2-64:2008 Spectrum: 0.1 g2/Hz for 20 – 1,000Hz, 30 minutes / axis (>10gRMS)
Shock resistance	IEC 60068-2-27:2009 50g / 11ms or 100g / 6ms, 10 shocks in each axis and each direction 100g / 2ms, 5,000 shocks in each axis and each direction	IEC 60068-2-27:2009 50g / 11ms or 100g / 6ms, 10 shocks in each axis and each direction 100g / 2ms, 5,000 shocks in each axis and each direction	IEC 60068-2-27:2009 50g / 11ms or 100g / 6ms, 10 shocks in each axis and each direction 100g / 2ms, 5,000 shocks in each axis and each direction	IEC 60068-2-27:2009 50g / 11ms or 100g / 6ms, 10 shocks in each axis and each direction 100g / 2ms, 5,000 shocks in each axis and each direction
Impact resistance	IEC 60068-2-27 100g / 2ms, 4,000 shocks in each axis and each direction	IEC 60068-2-27 100g / 2ms, 4,000 shocks in each axis and each direction	IEC 60068-2-27 100g / 2ms, 4,000 shocks in each axis and each direction	IEC 60068-2-27 100g / 2ms, 4,000 shocks in each axis and each direction

Optical properties	PosCon OXE7 11111452 OXE7.E25T-11111452	PosCon OXE7 11174280 OXE7.E25T-11174280	PosCon OXE7 11148276 OXE7.E25T-11148276	PosCon OXE7 11177353 OXE7.E25T-11177353
Light source	AlGaInP laser diode	AlGaInP laser diode	AlGaInP laser diode	AlGaInP laser diode
Wave length	656 nm	660 nm	660 nm	660 nm
Operating Mode	pulsed	pulsed	pulsed	pulsed
Pulse duration				
Light mode	1 ms	3 ms	0.1 ms	1.2 ms
Dark mode	3 ms	6 ms	0.3 ms	3.6 ms
Pulse period				
Light mode	2...7 ms	4...8 ms	1.6...5.9 ms	2.7...6.6 ms
Dark mode	4...8 ms	7...11 ms	1.8...6.3 ms	5.2...9.0 ms
Total emitted pulse power	3 mW	15 mW	15 mW	15 mW
Beam shape	Elliptical (focused toward laser line)	Elliptical (focused toward laser line)	Elliptical (focused toward laser line)	Elliptical (focused toward laser line)
Focal distance d_f	200 mm	200 mm	125	125 mm
Beam size at window				
Vertical δ_{\perp}	3 mm	3 mm	2.5 mm	2.5 mm
Parallel	8 mm	8 mm	7.5 mm	7.5 mm
Beam size at focal point				
Vertical	< 0.5 mm	< 0.5 mm	< 0,1 mm	< 0,1 mm
Parallel	L = 120 mm	L = 120 mm	L = 73 mm	L = 73 mm
Beam divergence				
Vertical	10 mrad	10 mrad	16 mrad	16 mrad
Parallel	32°	32°	30.2°	30.2°
Laser classification (per IEC 60825-1/2014)	Laser class 1	Laser class 1	Laser class 1	Laser class 1

6.1.1 Beam divergence

Vertical level:

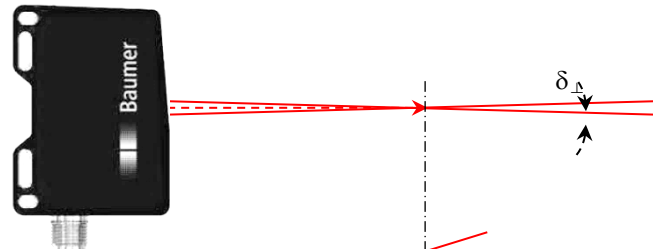

Horizontal level:

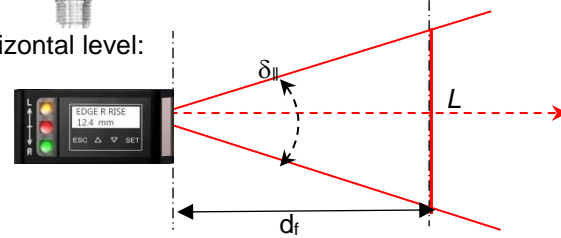

6.2 Dimensions

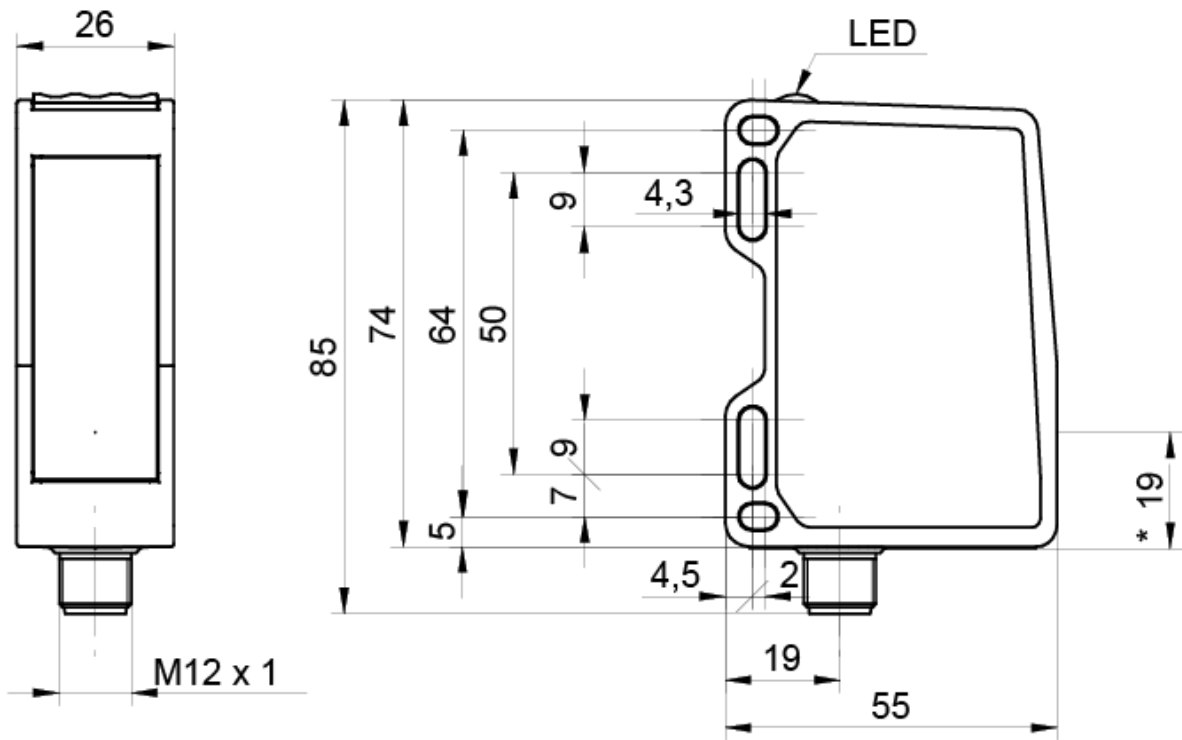

*Optical axis

6.3 Mode of operation



The PosCon OXE7 edge sensor operates based on the laser triangulation principle. By means of special optics, a laser beam is enlarged into a line and projected to the surface of the object to be measured. Using the multi-lens system, the reflected light from this laser line is projected onto a matrix. A controller calculates from this matrix image the precise position e.g. of the beginning or end of an object (i.e. of an edge) along the laser line. Thanks to the new Baumer qFlex technology, the position of the edge is output irrespectively of the distance between the sensor and the object to be measured. The sync input on PosCon OXE7 enables synchronization of measurement data with an object movement.

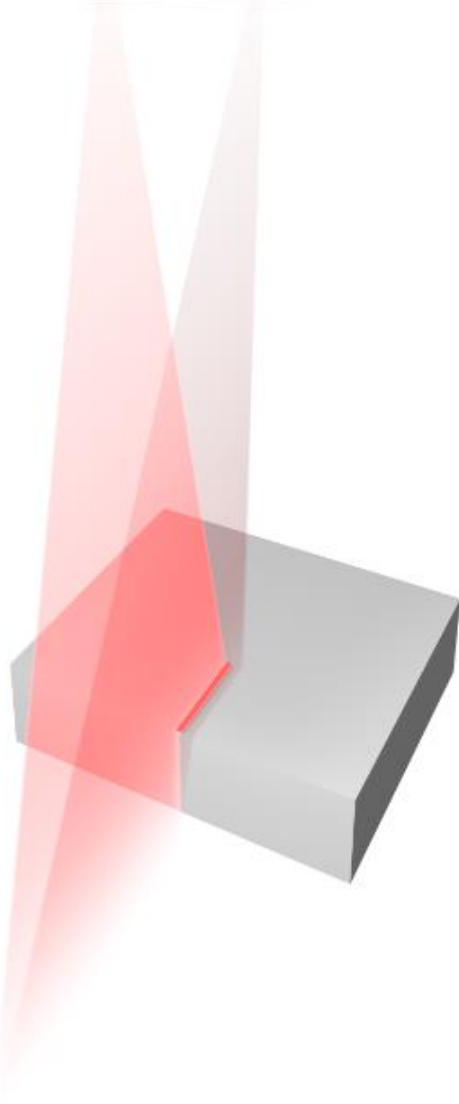

6.3.1 Distance-independent measurement

Thanks to the unique mode of operation, the position of an object in the measuring field is not important when e.g. the width or the gap is measured.

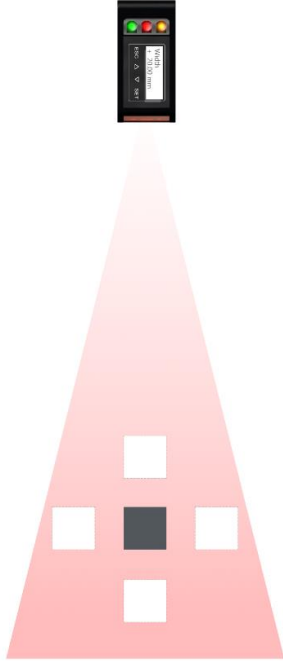

6.3.2 qTarget

Because the measuring field is exactly aligned to the housing reference surfaces at the factory, the beam position in every sensor is exactly in the same spot, which makes planning and sensor replacement very easy.

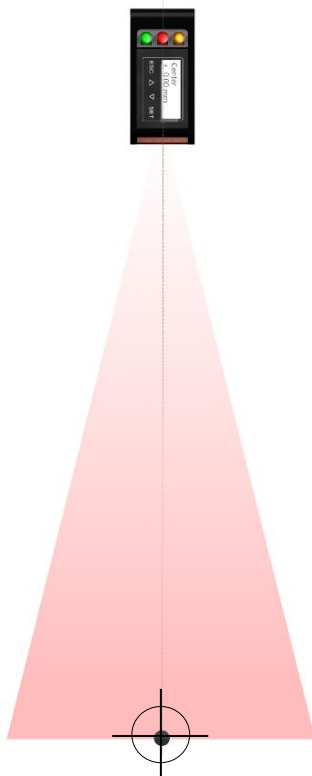

6.4 Object to be measured

6.4.1 Object size

The following requirements must be met so that the sensor can evaluate the object to be detected:
The width of the object to be measured must not be smaller than the "smallest detectable object", and its height (step) must not be smaller than the "smallest detectable step".

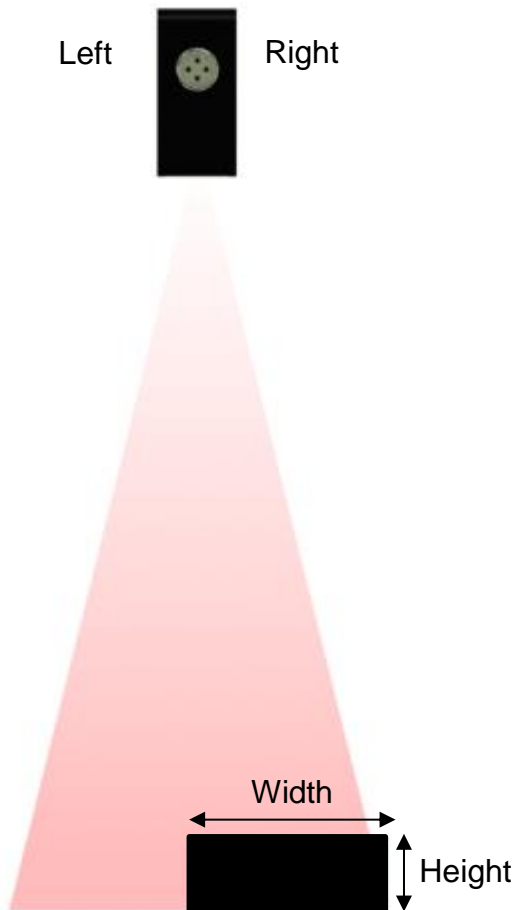

6.4.2 Definition of flanks

The edges to be detected are defined as **rising** or **falling** flanks.

The position/selection of flanks is defined as **first from the left** or **first from the right**.

A **rising flank** is

- a flank which runs from far to near
- a flank which runs from infinity (or nothing) to an object

A **falling flank** is

- a flank which runs from near to far
- a flank which runs from an object to infinity (or nothing)

The point of the flank which is closer to the sensor is **always** chosen as the measuring value. The border of the measuring range is not an edge.

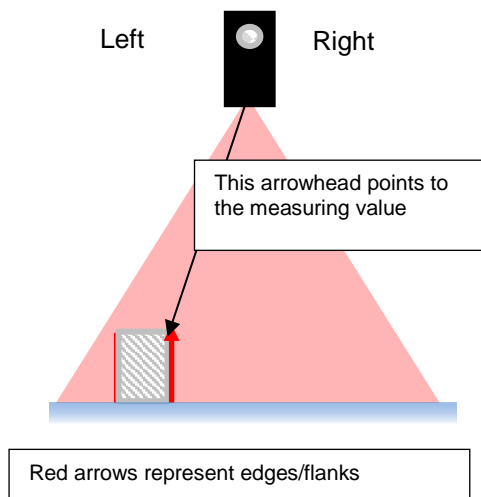

6.4.3 Definition of an edge

Edge

An edge is the transition of a stable level (1) inside or outside the measuring range to another stable level (2). Measurement is always carried out at the level that is closer to the sensor. The detection of an edge is also possible if only one of the levels is within the measuring range. This situation is called edge-to-infinity and can occur, if the second level is too far away from the sensor front or if it is not present at all.

The average increase must be greater than ± 1.5 mm at 0.5 mm.

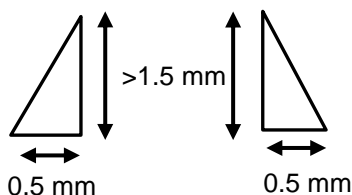

6.5 Interfaces and outputs

All sensor inputs and outputs which transmit measuring data are referred to as interfaces.

- Analog current output, 4 ... 20mA or 0 ... 10V (switching)
- Synchronization
- Switching output push-pull
- Alarm output push-pull
- RS-485

6.5.1 Analog signal output

The sensor is equipped with an adaptive output. This means the sensor detects automatically whether it should supply current or voltage. For this purpose, the load is measured when voltage is connected: If the load is high-impedance ($>10\text{ k}\Omega$), the voltage output is activated, or else the current output.

To change to the other analog mode (mA or volt), the supply voltage +Vs from the sensor must be switched on and off again.

6.5.1.1 Voltage drop

The ICC supply current from the sensor flows via the +24V line to the sensor and on the 0V line back to the power supply unit. This ICC current supply ensures that a U_{RL1} voltage drop occurs according to Ohm's law at the R_{L1} line resistance. This U_{RL1} voltage drop ensures that the U-Out (0...10V) is increased as result. This may be treated like an offset and subtracted from the measurement result. Because the resistances have a constant value, the voltage drop varies only slightly depending on the ICC sensor current.

This effect does not occur if the I-Out (4...20mA) is used instead of the U-Out (0...10V).

Layout:

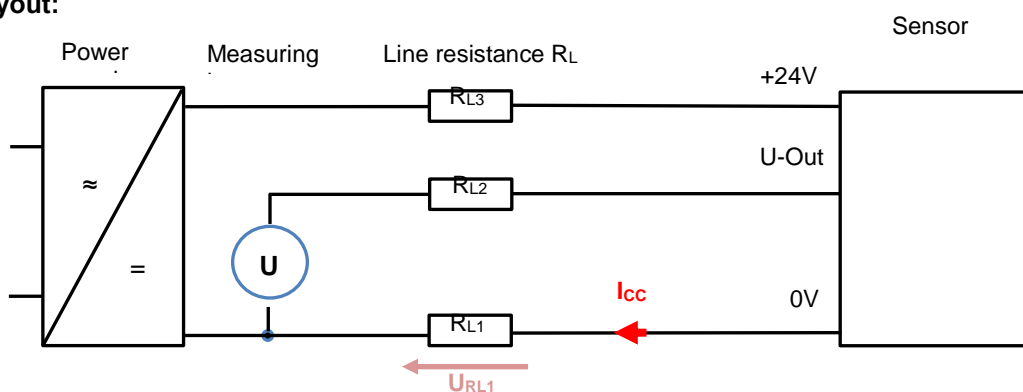

The line resistance varies depending on the line length. In addition, the contact resistances at the plug and the ICC supply current affect the U_{RL1} voltage drop.

Example:

A 10m long line has a resistance of approx. 1Ω . The sensor draws a current of 90mA. According to Ohm's law, the following voltage drop occurs at R_{L1} :

$$U_{RL1} = R_{Line} * I_{CC}$$

$$U_{RL1} = 1\Omega * 90mA = 90mV$$

In this example, the U-Out is increased by 90mV.

Tip:

Many measuring inputs can, however, only be operated with 0...10V. Using a simple trick, 2...10V can, according to Ohm's law, be generated from 4...20mA with a resistance of 500Ω (parallel switching of two R_M resistances of 1000Ω). That way the effect can be avoided.

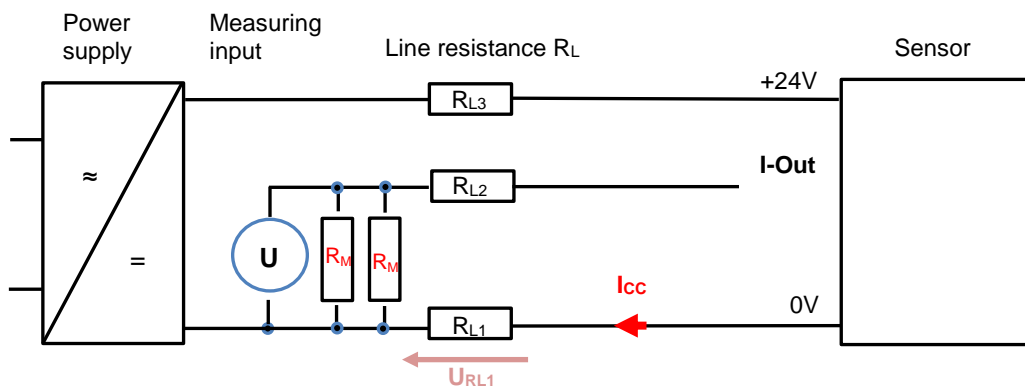

6.5.2 Calculating the analog output signal

The measuring values in mm can be converted into the analog output signal with the following formulas.

6.5.2.1 Sensors with measuring range (Distance) 100...150 mm

Fixed scaling:

- 10 mm/V
- 6.25 mm/mA

Function edge or center

Output signal in mA = 12mA + measuring value in mm * 0.16mA/mm

Output signal in V = 5V + measuring value in mm * 0.1V/mm

Function width or gap width

Output signal in mA = 4mA + measuring value in mm * 0.16mA/mm

Output signal in V = measuring value in mm * 0.1V/mm

6.5.2.2 Sensors with measuring range (Distance) 150...250 mm

Fixed scaling:

- 20 mm/V
- 10 mm/mA

Function edge or center

Output signal in mA = 12 mA + measuring value in mm * 0.1 mA/mm

Output signal in V = 5 V + measuring value in mm * 0.05 V/mm

Function width or gap width

Output signal in mA = 4 mA + measuring value in mm * 0.1 mA/mm

Output signal in V = measuring value in mm * 0.05 V/mm

6.5.3 Sync-In / Trigger

The measurement and signal output can be interrupted with the Sync-In input by connecting with high. As long as Sync-In is on high, the sensor delays the next measurement (hold) and reduces the power of the laser beam.

- The sensor checks Sync-In before every measurement
- The previous measurement cycle is always completed first, even if Sync-In is on high
- During the waiting time (hold), the power of the beam is reduced, and the output signal is 4mA or 0V
- To return the sensor to measuring mode, Sync-In must be set from high to low
- Sync-In must remain on low for at least 5 μ s in order for the sensor to begin measuring again
- If Sync-In switches from high to low level, the response time lasts takes longer in the first measurement cycle

Sync-In	Level	Measurement
Sync-In low	0...2.5 V	Run
Sync-In high	8 V...UB (operating voltage)	Hold

Application example: Reciprocal influence

Only the laser beam of Sensor1 may be in the measuring field of Sensor1. The laser beam of Sensor2 must be outside the measuring field of Sensor1. This situation can happen if the sensors are mounted at an angle to another, but especially when the sensors are facing each other. Such a situation should be avoided through an appropriate installation if possible.

If it is not possible to prevent several sensors from affecting each other through appropriate installation, the sensors can be operated asynchronously using the the Sync-In cable. The superordinate control generates the signals for this.

Measurement in case of Sync-In low:

Every time before a laser pulse is transmitted, the sensor checks the level at Sync-In. If it is low, the sensor immediately begins the next measurement.

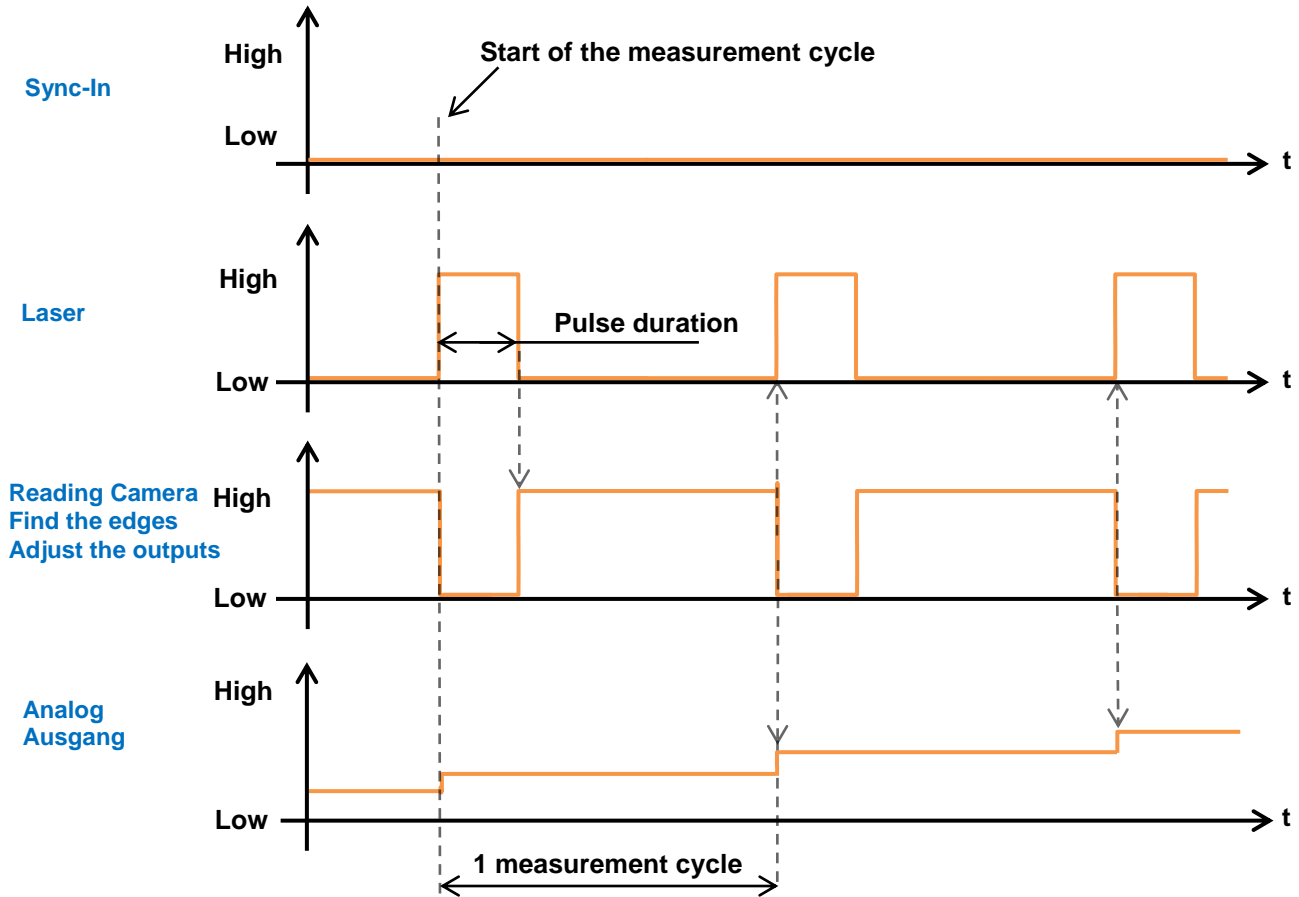

Sync-In low to high:

If the Sync-In level is on high, the sensor always finishes its initiated measurement and then holds off on doing the next measurement. All outputs are held (hold function).

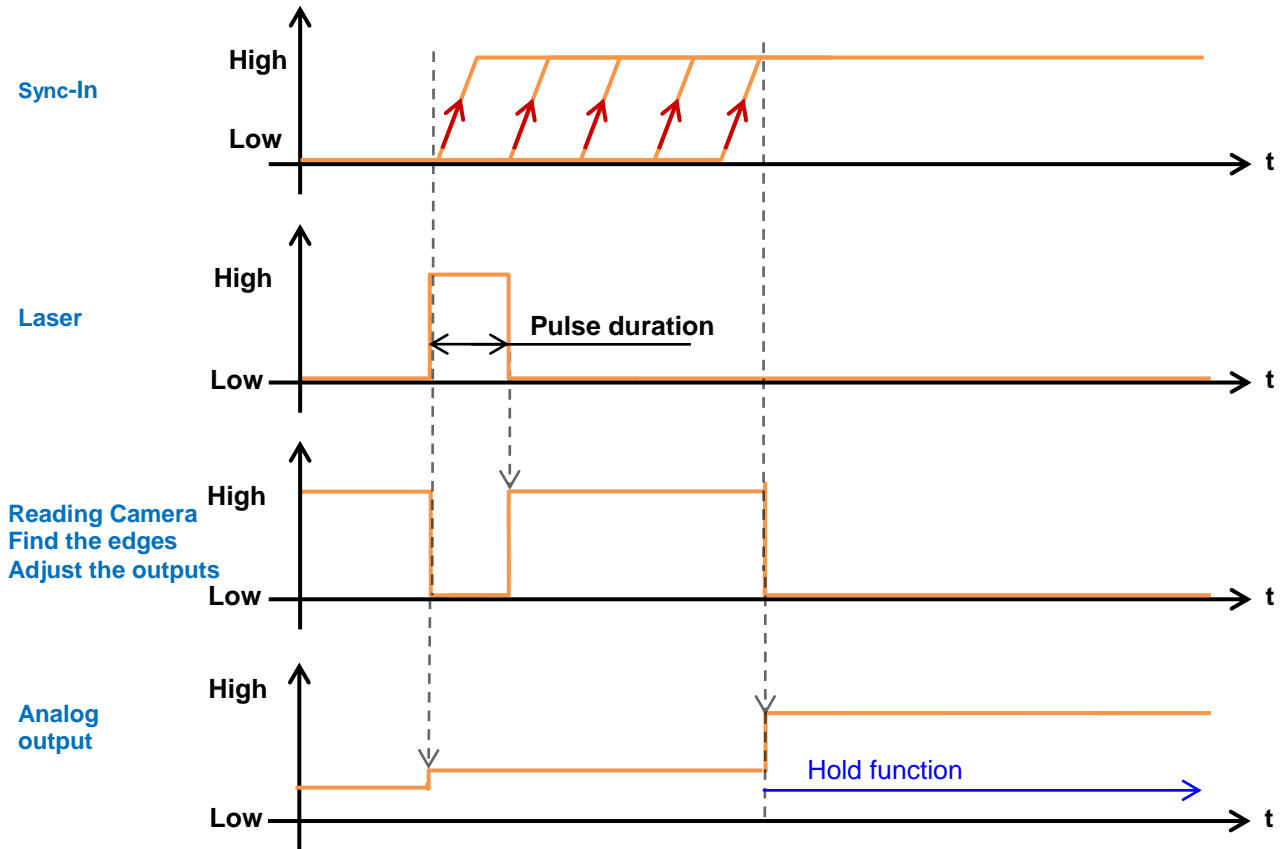

Sync-In high to low:

To return the sensor to measuring mode, Sync-In must be set from high to low. Sync-In must remain on low for at least 5 μs in order for the sensor to begin measuring again.

If Sync-In switches from high to low level, the response time lasts longer in the first measurement cycle.

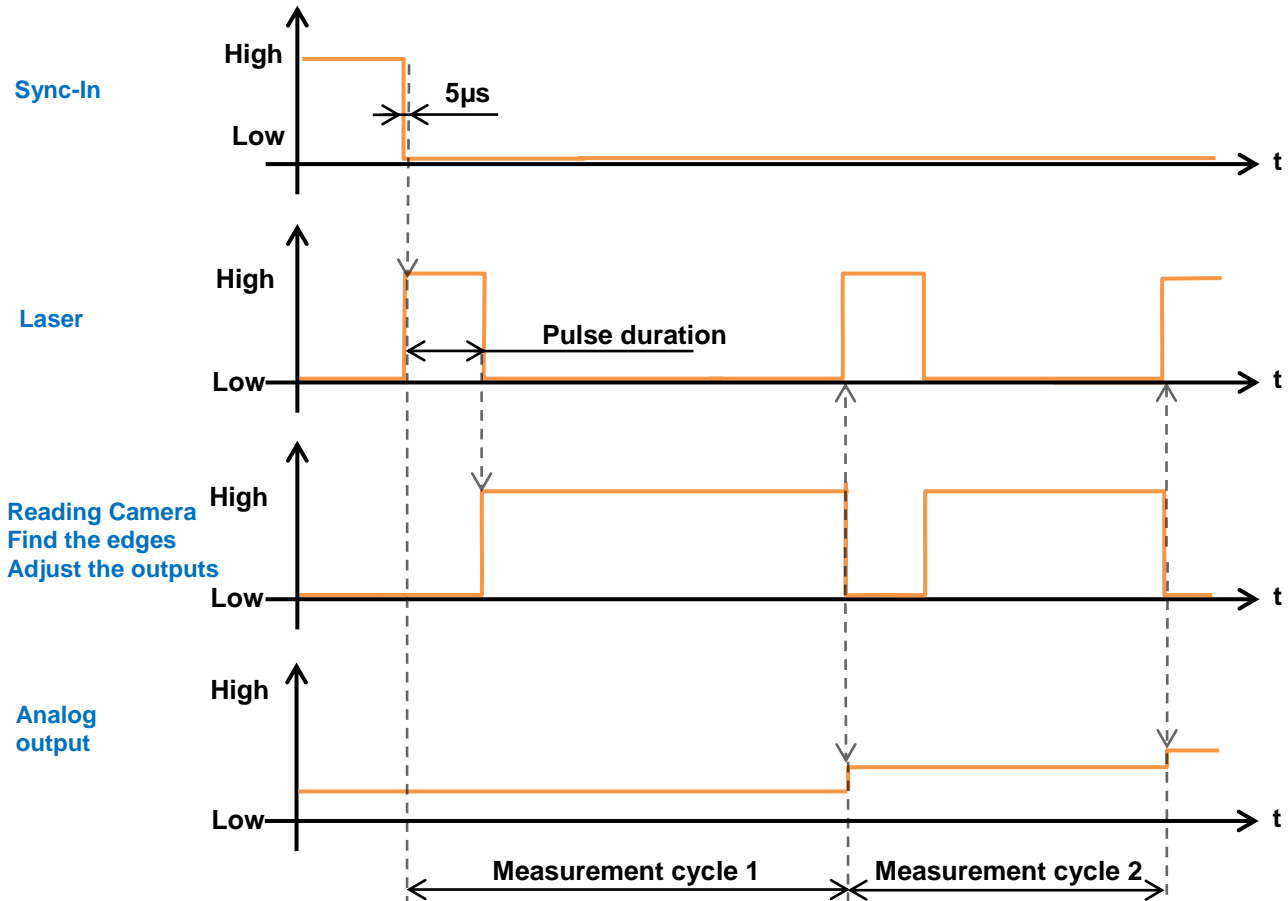

6.5.4 Switching output

The switching output can be adjusted as a point or a window and the switching points can be set, see Section DIGITAL OUT.

The output is transmitted as a push-pull signal with active high or active low, depending on the setting.

6.5.5 Alarm

The alarm output cannot be adjusted and is triggered by the following situations:

- No object in the measuring field
- No edge in the measuring field
- Amplitude of the received signal is insufficient (e.g. in case of soiling)

It is output as a push-pull signal (active high).

6.5.6 Interface RS-485

No more than 16 sensors may be connected to one bus during operation with RS-485.

When the RS485 interface is activated, the analog output, the digital output, and the alarm output are deactivated.

See separate RS 485 manual.

6.6 Touch panel

6.6.1 Function and design

The display consists of a monochrome 128 x 32 Pixel LCD with RGB LED background illumination. The sensor can be configured using four keys.

Operation:

Four capacitive touch operator interfaces.

6.6.2 Dimensioning

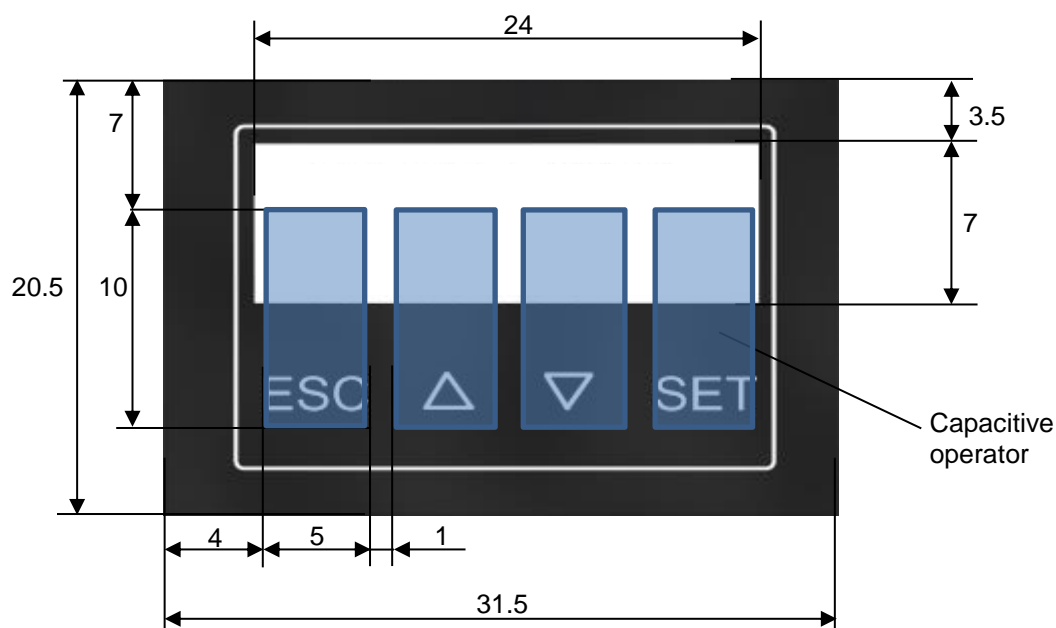

6.7 Memory

All changes made in the sensor are saved in nonvolatile (permanent) memory and are even retained after a power outage.

7 Safety instructions and maintenance

7.1 General safety instructions

Intended use

This product is a precision device and is used for object detection and the preparation and/or provision of measuring values as electrical quantities for a subsequent system. Unless this product is specially labeled, it may not be used for operation in potentially explosive environments.

Commissioning

Installation, mounting and adjustment of this product may be performed only by a qualified person.

Installation



For mounting, use only the mechanical mountings and mechanical mounting accessories intended for this product. Unused outputs must not be wired. In cable versions with unused cores, these cores must be insulated. Always comply with admissible cable bending radii. Prior to electrical connection of the product, the system must be disconnected from the power supply. In areas where shielded cables are mandatory, they must be used as protection against electromagnetic disturbances. If the customer makes plug connections to shielded cables, an EMC version of the connectors should be used, and the shield must be connected to the connector housing across a large area.

Caution

Deviation from the procedures and settings specified here can lead to hazardous radiation effects.

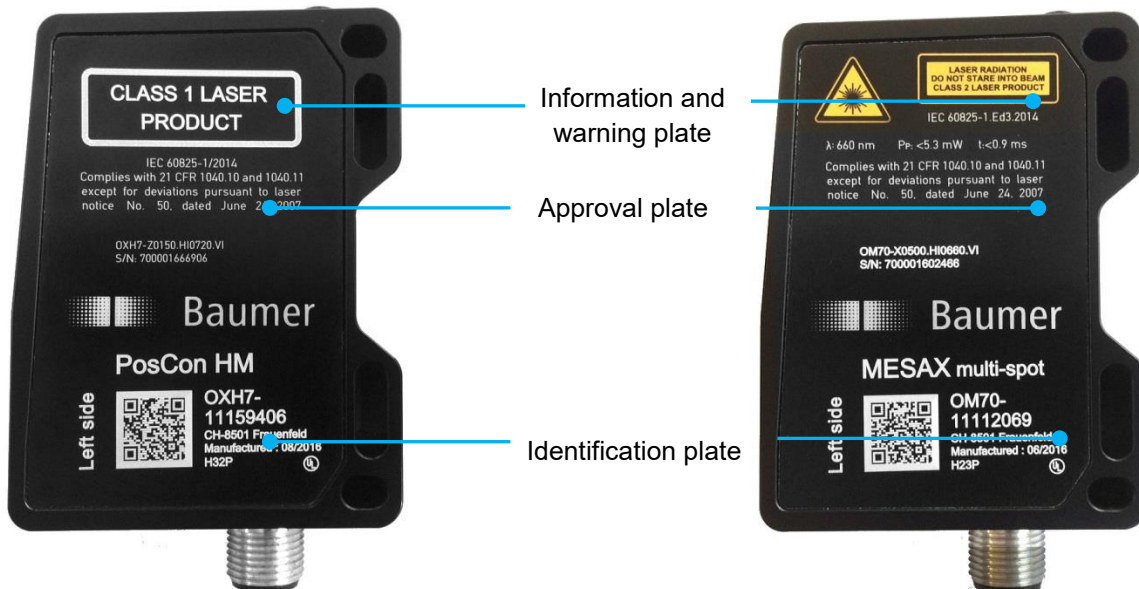
7.2 Sensor inscriptions



Information and warning plate	<p style="text-align: center;">Class 1: No risk for eyes or skin</p> <div style="border: 2px solid black; padding: 10px; text-align: center; margin: 10px auto; width: 80%;"> <p>CLASS 1 LASER PRODUCT</p> </div> <p>Class 1 lasers are safe under reasonably foreseeable operational conditions of normal use, including direct long-term viewing of the beam, even when exposure occurs using a magnifying optic. However, viewing a Class 1 laser product directly can cause iridescent visual effects, particularly if the level of ambient light is low.</p>	<p style="text-align: center;">Class 2: Do not look into the beam</p> <div style="display: flex; align-items: center; justify-content: center; margin: 10px auto;">  <div style="border: 2px solid black; padding: 5px; text-align: center; width: 150px;"> <p style="font-size: 8px; margin: 0;">LASER RADIATION DO NOT STARE INTO BEAM Wavelength: 640...670nm</p> <p style="font-size: 8px; margin: 0;">IEC 60825-1, Ed. 3, 2014 CLASS 2 LASER PRODUCT</p> </div> </div> <p>The accessible beam is in the visible spectral range (400 nm to 700 nm). It is also safe for the eye for short periods of exposure (up to 0.25 s). Accidental short-term exposure (up to 0.25 s) does not damage the eye, because the corneal reflex can automatically protect the eye sufficiently from longer radiation. Class 2 lasers can therefore be used without further protection if it is ensured that it is not necessary to look at it intentionally for longer than 0.25 s, or the corneal reflex is suppressed (e.g. due to the influence of medication).</p>
Approval plate	<p>FDA certification: Complies with 21 CFR 1040.10 and 1040.11 except for conformance with IEC 60825-1 Ed. 3., as described in Laser Notice No. 56, dated May 8, 2019</p>	
Identification plate	<div style="text-align: center; margin-bottom: 10px;">  </div> <p>The sensor identification plate contains the following information:</p> <ul style="list-style-type: none"> • Company logo • Sensor brand name • QR code for additional information • Article name and article number • Product data • Serial number: 	

7.3 Influence of ambient light

Ambient light from lamps, the sun, etc. in the view field of the sensor can lead to malfunctions or a reduction of accuracy and should be avoided as much as possible.

7.4 Mechanical damage

In the event of a broken front optic, defective display, or loose or exposed laser lens, the sensor must be disconnected from the power supply immediately. It must not be put into operation again until it has been repaired by an authorized person. Non-compliance with these safety instructions may lead to the release of hazardous laser beams.

**ATTENTION!**

The use of a sensor with a broken front optic or loose or exposed lens can lead to hazardous laser radiation.

7.5 Cleaning the sensors

The laser distance sensors do not require any maintenance, except that the front windows must be kept clean. Dust and fingerprints can impair sensor function. It is normally sufficient to wipe the windows with a clean (!), soft lens cleaning cloth. Alcohol or soapy water can be used in case of severe soiling. The display and the keys must be kept free from dirt and moisture. Water and dirt on the keys can impair their function.

7.6 Disposal

This sensor contains electronic components. Dispose of parts according to country-specific provisions.

8 Error correction and tips

8.1 Effects of deviations in the inclination angle

Measuring errors occur if the actual inclination angle of the sensor deviates from its stored angle (tilting angle).

When the sensor is mounted at an angle and FLEX MOUNT is inactive, the tilting angle cannot be compensated and measuring errors can occur.

Tilting angle	Measuring error
0°	0.00 %
1°	0.02 %
2°	0.06 %
3°	0.14 %
4°	0.24 %
5°	0.38 %
6°	0.55 %
7°	0.75 %
8°	0.97 %
9°	1.23 %
10°	1.52 %
11°	1.84 %
12°	2.19 %
13°	2.56 %
14°	2.97 %
15°	3.41 %
16°	3.87 %
17°	4.37 %
18°	4.89 %
19°	5.45 %
20°	6.03 %
21°	6.64 %
22°	7.28 %
23°	7.95 %
24°	8.65 %
25°	9.37 %
26°	10.12 %
27°	10.90 %
28°	11.71 %
29°	12.54 %
30°	13.40 %

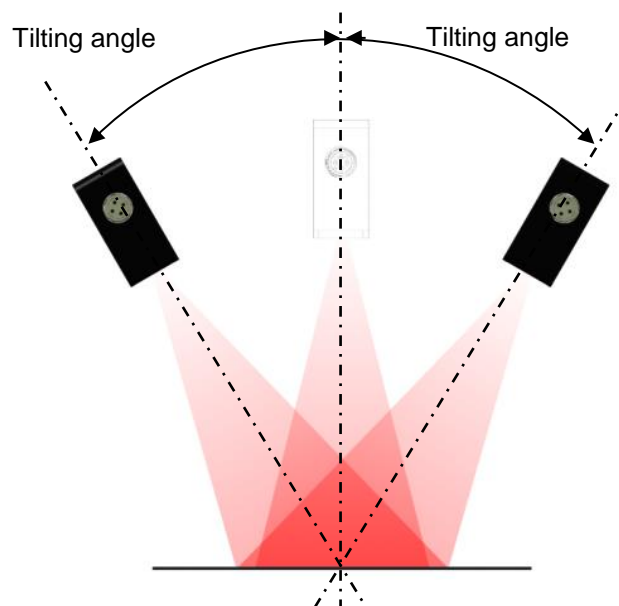

8.2 The dependency of the measuring frequency

Since the measuring frequency is dependent on various factors, the measuring frequency is specified in the data sheet as a range (for example 125 ... 500 Hz).

The following factors have an influence on the measuring frequency:

- Measuring field width
- Measuring field height
- OBJECT setting: Bright or dark

The measuring field height influences the measuring frequency more than the limitation of the measuring field width.

8.2.1 Increasing the measuring frequency

To increase the measuring frequency, the following settings can be made:

Limitation of the measuring field (width)

Limitation of the measuring field with LIMIT LEFT and LIMIT RIGHT as small as possible.

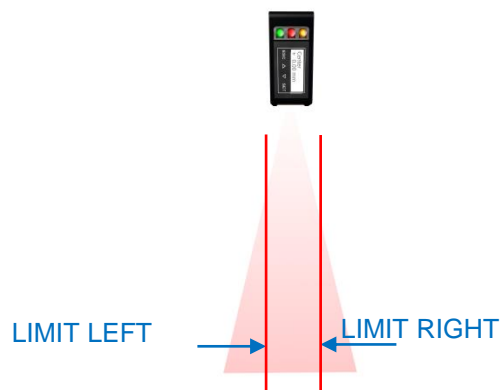

Limitation of the measuring field (height)

Limitation of the measuring field with AUTO H and OFFSET.

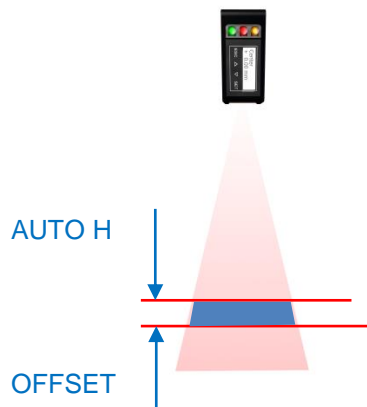

Limited measuring field in max. distance

The position of the limited measuring field should be in max. distance to the sensor.

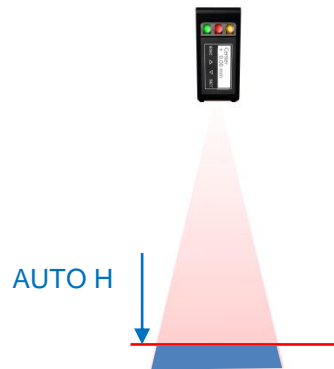
**OBJECT setting**

The OBJECT setting changes the exposure time. For a fast measurement frequency, this setting should be set to "Bright".

8.3 Error correction

Error	Error correction
No function	Check connection. Power supply 15...28 VDC between pin 2 (+Vs) and pin 7 (GND)
Green LED flashes	Short circuit in connecting cable. Check connection.
Red LED lights up	<ul style="list-style-type: none"> Object outside measuring field (near, far or to the side) No edge in the measuring field Amplitude of the received signal is insufficient (e.g. in case of soiling)
Touch panel cannot be operated	<ul style="list-style-type: none"> Touch panel locked. Re-enable panel for operation by sliding a finger over the 4 keys from left to right. RS-485 controls the sensor--> operation via the touch panel not possible at the same time RS-485 locks the touch keys--> the touch panel was locked via RS-485 and can only be re-enabled with a command via RS-485
Touch panel does not react	<ul style="list-style-type: none"> Clean panel. The panel is dirty or wet, which makes it harder to press the keys
Sensor measures inaccurately	<ul style="list-style-type: none"> Check inclination angle and work in FLEX MOUNT mode if required (teach the new reference surface) Adjust edges of the object. The edges of the object do not meet the requirements according to Section "Functions and Definitions / Object to be measured / Definition of an edge" The object is in the blind region (too close to the sensor); the displayed measuring value is a shadow of the object (fictitious edge) Bright object, avoid direct reflexes from the transmitter to the receiver
Measured zero point not in the center of the red laser line	Adjust evaluation. The sensor is mounted at an inclined angle to the reference surface so that the zero point shifts compared to standard installation (right angle). See also Section "Sensor alignment"
The sensor does not measure all objects within the red laser beam	<ul style="list-style-type: none"> Enlarge measuring field. The measuring field was possibly limited; see Section "MEASURING FIELD" Move object. The object is outside the measuring field vertically or is in the blind region of the sensor
The position of the created rectangle (secured measuring field) is not clear	If a rectangle was adjusted with AUTO, the LIMIT L, LIMIT R, and OFFSET functions can be used as an aid. The individual values of the rectangle are shown in this menu.
Unreliable measuring value: The measuring value jumps back and forth	<ul style="list-style-type: none"> The object is in the blind region (too close to the sensor); the displayed measuring value is a shadow of the object (fictitious edge) Use FLEX MOUNT for greater measuring reliability Avoid bright object Avoid very dark object Too much ambient light Check height of the edge set at the sensor Check measuring mode setting (MEASUREMENT TYPE)
The edges of the object are not detected	<ul style="list-style-type: none"> Object height function defines the minimum step of an edge. The edge of an object must be higher than the minimum defined step (minimum step is 2 mm) The edges of the object do not meet the requirements of an edge,

	see Section "Definition of an edge" <ul style="list-style-type: none">• The edge is outside the measuring field or the measuring field was limited, see Section MEASURING FIELD
Transmitting laser light is dim	Sync-In input is on High--> set to Low

9 Revision history

6/27/2014	tof	Manual released in version 1.0
7/11/2014	tof	Version 1.01. Adaptation graphics chapter LIVE MONITOR
4/24/2015	tof	FDA relevant information integrated. Complete revision
9/17/2015	tof	Replaced analog output curve due to an error
3/29/2017	tof	V1.2: Implementation of the sensors 11171774 and 11174280 and some minor changes
	tof	PosCon 3D changed in PosCon OXE7
10/05/2020	ehe	Added mounting advice (2.2 / 6.4.3) Added information for weak reflections (4.6.2) Added sensor influence advice sentence (6.5.3)



Baumer Group
International Sales
P.O. Box · Hummelstrasse 17 · CH-8501 Frauenfeld
Phone +41 (0)52 728 1122 · Fax +41 (0)52 728 1144
sales@baumer.com · www.baumer.com



Weitere Informationen zu dem *PosCon 3D* finden Sie unter
www.baumer.com/poscon3d

Finden Sie Ihren Partner vor Ort: www.baumer.com/worldwide