



Operating Manual

V4.9 / .XC / .I / .I.XT / .PTP / .I.PTP cameras
(Gigabit Ethernet)

V4.9 / MP cameras
(USB 3.0)

EN-US

Table of Contents

1. General Information	9
1.1 Software Licensing Information.....	11
2. General Safety Instructions	13
3. Camera Models	14
3.1 VCXG / .PTP	18
3.2 VCXG.XC.....	20
3.3 VCXG.I / .XT / .PTP	21
3.4 VCXU	27
3.5 VCXU.XC	29
4. Installation	30
4.1 Environmental Requirements.....	30
4.2 Heat Transmission	31
4.2.1 Emergency shutdown at critical Temperatures (\geq Rel. 2 only)	34
4.3 Lens mounting	37
4.4 IP Protection classes (VCXG.I / .I.XT)	38
4.5 Filter replacement	39
4.6 Cable requirements for UL conformity	39
4.7 Cleaning.....	40
4.8 Mechanical Tests.....	41
5. Pin-Assignment / LED-Signaling	42
5.1 VCXG / .PTP / .XC	42
5.1.1 Ethernet Interface.....	42
5.1.2 Power Supply and IOs.....	43
5.1.3 GPIO (General Purpose Input/Output).....	44
5.1.4 Digital-IO.....	45
5.1.5 LED Signaling.....	45
5.2 VCXG.I / .XT / .PTP	46
5.2.1 Ethernet Interface.....	46
5.2.2 Power Supply and IOs.....	46
5.2.3 Digital-IO	47
5.2.4 LED Signaling.....	48
5.3 VCXU / .XC	49
5.3.1 USB 3.0 Interface	49
5.3.2 Digital-IOs.....	49
5.3.3 GPIO (General Purpose Input/Output).....	50
5.3.4 Digital-IO.....	51
5.3.5 LED Signaling.....	51
6. Product Specifications	52
6.1 Spectral Sensitivity.....	52
6.2 Sensor position accuracy.....	61
6.2.1 VCXG / .XC / .PTP	61
6.2.2 VCXG.I / .I.XT / .I.PTP	62

6.2.3	VCXU / .XC	63
6.3	Software	64
6.3.1	Baumer GAPI	64
6.3.2	NeoAPI	64
6.3.3	3 rd Party Software	64
7.	Camera Functions	65
7.3.1	AcquisitionAbort	66
7.3.2	AcquisitionFrameCount	66
7.3.3	AcquisitionFrameRate	66
7.3.4	AcquisitionFrameRateEnable	67
7.3.5	AcquisitionMode	67
7.3.6	AcquisitionStart	68
7.3.7	AcquisitionStatus	68
7.3.8	AcquisitionStatusSelector	68
7.3.9	AcquisitionStop	69
7.3.10	ExposureAuto (except .PTP / .I.PTP)	69
7.3.11	ExposureMode	69
7.3.12	ExposureTime	70
7.3.12.1	VCXG / .XC / .I / .I.XT / .PTP / .I.PTP	71
7.3.12.3	VCXU / .XC	72
7.3.13	ExposureTimeGapMax (≥ Rel. 4 only)	73
7.3.14	ExposureTimeGapMin (≥ Rel. 4 only)	73
7.3.15	ReadoutMode	74
7.3.16	ShortExposureTimeEnable	75
7.3.17	TriggerActivation	75
7.3.18	TriggerDelay	75
7.3.19	TriggerMode	76
7.3.19.1	Timings of the image transmission VCXG	76
7.3.19.2	Timings of the image transmission VCXU / .XC	77
7.3.20	TriggerOverlap	77
7.3.21	TriggerSelector	77
7.3.22	TriggerSoftware	77
7.3.23	TriggerSource	78
7.1	Category: Action Control (GigE only)	79
7.1.1	ActionDeviceKey	79
7.1.2	ActionGroupKey	79
7.1.3	ActionGroupMask	79
7.1.4	ActionSelector	79
7.2	Category: AnalogControl	80
7.2.1	BalanceWhiteAuto (color cameras only)	80
7.2.2	BlackLevel	80
7.2.2.1	VCXG / .XC / .I / .I.XT / .PTP / .I.PTP	81
7.2.2.2	VCXU / .XC	81
7.2.3	BlackLevelSelector	82
7.2.4	Gain	82
7.2.4.1	VCXG / .XC / .I / .I.XT / .PTP / .I.PTP	83
7.2.4.2	VCXU / .XC	84
7.2.5	GainAuto (except .PTP / .I.PTP)	85
7.2.6	GainSelector	85
7.2.7	Gamma	86
7.2.8	boBlackLevelAutoAdjustEnable (SWIR only)	86
7.3	Category: AutoFeatureControl (≥ Release 3 only, except .PTP / .I.PTP)	87
7.3.1	AutoFeatureHeight	89
7.3.2	AutoFeatureOffsetX	89
7.3.3	AutoFeatureOffsetY	90
7.3.4	AutoFeatureRegionMode	90
7.3.5	AutoFeatureRegionReference	91
7.3.6	AutoFeatureRegionSelector	91
7.3.7	AutoFeatureWidth	91

7.3.8	BalanceWhiteAutoStatus	92
7.3.9	BrightnessAutoNominalValue	92
7.3.10	BrightnessAutoPriority	92
7.3.11	ExposureAutoMaxValue	93
7.3.12	ExposureAutoMinValue	94
7.3.13	GainAutoMaxValue	94
7.3.14	GainAutoMinValue	94
7.4	Category: ChunkDataControl	95
7.4.1	ChunkEnable	96
7.4.2	ChunkModeActive	96
7.4.3	ChunkSelector	96
7.4.3.1	VCXG / .XC / .I / .IXT / .PTP / .I.PTP / VCXU / .XC	97
7.5	Category: ColorTransformationControl (color cameras only)	100
7.5.1	ColorTransformationAuto (≥ Release 3 only)	100
7.5.2	ColorTransformationEnable	101
7.5.3	ColorTransformationFactoryListSelector	101
7.5.4	ColorTransformationOutputColorSpace	101
7.5.5	ColorTransformationResetToFactoryList	102
7.5.6	ColorTransformationValue	102
7.5.7	ColorTransformationValueSelector	102
7.6	Category: CounterAndTimerControl	103
7.6.1	CounterDuration	103
7.6.2	CounterEventActivation	103
7.6.3	CounterEventSource	104
7.6.4	CounterReset	104
7.6.5	CounterResetActivation	105
7.6.6	CounterResetSource	105
7.6.7	CounterSelector	105
7.6.8	CounterValue	106
7.6.9	CounterValueAtReset	106
7.6.10	FrameCounter	106
7.6.11	TimerDelay	107
7.6.12	TimerDuration	107
7.6.13	TimerSelector	107
7.6.14	TimerTriggerActivation	108
7.6.15	TimerTriggerSource	108
7.7	Category: CustomDataControl (≥ Release 3 only)	109
7.7.1	CustomData	109
7.7.2	CustomDataSelector	109
7.8	Category: DeviceControl	110
7.8.1	DeviceCharacterSet	110
7.8.2	DeviceEventChannelCount	110
7.8.3	DeviceFamilyName	110
7.8.4	DeviceFirmwareVersion	111
7.8.6	DeviceGenCPVersionMinor	111
7.8.7	DeviceLinkCommandTimeout	111
7.8.8	DeviceLinkHeartbeatMode	112
7.8.9	DeviceLinkHeartbeatTimeout	112
7.8.10	DeviceLinkSelector	112
7.8.11	DeviceLinkSpeed	113
7.8.12	DeviceLinkThroughputLimit	113
7.8.13	DeviceManufacturerInfo	113
7.8.14	DeviceModelName	114
7.8.15	DeviceRegistersEndiannes	114
7.8.16	DeviceReset	114
7.8.17	DeviceResetToDeliveryState	115
7.8.18	DeviceSFNCVersionMajor	115
7.8.19	DeviceSFNCVersionMinor	115
7.8.20	DeviceSFNCVersionSubMinor	116
7.8.21	DeviceScanType	116
7.8.22	DeviceSensorType	116
7.8.23	DeviceSerialNumber	116

7.8.24	DeviceStreamChannelCount	117
7.8.25	DeviceStreamChannelEndianness	117
7.8.26	DeviceStreamChannelPacketSize	117
7.8.27	DeviceStreamChannelSelector	117
7.8.28	DeviceStreamChannelType	118
7.8.29	DeviceTLType	118
7.8.30	DeviceTLVersionMajor	118
7.8.31	DeviceTLVersionMinor	118
7.8.32	DeviceTLVersionSubMinor	119
7.8.33	DeviceTemperature	119
7.8.34	DeviceTemperatureExceeded	119
7.8.35	DeviceTemperatureSelector	119
7.8.36	DeviceTemperatureStatus	120
7.8.37	DeviceTemperatureStatusTransition	120
7.8.38	DeviceTemperatureStatusTransitionSelector (≥ Rel. 2 only)	120
7.8.39	DeviceTemperatureUnderrun (several models)	121
7.8.40	DeviceType	121
7.8.41	DeviceUserID	121
7.8.42	DeviceVendorName	121
7.8.43	DeviceVersion	122
7.8.44	ReadOutTime	122
7.8.45	TimestampLatch	122
7.8.46	TimestampLatchValue	122
7.8.47	TimestampLatchValuePtpDays	123
7.8.48	TimestampReset	123
7.8.49	USB2SupportEnable	123
7.9	Category: DigitalIOControl	124
7.9.1	LineDebouncerHighTimeAbs	126
7.9.2	LineDebouncerLowTimeAbs	126
7.9.3	LineFormat (only VCXG.I / .XT / .PTP)	127
7.9.4	LineInverter	128
7.9.5	LineMode	128
7.9.6	LinePWMConfigurationMode (only VCXG.I / .XT / .PTP)	129
7.9.7	LinePWMDuration (only VCXG.I / .XT / .PTP)	130
7.9.8	LinePWMDutyCycle (only VCXG.I / .XT / .PTP)	130
7.9.9	LinePWMMaxDuration (only VCXG.I / .XT / .PTP)	131
7.9.10	LinePWMMaxDutyCycle (only VCXG.I / .XT / .PTP)	131
7.9.11	LinePWMMode (only VCXG.I / .XT / .PTP)	131
7.9.12	LinePWMOffTime (only VCXG.I / .XT / .PTP)	132
7.9.13	LinePWMPeriodTime (only VCXG.I / .XT / .PTP)	132
7.9.14	LineSelector	133
7.9.14.1	General Purpose Input/Output - GPIO (except VCXG.I/.I.XT/.PTP)	134
7.9.15	LineSource	135
7.9.16	LineStatus	137
7.9.17	LineStatusAll	137
7.9.18	UserOutputSelector	137
7.9.19	UserOutputValue	138
7.9.20	UserOutputValueAll	138
7.10	Category: EventControl	139
7.10.20.1	DeviceTemperaturStatusChanged	143
7.10.1	EventNotification	143
7.10.2	EventSelector	144
7.10.3	LostEventCounter	144
7.11	Category: ImageFormatControl	145
7.11.1	BinningHorizontal	148
7.11.1.1	VCXG / .XC / .I / .I.XT / .PTP / .I.PTP	149
7.11.1.2	VCXU / .XC	150
7.11.2	BinningHorizontalMode	151
7.11.3	BinningSelector	151
7.11.4	BinningVertical	152
7.11.4.1	VCXG / .XC / .I / .I.XT / .PTP / .I.PTP	152
7.11.4.2	VCXU / .XC	153
7.11.5	BinningVerticalMode	154

7.11.6 Category: ImageFormatControl → CalibrationControl (MP cameras only)	155
7.11.6.1 CalibrationAngleOfPolarizationOffset	156
7.11.6.2 CalibrationEnable	156
7.11.6.3 CalibrationMatrixValue	156
7.11.6.4 CalibrationMatrixValueSelector	157
7.11.7 ComponentEnable (MP cameras only)	157
7.11.8 ComponentSelector (MP cameras only)	157
7.11.9 Height	158
7.11.9.1 VCXG / .XC / .I / .I.XT / .PTP / .I.PTP	159
7.11.9.2 VCXU / .XC	160
7.11.10 HeightMax	161
7.11.10.1 VCXG / .XC / .I / .I.XT / .PTP / .I.PTP	161
7.11.10.2 VCXU / .XC	162
7.11.11 OffsetX	163
7.11.12 OffsetY	164
7.11.13 PixelFormat	164
7.11.13.1 VCXG / .XC / .I / .I.XT / .PTP / .I.PTP	166
7.11.13.2 VCXU / .XC	167
7.11.14 ReverseX (mono cameras / pixel formats only)	168
7.11.15 ReverseY (monochrome cameras / pixel formats only)	169
7.11.16 SensorHeight	169
7.11.17 SensorName (≥ Release 3 only)	169
7.11.18 SensorPixelHeight (≥ Release 3 only)	170
7.11.19 SensorPixelWidth (≥ Release 3 only)	170
7.11.20 SensorShutterMode	171
7.11.21 SensorWidth	173
7.11.22 TestPattern	173
7.11.23 TestPatternGeneratorSelector	174
7.11.24 Width	174
7.11.24.1 VCXG / .XC / .I / .I.XT / .PTP / .I.PTP	175
7.11.24.2 VCXU / .XC	176
7.11.25 WidthMax	177
7.11.25.1 VCXG / .XC / .I / .I.XT / .PTP / .I.PTP	177
7.11.25.2 VCXU / .XC	178
7.11.26 boOpticalBlackPixelsConfigurationMode (SWIR only)	179
7.11.27 boOpticalBlackPixelsWidth (SWIR only)	180
7.12 ImageProcessingControl (SWIR only)	180
7.12.1 DynamicPixelCorrectionEnable	181
7.12.2 DynamicPixelCorrectionFactor	181
7.12.3 DynamicPixelCorrectionThreshold	181
7.13 Category: LUTControl	182
7.13.1 DefectPixelCorrection	184
7.13.2 DefectPixelListEntryActive	184
7.13.3 DefectPixelListEntryPosX	185
7.13.4 DefectPixelListEntryPosY	185
7.13.5 DefectPixelListIndex	185
7.13.6 DefectPixelListSelector	185
7.13.7 Fixed Pattern Noise Correction (FPNC)	186
7.13.7.1 VCXG / .XC / .I / .I.XT / .PTP / .I.PTP	186
7.13.7.2 VCXU / .XC	187
7.13.8 LUTContent	188
7.13.9 LUTEnable	188
7.13.10 LUTIndex	188
7.13.11 LUTSelector	189
7.13.12 LUTValue	189
7.14 Category: MemoryManagement (≥ Rel. 3 only)	189
7.14.1 MemoryMaxBlocks	189
7.15 Category: SequencerControl (≥ Rel. 2 only)	190
7.15.1 SequencerConfigurationMode	191
7.15.2 SequencerFeatureEnable	191
7.15.3 SequencerFeatureSelector	192
7.15.4 SequencerMode	193
7.15.5 SequencerPathSelector	193

7.15.6	SequencerSetActive	193
7.15.7	SequencerSetLoad	194
7.15.8	SequencerSetNext	194
7.15.9	SequencerSetSave	194
7.15.10	SequencerSetSelector	194
7.15.11	SequencerSetStart	195
7.15.12	SequencerTriggerActivation	195
7.15.13	SequencerTriggerSource	196
7.16	Category: TransportLayerControl	196
7.16.1	EnergyEfficientEthernetEnable (≥ Rel. 3 only)	196
7.16.2	Category: TransportLayerControl → GigEVision	197
7.16.2.1	GVSPConfigurationBlockID64Bit	197
7.16.2.2	GevCCP	197
7.16.2.3	GevCurrentDefaultGateway	197
7.16.2.4	GevCurrentIPAddress	198
7.16.2.5	GevCurrentIPConfigurationDHCP	198
7.16.2.6	GevCurrentIPConfigurationLLA	198
7.16.2.7	GevCurrentIPConfigurationPersistentIP	199
7.16.2.8	GevCurrentSubnetMask	199
7.16.2.9	GevFirstURL	199
7.16.2.10	GevGVCPExtendedStatusCodes	199
7.16.2.11	GevGVCPExtendedStatusCodesSelector	200
7.16.2.12	GevGVCPPendingAck	200
7.16.2.13	GevIPConfigurationStatus	200
7.16.2.14	GevInterfaceSelector	201
7.16.2.15	GevMACAddress	201
7.16.2.16	GevMCDA	201
7.16.2.17	GevMCPHostPort	201
7.16.2.18	GevMCRC	202
7.16.2.19	GevMCSP	202
7.16.2.20	GevMCTT	202
7.16.2.21	GevNumberOfInterfaces	202
7.16.2.22	GevPAUSEFrameReception	203
7.16.2.23	GevPersistentDefaultGateway	203
7.16.2.24	GevPersistentIPAddress	203
7.16.2.25	GevPersistentSubnetMask	203
7.16.2.26	GevPrimaryApplicationIPAddress	204
7.16.2.27	GevPrimaryApplicationSocket	204
7.16.2.28	GevPrimaryApplicationSwitchoverKey	204
7.16.2.29	GevSCDA	204
7.16.2.30	GevSCFTD	205
7.16.2.31	GevSCPD	205
7.16.2.32	GevSCPHostPort	205
7.16.2.33	GevSCPIInterfaceIndex	205
7.16.2.34	GevSCPSDoNotFragment	206
7.16.2.35	GevSCPSFireTestPacket	206
7.16.2.36	GevSCPSPacketSize	206
7.16.2.37	GevSCSP	206
7.16.2.38	GevSecondURL	207
7.16.2.39	GevStreamChannelSelector	207
7.16.2.40	GevSupportedOption	207
7.16.2.41	GevSupportedOptionSelector	208
7.16.2.42	InterfaceSpeedMode	209
7.16.3	PayloadSize	209
7.16.4	Category: Category: TransportLayerControl → PtpControl (.PTP only)	210
7.16.4.1	PtpClockAccuracy	212
7.16.4.2	PtpClockID	212
7.16.4.3	PtpDataSetLatch	212
7.16.4.4	PtpEnable	213
7.16.4.5	PtpGrandmasterClockID	213
7.16.4.6	PtpMode	213
7.16.4.7	PtpOffsetFromMaster	214
7.16.4.8	PtpParentClockID	214
7.16.4.9	PtpServoStatus	214

7.16.4.10 PtpStatus	215
7.16.5 Category: TransportLayerControl → USB3Vision	215
7.16.5.1 InterfaceSpeedMode.....	215
7.16.5.2 SIControl.....	216
7.16.5.3 SIPayloadFinalTransfer1Size	216
7.16.5.4 SIPayloadFinalTransfer2Size	216
7.16.5.5 SIPayloadTransferCount.....	216
7.16.5.6 SIPayloadTransferSize	217
7.17 Category: UserSetControl.....	217
7.17.1 UserSetDefault	217
7.17.2 UserSetFeatureEnable	218
7.17.3 UserSetFeatureSelector	218
7.17.4 UserSetLoad	221
7.17.5 UserSetSave	221
7.17.6 UserSetSelector	221
7.18 Category: boCalibrationData.....	222
7.18.1 boCalibrationAngularAperture	222
7.18.2 boCalibrationDataConfigurationMode	222
7.18.3 boCalibrationDataSave	222
7.18.4 boCalibrationDataVersion.....	223
7.18.5 boCalibrationFocalLength	223
7.18.6 boCalibrationMatrixSelector	223
7.18.7 boCalibrationMatrixValue.....	223
7.18.8 boCalibrationMatrixValueSelector	224
7.18.9 boCalibrationVectorSelector.....	224
7.18.10 boCalibrationVectorValue	224
7.18.11 boCalibrationVectorValueSelector	225
7.18.12 boGeometryDistortionValue.....	225
7.18.13 boGeometryDistortionValueSelector	225
8. VCXG /.XC/.I.I.XT/.PTP /.I.PTP – Interface Functionalities	226
8.1 Device Information	226
8.2 Packet Size and Maximum Transmission Unit (MTU).....	226
8.3 Inter Packet Gap (IPG)	226
8.3.1 Example 1: Multi Camera Operation – Minimal IPG.....	227
8.3.2 Example 2: Multi Camera Operation – Optimal IPG.....	227
8.4 Transmission Delay.....	228
8.4.1 Time Saving in Multi-Camera Operation	228
8.4.2 Configuration Example	229
8.5 Multicast.....	231
8.6 IP Configuration	232
8.6.1 Persistent IP	232
8.6.2 DHCP (Dynamic Host Configuration Protocol).....	232
8.6.3 LLA	233
8.6.4 Force IP	233
8.7 Packet Resend.....	234
8.7.1 Normal Case.....	234
8.7.2 Fault 1: Lost Packet within Data Stream	234
8.7.3 Fault 2: Lost Packet at the End of the Data Stream	235
8.7.4 Termination Conditions	235
8.8 Message Channel	236
8.8.1 Event Generation	236
8.9 Action Command / Trigger over Ethernet.....	237
8.9.1 Example: Triggering Multiple Cameras	237
9. VCXU – Interface Functionalities	238
9.1 Device Information	238

1. General Information

Thanks for purchasing a camera of the Baumer family. This User's Guide describes how to connect, set up and use the camera.



Read this manual carefully and observe the notes and safety instructions!

Support

In the case of any questions please contact our Technical & Application Support Center.

Worldwide: **Baumer Optronic GmbH**
Badstrasse 30
DE-01454 Radeberg, Germany

Tel: +49 (0)3528 4386 845

Website: www.baumer.com

E-mail: support.cameras@baumer.com

Target group for this User's Guide

This User's Guide is aimed at experienced users, which want to integrate camera(s) into a vision system.

Intended Use

The camera is used to capture images that can be transferred over a GigE interface (VCXG / .I / .I.XT / .PTP / .I.PTP) or a USB 3.0 interface (VCXU / .XC) to a PC.

Classification of the safety instructions

In the User's Guide, the safety instructions are classified as follows:

Notice

Gives helpful notes on operation or other general recommendations.



Caution



Indicates a possibly dangerous situation. If the situation is not avoided, slight or minor injury could result or the device may be damaged.



Danger!



Indicates an immediate imminent danger. If the danger is not avoided, the consequences are death or very serious injury.

Transport / Storage

Transport the camera only in the original packaging. When the camera is not installed, then storage the camera in original packaging.

Disposal



Dispose of outdated products with electrical or electronic circuits, not in the normal domestic waste, but rather according to your national law and the directives 2002/96/EC and 2006/66/EC for recycling within the competent collectors.



Through the proper disposal of obsolete equipment will help to save valuable resources and prevent possible adverse effects on human health and the environment.

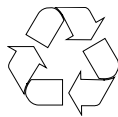

The return of the packaging to the material cycle helps conserve raw materials and reduces the production of waste. When no longer required, dispose of the packaging materials in accordance with the local regulations in force.

Keep the original packaging during the warranty period in order to be able to pack the device properly in the event of a warranty claim.

Warranty Notes

If it is obvious that the device is / was dismantled, reworked or repaired by other than Baumer technicians, Baumer Optronic will not take any responsibility for the subsequent performance and quality of the device!

Copyright

Any duplication or reprinting of this documentation, in whole or in part, and the reproduction of the illustrations even in modified form is permitted only with the written approval of Baumer. The information in this document is subject to change without notice.

1.1 Software Licensing Information

The software in the camera includes the LWIP TCP/IP implementation. The copyright information for this implementation is as follows:

Copyright (c) 2001, 2002 Swedish Institute of Computer Science. All rights reserved.

Redistribution and use in source and binary forms, with or without modification, are permitted provided that the following conditions are met:

1. Redistributions of source code must retain the above copyright notice, this list of conditions and the following disclaimer.
2. Redistributions in binary form must reproduce the above copyright notice, this list of conditions and the following disclaimer in the documentation and/or other materials provided with the distribution.
3. The name of the author may not be used to endorse or promote products derived from this software without specific prior written permission.

THIS SOFTWARE IS PROVIDED BY THE AUTHOR ``AS IS" AND ANY EXPRESS OR IMPLIED WARRANTIES, INCLUDING, BUT NOT LIMITED TO, THE IMPLIED WARRANTIES OF MERCHANTABILITY AND FITNESS FOR A PARTICULAR PURPOSE ARE DISCLAIMED.

IN NO EVENT SHALL THE AUTHOR BE LIABLE FOR ANY DIRECT, INDIRECT, INCIDENTAL, SPECIAL, EXEMPLARY, OR CONSEQUENTIAL DAMAGES (INCLUDING, BUT NOT LIMITED TO, PROCUREMENT OF SUBSTITUTE GOODS OR SERVICES; LOSS OF USE, DATA, OR PROFITS; OR BUSINESS INTERRUPTION) HOWEVER CAUSED AND ON ANY THEORY OF LIABILITY, WHETHER IN CONTRACT, STRICT LIABILITY, OR TORT (INCLUDING NEGLIGENCE OR OTHERWISE) ARISING IN ANY WAY OUT OF THE USE OF THIS SOFTWARE, EVEN IF ADVISED OF THE POSSIBILITY OF SUCH DAMAGE.

The software in the camera includes the ptpd implementation. The copyright information for this implementation is as follows:

Copyright (c) 2015	Wojciech Owczarek.
Copyright (c) 2014	Perseus Telecom.
Copyright (c) 2013-2014	Harlan Stenn, George N. Neville-Neil, Wojciech Owczarek, Jan Breuer.
Copyright (c) 2011-2012	George V. Neville-Neil, Steven Kreuzer, Martin Burnicki, Jan Breuer, Wojciech Owczarek, Gael Mace, Alexandre Van Kempen, Inaqui Delgado, Rick Ratzel, National Instruments.

Copyright (c) 2009-2010

George V. Neville-Neil,
Steven Kreuzer,
Martin Burnicki,
Jan Breuer,
Gael Mace,
Alexandre Van Kempen.

Copyright (c) 2005-2008

Kendall Correll, Aidan Williams

All Rights Reserved

Redistribution and use in source and binary forms, with or without modification, are permitted provided that the following conditions are met:

1. Redistributions of source code must retain the above copyright notice this list of conditions and the following disclaimer.
2. Redistributions in binary form must reproduce the above copyright notice, this list of conditions and the following disclaimer in the documentation and/or other materials provided with the distribution.

THIS SOFTWARE IS PROVIDED BY THE AUTHORS "AS IS" AND ANY EXPRESS OR IMPLIED WARRANTIES, INCLUDING, BUT NOT LIMITED TO, THE IMPLIED WARRANTIES OF MERCHANTABILITY AND FITNESS FOR A PARTICULAR PURPOSE ARE DISCLAIMED. IN NO EVENT SHALL THE AUTHORS OR CONTRIBUTORS BE LIABLE FOR ANY DIRECT, INDIRECT, INCIDENTAL, SPECIAL, EXEMPLARY, OR CONSEQUENTIAL DAMAGES (INCLUDING, BUT NOT LIMITED TO, PROCUREMENT OF SUBSTITUTE GOODS OR SERVICES; LOSS OF USE, DATA, OR PROFITS; OR BUSINESS INTERRUPTION) HOWEVER CAUSED AND ON ANY THEORY OF LIABILITY, WHETHER IN CONTRACT, STRICT LIABILITY, OR TORT (INCLUDING NEGLIGENCE OR OTHERWISE) ARISING IN ANY WAY OUT OF THE USE OF THIS SOFTWARE, EVEN IF ADVISED OF THE POSSIBILITY OF SUCH DAMAGE.

2. General Safety Instructions

Caution

Heat can damage the camera. Provide adequate dissipation of heat, to ensure that the temperature does not exceed the value (see Heat Transmission).



As there are numerous possibilities for installation, Baumer recommends no specific method for proper heat dissipation, but suggest the following principles:

- operate the cameras only in mounted condition
- mounting in combination with forced convection may provide proper heat dissipation

Caution



Observe precautions for handling electrostatic sensitive devices!

Caution







The camera is a class A device (DIN EN 55022:2011). It can cause radio interference in residential environments. Should this happen, you must take reasonable measures to eliminate the interference.

3. Camera Models

All Baumer cameras of these family are characterized by:

- | | | | | | | | | | | | | | | | | | | | |
|----------------------------|---|-------------|--|------------|--|--------|-----------------------------|--|--|--|---|--|---------------------------------------|---------|---------------------------------------|------|---|--|---------------------------------------|
| Best image quality | ▪ Low noise and structure-free image information | | | | | | | | | | | | | | | | | | |
| Flexible image acquisition | ▪ Industrially-compliant process interface with parameter setting capability | | | | | | | | | | | | | | | | | | |
| Fast image transfer | <table border="0"> <tr> <td style="vertical-align: top;">VCXG/.XC/.I</td> <td>▪ Reliable transmission up to 1000 Mbit/sec according to IEEE802.3</td> </tr> <tr> <td style="vertical-align: top;">.I.XT/PTP/</td> <td>▪ Cable length up to 100 m</td> </tr> <tr> <td style="vertical-align: top;">.I.PTP</td> <td>▪ PoE (Power over Ethernet)</td> </tr> <tr> <td></td> <td>▪ Baumer driver for high data volume with low CPU load</td> </tr> <tr> <td></td> <td>▪ High-speed multi-camera operation</td> </tr> <tr> <td></td> <td>▪ GenICam™ and GigE Vision® compliant</td> </tr> <tr> <td style="vertical-align: top;">VCXG.XC</td> <td>▪ internal cool pipes for cooling air</td> </tr> <tr> <td style="vertical-align: top;">VCXU</td> <td>▪ Reliable transmission at 5000 Mbit/sec according to USB 3.0 (v1.0.1) standard</td> </tr> <tr> <td></td> <td>▪ GenICam™ and USB3 Vision™ compliant</td> </tr> </table> | VCXG/.XC/.I | ▪ Reliable transmission up to 1000 Mbit/sec according to IEEE802.3 | .I.XT/PTP/ | ▪ Cable length up to 100 m | .I.PTP | ▪ PoE (Power over Ethernet) | | ▪ Baumer driver for high data volume with low CPU load | | ▪ High-speed multi-camera operation | | ▪ GenICam™ and GigE Vision® compliant | VCXG.XC | ▪ internal cool pipes for cooling air | VCXU | ▪ Reliable transmission at 5000 Mbit/sec according to USB 3.0 (v1.0.1) standard | | ▪ GenICam™ and USB3 Vision™ compliant |
| VCXG/.XC/.I | ▪ Reliable transmission up to 1000 Mbit/sec according to IEEE802.3 | | | | | | | | | | | | | | | | | | |
| .I.XT/PTP/ | ▪ Cable length up to 100 m | | | | | | | | | | | | | | | | | | |
| .I.PTP | ▪ PoE (Power over Ethernet) | | | | | | | | | | | | | | | | | | |
| | ▪ Baumer driver for high data volume with low CPU load | | | | | | | | | | | | | | | | | | |
| | ▪ High-speed multi-camera operation | | | | | | | | | | | | | | | | | | |
| | ▪ GenICam™ and GigE Vision® compliant | | | | | | | | | | | | | | | | | | |
| VCXG.XC | ▪ internal cool pipes for cooling air | | | | | | | | | | | | | | | | | | |
| VCXU | ▪ Reliable transmission at 5000 Mbit/sec according to USB 3.0 (v1.0.1) standard | | | | | | | | | | | | | | | | | | |
| | ▪ GenICam™ and USB3 Vision™ compliant | | | | | | | | | | | | | | | | | | |
| Perfect integration | <ul style="list-style-type: none"> ▪ Flexible generic programming interface (Baumer GAPI) for all Baumer cameras ▪ Powerful Software Development Kit (SDK) with sample codes and help files for simple integration ▪ Baumer viewer for all camera functions ▪ GenICam™ compliant XML file to describe the camera functions ▪ Supplied with installation program with automatic camera recognition for simple commissioning | | | | | | | | | | | | | | | | | | |
| Compact design | <ul style="list-style-type: none"> ▪ Light weight ▪ flexible assembly | | | | | | | | | | | | | | | | | | |
| Reliable operation | <ul style="list-style-type: none"> ▪ State-of-the-art camera electronics and precision mechanics ▪ Low power consumption and minimal heat generation | | | | | | | | | | | | | | | | | | |
| Supported standards | <table border="0"> <tr> <td style="vertical-align: top;">VCXG</td> <td>▪ GenICam™ SFNC 2.1 Rel. 2.0: SFNC 2.3 Rel. 3.0: SFNC 2.4 Rel. 4.0: SNFC 2.4</td> </tr> <tr> <td></td> <td>▪ IEEE 1588™-2008 (only .PTP / .I.PTP)</td> </tr> <tr> <td style="vertical-align: top;">VCXU</td> <td>▪ USB3 Vision™ 1.0.1</td> </tr> <tr> <td></td> <td>▪ GenICam™ GenCP 1.1</td> </tr> <tr> <td></td> <td>▪ GenICam™ SFNC 2.1 Rel. 2.0: SFNC 2.3 Rel. 3.0: SFNC 2.4</td> </tr> </table> | VCXG | ▪ GenICam™ SFNC 2.1 Rel. 2.0: SFNC 2.3 Rel. 3.0: SFNC 2.4 Rel. 4.0: SNFC 2.4 | | ▪ IEEE 1588™-2008 (only .PTP / .I.PTP) | VCXU | ▪ USB3 Vision™ 1.0.1 | | ▪ GenICam™ GenCP 1.1 | | ▪ GenICam™ SFNC 2.1 Rel. 2.0: SFNC 2.3 Rel. 3.0: SFNC 2.4 | | | | | | | | |
| VCXG | ▪ GenICam™ SFNC 2.1 Rel. 2.0: SFNC 2.3 Rel. 3.0: SFNC 2.4 Rel. 4.0: SNFC 2.4 | | | | | | | | | | | | | | | | | | |
| | ▪ IEEE 1588™-2008 (only .PTP / .I.PTP) | | | | | | | | | | | | | | | | | | |
| VCXU | ▪ USB3 Vision™ 1.0.1 | | | | | | | | | | | | | | | | | | |
| | ▪ GenICam™ GenCP 1.1 | | | | | | | | | | | | | | | | | | |
| | ▪ GenICam™ SFNC 2.1 Rel. 2.0: SFNC 2.3 Rel. 3.0: SFNC 2.4 | | | | | | | | | | | | | | | | | | |

Conformity

CE	We declare, under our sole responsibility, that the described Baumer cameras conform with the directives of the CE.	
UL	The camera has been tested by UL (Underwriters Laboratories) and complies with the requirements of the standards: <ul style="list-style-type: none">▪ UL 61010-1 Edition 3 - Revision Date: 2016/04/29▪ UL 61010-2-201 Edition 2 - Published: 2018/05/14▪ CSA C22.2 NO. 61010-1-12 Edition 3 - Update No. 2: 2016/04▪ CSA C22.2 NO. 61010-2-201:18 Edition 2 - Published: 2018/02	
UR	The camera has been tested by UL (Underwriters Laboratories) and complies with the requirements under specified installation conditions of the standards: <ul style="list-style-type: none">▪ UL 61010-1 Edition 3 - Revision Date: 2016/04/29▪ UL 61010-2-201 Edition 2 - Published: 2018/05/14▪ CSA C22.2 NO. 61010-1-12 Edition 3 - Update No. 2: 2016/04▪ CSA C22.2 NO. 61010-2-201:18 Edition 2 - Published: 2018/02	
KC	Several of the described Baumer VCX cameras conform with the directives of the Korean Conformity. (see table on next page)	

Korean Conformity (Registration of Broadcasting and Communication Equipments)

VCXG

Product	Article No.	Registration No.	Date of Registration
Monochrome			
VCXG-02M	11165842	MSIP-REI-BkR-VCXG-13M	2017-05-02
VCXG-04M	11183216	MSR-R-BkR-VCXG-15M	2021-08-06
VCXG-13M	11164973	MSIP-REI-BkR-VCXG-13M	2017-05-02
VCXG-23M	11165941	R-R-BkR-VCXG-23C	2021-05-13
VCXG-24M	11165944	R-R-BkR-VCXG-23C	2021-05-13
VCXG-25M	11165829	MSIP-REI-BkR-VCXG-53M	2017-05-02
VCXG-32M	11165949	MSIP-REI-BkR-VCXG-51C	2017-05-02
VCXG-32M.PTP	11213084	MSIP-REI-BkR-VCXG-51C	2019-12-10
VCXG-50MP	11206489	MSIP-REI-BkR-VCXG-51C	2019-12-10
VCXG-51M	11165952	MSIP-REI-BkR-VCXG-51C	2017-05-02
VCXG-51M.PTP	11217714	MSIP-REI-BkR-VCXG-51C	2019-12-10
VCXG-53M	11151554	MSIP-REI-BkR-VCXG-53M	2017-05-02
VCXG-91M	11173890	MSIP-REI-BkR-VCXG-124M	2017-05-02
VCXG-124M	11172630	MSIP-REI-BkR-VCXG-124M	2017-05-02
VCXG-125M.R	11175753	MSIR-R-BkR-VCXG-125MR	019-12-27
VCXG-201M.R	11194343	R-REI-BkR-VCXG-201MR	2018-07-10
Color			
VCXG-02C	11165843	MSIP-REI-BkR-VCXG-13M	2017-05-02
VCXG-04C	11183217	MSR-R-BkR-VCXG-15M	2021-08-06
VCXG-13C	11164974	MSIP-REI-BkR-VCXG-13M	2017-05-02
VCXG-23C	11165942	R-R-BkR-VCXG-23C	2021-05-13
VCXG-24C	11165943	R-R-BkR-VCXG-23C	2021-05-13
VCXG-25C	11165828	MSIP-REI-BkR-VCXG-53M	2017-05-02
VCXG-32C	11165950	MSIP-REI-BkR-VCXG-51C	2017-05-02
VCXG-32C.PTP	11217716	MSIP-REI-BkR-VCXG-51C	2019-12-10
VCXG-51C	11165953	MSIP-REI-BkR-VCXG-51C	2017-05-02
VCXG-51C.PTP	11217715	MSIP-REI-BkR-VCXG-51C	2019-12-10
VCXG-53C	11151555	MSIP-REI-BkR-VCXG-53M	2017-05-02
VCXG-91C	11173819	MSIP-REI-BkR-VCXG-124M	2017-05-02
VCXG-124C	11172609	MSIP-REI-BkR-VCXG-124M	2017-05-02
VCXG-125C.R	11175752	MSIR-R-BkR-VCXG-125MR	2019-12-27
VCXG-201C.R	11172631	R-REI-BkR-VCXG-201MR	2018-07-10

VCXG.I / .XT / .PTP

Product	Article No.	Registration No.	Date of Registration
Monochrome			
VCXG-13M.I.XT	11188957	R-R-BkR-VCXG-13MI	2019-12-17
VCXG-15M.I.XT	11194678	R-R-BkR-VCXG-15MI	2019-11-07
VCXG-32M.I	11186791	R-R-BkR-VCXG-51MI	2020-12-24
VCXG-32M.I.PTP	11217696	R-R-BkR-VCXG-51MI	2020-12-24
VCXG-32M.I.XT	11188950	R-R-BkR-VCXG-51MI	2020-12-24
VCXG-51M.I	11186793	R-R-BkR-VCXG-51MI	2020-12-24
VCXG-51M.I.PTP	11217699	R-R-BkR-VCXG-51MI	2020-12-24
VCXG-51M.I.XT	11188955	R-R-BkR-VCXG-51MI	2020-12-24
Color			
VCXG-15C.I.XT	11194679	R-R-BkR-VCXG-15MI	2019-11-07
VCXG-32C.I	11186790	R-R-BkR-VCXG-51MI	2020-12-24
VCXG-32C.I.PTP	11217697	R-R-BkR-VCXG-51MI	2020-12-24
VCXG-32C.I.XT	11188951	R-R-BkR-VCXG-51MI	2020-12-24
VCXG-51C.I	11186792	R-R-BkR-VCXG-51MI	2020-12-24
VCXG-51C.I.PTP	11217698	R-R-BkR-VCXG-51MI	2020-12-24
VCXG-51C.I.XT	11188952	R-R-BkR-VCXG-51MI	2020-12-24

VCXU

Product	Article No.	Registration No.	Date of Registration
Monochrome			
VCXU-02M	11165914	MSIP-REI-BkR-VCXU13M	2017-04-18
VCXU-13M	11165908	MSIP-REI-BkR-VCXU13M	2017-04-18
VCXU-25M	11165905	R-R-BkR-VCXU-53M	2020-12-08
VCXU-31M	11165812	MSIP-REI-BkR-VCXU-50M	2017-04-28
VCXU-50M	11151564	MSIP-REI-BkR-VCXU-50M	2017-04-28
VCXU-51M	11164500	MSIP-REI-BkR-VCXU-50M	2017-04-28
VCXU-53M	11165900	R-R-BkR-VCXU-53M	2020-12-08
VCXU-124M	11172606	R-R-BkR-VCXU-123M	2019-06-05
Color			
VCXU-02C	11165913	MSIP-REI-BkR-VCXU13M	2017-04-18
VCXU-13C	11165907	MSIP-REI-BkR-VCXU13M	2017-04-18
VCXU-25C	11165903	R-R-BkR-VCXU-53M	2020-12-08
VCXU-31C	11165813	MSIP-REI-BkR-VCXU-50M	2017-04-28
VCXU-50C	11151566	MSIP-REI-BkR-VCXU-50M	2017-04-28
VCXU-51C	11164501	MSIP-REI-BkR-VCXU-50M	2017-04-28
VCXU-53C	11165901	R-R-BkR-VCXU-53M	2020-12-08
VCXU-124C	11172608	R-R-BkR-VCXU-123M	2019-06-05

Release Version

Notice

Identification of Release version

- Label on camera ("R2.0" is Release 2.0)
- Baumer GAPI 2.x Camera Explorer / Category: *Device Control* → *Device Version* (Release 1: R1.x.x / Release 2: R2.x.x)

3.1 VCXG / .PTP

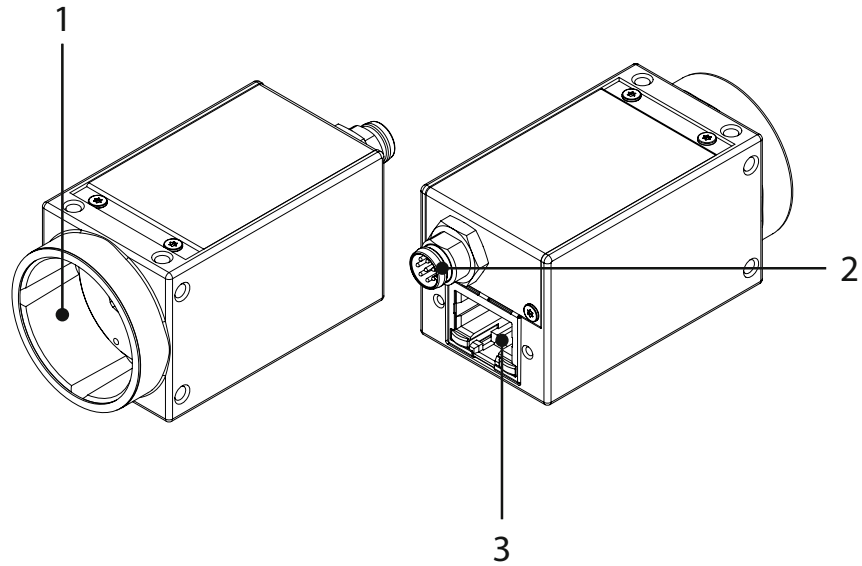

No.	Description	No.	Description
1	Lens mount (C-Mount)	3	Ethernet Port (PoE) / Signaling LED's
2	Power supply / Digital-IO		

Camera Type	Sensor Size	Resolution	Full Frames ¹⁾ [max. fps]
Monochrome / Color			
VCXG-02M / VCXG-02C	1/4"	640 × 480	595 403
VCXG-04M / VCXG-04C	1/2.9"	720 × 540	439.5 318
VCXG-13M / VCXG-13C	1/2"	1280 × 1024	145 94
VCXG-13NIR	1/2"	1280 × 1024	145 94
VCXG-15M / VCXG-15C	1/1.8"	1440 × 1080	120 79
VCXG-22M.R / VCXG-22C.R	1/2"	1920 × 1080	89 60
VCXG-23M / VCXG-23C	1/1.2"	1920 × 1200	81.5 53.5
VCXG-24M / VCXG-24C	1/1.2"	1920 × 1200	38.5
VCXG-25M / VCXG-25C	2/3"	1920 × 1200	59 53
VCXG-32M / VCXG-32C	1/1.8"	2048 × 1536	55.5 39.5
VCXG-32M.PTP / VCXG-32C.PTP	1/1.8"	2048 × 1536	55.5 39.5
VCXG-50MP	2/3"	2448 × 2048	36 24
VCXG-51M / VCXG-51C	2/3"	2448 × 2048	35.5 23.5
VCXG-51M.PTP / VCXG-51C.PTP	2/3"	2448 × 2048	35.5 23.5
VCXG-53M / VCXG-53C	1"	2592 × 2048	28 23.5
VCXG-53NIR	1"	2592 × 2048	28 23.5
VCXG-82M / VCXG-82C	2/3"	2848 × 2832	15 15
VCXG-65M.R / VCXG-65C.R	1/1.8"	3072 × 2048	29 16
VCXG-91M / VCXG-91C	1"	4096 × 2160	21 13
VCXG-124M / VCXG-124C	1.1"	4096 × 3000	15 10
VCXG-124M.PTP / VCXG-124C.PTP	1.1"	4096 × 3000	15 10
VCXG-125M.R / VCXG-125C.R	1/1.9"	4000 × 3000	15 10
VCXG-127M / VCXG-127C	1/1.1"	4096 × 2992	10 10
VCXG-201M.R / VCXG-201C.R	1"	5472 × 3648	9 6
VCXG-204M / VCXG-204C	1/1.1"	4480 × 4496	6 6
VCXG-241M	1.2"	5312 × 4600 4592 ²⁾	5 5
VCXG-241C		5312 × 4592	

¹⁾Burst Mode (image acquisition in the camera's internal memory)

²⁾≥ Rel. 4.0

Dimensions

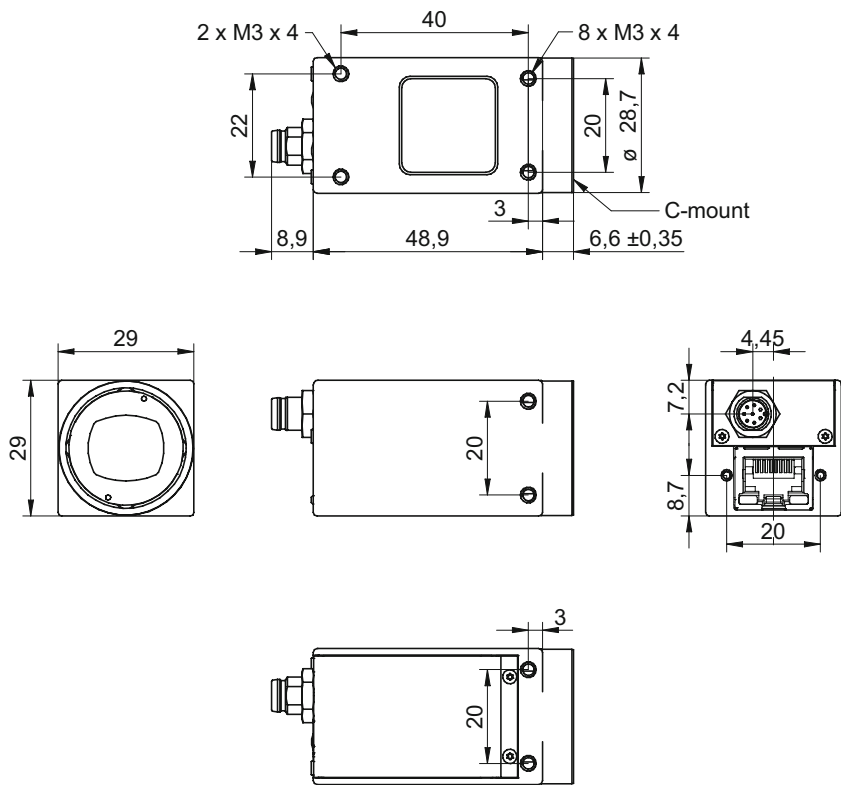

3.2 VCXG.XC

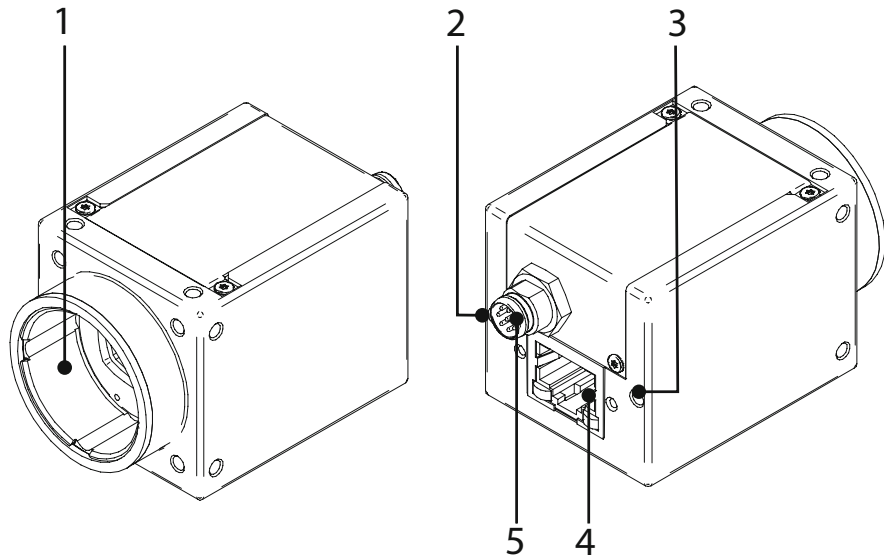

Notice

VCXG-03SWIR.XC
VCXG-14SWIR.XC

Dual Use Classification (ECCN/AL: 6A003B)

This product is subject to statutory export control regulations and may require written information on intended end use and final destination!

No.	Description	No.	Description
1	Lens mount (C-Mount)	4	Ethernet Port (PoE) / Signaling LED's
2	Cooling pipe intake	5	Power supply / Digital-I/O
3	Cooling pipe outlet		

Camera Type	Sensor Size	Resolution	Full Frames ¹⁾ [max. fps]
Monochrome			
VCXG-03SWIR.XC	1/2"	656 × 520	237 237
VCXG-14SWIR.XC	1/2"	1296 × 1032	71 71
VCXG-51M.XC	2/3"	2448 × 2048	35.5 23.5

¹⁾ Burst Mode (image acquisition in the camera's internal memory) | interface

Dimensions

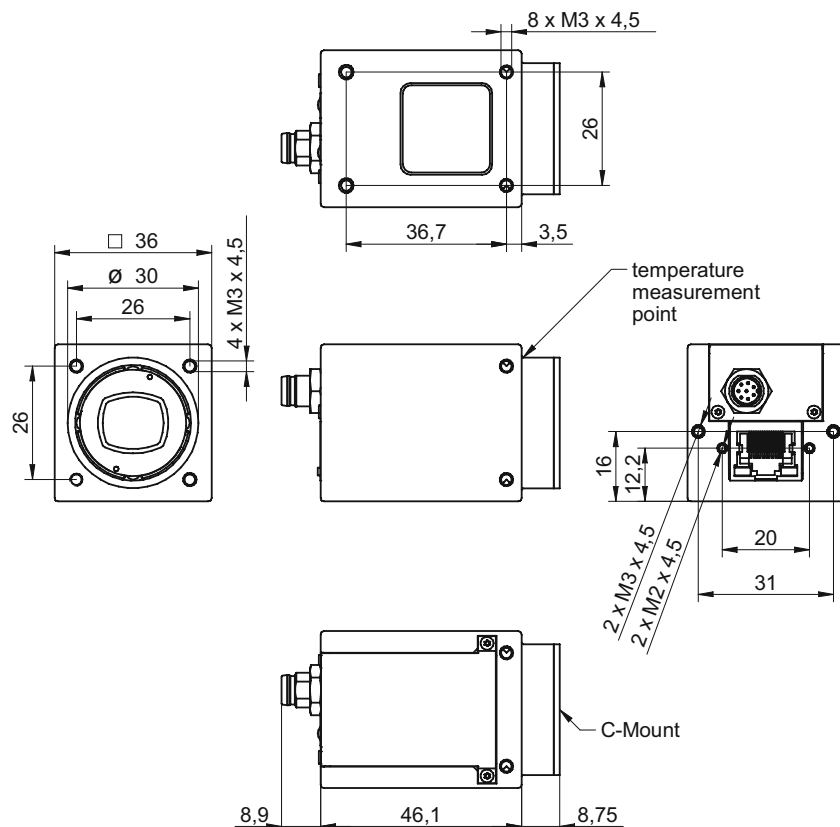

3.3 VCXG.I / .XT / .PTP

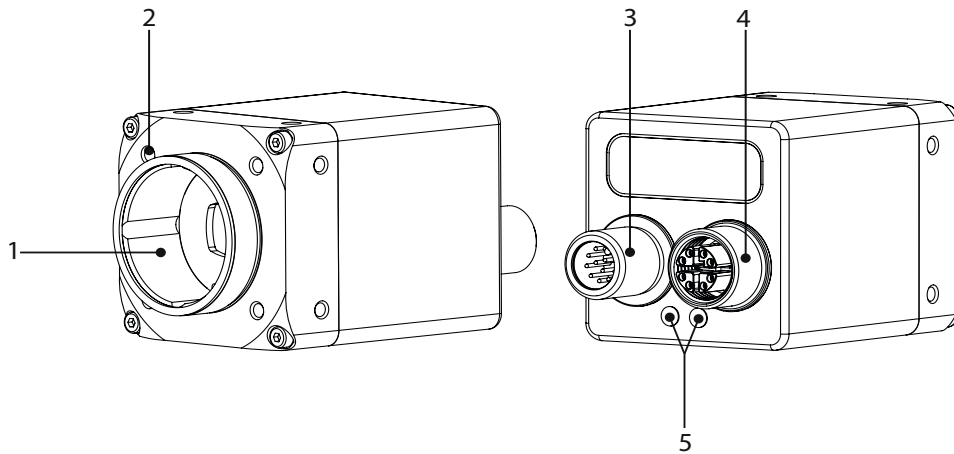

No.	Description	No.	Description
1	Lens mount (C-Mount)	4	Ethernet Port (PoE)
2	4 x Tube Adapter / front mounting threads	5	GigE Signaling LED's
3	Power supply / Digital-I/O		

Camera Type	Sensor Size	Resolution	Full Frames ¹⁾ [max. fps]
Monochrome / Color			
VCXG-13M.I / .XT / VCXG-13C.I / .XT	1/2"	1280 × 1024	145 94
VCXG-15M.I / .XT / VCXG-15C.I / .XT	1/2.9"	1140 × 1080	121 79
VCXG-25M.I / .XT / VCXG-25C.I / .XT	2/3"	1920 × 1200	59 53
VCXG-32M.I / .XT / VCXG-32C.I / .XT	1/1.8"	2048 × 1536	55.5 39.5
VCXG-32M.I.PTP / VCXG-32C.I.PTP	1/1.8"	2048 × 1536	55.5 39.5
VCXG-51M.I / .XT / VCXG-51C.I / .XT	2/3"	2448 × 2048	35.5 23.5
VCXG-51M.I.PTP / VCXG-51C.I.PTP	2/3"	2448 × 2048	35.5 23.5
VCXG-53M.I / .XT / VCXG-53C.I / .XT	1"	2592 × 2048	28 23.5
VCXG-82M.I / .XT / VCXG-82C.I / .XT	2/3"	2848 × 2832	15 15
VCXG-124M.I / .XT / VCXG-124C.I / .XT	1.1"	4096 × 3000	15 10
VCXG-124M.I.PTP / VCXG-124C.I.PTP	1.1"	4096 × 3000	15 10
VCXG-127M.I / .XT / VCXG-127C.I.XT	1/1.1"	4096 × 2992	10 10
VCXG-201M.R.I / .XT / VCXG-201C.R.I / .XT	1"	5472 × 3648	6 9
VCXG-241M.I / .XT / VCXG-241C.I / .XT	1.2"	5312 × 4592	5 5

¹⁾Burst Mode (image acquisition in the camera's internal memory) | interface

Dimensions

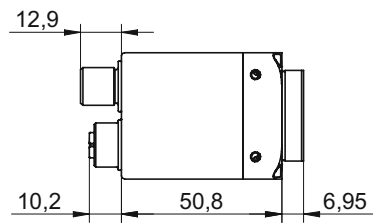
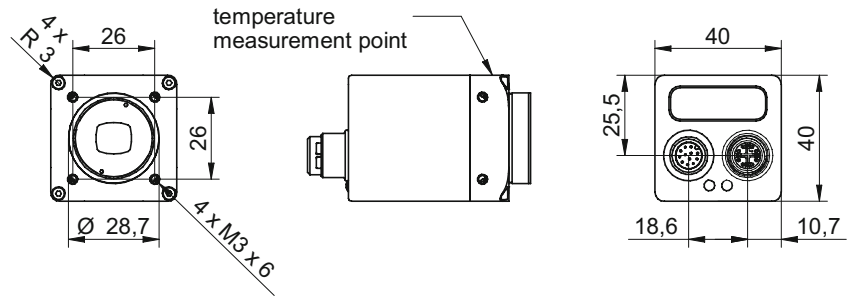
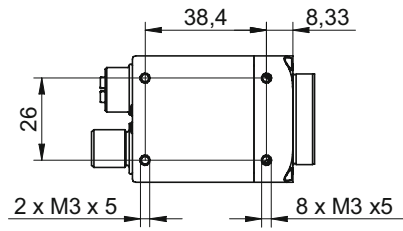

Modular tube system (ordered separately)

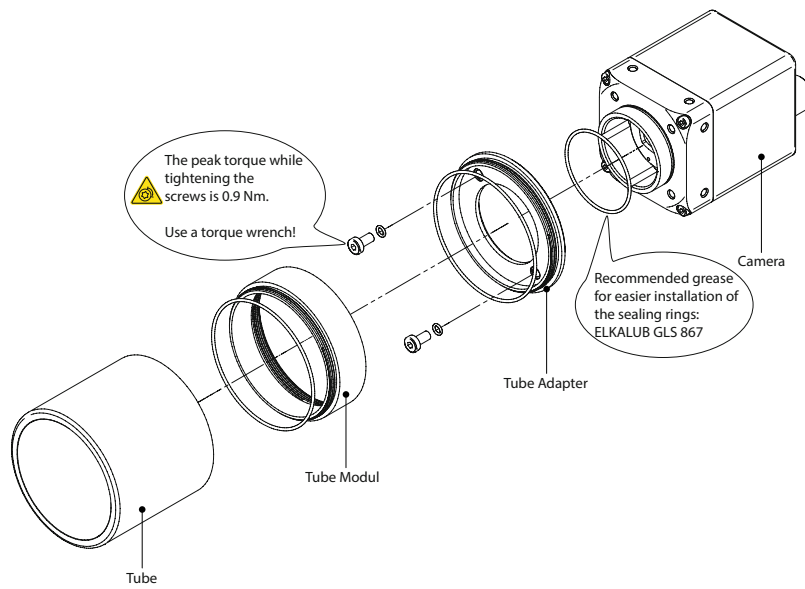

Tube Adapter

M 47

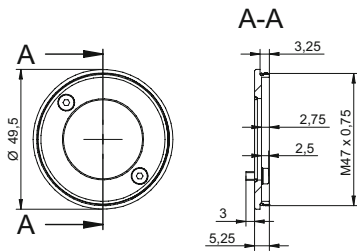

Art. No.: 11185373

M 62

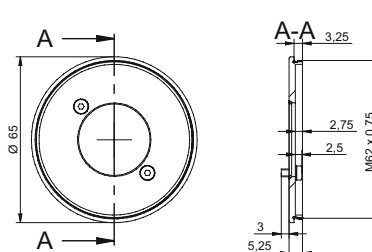

Art. No.: 11185377

M 92

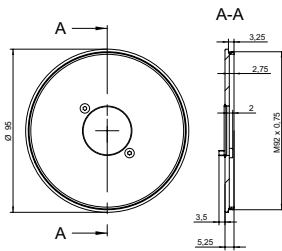

Art. No.: 11704311

Distance Ring

M 47

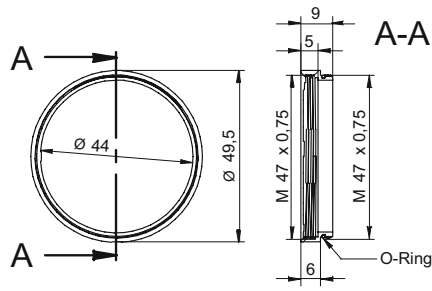

Art. No.: 11185372

M 62

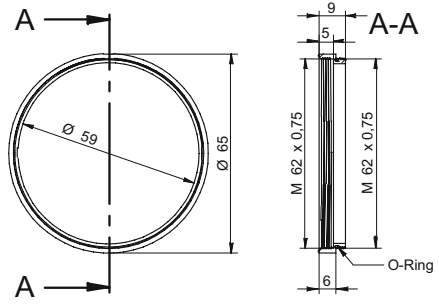

Art. No.: 11185376

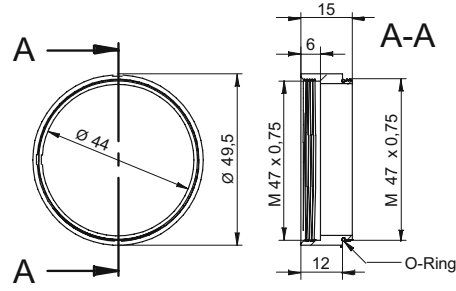

Art. No.: 11185371

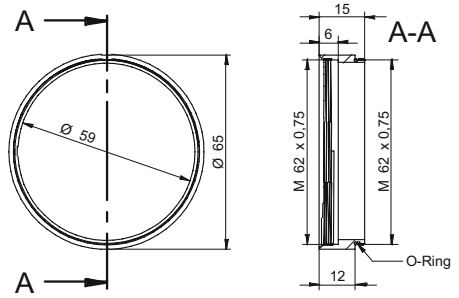

Art. No.: 11185375

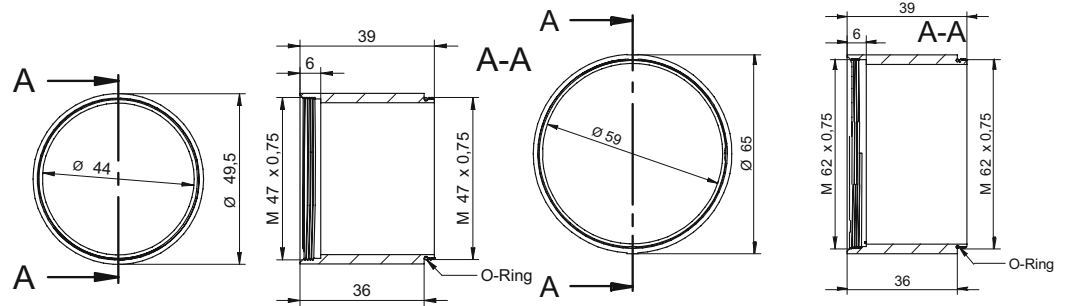

Art. No.: 11211571

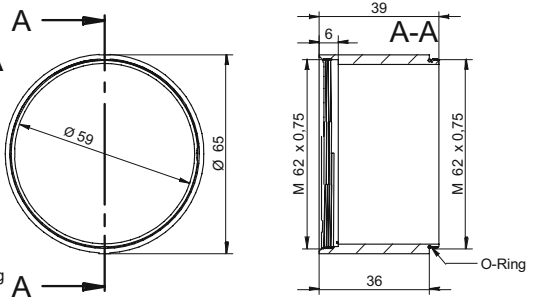

Art. No.: 11198906

M 92

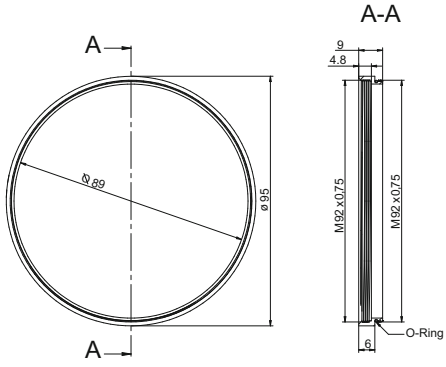

Art. No.: 11704395

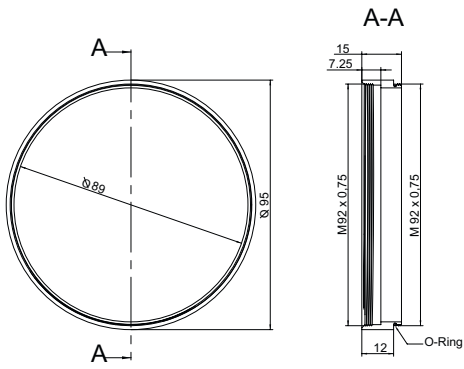

Art. No.: 11704397

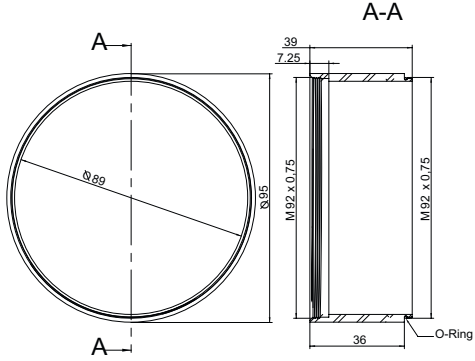

Art. No.: 11704394

Tube

M 47

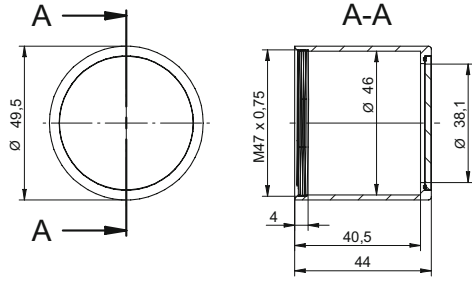

Art. No.: 11185370 (Cover Glass: Acryl)

Art. No.: 11195425 (Cover Glass: resistant laminated safety cover glass)

M 62

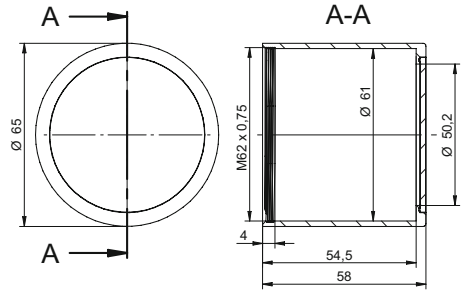

Art. No.: 11185374 (Cover Glass: Acryl)

Art. No.: 11195426 (Cover Glass: resistant laminated safety cover glass)

M 92

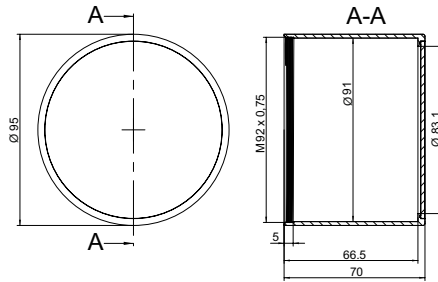

Art. No.: 11704312 / Cover glass: PMMA (Acryl)

Inner dimensions of the Tube

M 47

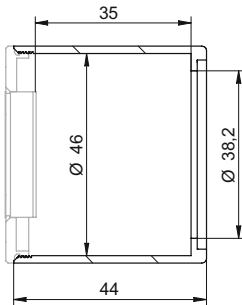

M 62

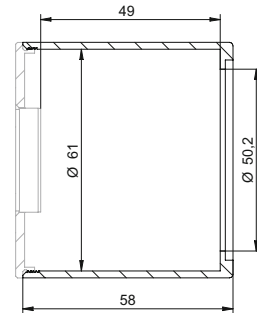

M 92

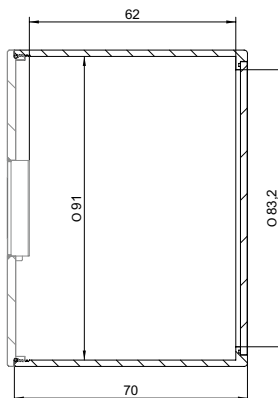

3.4 VCXU

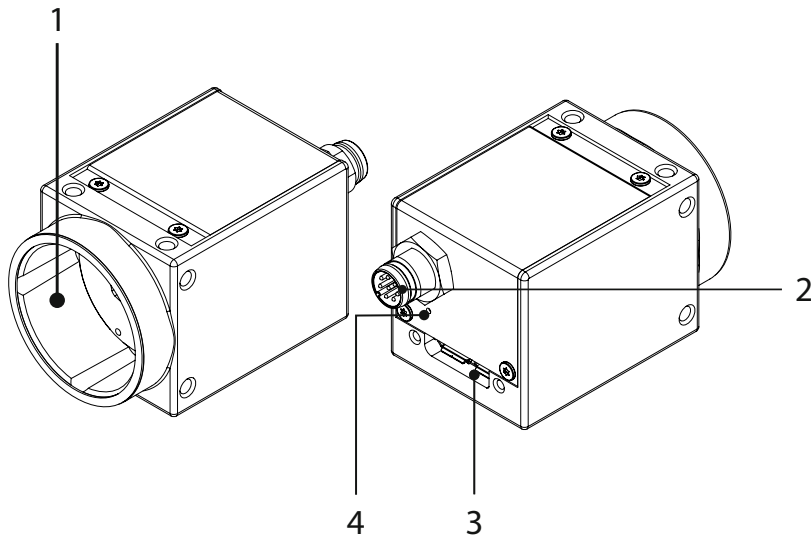

No.	Description	No.	Description
1	Lens mount (C-Mount)	3	USB 3.0 port
2	Digital-I/O	4	Signaling-LED

Camera Type	Sensor Size	Resolution	Full Frames [max. fps]
Monochrome / Color			
VCXU-02M / VCXU-02C	1/4"	640 × 480	891
VCXU-04M / VCXU-04C	1/2.9"	720 × 540	430
VCXU-13M / VCXU-13C	1/2"	1280 × 1024	222
VCXU-15M / VCXU-15C	1/2.9"	1440 × 1080	225
VCXU-22M.R / VCXU-22C.R	1/2"	1920 × 1080	138
VCXU-23M / VCXU-23C	1/1.2"	1920 × 1200	165
VCXU-24M / VCXU-24C	1/1.2"	1920 × 1200	38
VCXU-25M / VCXU-25C	2/3"	1920 × 1200	167
VCXU-31M / VCXU-31C	1/1.8"	2048 × 1536	120
VCXU-32M / VCXU-32C	1/1.8"	2048 × 1536	55.5
VCXU-50M / VCXU-50C	2/3"	2448 × 2048	73
VCXU-50MP	2/3"	2448 × 2048	73
VCXU-51M / VCXU-51C	2/3"	2448 × 2048	35
VCXU-53M / VCXU-53C	1"	2592 × 2048	73.5
VCXU-65M.R / VCXU-65C.R	1/1.8"	3072 × 2048	47
VCXU-90M / VCXU-90C	1"	4096 × 2160	41
VCXU-91M / VCXU-91C	1"	4096 × 2160	32
VCXU-123M / VCXU-123C	1.1"	4096 × 3000	31
VCXU-124M / VCXU-124C	1.1"	4096 × 3000	29
VCXU-125M.R / VCXU-125C.R	1/1.9"	4000 × 3000	29
VCXU-201M.R / VCXU-201C.R	1"	5472 × 3648	15

Dimensions

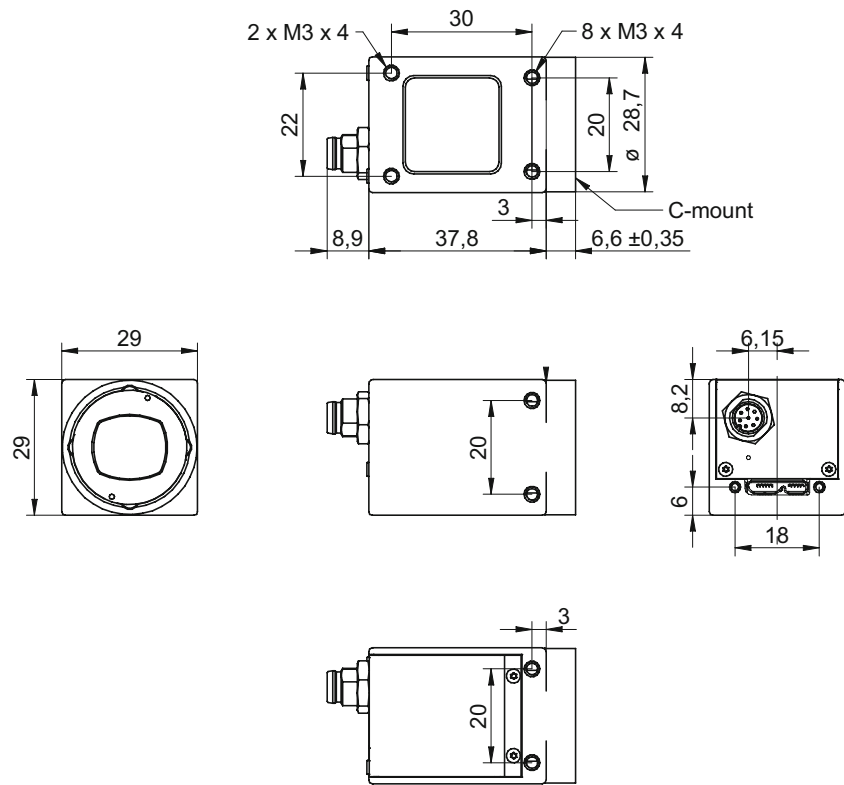

3.5 VCXU.XC

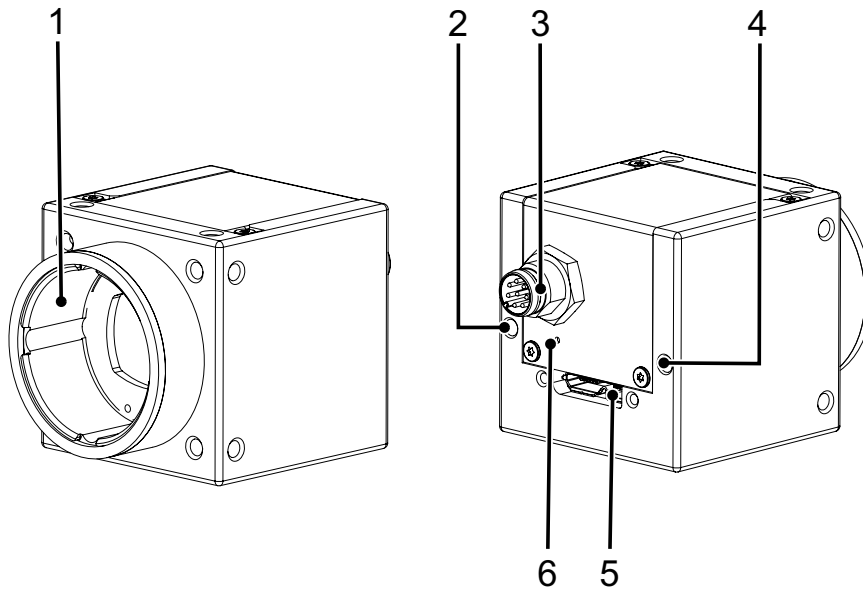

No.	Description	No.	Description
1	Lens mount (C-Mount)	4	Cooling pipe outlet
2	Cooling pipe intake	5	USB 3.0
3	Digital-I/O	6	LED

Camera Type	Sensor Size	Resolution	Full Frames [max. fps]
Monochrome			
VCXU-25M.XC	2/3"	1920 × 1200	167

Dimensions

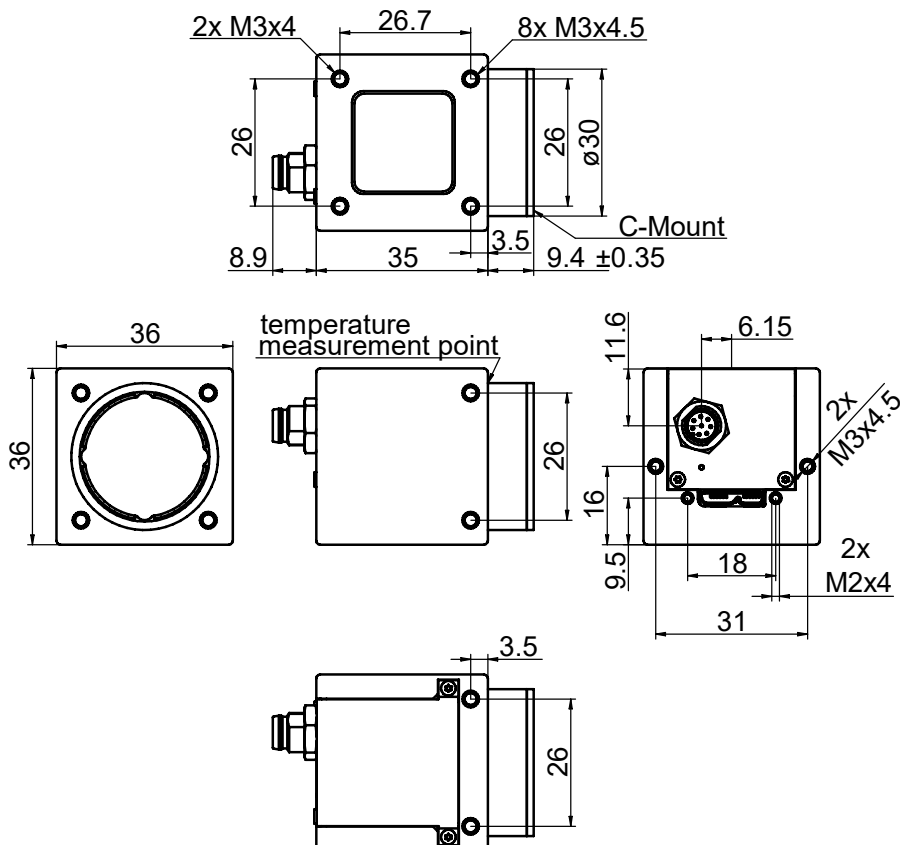

4. Installation

4.1 Environmental Requirements

Storage temperature	VCXG	-20 °C (-4 °F) ... +70 °C (+158 °F)
	VCXG.XC	-20 °C (-4 °F) ... +70 °C (+158 °F)
	VCXU	-20 °C (-4 °F) ... +70 °C (+158 °F)
	VCXU.XC	-20 °C (-4 °F) ... +70 °C (+158 °F)
	VCXG.I	-20 °C (-4 °F) ... +70 °C (+158 °F)
	VCXG.I.PTP	-20 °C (-4 °F) ... +70 °C (+158 °F)
	VCXG.I.XT	-40 °C (-40 °F) / -30 °C ²⁾ (-22 °F) ... +70 °C (+158 °F)
Operating temperature	VCXG	0 °C (32 °F) ... 60 °C (140 °F) ¹⁾ */** / 65 °C (149 °F)*/**
	VCXG.XC	0 °C (32 °F) ... 65 °C (149 °F) */** / 75 °C (167 °F)*/**
	VCXU	0 °C (32 °F) ... 60 °C (140 °F) ¹⁾ */** / 65 °C (149 °F)*/**
	VCXU.XC	0 °C (32 °F) ... 65 °C (149 °F) */** / 75 °C (167 °F)*/**
	VCXG.I	0 °C (32 °F) ... 65 °C (149 °F)*/**
	VCXG.I.PTP	0 °C (32 °F) ... 65 °C (149 °F)*/**
	VCXG.I.XT	-40 °C (-40 °F) / -30 °C ²⁾ (-22 °F) ... 70 °C (158 °F)*/**
Humidity	10 % ... 90 % non condensing	

¹⁾ VCXU-125M.R / C.R; VCXU-201M.R / C.R

²⁾ VCXG-201M.R.I.XT / C.R.I.XT

The sensor specification ensures unrestricted use from an operating temperature greater than -10 °C (14 °F). Use at temperatures lower than -10 °C (14 °F) may result in disturbed image acquisition or poorer image quality.

*/ at T (Measurement Point)

/** Ambient temperature in the range above 28 °C (82.4 °F) / 34 °C (93.2 °F) / 32 °C (89.6 °F) / 39 °C (102.2 °F) (depending on camera model) requires heat dissipation measures.

/*** Ambient temperature above 45 °C (113 °F) requires heat dissipation measures.

Notice

Ambient temperature for UL applications

The maximum ambient temperature (all cameras) for UL applications is 40 °C (104 °F). Air flow (1 m/s) required in all temperature ranges.

4.2 Heat Transmission

Notice
The values for MTBF can be found in the respective Technical Data Sheet (TDS).

⚠ Caution

 Device heats up during operation.
Skin irritation possible.
Do not touch the camera during operation.

⚠ Caution

Heat can damage the camera. Provide adequate dissipation of heat, to ensure that the temperatures does not exceed the value (see table below).

As there are numerous possibilities for installation, Baumer recommends no specific method for proper heat dissipation, but suggest the following principles:



- operate the cameras only in mounted condition
- mounting in combination with forced convection may provide proper heat dissipation

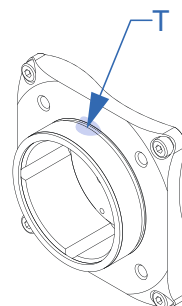
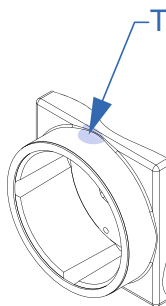

Temperature Measuring Point (T) Maximal Temperature			
VCXG / .XC / .R / .PTP	VCXU / .XC	VCXG.I / .PTP	VCXG.I.XT
65 °C (149 °F)	65 °C (149 °F) 60 °C (140 °F) ¹⁾	65 °C (149 °F)	70 °C (158 °F)

¹⁾ VCXU-125M.R/C.R; VCXU-201M.R/C.R

Cooling pipe (VCXG.XC / VCXU.XC only)

The camera is equipped with an internal cooling pipe integrated into the housing. Compressed air / Tempering liquid can be passed through this cooling pipe to cool the camera.

For connecting the compressed air / Tempering liquid hoses (Cooling pipe intake / Cooling pipe outlet) use push-in fittings with male thread M3 and plastic tubing for compressed air or Tempering liquid, e.g. FESTO QSM-M3-3-I and FESTO PUN-H-3x0.5.

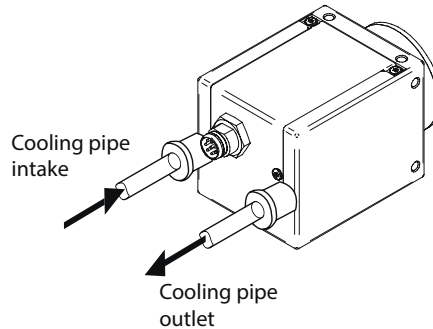

Cooling with air

Camera is tested with compressed air at 3 bar pressure according to ISO 8573-1:2010 [1:4:2] [Particles:Water:Oil] A maximum pressure of 6 bar is permissible.

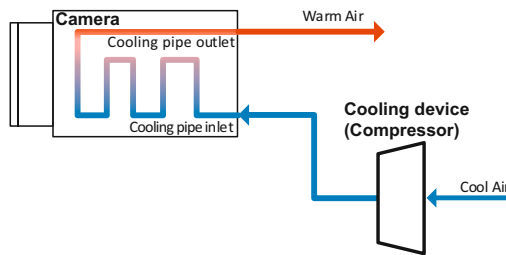

ISO 8573-12010 Compressed Air Contaminants and Purity Classes

Class	Particles				Water			Oil
	By Particle Size (maximum number of particles per m ³)			By Mass	Vapor Dewpoint	Pressure	Liquid	Liquid, Aerosol & Vapor
	0.10 - 0.5 microns	0.5 - 1.0 microns	1.0 - 5.0 microns	mg/m ³	°C	°F	g/m ³	mg/m ³
0	As specified by the equipment user or supplier and more stringent than class 1							
1	≤ 20,000	≤ 400	≤ 10	-	≤ -70	≤ -94	-	≤ 0.01
2	≤ 400,000	≤ 6,000	≤ 100	-	≤ -40	≤ -40	-	≤ 0.1
3	-	≤ 90,000	≤ 1,000	-	≤ -20	≤ -4	-	≤ 1
4	-	-	≤ 10,000	-	≤ +3	≤ +37	-	-
5	-	-	≤ 100,000	-	≤ +7	≤ +45	-	-
6	-	-	-	0 - ≤ 5	≤ +10	≤ +50	-	-
7	-	-	-	5 - ≤ 10	-	-	≤ 0.5	-
8	-	-	-	-	-	-	≤ 5	-
9	-	-	-	-	-	-	≤ 10	-
X	-	-	-	> 10	-	-	> 10	> 5

Comparison of temperature behavior without and with air cooling:

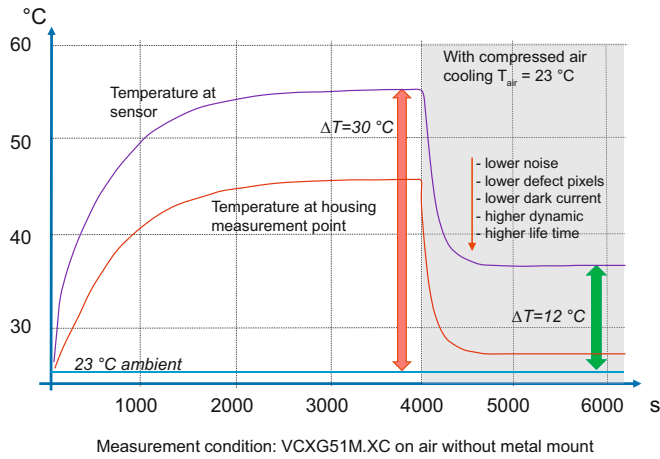

Cooling with tempering liquid

The cooling with liquid efficiently transports heat from the camera.

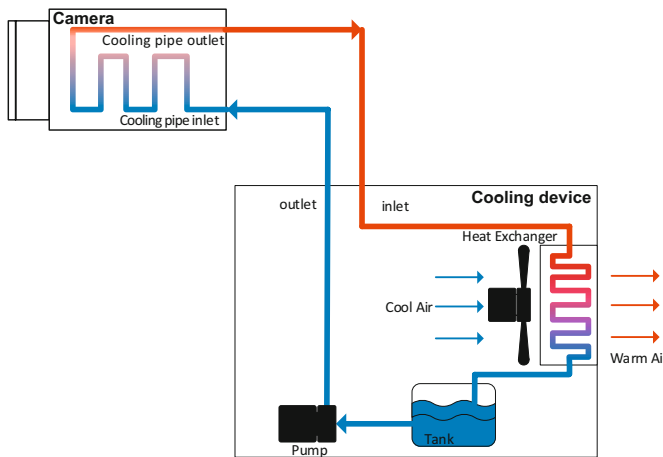

Danger!

Danger due to incorrect system components.

 Risk of electric shock. Electric shock can be fatal or cause serious injury.

The system components, cables, connections for tempering liquid, hoses for tempering liquid and the objective must be selected according to the operating conditions.

An ambient temperature of +85 °C (185 °F) must not be exceeded for the camera and its components, as the connectors (RJ45 and M8) are specified up to this temperature. At temperatures below freezing, make sure that the tempering liquid supply is not interrupted.

The tempering liquid must meet the following criteria:

- compatible with aluminum
- must contain bio-growth inhibitors
- must contain corrosion protection
- maximum pressure 6 bar
- Temperature range of liquid is recommended between: 1 .. 50 °C (depending on the ambient temperature)
- The camera was tested with a flow rate of 0,9l / h. The flow rate depends on the pump capacity used.

We recommend the water bath protective media "Aqua Stabil" from Julabo.

4.2.1 Emergency shutdown at critical Temperatures (\geq Rel. 2 only)

To prevent damage on the hardware due to high/low temperatures, the camera is equipped with an emergency shutdown. The *DeviceTemperatureStatusTransitionSelector* (Category: *Device Control*) feature allows you to select different thresholds for temperatures:

NormalToHigh: freely programmable value

HighToExceeded: fixed value (camera shutdown if exceeded)

ExceededToNormal: freely programmable value, temperature for error-free re-activation of the camera.

NormalToUnderrun (.I / SWIR models): fixed value (camera shutdown if value falls below, or camera does not start image acquisition)

In the *DeviceTemperatureStatusTransition* feature, the temperatures for the programmable temperature transitions are set.

The Event *DeviceTemperatureStatusChanged* is always generated when *DeviceTemperatureStatus* changes.

If the temperature rises above the value set at *HighToExceeded*, the *DeviceTemperatureExceeded* feature is set to *True*, the image recording is stopped, and the LED is set to red.

If the temperature falls below the *NormalToUnderrun* value, the *DeviceTemperatureUnderrun* function is set to *True*, image recording is stopped and the LED lights up red.

For further use, the camera must be disconnected from the power supply after cooling down or heating a device reset should be carried out.

The sufficient cooling / heating is recognizable when the event *DeviceTemperatureStatusChanged* (Device Temperature < *ExceededToNormal*) / (Device Temperature > *NormalToUnderrun*) is output.

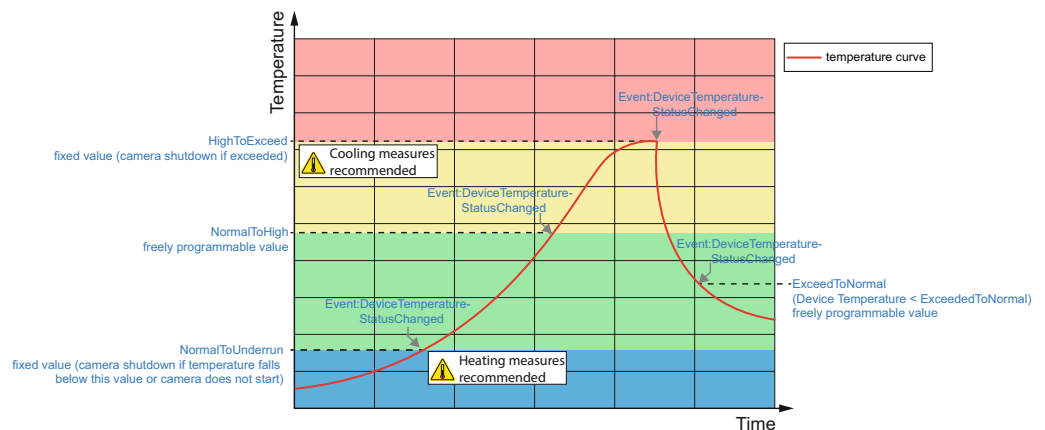

Temperatures for emergency shutdown

When the temperature measurement at the internal temperature sensor gives a temperature exceeding the specified values in the following tables, the *DeviceTemperatureExceeded* feature is set to *True*, the image recording is stopped, and the LED is set to red.

VCXG

Camera Type	max. Temperature (internal temperature sensor)
Monochrome / Color	
VCXG-02M / VCXG-02C	75 °C (167 °F)
VCXG-04M / VCXG-04C	75 °C (167 °F)
VCXG-13M / VCXG-13C	75 °C (167 °F)
VCXG-13NIR	75 °C (167 °F)
VCXG-15M / VCXG-15C	75 °C (167 °F)
VCXG-22M.R / VCXG-22C.R	72 °C (161.6 °F)
VCXG-23M / VCXG-23C	72 °C (161.6 °F)
VCXG-24M / VCXG-24C	72 °C (161.6 °F)
VCXG-25M / VCXG-25C	75 °C (167 °F)
VCXG-32M / VCXG-32C	72 °C (161.6 °F)
VCXG-50MP	75 °C (167 °F)
VCXG-51M / VCXG-51C	75 °C (167 °F)
VCXG-53M / VCXG-53C	75 °C (167 °F)
VCXG-53NIR	75 °C (167 °F)
VCXG-65M.R / VCXG-65C.R	72 °C (163.4 °F)
VCXG-82M / VCXG-82C	75 °C (167 °F)
VCXG-91M / VCXG-91C	75 °C (167 °F)
VCXG-124M / VCXG-124C	75 °C (167 °F)
VCXG-125M.R / VCXG-125C.R	75 °C (167 °F)
VCXG-127M / VCXG-127C	75 °C (167 °F)
VCXG-201M.R / VCXG-201C.R	75 °C (167 °F)
VCXG-204M / VCXG-204C	75 °C (167 °F)
VCXG-241M / VCXG-241C	75 °C (167 °F)

VCXG.PTP

Camera Type	max. Temperature (internal temperature sensor)
Monochrome / Color	
VCXG-32M.PTP / VCXG-32C.PTP	70 °C (158 °F)
VCXG-51M.PTP / VCXG-51C.PTP	70 °C (158 °F)
VCXG-124M.PTP / VCXG-124C.PTP	70 °C (158 °F)

VCXG.I

Camera Type	max. Temperature (internal temperature sensor)
Monochrome / Color	
VCXG-13M.I / VCXG-13C.I	70 °C (158 °F)
VCXG-15M.I / VCXG-15C.I	70 °C (158 °F)
VCXG-25M.I / VCXG-25C.I	70 °C (158 °F)
VCXG-32M.I / VCXG-32C.I	70 °C (158 °F)
VCXG-51M.I / VCXG-51C.I	70 °C (158 °F)
VCXG-53M.I / VCXG-53C.I	70 °C (158 °F)
VCXG-82M.I / VCXG-82C.I	75 °C (167 °F)
VCXG-124M.I / VCXG-124C.I	70 °C (158 °F)
VCXG-127M.I / VCXG-127C.I	75 °C (167 °F)
VCXG-201M.R.I / VCXG-201C.R.I	75 °C (167 °F)
VCXG-241M.I / VCXG-241C.I	75 °C (167 °F)

VCXG.I.PTP

Camera Type	max. Temperature (internal temperature sensor)
Monochrome / Color	
VCXG-32M.I.PTP / VCXG-32C.I.PTP	70 °C (158 °F)
VCXG-51M.I.PTP / VCXG-51C.I.PTP	70 °C (158 °F)
VCXG-124M.I.PTP / VCXG-124C.I.PTP	70 °C (158 °F)

VCXG.I.XT

Camera Type	max. Temperature (internal temperature sensor)
Monochrome / Color	
VCXG-13M.I.XT / VCXG-13C.I.XT	75 °C (167 °F)
VCXG-15M.I.XT / VCXG-15C.I.XT	75 °C (167 °F)
VCXG-25M.I.XT / VCXG-25C.I.XT	75 °C (167 °F)
VCXG-32M.I.XT / VCXG-32C.I.XT	75 °C (167 °F)
VCXG-51M.I.XT / VCXG-51C.I.XT	75 °C (167 °F)
VCXG-53M.I.XT / VCXG-53C.I.XT	75 °C (167 °F)
VCXG-82M.I.XT / VCXG-82C.I.XT	75 °C (167 °F)
VCXG-124M.I.XT / VCXG-124C.I.XT	75 °C (167 °F)
VCXG-127M.I.XT / VCXG-127C.I.XT	75 °C (167 °F)
VCXG-201M.R.I.XT / VCXG-201C.R.I.XT	75 °C (167 °F)
VCXG-241M.R.I.XT / VCXG-241C.R.I.XT	75 °C (167 °F)

VCXG.XC

Camera Type	max. Temperature (internal temperature sensor)
Monochrome / Color	
VCXG-03SWIR.XC	75 °C (167 °F)
VCXG-14SWIR.XC	75 °C (167 °F)
VCXG-51M.XC	70 °C (158 °F)

VCXU

Camera Type	max. Temperature (internal temperature sensor)
Monochrome / Color	
VCXU-02M / VCXU-02C	75 °C (167 °F)
VCXU-04M / VCXU-04C	72 °C (161.6 °F)
VCXU-13M / VCXU-13C	75 °C (167 °F)
VCXU-15M / VCXU-15C	72 °C (161.6 °F)
VCXU-23M / VCXU-23C	72 °C (161.6 °F)
VCXU-22M.R / VCXU-22C.R	72 °C (161.6 °F)
VCXU-24M / VCXU-24C	72 °C (161.6 °F)
VCXU-25M / VCXU-25C	75 °C (167 °F)
VCXU-31M / VCXU-31C	72 °C (161.6 °F)
VCXU-32M / VCXU-32C	72 °C (161.6 °F)
VCXU-50M / VCXU-50C	72 °C (161.6 °F)
VCXU-51M / VCXU-51C	72 °C (161.6 °F)
VCXU-50MP	72 °C (161.6 °F)
VCXU-53M / VCXU-53C	75 °C (167 °F)
VCXU-65M.R / VCXU-65C.R	73 °C (163.4 °F)
VCXU-90M / VCXU-90C	72 °C (161.6 °F)
VCXU-91M / VCXU-91C	72 °C (161.6 °F)
VCXU-123M / VCXU-123C	72 °C (161.6 °F)
VCXU-124M / VCXU-124C	72 °C (161.6 °F)
VCXU-125M.R / VCXU-125C.R	75 °C (167 °F)
VCXU-201M.R / VCXU-201C.R	75 °C (167 °F)

VCXU.XC

Camera Type	max. Temperature (internal temperature sensor)
Monochrome	
VCXU-25M.XC	75 °C (167 °F)

4.3 Lens mounting

Notice

Avoid contamination of the sensor and the lens by dust and airborne particles when mounting the lens to the device!

Therefore the following points are very important:

- Install the camera in an environment that is as dust free as possible!
- Keep the dust cover (bag) on camera as long as possible!
- Hold the camera downwards with unprotected sensor.
- Avoid contact with any optical surface of the camera!

4.4 IP Protection classes (VCXG.I / .I.XT)

Notice

Definition IP65 / IP67

IP65 says that the camera housing is dust tight and hose-proof. That means it is protected against water jet that is projected by a nozzle striking the housing from any direction.

IP67 stands for dust tightness besides the protection against submersion into 1 meter deep water for up to 30 minutes. The desired protection level is given as long as the difference in temperature between camera and water is less than 5 K and the water has a temperature of 15 °C (+ 59 °F) ... 35 °C (+ 95 °F).

Notice

The IP Protection classes for VCXG, VCXU, VCXG.XC and VCXU.XC was not evaluated by UL.

⚠ Caution

In order to achieve the mentioned IP protection level, please note the following information:



The tube needs to be screwed on gap-free as shown in the figure below.

The M12 connectors need to be tightened with a torque value of 0.4 Nm.

For that Baumer suggests the use of a torque driver (such as Wiha TorqueVario®-S ESD) in combination with a wrench for assembling sensor/actuator cables with M12 connector (such as Phoenix Contact SAC BIT M12-D15).

Sealing rings

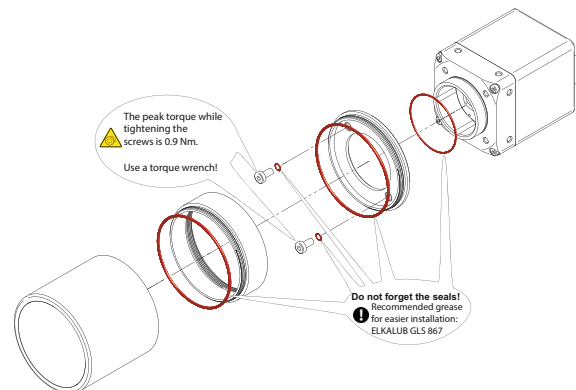

Gap-free assembly

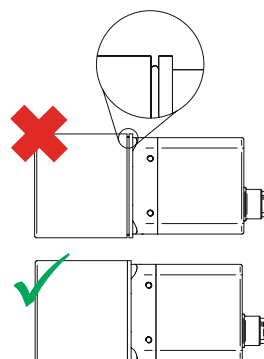

4.5 Filter replacement

A filter is installed in color cameras. This filter can lead to limitations in the applicability of the sensor for specific applications.

Proceed as follows to replace the filter.

Notice

Avoid contamination of the filter, sensor and the lens by dust and airborne particles!

Perform the filter replacement in a dust-free room with clean tools!

Procedure

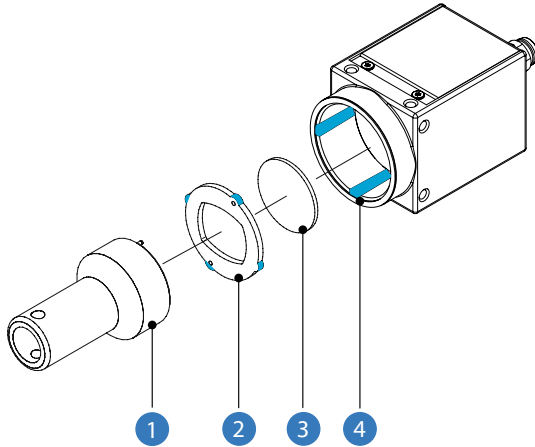

1. Insert the assembly tool (1) into the sensor opening. Place the two pins at the front end into the locator holes of the filter holder (2).
2. Turn the filter holder (2) until the guide tabs can be seen in the guide grooves (4).
3. Remove the filter holder (2).
4. Carefully remove the existing filter (3). Do not touch the sensor!
5. Insert the new filter into the sensor opening.
6. Put the filter holder (2) back in.
7. Turn the filter holder (2) until the guide tabs cannot be seen in the guide grooves (4).

4.6 Cable requirements for UL conformity

For UL conform installations the cables used must meet the following requirements:

- shielding for optimum electrical noise immunity
- IP protection class according to intended use
- UL approval
- dielectric strength according to the operating voltages used (min. 30 V)
- temperature stability in the specified device temperature range (min. 70 °C (158 °F))
- minimum cross section of cable suitable for max. output current

4.7 Cleaning

Due to its compact design, the device is characterized by almost maintenance-free operation.

When used for the intended purpose, it is possible that the device may need to be cleaned from time to time. Very clean optical surfaces (cover glass) are required for the consistent and reproducible operation of the device.

Housing

⚠ Caution!	
	<p>Volatile solvents for cleaning. Volatile solvents damage the surface of the camera. Never use volatile solvents (benzine, thinner) for cleaning!</p>

To clean the surface of the camera housing, use a soft, dry cloth. To remove persistent stains, use a soft cloth dampened with a small quantity of neutral detergent, then wipe dry.

Filter / Cover glass sensor

Notice	
	<p>The sensor is mounted dust-proof. Remove of the cover glass for cleaning is not necessary.</p>

Avoid cleaning the cover glass of the sensor if possible. To prevent dust, follow the instructions under "Install lens".

If you must clean it, use compressed air or a soft, lint free cloth dampened with a small quantity of pure alcohol.

Tube cover glass

For cleaning, use a soft, lint-free cloth to clean the surface of the tube cover glass with a gentle pressure, without scratching.

To clean stubborn dirt, commonly available window cleaning agent is recommended.

⚠ Caution!	
	<p>Ensure that no residues of the cleaning agent or scratches remain on the glass. These can permanently damage the reproducibility of the results from the device.</p>

⚠ Caution!	
	<p>As so many cleaning agents are available, we hope you understand that we cannot test every single one. Resistance to cleaning agents and areas of use depends upon the specific application. Cleaning agents must be tested on an discreet area of the device under application conditions to evaluate if they are suitable.</p>

4.8 Mechanical Tests

Environmental Testing	Standard	Parameter	
Vibration, sinusoidal	IEC 60068-2-6	Frequency Range	10 - 2000 Hz
		Amplitude underneath crossover frequencies	1.5 mm
		Acceleration	10 g
		Test duration / Axis	150 min
Vibration, broad band	IEC 60068-2-64	Frequency range	
		VCXG (.XC / .PTP) / VCXU (.XC)	20 - 1000 Hz
		VCXG.I (.PTP) / .XT	5 - 2000 Hz
		Acceleration RMS	10 g
		Test duration / Axis	300 min
Shock	IEC 60068-2-27	Puls time	11 ms / 6 ms
		Acceleration	50 g / 100 g
		Number of shocks per direction and axis	10
Bump	IEC60068-2-29	Pulse Time	2 ms
		Acceleration	100 g
		Number of bumps per direction and axis	5000

Vibrations

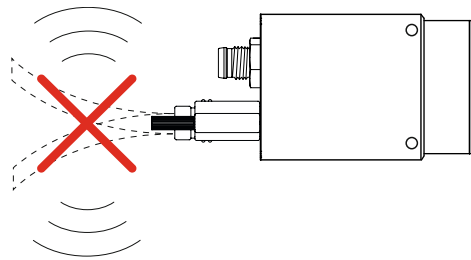

Caution!



Vibration that is not decoupled can damage the ports on the camera. Cables have to be fixed in a way that vibrations are not transmitted into the camera.

5. Pin-Assignment / LED-Signaling

Danger!

Use in wet environments requiring IP67 protection

Risk of electric shock. Electric shock can be fatal or cause serious injury.



Use is only permitted under consideration of pollution degree 2 and overvoltage category 2.

The M12 connectors must comply with the IEC 61076-2-101 standard.

The dielectric strength and withstand voltage for the plug/socket combination must be checked according to DIN EN 60664-1:2008-01 for 60 V.

Notice

Class 2 per NEC / Protection Class III

The device is intended to be supplied from an isolated Limited Energy Source per UL61010-1, 3rd ed cl. 9.4 or Limited Power Source per UL60950-1 or Class 2 per NEC.

Notice

The unit is to be connected only to internal Ethernet networks without exiting a facility and being subjected to Telecommunication Network Voltages (TNVs).

5.1 VCXG / .PTP / .XC

5.1.1 Ethernet Interface

Caution!

Power supply via PoE and digital IO connection

The camera (except VCXG-03SWIR.XC, VCXG-14SWIR.XC) supports power supply via PoE (Power over Ethernet) IEEE 802.3af Clause 33, 48V.



Parallel power supply via Ethernet interface and digital IO port is subject to deviations and tolerances. These might damage the camera.

Only use a single form of power supply!

8P8C Modular Jack (RJ45) with LEDs

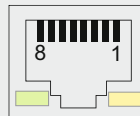

1	MX1+	5	MX3-
2	MX1-	6	MX2-
3	MX2+	7	MX4+
4	MX3+	8	MX4-

⚠ Caution!



The camera is equipped with a TYPE090 fixed connector. Using a Free Connector (cable) other than TYPE090 could damage the Fixed Connector.

Only use cables with a TYPE090 Free Connector.

"The TYPE090 connector is recommended for new designs."

(GigE Vision® Mechanical Supplement v1.0)

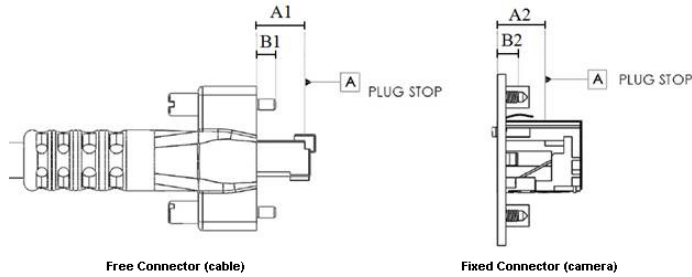

Dimension - Free Connector (cable)	TYPE090	TYPE110 Do not use!
From overmold to plug stop (A1)	9.0 mm (-0.50 + 0.00)	11.0 mm (-0.47 + 0.00)
From overmold to tip of thumbscrews (B1)	4.25 mm (-1.00 + 0.25)	4.25 mm (-1.00 + 0.25)

Dimension – Fixed Connector (camera)	TYPE090
From contact point to plug stop (A2)	9.0 mm (-0.00 + 1.00)
From contact point to bottom of thumb-screw thread (B2)	4.5 mm (-0.00 + 1)

5.1.2 Power Supply and IOs

Power Supply / Digital-IOs (on camera side)
wire colors of the connecting cable (ordered separately)

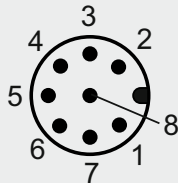

1	GPIO (Line2)	white	5	Power V _{CC} OUT1	grey
2	Power V _{CC}	brown	6	OUT1 (Line3)	pink
3	IN1 (Line0)	green	7	GND (Power, GPIO)	blue
4	GND IN1	yellow	8	GPIO (Line1)	red

Power Supply

Power V _{CC}	12 V ... 24 V (± 20 %) (Power consumption: max. 4.2 W)
-----------------------	--

5.1.3 GPIO (General Purpose Input/Output)

Lines 1 and 2 are GPIOs and can be inputs and outputs.

Used as an input: (0 ... 0.8 V low, 2.0 ... 3.0 V high).

Used as an output: (0 ... 0.4 V low, 2.4 ... 3.3 V high),
@ 1 mA load (high) / 50 mA sink (low)

⚠ Caution

The General Purpose IOs (GPIOs) are not potential-free and do not have an overrun cut-off. Incorrect wiring (overvoltage, undervoltage or voltage reversal) can lead to defects within the electronics system.



GPIO Power V_{CC} : 3.3 V DC
Load resistor for TTL-High-Level: approx. 2.7 k Ω

The GPIOs are configured as an input through the default camera settings. They must be connected to GPIO_GND if not used or not configured as an output. The configuration as output by default (stored in a user set) is possible with cameras \geq Release 3.

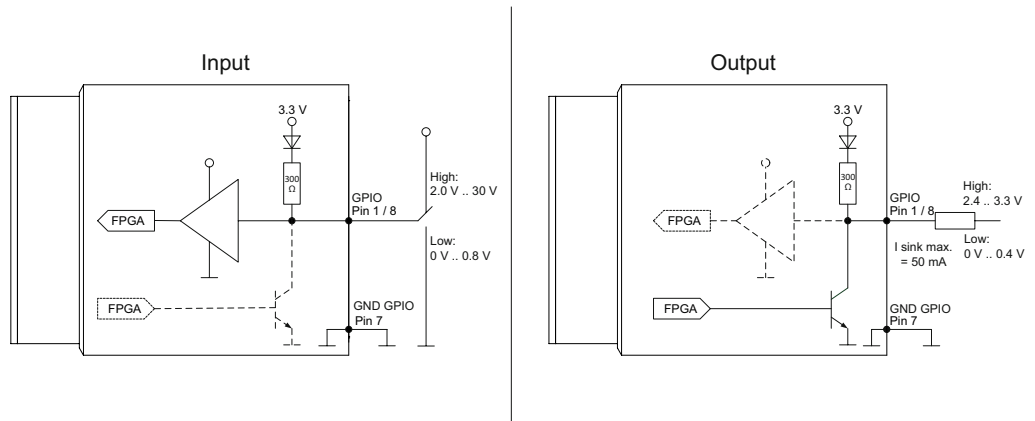

5.1.4 Digital-IO

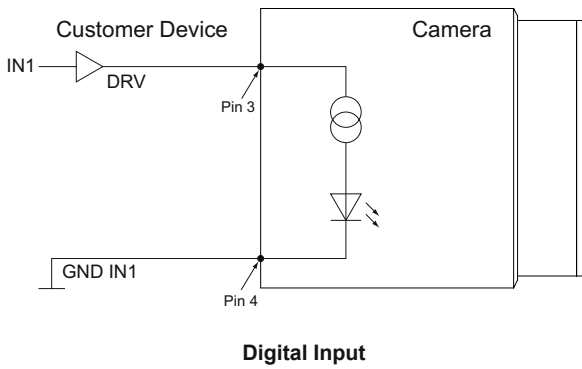
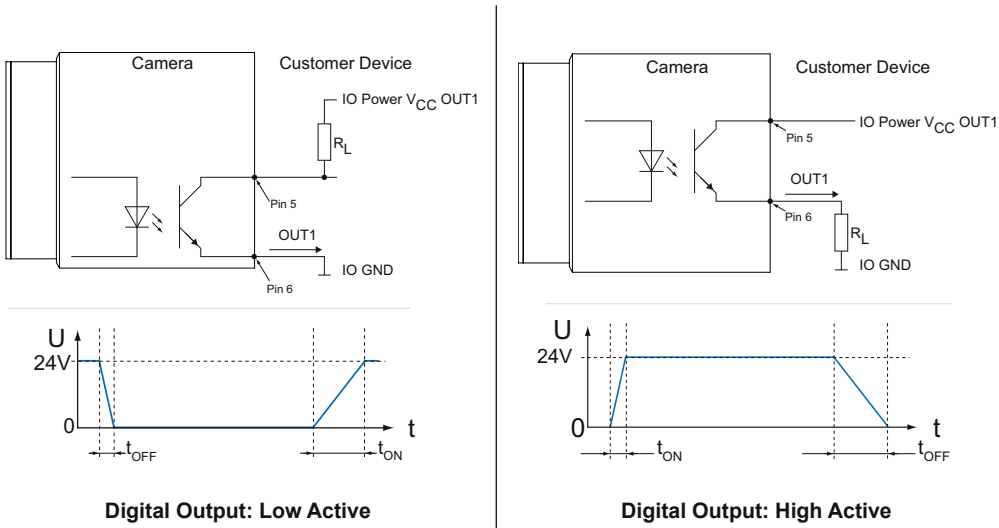

5.1.5 LED Signaling

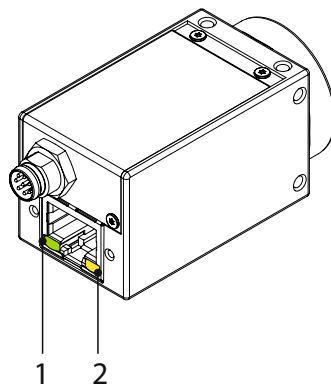

LED positions on Bau-mer VCXG cameras.

LED	Signal	Meaning
1	green static	link active
	green flash	receiving
2	yellow static	error
	yellow flash	transmitting

5.2 VCXG.I / .XT / .PTP

5.2.1 Ethernet Interface

⚠ Caution!

Power supply via PoE and digital IO connection
 The camera supports power supply via PoE (Power over Ethernet) IEEE 802.3af Clause 33, 48V.

 Parallel power supply via Ethernet interface and digital IO port is subject to deviations and tolerances. These might damage the camera.

Only use a single form of power supply!

⚠ Caution!

In order to achieve the mentioned IP protection level, the M12 connectors need to be tightened with a torque value of 0.4 Nm.

 For that Baumer suggests the use of a torque driver (such as Wiha TorqueVario®-S ESD) in combination with a wrench for assembling sensor/actuator cables with M12 connector (such as Phoenix Contact SAC BIT M12-D15).

Ethernet (SACC-CI-M12FS-8CON-L180-10G)

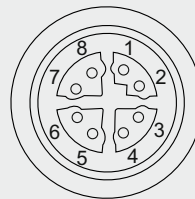

1	MX1+	5	MX4+
2	MX1-	6	MX4-
3	MX2+	7	MX3-
4	MX2-	8	MX3+

5.2.2 Power Supply and IOs

Power Supply / Digital-IOs (on camera side) (SACC-CI-M12MS-12CON-L180) wire colors of the connecting cable (ordered separately)



1	Power V_{CC}	brown	7	OUT3 (Line6)	black
2	GND (Power)	blue	8	IN3 (Line2)	grey
3	IN1 (Line0)	white	9	OUT4 (Line7)	red
4	OUT1 (Line4)	green	10	IN4 (Line3)	violet
5	IN2 (Line1)	pink	11	GND (IO)	grey-pink
6	OUT2 (Line5)	yellow	12	Power (IO)	red-blue

Power Supply

Power V_{CC}	12 V ... 24 V ($\pm 20\%$) (Power consumption: max. 4.6 W)
Power (IO)	<u>For UL conform installations:</u> 12 V (- 20 %) ... 24 V (+ 20 %) <u>For not UL conform installations:</u> 12 V (- 20 %) ... 48 V (+ 10 %)

5.2.3 Digital-IO

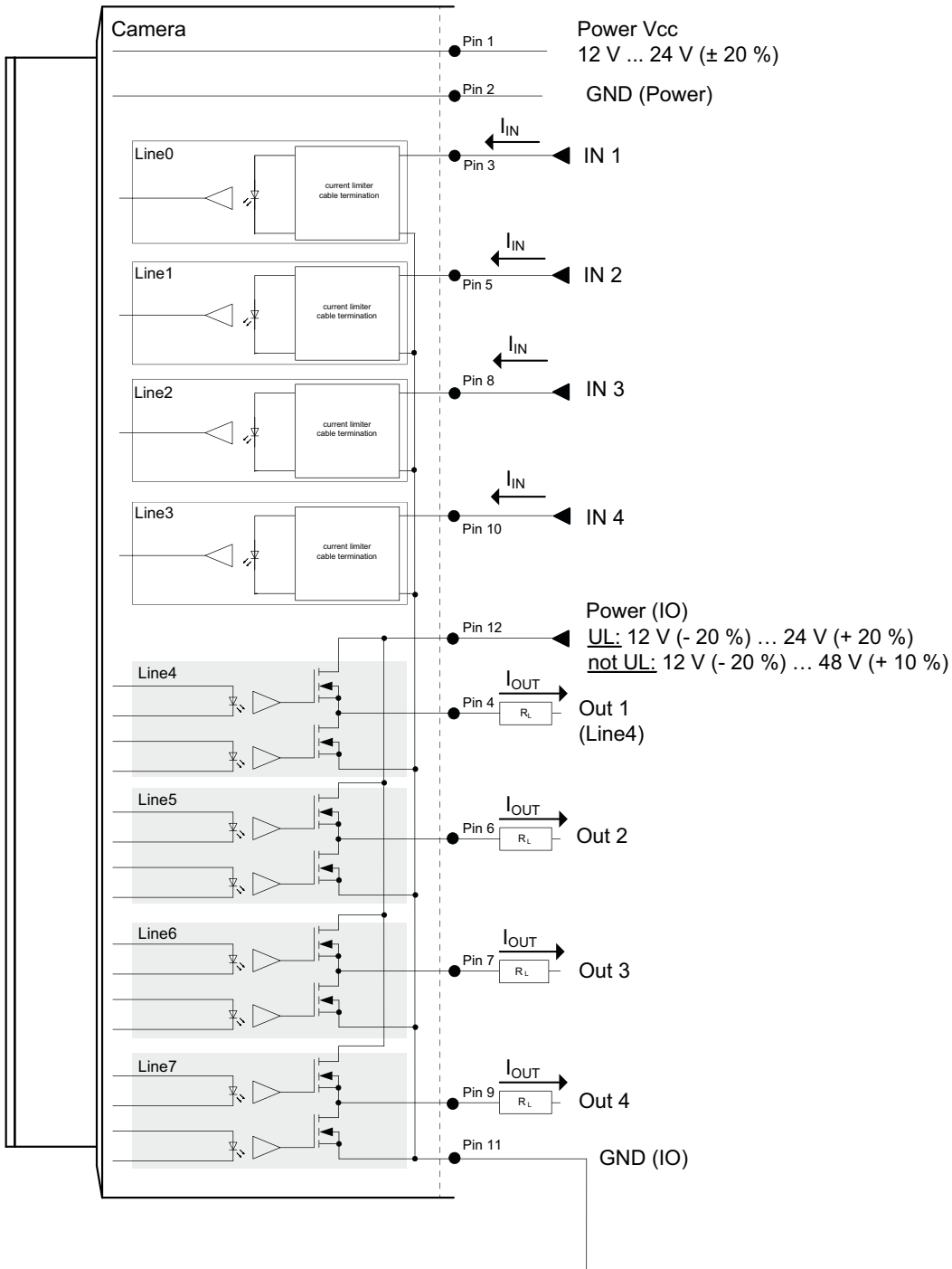

5.2.4 LED Signaling

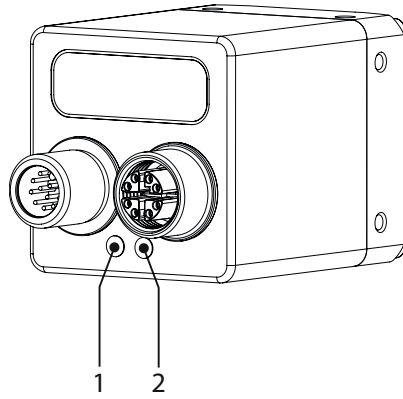

LED positions on Baumer VCXG.I / .XT cameras.

LED	Signal	Meaning
1	yellow static	error
	yellow flash	transmitting
2	green static	link active
	green flash	receiving

5.3 VCXU / .XC

5.3.1 USB 3.0 Interface

USB 3.0 Micro B



1	VBUS	6	MicB_SSTX-
2	D-	7	MicB_SSTX+
3	D+	8	GND_DRAIN
4	ID	9	MicB_SSRX-
5	GND	10	MicB_SSRX+

⚠ Caution

If the camera is connected to an USB2.0 port image transmission is disabled by default. The camera consumes more than 2.5W which is the maximum allowed by the USB2.0 specification. But there is a possibility to activate the image transmission at your own risk!

This activation could damage your computer's hardware!

Procedure



1. Open the camera in the *Camera Explorer*.
 2. Select the Profile *GenICam Guru*.
 3. Activate the Feature *USB2 Support Enable* in the category *Device Control*.
 4. Disconnect the data connection of the camera to the USB 2.0 port.
 5. Connect the data connection of the camera to the USB 2.0 port.
- Images will be transmitted via the USB 2.0 port.

5.3.2 Digital-I/Os

Power Supply / Digital-I/Os (on camera side) wire colors of the connecting cable (ordered separately)

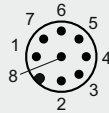

1	GPIO (Line2)	white	5	Power VCC OUT1	grey
2	not connected	brown	6	OUT1 (Line3)	pink
3	IN1 (Line0)	green	7	GND GPIO	blue
4	GND IN1	yellow	8	GPIO (Line1)	red

Power Supply

Power V _{CC}	5 V via USB, (Power consumption: max. 4 W)
-----------------------	--

5.3.3 GPIO (General Purpose Input/Output)

Lines 1 and 2 are GPIOs and can be inputs and outputs.

Used as an input: (0 ... 0.8 V low, 2.0 ... 3.0 V high).

Used as an output: (0 ... 0.4 V low, 2.4 ... 3.3 V high),
@ 1 mA load (high) / 50 mA sink (low)

⚠ Caution

The General Purpose IOs (GPIOs) are not potential-free and do not have an overrun cut-off. Incorrect wiring (overvoltage, undervoltage or voltage reversal) can lead to defects within the electronics system.

 GPIO Power V_{CC} : 3.3 V DC
Load resistor for TTL-High-Level: approx. 2.7 k Ω

The GPIOs are configured as an input through the default camera settings. They must be connected to GPIO_GND if not used or not configured as an output. The configuration as output by default (stored in a user set) is possible with cameras \geq Release 3.

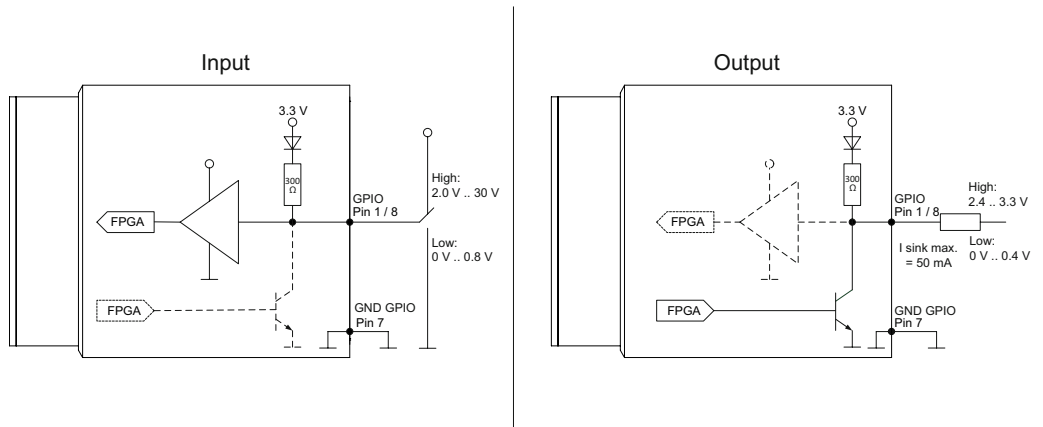

5.3.4 Digital-IO

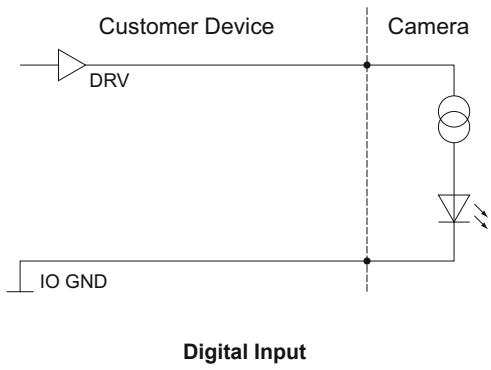
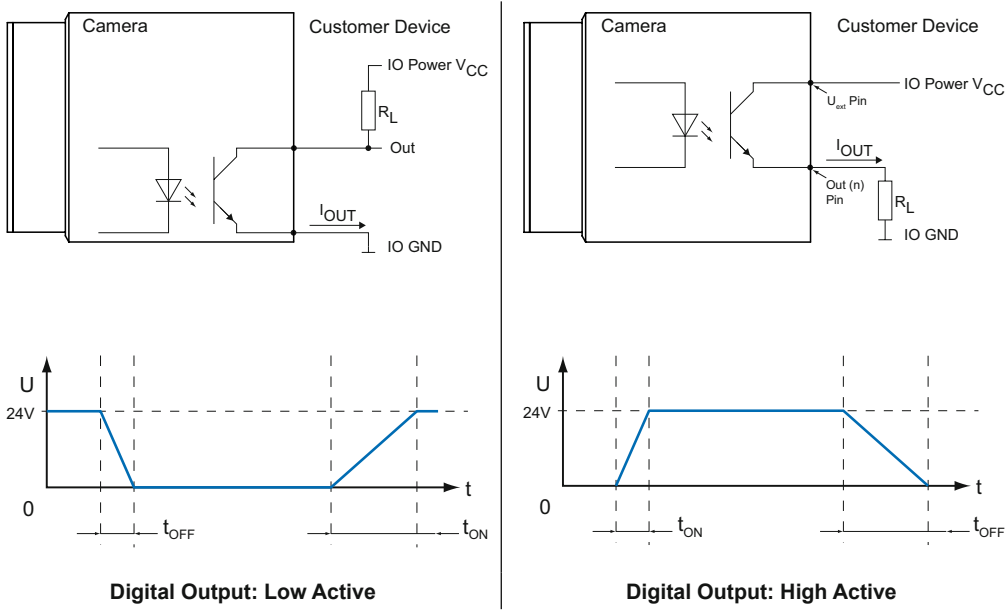

5.3.5 LED Signaling

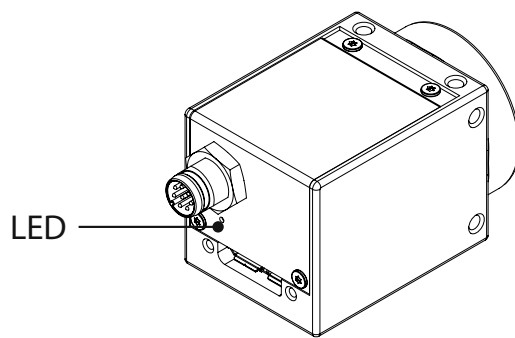

LED position on Baumer VCXU(.XC) camera.

	Signal	Meaning
LED	green flash	Power on
	green	USB 3.0 connection
	red	USB 2.0 connection
	yellow	Readout active
	red flash	Update

6. Product Specifications

6.1 Spectral Sensitivity

The spectral sensitivity characteristics of monochrome and color matrix sensors for cameras of this series are displayed in the following graphs. The characteristic curves for the sensors do not take the characteristics of lenses and light sources without filters into consideration.

Values relating to the respective technical data sheets.

Filter glasses / Cover glasses

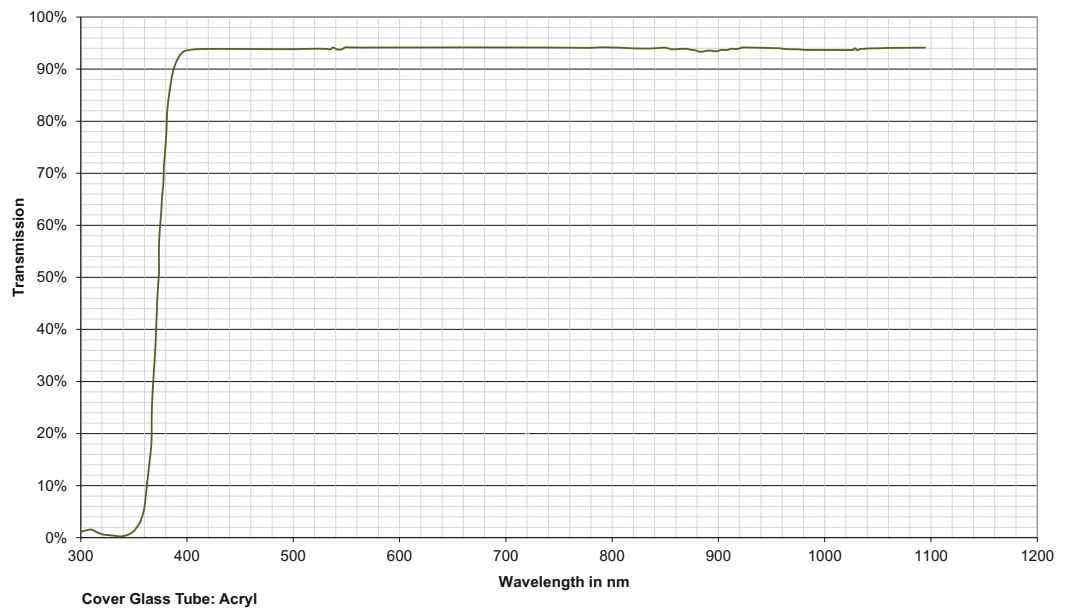
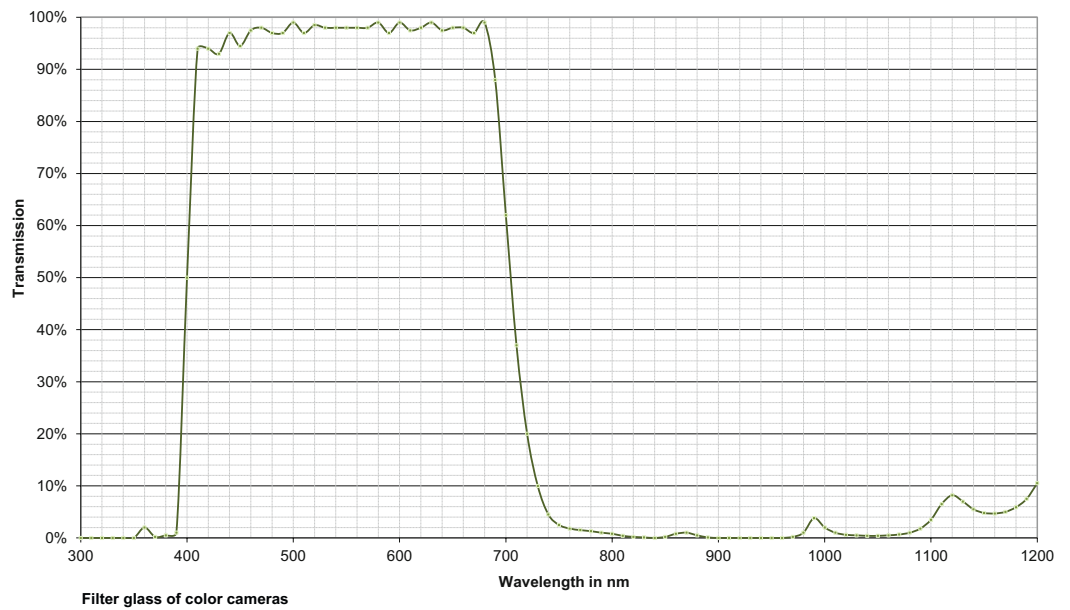

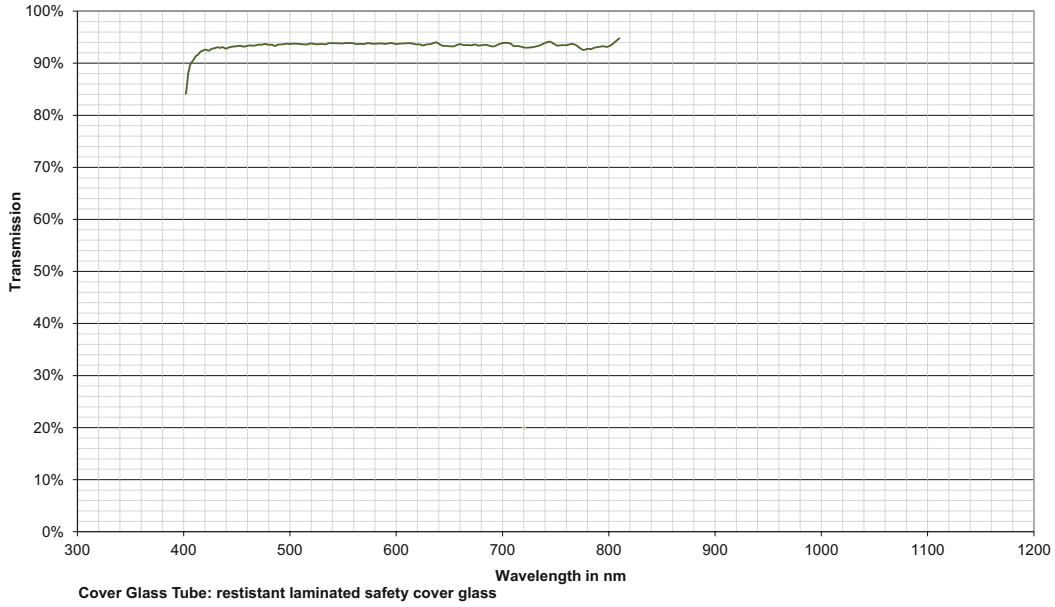

Cameras

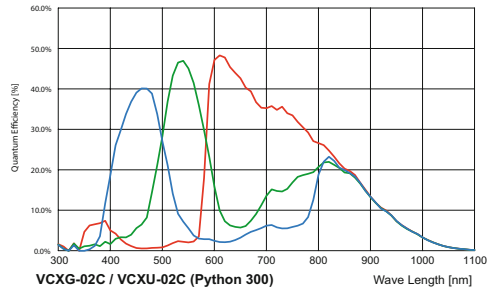
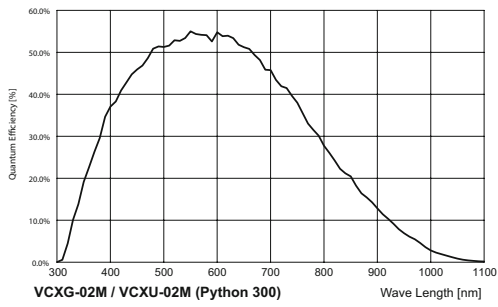

Spectral sensitivities for Baumer cameras with 0.3 MP sensor.

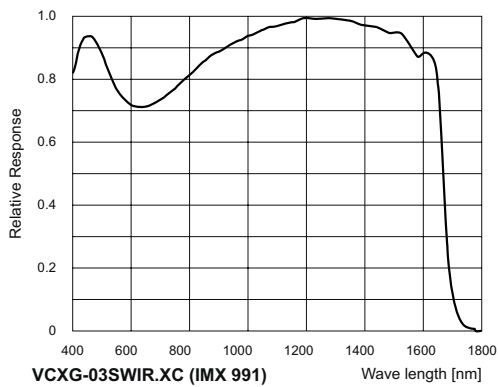

Spectral sensitivities for Baumer cameras with 0.3 MP SWIR sensor.

Spectral sensitivities for Baumer cameras with 0.4 MP sensor.

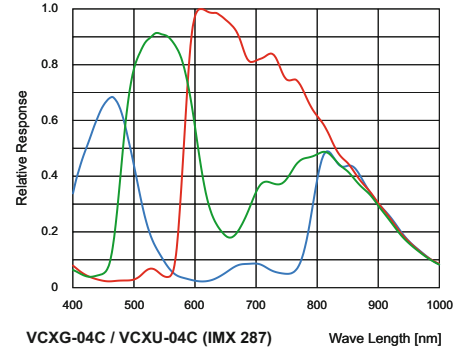
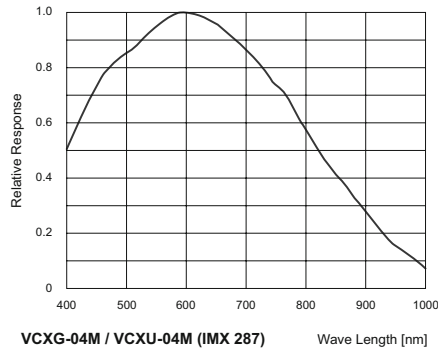

Spectral sensitivities for Baumer cameras with 1.3 MP sensor.

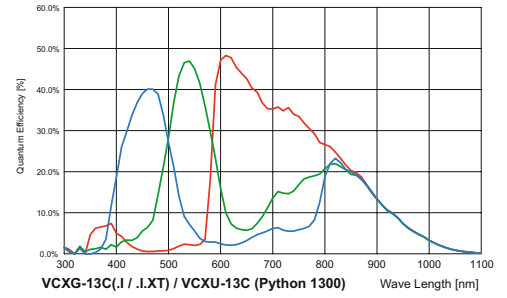
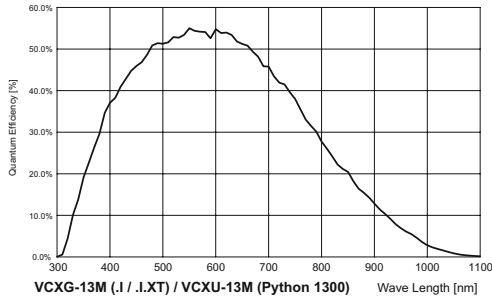

Spectral sensitivities for Baumer cameras with 1.3 MP sensor.

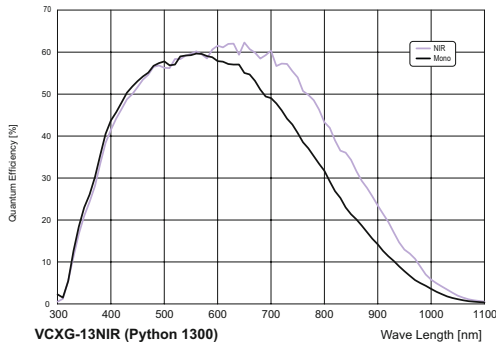

Spectral sensitivities for Baumer cameras with 1.3 MP SWIR sensor.

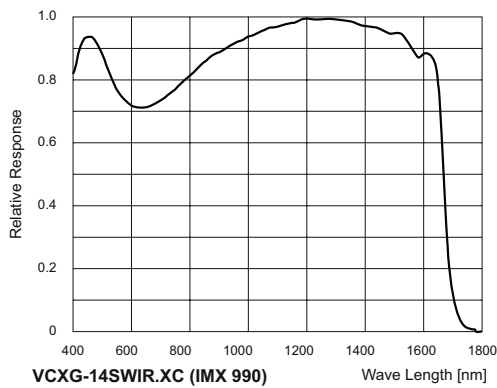

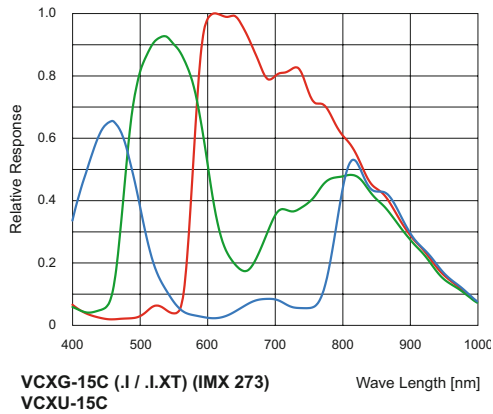
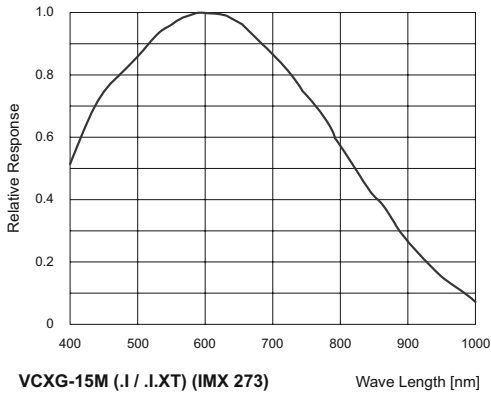

Spectral sensitivities for Baumer cameras with 1.5 MP sensor.

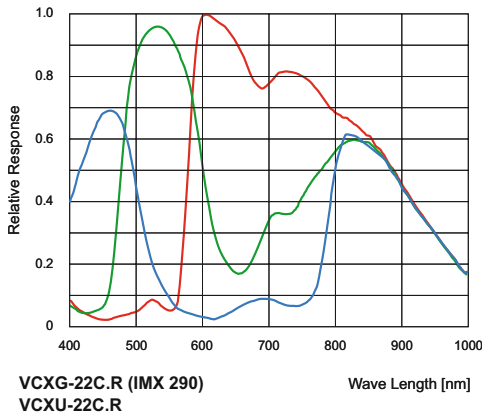
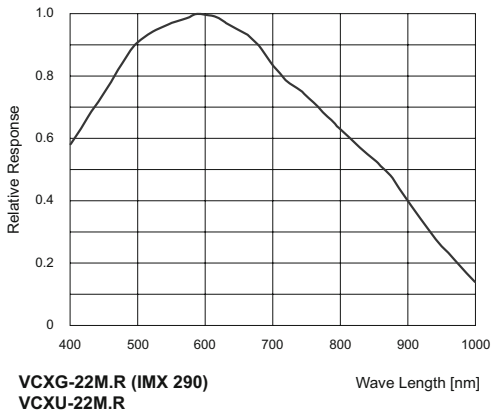

Spectral sensitivities for Baumer cameras with 2.1 MP sensor.

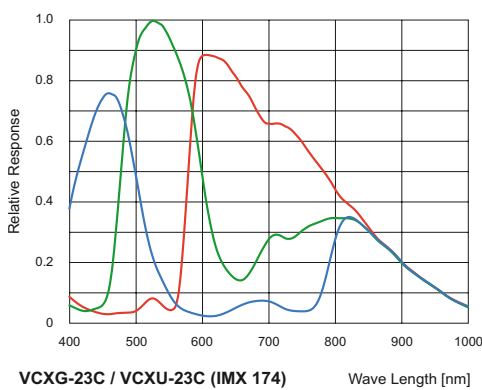
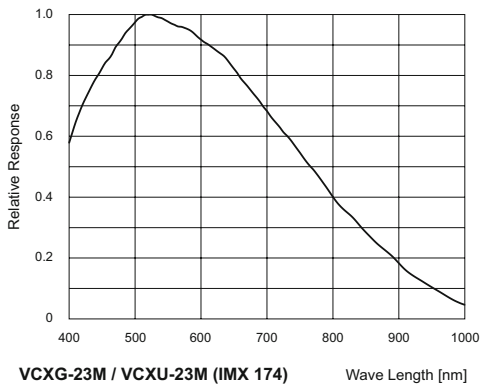

Spectral sensitivities for Baumer cameras with 2.3 MP sensor.

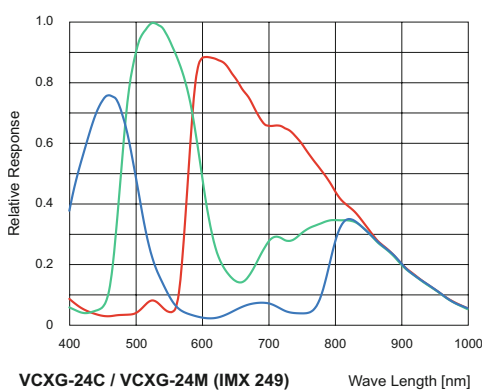
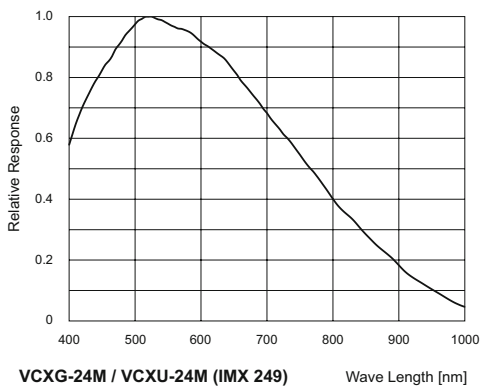

Spectral sensitivities for Baumer cameras with 2.3 MP sensor.

Spectral sensitivities for Baumer cameras with 2.3 MP sensor.

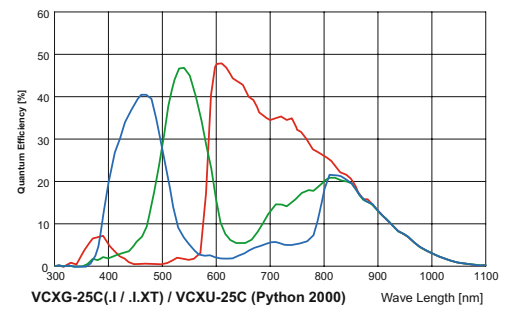
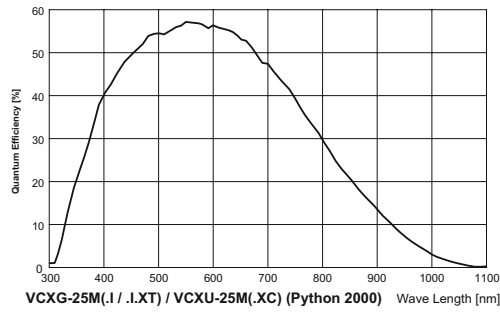

Spectral sensitivities for Baumer cameras with 3.1 MP sensor.

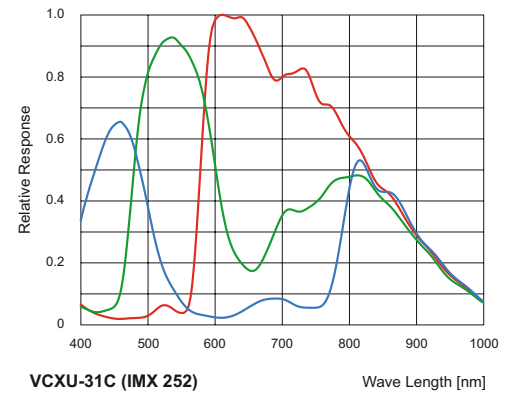
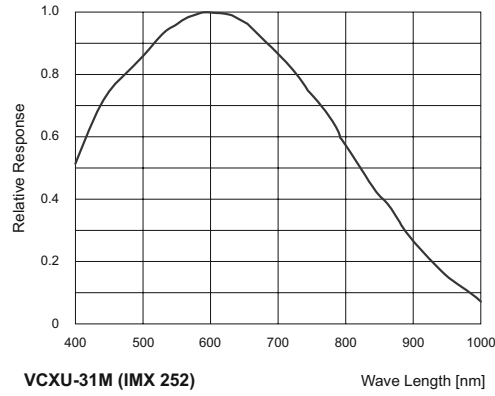

Spectral sensitivities for Baumer cameras with 3.1 MP sensor.

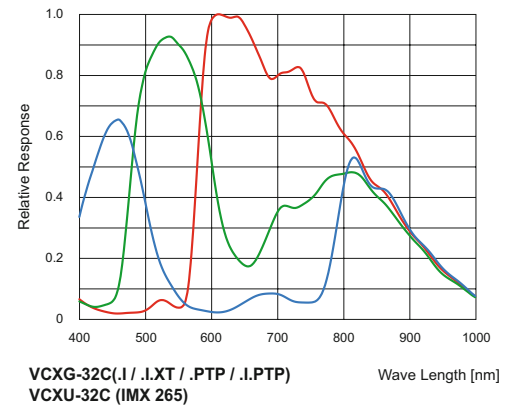
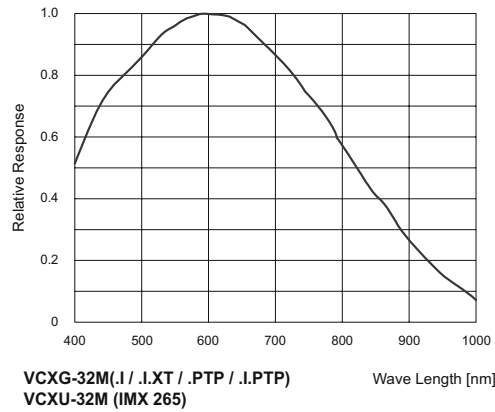

Spectral sensitivities for Baumer monochrome polarized Matrix, cameras with 5.0 MP sensor.

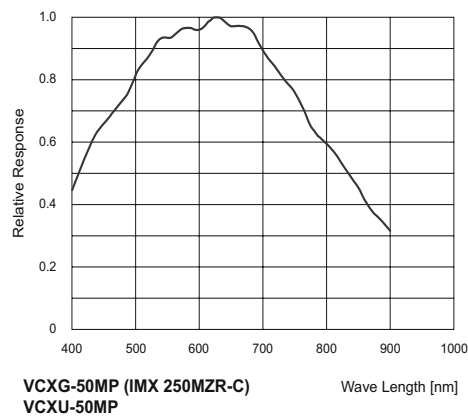

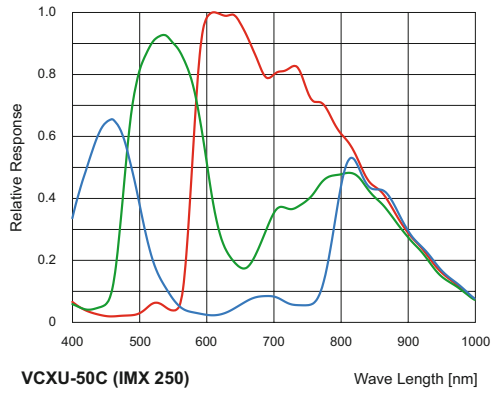
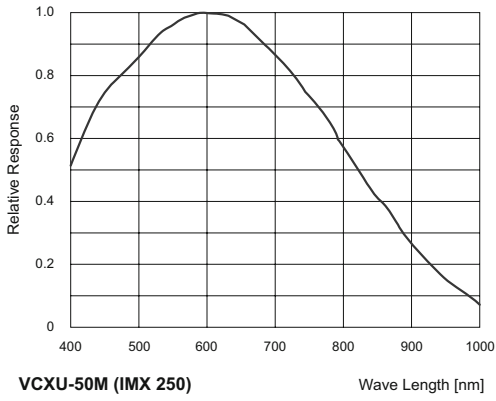

Spectral sensitivities for Baumer cameras with 5.0 MP sensor.

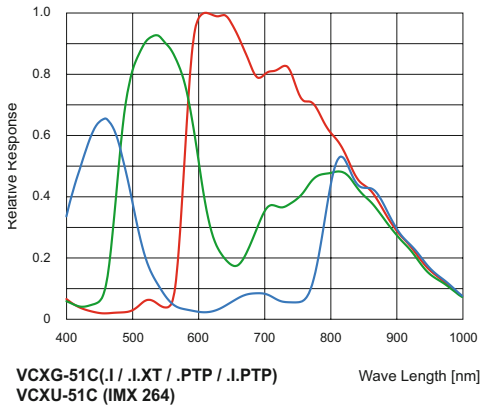
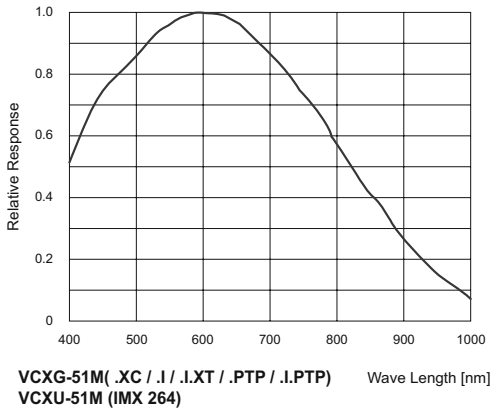

Spectral sensitivities for Baumer cameras with 5.0 MP sensor.

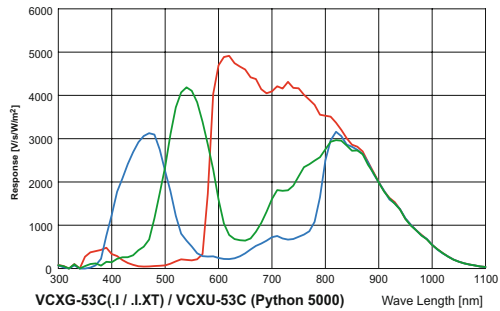
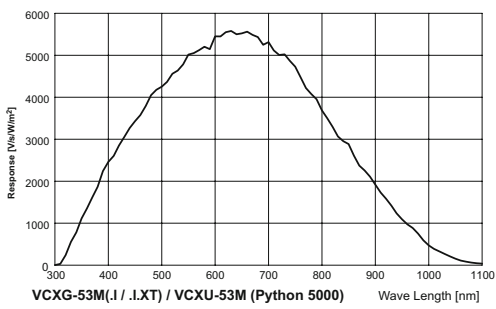

Spectral sensitivities for Baumer cameras with 5.3 MP sensor.

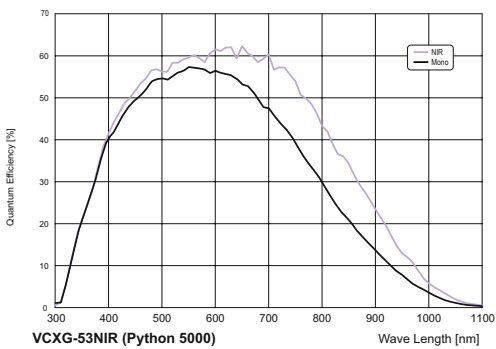

Spectral sensitivities for Baumer cameras with 5.3 MP sensor.

Spectral sensitivities for Baumer cameras with 6.2 MP sensor.

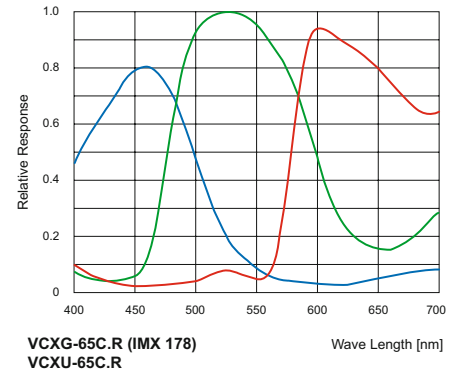
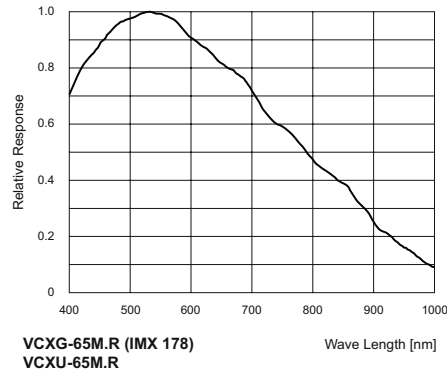

Spectral sensitivities for Baumer cameras with 8 MP sensor.

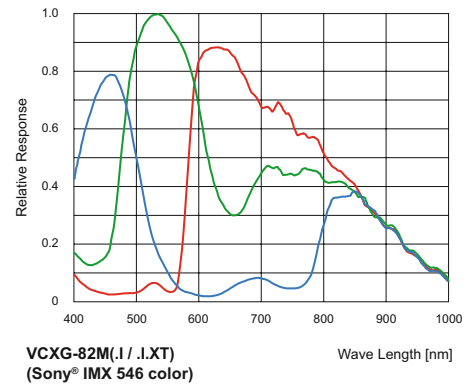
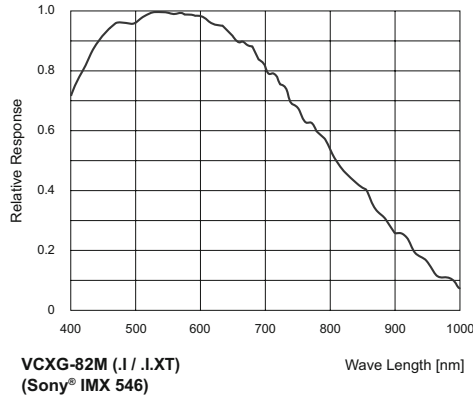

Spectral sensitivities for Baumer cameras with 9.0 MP sensor.

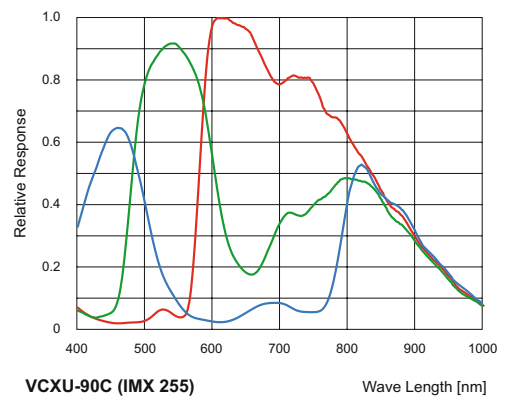
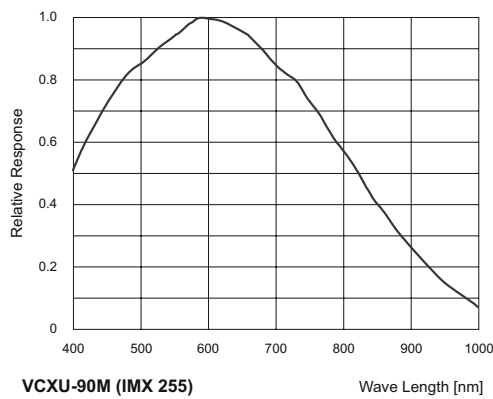

Spectral sensitivities for Baumer cameras with 9.0 MP sensor.

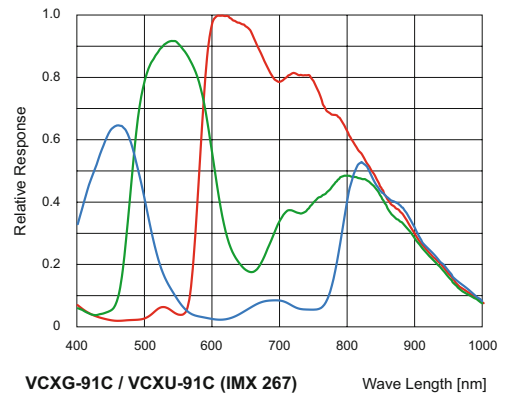
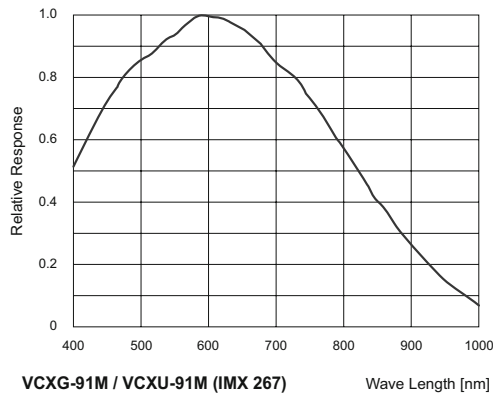

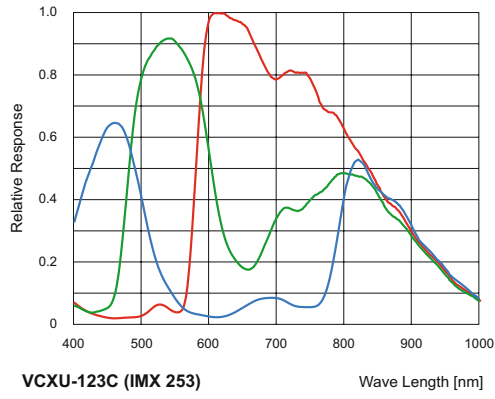
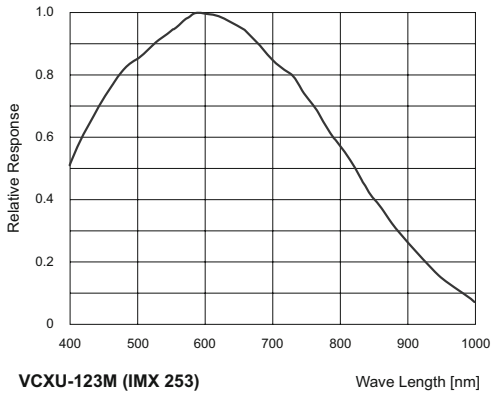

Spectral sensitivities for Baumer cameras with 12.3 MP sensor.

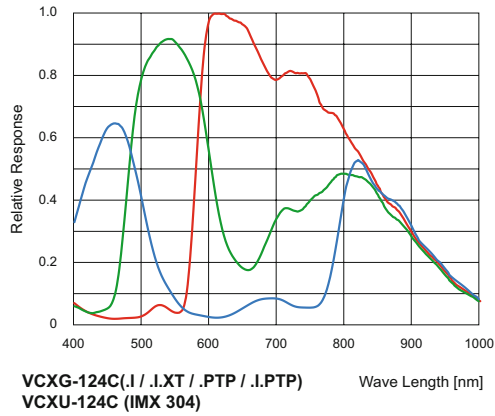
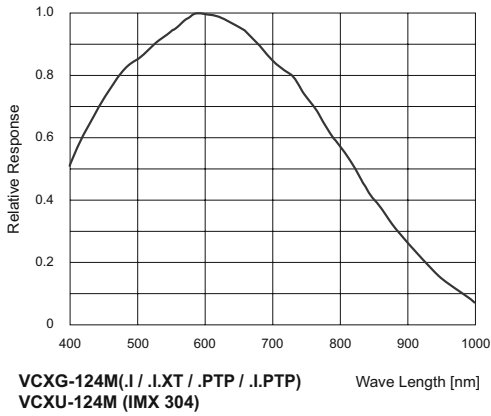

Spectral sensitivities for Baumer cameras with 12.3 MP sensor.

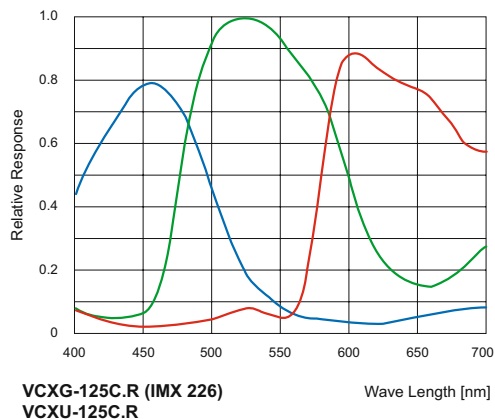
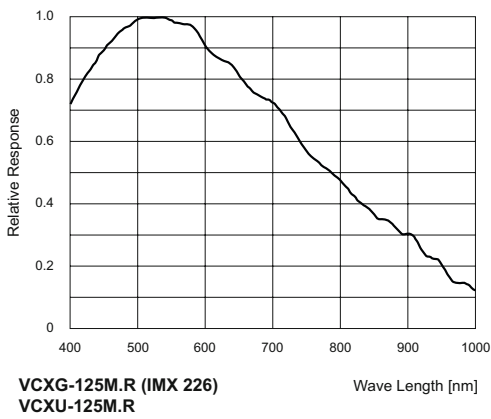

Spectral sensitivities for Baumer cameras with 12.3 MP sensor.

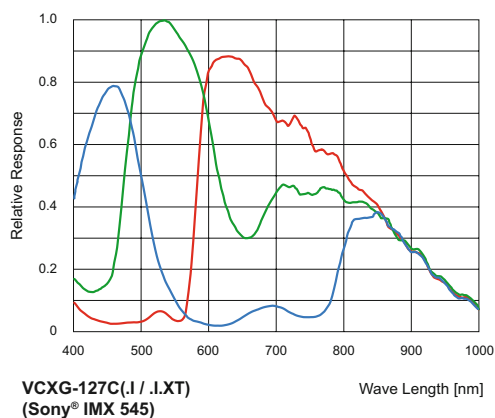
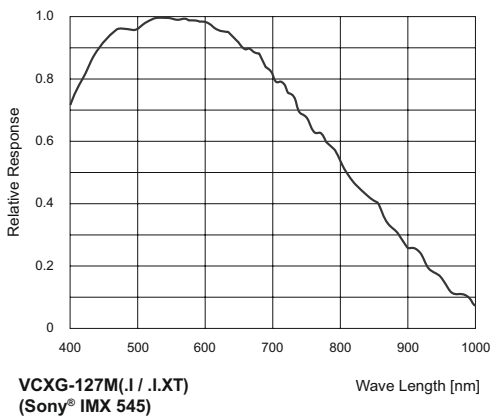

Spectral sensitivities for Baumer cameras with 12.2 MP sensor.

Spectral sensitivities for Baumer cameras with 20 MP sensor.

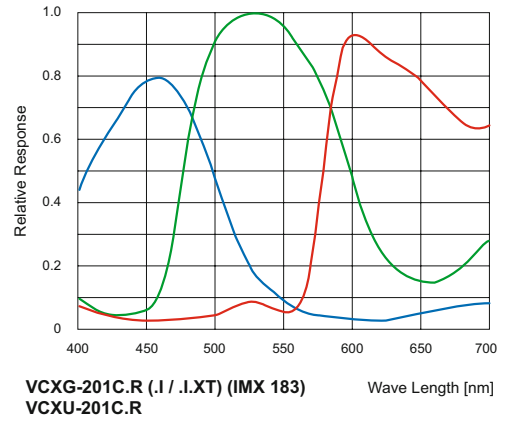
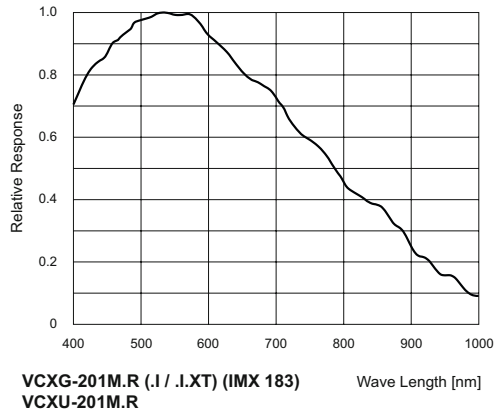

Spectral sensitivities for Baumer cameras with 20.1 MP sensor.

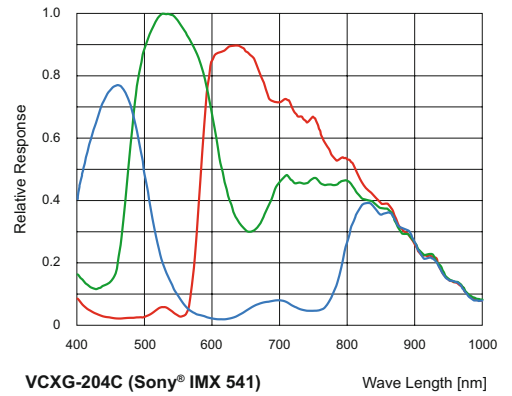
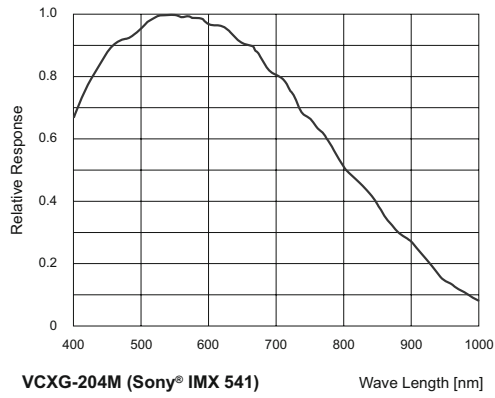

Spectral sensitivities for Baumer cameras with 24 MP sensor.

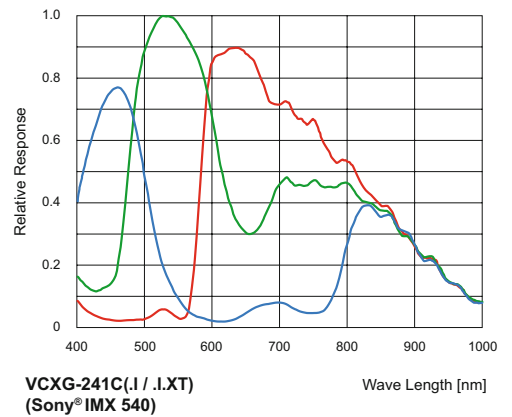
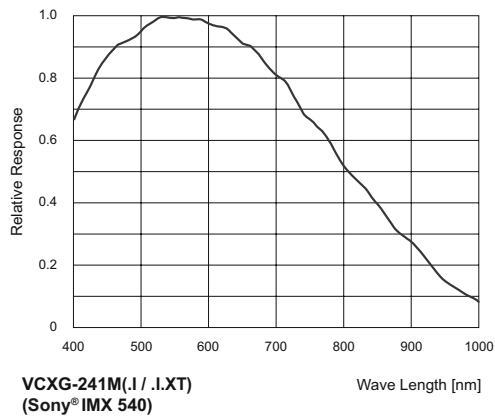

6.2 Sensor position accuracy

The typical accuracy by assumption of the root mean square value is displayed in the figures and the tables below:

6.2.1 VCXG / .XC / .PTP

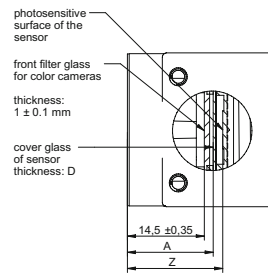
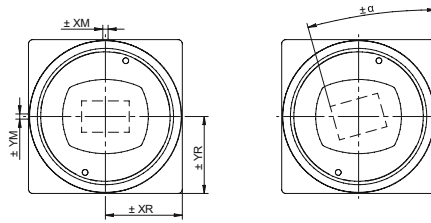

Camera Type	$\pm X_M$ [mm]	$\pm Y_M$ [mm]	$\pm X_R$ [mm]	$\pm Y_R$ [mm]	Z^{***}_{typ} [mm]	$\pm \alpha_{typ}$ [°]	A^{***} [mm]	D^{**} [mm]
VCXG-02*	0.05	0.05	0.05	0.05	17.55 ± 0.100	0.6	16.6	0.55
VCXG-03*	0.06	0.06	0.06	0.06	17.63 ± 0.070	0.6	15.8	0.50
VCXG-04*	0.07	0.07	0.07	0.07	17.63 ± 0.070	0.6	16.4	0.70
VCXG-13*	0.05	0.05	0.05	0.05	17.55 ± 0.100	0.6	16.6	0.55
VCXG-14*	0.06	0.06	0.06	0.06	17.63 ± 0.070	0.6	15.8	0.50
VCXG-15*	0.07	0.07	0.07	0.07	17.63 ± 0.070	0.6	16.4	0.70
VCXG-22*	0.06	0.06	0.06	0.06	17.58 ± 0.070	0.6	16.6	0.50
VCXG-23*	0.06	0.06	0.06	0.06	17.63 ± 0.070	0.4	15.8	0.50
VCXG-24*	0.06	0.06	0.06	0.06	17.63 ± 0.070	0.4	15.8	0.50
VCXG-25*	0.05	0.05	0.05	0.05	17.65 ± 0.070	0.6	16.5	0.55
VCXG-32*	0.17	0.17	0.17	0.17	17.63 ± 0.070	0.6	16.5	0.70
VCXG-50*	0.17	0.17	0.17	0.17	17.63 ± 0.070	0.6	16.5	0.70
VCXG-51*	0.17	0.17	0.17	0.17	17.63 ± 0.070	0.6	16.5	0.70
VCXG-53*	0.05	0.05	0.05	0.05	17.65 ± 0.070	0.6	16.5	0.55
VCXG-65*	0.06	0.06	0.06	0.06	17.63 ± 0.070	0.4	16.4	0.50
VCXG-82*	0.06	0.06	0.06	0.06	17.63 ± 0.070	0.4	15.8	0.50
VCXG-91*	0.17	0.17	0.17	0.17	17.63 ± 0.070	0.6	16.5	0.70
VCXG-124*	0.17	0.17	0.17	0.17	17.63 ± 0.070	0.6	16.5	0.70
VCXG-125*	0.06	0.06	0.06	0.06	17.63 ± 0.070	0.4	16.5	0.50
VCXG-127*	0.06	0.06	0.06	0.06	17.63 ± 0.070	0.4	15.8	0.50
VCXG-201*	0.06	0.06	0.06	0.06	17.63 ± 0.070	0.6	15.8	0.50
VCXG-204*	0.06	0.06	0.06	0.06	17.63 ± 0.070	0.4	15.8	0.50
VCXG-241*	0.06	0.06	0.06	0.06	17.63 ± 0.070	0.6	15.8	0.50

typical accuracy by assumption of the root mean square value
* C or M

** Dimension D in this table is from manufacturer datasheet

*** For color add 0.35 mm to nominal value

6.2.2 VCXG.I / .I.XT / .I.PTP

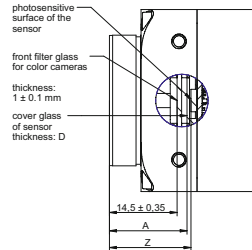
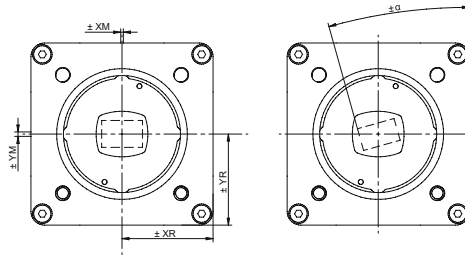

typical accuracy by
assumption of the root
mean square value

* C or M

** Dimension D in this
table is from manufac-
turer datasheet

*** For color add 0.35
mm to nominal value

Camera Type	$\pm x_M$ [mm]	$\pm y_M$ [mm]	$\pm x_R$ [mm]	$\pm y_R$ [mm]	Z^{***}_{typ} [mm]	$\pm \alpha_{typ}$ [°]	A^{***} [mm]	D^{**} [mm]
VCXG.I-13*	0.05	0.05	0.05	0.05	17.55 ± 0.100	0.6	16.6	0.55
VCXG.I-15*	0.07	0.07	0.07	0.07	17.63 ± 0.070	0.6	16.4	0.70
VCXG.I-25*	0.05	0.05	0.05	0.05	17.65 ± 0.070	0.6	16.5	0.55
VCXG.I-32*	0.17	0.17	0.17	0.17	17.63 ± 0.070	0.6	16.5	0.70
VCXG.I-51*	0.17	0.17	0.17	0.17	17.63 ± 0.070	0.6	16.5	0.70
VCXG.I-53*	0.05	0.05	0.05	0.05	17.65 ± 0.070	0.6	16.5	0.55
VCXG.I-82*	0.06	0.06	0.06	0.06	17.63 ± 0.070	0.4	15.8	0.50
VCXG.I-124*	0.17	0.17	0.17	0.17	17.63 ± 0.070	0.6	16.5	0.70
VCXG.I-127*	0.06	0.06	0.06	0.06	17.63 ± 0.070	0.4	15.8	0.50
VCXG.I-201*	0.06	0.06	0.06	0.06	17.63 ± 0.070	0.6	15.8	0.50
VCXG.I-241*	0.06	0.06	0.06	0.06	17.63 ± 0.070	0.4	15.8	0.50

6.2.3 VCXU / .XC

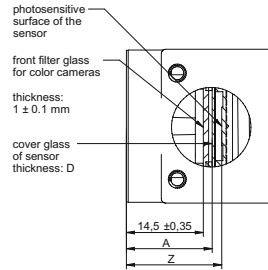
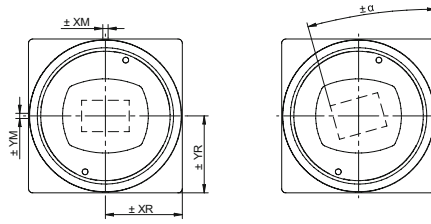

Camera Type	$\pm X_M$ [mm]	$\pm y_M$ [mm]	$\pm X_R$ [mm]	$\pm Y_R$ [mm]	Z^{***}_{typ} [mm]	$\pm \alpha_{typ}$ [°]	A^{***} [mm]	D^{**} [mm]
VCXU-02*	0.05	0.05	0.05	0.05	17.55 ± 0.100	0.6	16.6	0.55
VCXU-04*	0.07	0.07	0.07	0.07	17.63 ± 0.070	0.6	16.4	0.70
VCXU-13*	0.05	0.05	0.05	0.05	17.55 ± 0.100	0.6	16.6	0.55
VCXU-15*	0.07	0.07	0.07	0.07	17.63 ± 0.070	0.6	16.4	0.70
VCXU-22*	0.06	0.06	0.06	0.06	17.58 ± 0.070	0.6	16.6	0.50
VCXU-23*	0.06	0.06	0.06	0.06	17.63 ± 0.070	0.4	15.8	0.50
VCXU-24*	0.06	0.06	0.06	0.06	17.63 ± 0.070	0.4	15.8	0.50
VCXU-25*	0.05	0.05	0.05	0.05	17.65 ± 0.070	0.6	16.5	0.55
VCXU-31*	0.17	0.17	0.17	0.17	17.63 ± 0.070	0.6	16.5	0.70
VCXU-32*	0.17	0.17	0.17	0.17	17.63 ± 0.070	0.6	16.5	0.70
VCXU-50*	0.17	0.17	0.17	0.17	17.63 ± 0.070	0.6	16.5	0.70
VCXU-51*	0.17	0.17	0.17	0.17	17.63 ± 0.070	0.6	16.5	0.70
VCXU-53*	0.05	0.05	0.05	0.05	17.65 ± 0.070	0.6	16.5	0.55
VCXU-65*	0.06	0.06	0.06	0.06	17.63 ± 0.070	0.4	16.4	0.50
VCXU-90*	0.17	0.17	0.17	0.17	17.63 ± 0.070	0.6	16.5	0.70
VCXU-91*	0.17	0.17	0.17	0.17	17.63 ± 0.070	0.6	16.5	0.70
VCXU-123*	0.17	0.17	0.17	0.17	17.63 ± 0.070	0.6	16.5	0.70
VCXU-124*	0.17	0.17	0.17	0.17	17.63 ± 0.070	0.6	16.5	0.70
VCXU-125*	0.06	0.06	0.06	0.06	17.63 ± 0.070	0.4	16.5	0.50
VCXU-201*	0.06	0.06	0.06	0.06	17.63 ± 0.070	0.6	15.8	0.50

typical accuracy by assumption of the root mean square value
* C or M

** Dimension D in this table is from manufacturer datasheet

*** For color add 0.35 mm to nominal value

6.3 Software

6.3.1 Baumer GAPI

Baumer GAPI stands for **B**aumer **G**eneric **A**pplication **P**rogramming **I**nterface". With this API Baumer provides an interface for quick and easy integration of Baumer industrial cameras using C++, C, and C# (Windows only). This software interface allows changing to other camera models.

This API supports Windows, Linux and ARM-based platforms.

More information can be found at: www.baumer.com/vision/software

6.3.2 NeoAPI

The NeoAPI is a powerful, user-friendly API for camera integration. It allows quick integration of Baumer cameras in C++, C#, and Python with only a few lines of code.

This API supports Windows, Linux and ARM-based platforms.

More information can be found at: www.baumer.com/neoAPI

6.3.3 3rd Party Software

Strict compliance with the GenICam™ standard allows Baumer to offer the use of 3rd Party Software for operation with cameras of this series.

You can find a current listing of 3rd Party Software, which was tested successfully in combination with Baumer cameras, at: <https://www.baumer.com/c/14180>

7. Camera Functions

The camera features are represented by a GenICam™ compliant XML description file. The following chapter describes all available features included there. Most of the camera's features are standardized in the GenICam™ SFNC and must use the name defined there. Specialized features not mapping to an existing GenICam™ SFNC name are included as vendor-specific within the 'Custom' namespace.

The camera features are functional grouped by Category features. This elements can be used by software to display the features in more organized way.

Notice

Not all features listed here are supported by every camera.

You can view the functionality of your camera in the feature widget ¹ of the *Camera Explorer*.

Please refer to the appropriate documentation.

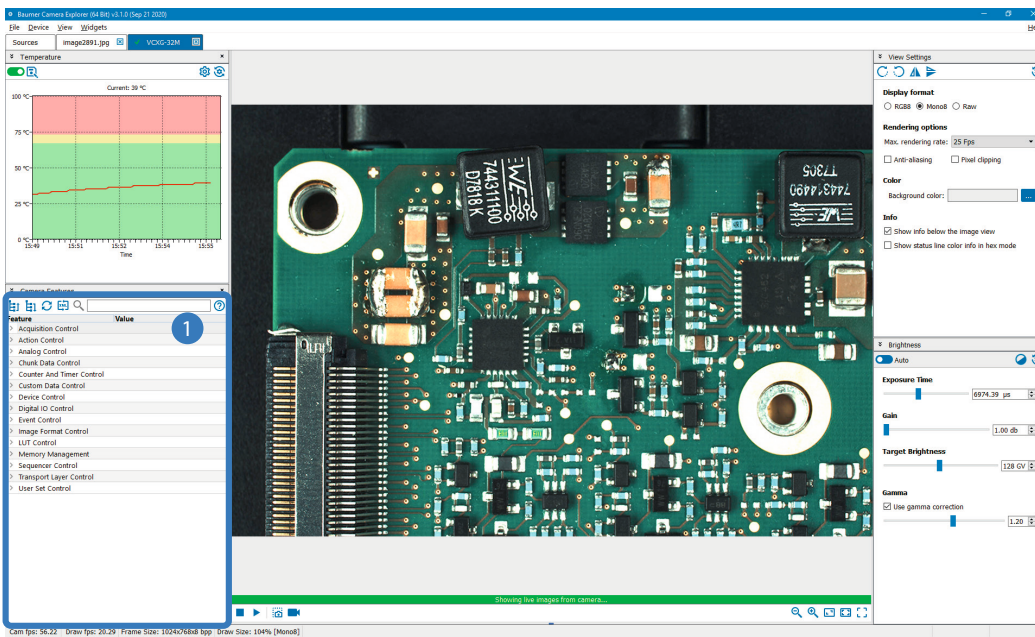

Camera Explorer ≥ v3.0 with highlighted feature widget

Category: AcquisitionControl

This chapter describes all features related to image acquisition, including the trigger and exposure control.

7.3.1 AcquisitionAbort

The acquisition abort process is a special case in which the current acquisition is stopped. If an exposure is running, the exposure is aborted immediately and the image is not read out.

Name	AcquisitionAbort
Category	AcquisitionControl
Interface	ICommand
Access	Write only
Unit	-
Values	-

7.3.2 AcquisitionFrameCount

Number of frames to acquire in MultiFrame Acquisition mode

Name	AcquisitionFrameCount
Category	AcquisitionControl
Interface	IInteger
Access	Read / Write
Unit	-
Values	1 - 65535 (Increment: 1)

7.3.3 AcquisitionFrameRate

Controls the acquisition rate (in Hertz) at which the frames are captured.

Notice

For cameras that use the PTP functionality, the generation of the frame rate is based on the synchronized timestamp. This ensures the synchronous recording of frames.

The *PtpServoStatus* feature must be locked to use this functionality.

Name	AcquisitionFrameRate
Category	AcquisitionControl
Interface	IFloat
Access	Read / Write
Unit	Hz
Values	dedends on camera

7.3.4 AcquisitionFrameRateEnable

Enables the acquisition at the framerate specified by AcquisitionFrameRate.

Name	AcquisitionFrameRateEnable
Category	AcquisitionControl
Interface	IBoolean
Access	Read / Write
Unit	-
Values	true = 1 (On) false = 0 (Off)

7.3.5 AcquisitionMode

Sets the acquisition mode of the device. It defines mainly the number of frames to capture during an acquisition and the way the acquisition stops.

Notice

The camera must be stopped before this feature can be edited.

Name	AcquisitionMode						
Category	AcquisitionControl						
Interface	IEnumeration						
Access	Read / Write						
Unit	-						
Values	<table><tr><td>Continuous</td><td>Frames are captured continuously without external events until stopped with the AcquisitionStop command.</td></tr><tr><td>MultiFrame</td><td>In this mode a predefined number of frames will be captured after AcquisitionStart. The AcquisitionFrameCount controls the number of captured frames. Then the acquisition is automatically stopped.</td></tr><tr><td>SingleFrame</td><td>In this mode the camera is captured one frame after AcquisitionStart. Then the acquisition is stopped.</td></tr></table>	Continuous	Frames are captured continuously without external events until stopped with the AcquisitionStop command.	MultiFrame	In this mode a predefined number of frames will be captured after AcquisitionStart. The AcquisitionFrameCount controls the number of captured frames. Then the acquisition is automatically stopped.	SingleFrame	In this mode the camera is captured one frame after AcquisitionStart. Then the acquisition is stopped.
Continuous	Frames are captured continuously without external events until stopped with the AcquisitionStop command.						
MultiFrame	In this mode a predefined number of frames will be captured after AcquisitionStart. The AcquisitionFrameCount controls the number of captured frames. Then the acquisition is automatically stopped.						
SingleFrame	In this mode the camera is captured one frame after AcquisitionStart. Then the acquisition is stopped.						

7.3.6 AcquisitionStart

Once image acquisition has started, the camera processes the images in three steps:

- Determining the current set of image parameters
- Sensor exposure
- Readout from the sensor.

This process is then repeated until the camera is stopped.

Notice

Certain settings which affect the image format can only be adjusted if the camera is stopped.

This includes:

- PixelFormat
- Region of Interest (OffsetX / OffsetY / Width / Height)

Name	AcquisitionStart
Category	AcquisitionControl
Interface	ICommand
Access	Write only
Unit	-
Values	-

7.3.7 AcquisitionStatus

Reads the state of the internal acquisition signal selected using *AcquisitionStatusSelector*.

Name	AcquisitionStatus
Category	AcquisitionControl
Interface	IBoolean
Access	Read only
Unit	-
Values	true = 1 (On) false = 0 (Off)

7.3.8 AcquisitionStatusSelector

Selects the internal acquisition signal to read using AcquisitionStatus.

Name	AcquisitionStatusSelector
Category	AcquisitionControl
Interface	IEnumeration
Access	Read / Write
Unit	-
Values	Acquisition Active Device is currently doing an acquisition of one or many frames. Acquisition Trigger Wait Device is currently waiting for a trigger for the capture of one or many frames.

7.3.9 AcquisitionStop

Stops the Acquisition of the device at the end of the current Frame.

Name	AcquisitionStop
Category	AcquisitionControl
Interface	ICommand
Access	Write only
Unit	-
Values	-

7.3.10 ExposureAuto (except .PTP / .I.PTP)

Sets the automatic exposure mode when ExposureMode is Timed. The exact algorithm used to implement this control is device-specific.

Notice

For rolling shutter cameras, the function is only available in Sensor Shutter Mode: *Rolling Shutter*.

Name	ExposureAuto	
Category	AcquisitionControl	
Interface	IEnumeration	
Access	Read / Write	
Unit	-	
Values	Continuous	Exposure duration is constantly adapted by the device to maximize the dynamic range.
	Off	Exposure duration is user controlled using ExposureTime.
	Once	Exposure duration is adapted once by the device. Once it has converged, it returns to the Off state.

7.3.11 ExposureMode

Sets the operation mode of the Exposure (or shutter).

Name	ExposureMode	
Category	AcquisitionControl	
Interface	IEnumeration	
Access	Read / Write	
Unit	-	
Values	Timed	Timed exposure. The exposure duration time is set using the ExposureTime or ExposureAuto features and the exposure starts with the FrameStart or LineStart.

7.3.12 ExposureTime

On exposure of the sensor, the inclination of photons produces a charge separation on the semiconductors of the pixels. This results in a voltage difference, which is used for signal extraction.

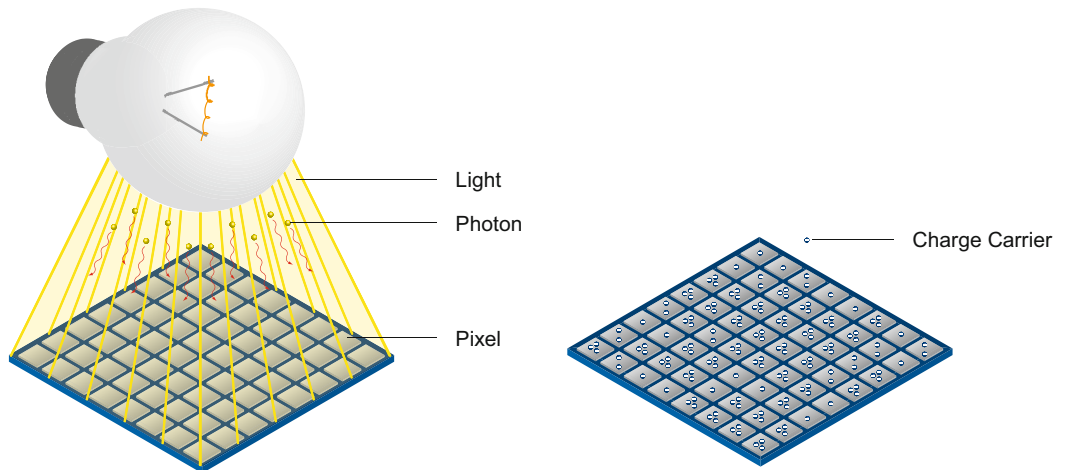

The signal strength is influenced by the incoming amount of photons. It can be increased by increasing the exposure time (t_{exposure}).

Name	ExposureTime
Category	AcquisitionControl
Interface	IFloat
Access	Read / Write
Unit	μs
Values	see tables below

Notice

Only for cameras with rolling shutter sensors!

The modification of the Exposure Time is done by reconfiguration of the sensor.

If the modification occurs during a sensor readout, the update will be delayed until the end of the current readout.

Notice

Due to the sensor, fixed pattern noise effects can occur at high exposure times. You can counteract this by setting the gain to a value of approximately 1.5 and reducing the exposure time accordingly.

Notice

In order to set a short exposure time for cameras with release 2.1, the *Short Exposure Time Enable* feature must be enabled.

If the feature *Short Exposure Time Enable* is enabled and the exposure time is changed e.g. from 20 μsec to lower than 15 μsec , this will change the internal parameters of the sensors and the sensor needs to reinitialize.

This initialization sequence takes about 50 msec. This process is only necessary, if the exposure range is changed. If the new exposure value is within the default exposure range, no initialization is necessary.

Notice

It is not possible to use the *Sequencer* when the feature *Short Exposure Time Enable* is enabled.

7.3.12.1 VCXG /.XC / ./I/ .I.XT / .PTP / .I.PTP

Camera Type	$t_{\text{exposure min}}^*$ [μsec]	$t_{\text{non-selectable range}}^1)$	$t_{\text{exposure max}}$ [sec]
	Release 1.1 Release 2.0 Release 2.1 Release 2.2 Release 3.0 Release 4.0 Release 4.1 Release 4.3	ExposureTimeGapMin - Exposure- TimeGapMax	
Monochrome			
VCXG-02M	20 20 20 x 20 x		1
VCXG-03SWIR.XC	x x x x x x x 20		60
VCXG-04M	x x 1 x 1 x		60
VCXG-13M / ./I/ .I.XT	20 20 20 x 20 x		1
VCXG-13NIR	x x x x 20 x		1
VCXG-14SWIR.XC	x x x x x x 20		60
VCXG-15M / ./I/ .I.XT	x x 1 x 1 x		60
VCXG-22M.R	x x x 15 x x		60
VCXG-23M	35 35 35 x 35 x		60
VCXG-24M	57 57 57 x 57 x		60
VCXG-25M / ./I/ .I.XT	20 20 20 x 20 x		1
VCXG-32M / ./I/ .I.XT/ .PTP/ .I.PTP	50 50 1 x 1 x		60
VCXG-50MP	x x x 1 x x		60
VCXG-51M / .XC / ./I/ .I.XT/ .PTP/ .I.PTP	43 43 1 x 1 x		60
VCXG-53M / ./I/ .I.XT	20 20 20 x x		1
VCXG-53NIR	x x x x 20 x		1
VCXG-65M.R	x x x x 21 x		60
VCXG-82M / ./I/ .I.XT	x x x x x 1	4 - 22 μs	60
VCXG-91M	x x 1 x 1 x		60
VCXG-124M / ./I/ .I.XT/ .PTP/ .I.PTP	60 60 1 x 1 x		60
VCXG-125M.R	x x x 85 85 x		60
VCXG-127M / ./I/ .I.XT	x x x x x 1	4 - 30 μs	60
VCXG-201M.R / ./I/ .I.XT	x x x 115 115 x		60
VCXG-204M	x x x x x 1	4 - 33 μs	60
VCXG-241M / ./I/ .I.XT	x x x x 39 1	4 - 38 μs	60
Color			
VCXG-02C	20 20 20 x 20 x		1
VCXG-04C	x x 1 x 1 x		60
VCXG-13C / ./I/ .I.XT	20 20 20 x 20 x		1
VCXG-15C / ./I/ .I.XT	x x 1 x 1 x		60
VCXG-22C.R	x x x 15 x x		60
VCXG-23C	35 35 35 x 35 x		60
VCXG-24C	57 57 57 x 57 x		60
VCXG-25C / ./I/ .I.XT	20 20 20 x 20 x		1
VCXG-32C / ./I/ .I.XT/ .PTP/ .I.PTP	50 50 1 x 1 x		60
VCXG-51C / ./I/ .I.XT/ .PTP/ .I.PTP	43 43 1 x 1 x		60
VCXG-53C / ./I/ .I.XT	20 20 20 x 20 x		1
VCXG-65C.R	x x x x 21 x		60
VCXG-82C / ./I/ .I.XT	x x x x x 1	4 - 22 μs	60
VCXG-91C	x x 1 x 1 x		60
VCXG-124C / ./I/ .I.XT/ .PTP/ .I.PTP	x 60 1 x 1 x		60
VCXG-125C.R	x x x 85 85 x		60
VCXG-127C / ./I/ .I.XT	x x x x x 1	4 - 30 μs	60
VCXG-91C	x x 1 x 1 x		60
VCXG-201C.R / ./I/ .I.XT	x x x 115 115 x		60
VCXG-204C	x x x x x 1	4 - 33 μs	60
VCXG-241C / ./I/ .I.XT	x x x x 39 1	4 - 38 μs	60

Notice

VCXG-22M.R
VCXG-22C.R

In shutter mode *Global Reset* the exposure time can only be changed when the acquisition is stopped.

In the shutter mode *Rolling Shutter*, the acquisition does not have to be stopped.

^{*)} ./I/ .I.XT only Release 2.1 , 3.0
^{**) shutter mode *Global Reset*}
^{***) shutter mode *Rolling Shutter*}

¹⁾ range only relevant with activated *ShortExposureTimeEnable*

7.3.12.3 VCXU / .XC

Camera Type	$t_{\text{exposure min}}$ [μsec]	$t_{\text{exposure max}}$ [sec]
	Release 1.1 Release 2.0 Release 2.1 Release 2.2 Release 2.3 Release 3.0	
Monochrome		
VCXU-02M	30 20 x x x 20	1
VCXU-04M	x x 1 x x 1 1	60
VCXU-13M	30 20 x x x 20	1
VCXU-15M	x x 1 x x 1	60
VCXU-22M.R	x x x 135 x 135* x x x 15 x 15**	1.698* 60**
VCXU-23M	28 28 28 x x 28	60
VCXU-24M	57 57 57 x x 57	60
VCXU-25M / .XC	30 20 20 x x 20	1
VCXU-31M	26 26 1 x x 1	60
VCXU-32M	50 50 1 x x 1	60
VCXU-50M	45 30 1 x x 1	60
VCXU-50MP	x x x 1 x x	60
VCXU-51M	43 43 1 x x 1	60
VCXU-53M	30 20 20 x x 20	1
VCXU-65M.R	x x x x 75 75* x x x 14 14 14**	60
VCXU-90M	x 37 1 x x 1	60
VCXU-91M	x x 1 x x 1	60
VCXU-123M	37 37 1 x x 1	60
VCXU-124M	x x 1 x x 1	60
VCXU-125M.R	x x x 44 x 44	60
VCXU-201M.R	x x x 53 x 53	60
Color		
VCXU-02C	30 20 x x x 20	1
VCXU-04C	x x 1 x x 1	60
VCXU-13C	30 20 x x x 20	1
VCXU-15C	x x 1 x x 1	60
VCXU-22C.R	x x x 135 x 135* x x x 15 x 15**	1.698* 60**
VCXU-23C	45 28 28 x x 28	60
VCXU-24C	57 57 57 x x 57	60
VCXU-25C	30 20 20 x x 20	1
VCXU-31C	26 26 1 x x 1	60
VCXU-32C	50 50 1 x x 1	60
VCXU-50C	30 30 1 x x 1	60
VCXU-51C	43 43 1 x x 1	60
VCXU-53C	30 20 20 x x 20	1
VCXU-65C.R	x x x x 75 75* x x x 14 14 14**	60
VCXU-90C	x 37 1 x x 1	60
VCXU-91C	x x 1 x x 1	60
VCXU-123C	x 37 1 x x 1	60
VCXU-124C	x x 1 x x 1	60
VCXU-125C.R	x x x 44 x 44	60
VCXU-201C.R	x x x 53 x 53	60

Notice

VCXU-22M.R / VCXU-22C.R

In shutter mode *Global Reset* the exposure time can only be changed when the acquisition is stopped.

In the shutter mode *Rolling Shutter*, the acquisition does not have to be stopped.

*) shutter mode *Global Reset*

**) shutter mode *Rolling Shutter*

7.3.13 ExposureTimeGapMax (≥ Rel. 4 only)

Returns the maximum value of the exposure time gap.

Name	ExposureTimeGapMax
Category	AcquisitionControl
Interface	IFloat
Access	Read only
Unit	μs
Values	0 - 2,000,000.000000 (Increment: 1.00)

7.3.14 ExposureTimeGapMin (≥ Rel. 4 only)

Returns the minimum value of the exposure time gap.

Name	ExposureTimeGapMin
Category	AcquisitionControl
Interface	IFloat
Access	Read only
Unit	μs
Values	0 - 2,000,000.000000 (Increment: 1.00)

7.3.15 ReadoutMode

Specifies the operation mode of the readout for the acquisition.

Image acquisition consists of two separate procedures carried out in succession.

Exposing the pixels on the photosensitive surface of the sensor is only the first part of the image acquisition process. Once this first step is completed, the pixels are read out.

The exposure time (t_{exposure}) can be adjusted by the user, however, the time needed for the readout (t_{readout}) is determined by the particular sensor and image format in use.

The cameras can be operated sequential or overlapped depending on the mode and the combination of exposure and readout times used:

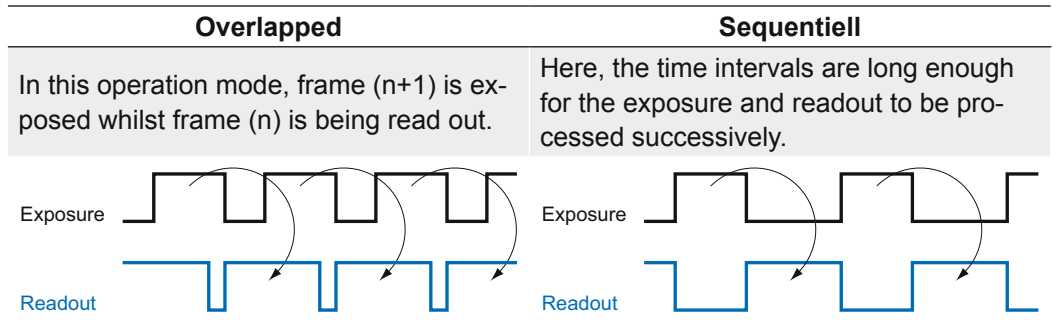

If the camera is unable to process incoming trigger signals, which means the camera should be triggered within the interval t_{notready} , these triggers are skipped. The user will be informed about this fact by means of the event "TriggerSkipped".

Depending on the ReadoutMode t_{notready} is determined as follows:

ReadoutMode: Overlapped

$$t_{\text{notready}} = t_{\text{exposure}(n)} + (t_{\text{readout}(n)} - t_{\text{exposure}(n+1)}) + t_{\text{Triggerdelay}}$$

ReadoutMode: Sequentiell

$$t_{\text{notready}} = t_{\text{exposure}(n)} + t_{\text{readout}(n)} + t_{\text{Triggerdelay}}$$

Notice

In Sensor Shutter Mode: *Global Reset* $t_{\text{TriggerDelay}}$ is constant and independent of image settings.

In Sensor Shutter Mode: *Rolling Shutter* $t_{\text{TriggerDelay}}$ is not constant (expect $t_{\text{exposure}} < T_{\text{Readout}}$) $T_{\text{TriggerDelay}}$ depends on image settings like:

- *ExposureTime*
- *PixelFormat*
- ...

Name	ReadoutMode	
Category	AcquisitionControl	
Interface	IEnumeration	
Access	Read / Write	
Unit	-	
Values	Overlapped	Overlapped ReadOutMode
	Sequential	Sequential ReadoutMode

7.3.16 ShortExposureTimeEnable

Controls if short exposure time should be supported.

Notice

It is not possible to use the *Sequencer* when the feature *Short Exposure Time Enable* is enabled.

Name	ShortExposureTimeEnable
Category	AcquisitionControl
Interface	IBoolean
Access	Read only
Unit	-
Values	true = 1 (On) false = 0 (Off)

7.3.17 TriggerActivation

Specifies the activation mode of the trigger.

Name	TriggerActivation
Category	AcquisitionControl
Interface	IEnumeration
Access	Read / Write
Unit	-
Values	FallingEdge Specifies that the trigger is considered valid on the falling edge of the source signal. RisingEdge Specifies that the trigger is considered valid on the rising edge of the source signal.

7.3.18 TriggerDelay

Specifies the delay in microseconds (us) to apply after the trigger reception before activating it.

Name	TriggerDelay
Category	AcquisitionControl
Interface	IFloat
Access	Read / Write
Unit	µs
Values	0 - 2,000,000.000000 (Increment: 1.00)

7.3.19 TriggerMode

Controls if the selected trigger is active.

Name	TriggerMode	
Category	AcquisitionControl	
Interface	IEnumeration	
Access	Read / Write	
Unit	-	
Values	Off	Disables the selected trigger.
	On	Enable the selected trigger.

V CXG / V CXU (only cameras with rolling shutter sensors)

The sensor TriggerMode depends on the SensorShutterMode.

Camera Type (Sensor)	Trigger Mode = On		Trigger Mode = Off	
	Shutter Mode	Readout Mode	Shutter Mode	Readout Mode
Monochrome / Color				
VCXG-22M.R	Global Reset	Non-overlapped	Global Reset	Non-overlapped
VCXG-22C.R	Rolling	Non-overlapped	Rolling	Overlapped
VCXU-22M.R	Global Reset	Non-overlapped	Global Reset	Non-overlapped
VCXU-22C.R	Rolling	Non-overlapped	Rolling	Overlapped
VCXG-65M.R	Global Reset	Non-overlapped	Global Reset	Non-overlapped
VCXG-65C.R	Rolling	Non-overlapped	Rolling	Overlapped
VCXU-65M.R	Global Reset	Non-overlapped	Global Reset	Non-overlapped
VCXU-65C.R	Rolling	Non-overlapped	Rolling	Overlapped
VCXG-201M.R (.I)	Global	Non-overlapped	Global Reset	Non-overlapped
VCXG-201C.R (.I)	Rolling	Non-overlapped	Rolling	Overlapped
VCXG-125M.R	Global Reset	Non-overlapped	Global Reset	Non-overlapped
VCXG-125C.R	Rolling	Non-overlapped	Rolling	Overlapped
VCXU-125M.R	Global Reset	Non-overlapped	Global Reset	Non-overlapped
VCXU-125C.R	Rolling	Non-overlapped	Rolling	Overlapped
VCXU-201M.R	Global Reset	Non-overlapped	Global Reset	Non-overlapped
VCXU-201C.R	Rolling	Non-overlapped	Rolling	Overlapped

7.3.19.1 Timings of the image transmission V CXG

Trigger Mode

The transfer of the first image starts after data for a complete packet size is stored in camera's TX memory. All further images start the transfer immediately after the first one is completed, if the camera works in burst mode with a high frame rate and the sensor acquires images faster than the interface can transfer. These additional pictures are not referenced to the time of the readout. If the sensor is triggered slowly enough, each image will behave like the first image.

Freerun Mode

The transfer of each image starts after data for a complete packet size is stored in the camera's TX memory. Since the sensor delivers more data than the interface can manage, depending on set ROI, images are repeatedly discarded and not transferred. Therefore, gaps of different sizes can be created via the GigE interface.

7.3.19.2 Timings of the image transmission VCXU / .XC

Trigger Mode

All images are written from sensor into memory as long as free buffers are available. If this burst memory is full, all following images are discarded by the sensor. The transfer of the first image starts with a small delay (about 2 lines). The data is read from the memory and transferred to the interface. The interface can now control reading from memory. Depending on the USB configuration (ThroughputLimit, blank packages), the interface can retrieve the data quickly enough or is lagging.

Freerun Mode

Only one alternating buffer is provided in the memory. The first image is written into the memory and immediately transferred to the interface with a small delay. The second image from the sensor is written into another buffer, which would be transferred immediately afterwards. If the interface is too slow due to the current configuration and the first image has not yet been transferred completely when the third image is already received from the sensor, the third image would overwrite the second one and would be transferred via the interface next.

7.3.20 TriggerOverlap

Specifies the type trigger overlap permitted with the previous frame.

Name	TriggerOverlap
Category	AcquisitionControl
Interface	IEnumeration
Access	Read / Write
Unit	-
Values	Read Out Trigger is accepted immediately after the exposure period.

7.3.21 TriggerSelector

Selects the type of trigger to configure.

Name	TriggerSelector
Category	AcquisitionControl
Interface	IEnumeration
Access	Read / Write
Unit	-
Values	Frame Start Selects the type of trigger to configure.

7.3.22 TriggerSoftware

Generates a internal trigger. *TriggerSource* must be set to Software.

Name	TriggerSoftware
Category	AcquisitionControl
Interface	ICommand
Access	Write only
Unit	-
Values	-

7.3.23 TriggerSource

Specifies the internal signal or physical input Line to use as the trigger source. The selected trigger must have its *TriggerMode* set to On.

Name	TriggerSource
Category	AcquisitionControl
Interface	IEnumeration
Access	Read / Write
Unit	-
Values	see table below

	VCXG / .XC / .PTP	VCXG.I/.XT / .PTP	VCXU/.XC
Action1	<input checked="" type="checkbox"/>	<input checked="" type="checkbox"/>	<input type="checkbox"/>
All	<input checked="" type="checkbox"/>	<input checked="" type="checkbox"/>	<input checked="" type="checkbox"/>
Line0	<input checked="" type="checkbox"/>	<input checked="" type="checkbox"/>	<input checked="" type="checkbox"/>
Line1	<input checked="" type="checkbox"/>	<input checked="" type="checkbox"/>	<input checked="" type="checkbox"/>
Line2	<input checked="" type="checkbox"/>	<input checked="" type="checkbox"/>	<input checked="" type="checkbox"/>
Line3	<input checked="" type="checkbox"/>	<input checked="" type="checkbox"/>	<input checked="" type="checkbox"/>
Line4	<input type="checkbox"/>	<input checked="" type="checkbox"/>	<input type="checkbox"/>
Line5	<input type="checkbox"/>	<input checked="" type="checkbox"/>	<input type="checkbox"/>
Line6	<input type="checkbox"/>	<input checked="" type="checkbox"/>	<input type="checkbox"/>
Line7	<input type="checkbox"/>	<input checked="" type="checkbox"/>	<input type="checkbox"/>
Off	<input checked="" type="checkbox"/>	<input checked="" type="checkbox"/>	<input checked="" type="checkbox"/>
Software	<input checked="" type="checkbox"/>	<input checked="" type="checkbox"/>	<input checked="" type="checkbox"/>

7.1 Category: Action Control (GigE only)

Category that contains the Action control features.

7.1.1 ActionDeviceKey

Provides the device key that allows the device to check the validity of action commands. The device internal assertion of an action signal is only authorized if the *ActionDeviceKey* and the action device key value in the protocol message are equal.

Name	ActionDeviceKey
Category	ActionControl
Interface	Integer
Access	Write only
Unit	HexNumber
Values	0 - 4294967295 (Increment: 1)

7.1.2 ActionGroupKey

Provides the key that the device will use to validate the action on reception of the action protocol message.

Name	ActionGroupKey
Category	ActionControl
Interface	Integer
Access	Read / Write
Unit	HexNumber
Values	0 - 4294967295 (Increment: 1)

7.1.3 ActionGroupMask

Provides the mask that the device will use to validate the action on reception of the action protocol message.

Name	ActionGroupMask
Category	ActionControl
Interface	Integer
Access	Read / Write
Unit	HexNumber
Values	0 - 4294967295 (Increment: 1)

7.1.4 ActionSelector

Selects to which Action Signal further Action settings apply.

Name	ActionSelector
Category	ActionControl
Interface	Integer
Access	Read / Write
Unit	-
Values	1 - 1 (Increment: 1)

7.2 Category: AnalogControl

Features in this chapter describes how to influence the analog features of an image, such as gain, black level, brightness correction and gamma.

7.2.1 BalanceWhiteAuto (color cameras only)

Controls the mode for automatic white balancing between the color channels. The white balancing ratios are automatically adjusted.

Name	BalanceWhiteAuto	
Category	AnalogControl	
Interface	IEnumeration	
Access	Read / Write	
Unit	-	
Values	Continuous	White balancing is constantly adjusted by the device.
	Off	White balancing is off.
	Once	White balancing is automatically adjusted once by the device. Once it has converged, it automatically returns to the Off state. The levelling can take several images.
Notice When images are acquired in trigger mode, the white balance affects on the next acquired image.		

7.2.2 BlackLevel

Controls the analog black level as an absolute physical value. This represents a DC offset applied to the video signal.

Name	BlackLevel
Category	AnalogControl
Interface	IFloat
Access	Read / Write
Unit	-
Values	see tables below (Increment: 1.00)

7.2.2.1 VCXG / .XC / .I / .I.XT / .PTP / .I.PTP

Camera Type	Black Level
Monochrome / Color	
VCXG-02M / VCXG-02C	0 ... 63 DN10
VCXG-03SWIR.XC	0 ... 255 DN12
VCXG-04M / VCXG-04C	0 ... 255 DN12
VCXG-13M / .I / .I.XT / VCXG-13C / .I / .I.XT / VCXG-13NIR	0 ... 63 DN10
VCXG-14SWIR.XC	0 ... 255 DN12
VCXG-15M / .I / .I.XT / VCXG-15C / .I / .I.XT	0 ... 255 DN12
VCXG-22M.R / VCXG-22C.R	0 ... 255 DN12
VCXG-23M / VCXG-23C	0 ... 255 DN12
VCXG-24M / VCXG-24C	0 ... 255 DN12
VCXG-25M / .I / .I.XT / VCXG-25C / .I / .I.XT	0 ... 63 DN10
VCXG-32M / .I / .I.XT / .PTP / .I.PTP	0 ... 255 DN12
VCXG-32C / .I / .I.XT / .PTP / .I.PTP	0 ... 255 DN12
VCXG-51MP	0 ... 255 DN12
VCXG-51M / .XC / .I / .I.XT / .PTP / .I.PTP	0 ... 255 DN12
VCXG-51C / .I / .I.XT / .PTP / .I.PTP	0 ... 255 DN12
VCXG-53M / .I / .I.XT / VCXG-53C / .I / .I.XT / VCXG-53NIR	0 ... 63 DN10
VCXG-65M.R / VCXG-65C.R	0 ... 255 DN12
VCXG-82M / .I / .I.XT / VCXG-82C / .I / .I.XT	0 ... 255 DN12
VCXG-91M / VCXG-91C	0 ... 255 DN12
VCXG-124M / .I / .I.XT / .PTP / .I.PTP	0 ... 255 DN12
VCXG-124C / .I / .I.XT / .PTP / .I.PTP	0 ... 255 DN12
VCXG-125M.R / VCXG-125C.R	0 ... 255 DN12
VCXG-127M / .I / .I.XT / VCXG-127C / .I / .I.XT	0 ... 255 DN12
VCXG-201M / .I / .I.XT / VCXG-201C / .I / .I.XT	0 ... 255 DN12
VCXG-204M / VCXG-204C	0 ... 255 DN12
VCXG-241M / .I / .I.XT / VCXG-241C / .I / .I.XT	0 ... 255 DN12

7.2.2.2 VCXU / .XC

Camera Type	Black Level
Monochrome / Color	
VCXU-02M / VCXU-02C	0 ... 63 DN10
VCXU-04M / VCXU-04C	0 ... 255 DN12
VCXU-13M / VCXU-13C	0 ... 63 DN10
VCXU-15M / VCXU-15C	0 ... 255 DN12
VCXU-22M.R / VCXU-22C.R	0 ... 255 DN12
VCXU-23M / VCXU-23C	0 ... 255 DN12
VCXU-24M / VCXU-24C	0 ... 255 DN12
VCXU-25M / .XC / VCXU-25C	0 ... 63 DN10
VCXU-31M / VCXU-31C	0 ... 255 DN12
VCXU-32M / VCXU-32C	0 ... 255 DN12
VCXU-50M / VCXU-50C	0 ... 255 DN12
VCXU-50MP	0 ... 255 DN12
VCXU-51M / VCXU-51C	0 ... 255 DN12
VCXU-53M / VCXU-53C	0 ... 63 DN10
VCXU-65M.R / VCXU-65C.R	0 ... 255 DN12
VCXU-90M / VCXU-90C	0 ... 255 DN12
VCXU-91M / VCXU-91C	0 ... 255 DN12

VCXU-123M / VCXU-123C	0 ... 255 DN12
VCXU-124M / VCXU-124C	0 ... 255 DN12
VCXU-125M.R / VCXU-125C.R	0 ... 255 DN12
VCXU-201M.R / VCXU-201C.R	0 ... 255 DN12

7.2.3 BlackLevelSelector

Selects which Black Level is controlled by the various Black Level features.

Name	BlackLevelSelector	
Category	AnalogControl	
Interface	IEnumeration	
Access	Read / Write	
Unit	-	
Values	All	Black Level will be applied to all channels or taps.

7.2.4 Gain

Motion blur is unacceptable in high quality image acquisition. Exposure times are therefore limited. However, this results in low output signals from the camera and dark images. To solve this issue, the signals can be amplified by a user-defined gain factor within the camera.

Notice

Increasing the gain factor also increases image noise.

Controls the selected gain as an absolute physical value.

Name	Gain
Category	AnalogControl
Interface	IIFloat
Access	Read / Write
Unit	-
Values	see tables below

7.2.4.1 VCXG / .XC / .I / .I.XT / .PTP / .I.PTP

Camera Type	Gain ¹⁾
Monochrome	
VCXG-02M	0...12 18
VCXG-03SWIR.XC	0...48
VCXG-04M	0...48
VCXG-13M / .I/.I.XT	0...12 18
VCXG-13NIR	0...18
VCXG-14SWIR.XC	0...48
VCXG-15M/ .I/.I.XT	0...48
VCXG-22M.R	0...48
VCXG-23M	0...48
VCXG-24M	0...48
VCXG-25M / .I/.I.XT	0...12 18
VCXG-32M / .I / .I.XT / .PTP / .I.PTP	0...48
VCXG-50MP	0...48
VCXG-51M / .XC / .I / .I.XT / .PTP / .I.PTP	0...48
VCXG-53M / .I/.I.XT	0...12 18
VCXG-65M.R	0...48
VCXG-82M / .I / .I.XT	0...18
VCXG-91M	0...48
VCXG-124M / .I / .I.XT / .PTP / .I.PTP	0...48
VCXG-125M.R	0...20
VCXG-127M / .I / .I.XT	0...48
VCXG-201M.R / .I / .I.XT	0...20
VCXG-204M	0...48
VCXG-241M / .I / .I.XT	0...48
Color	
VCXG-02C	0...12
VCXG-04C	0...48
VCXG-13C / .I/.I.XT	0...12
VCXG-15C/ .I/.I.XT	0...48
VCXG-22C.R	0...48
VCXG-23C	0...48
VCXG-24C	0...48
VCXG-25C / .I/.I.XT	0...12
VCXG-32C / .I / .I.XT / .PTP / .I.PTP	0...48
VCXG-51C / .I / .I.XT / .PTP / .I.PTP	0...48
VCXG-53C / .I/.I.XT	0...12
VCXG-53NIR	0...12
VCXG-65C.R	0...48
VCXG-82C / .I / .I.XT	0...18
VCXG-91C	0...48
VCXG-124C / .I / .I.XT / .PTP / .I.PTP	0...48
VCXG-125C.R	0...20
VCXG-127C / .I / .I.XT	0...48
VCXG-201C.R / .I / .I.XT	0...20
VCXG-204M	0...48
VCXG-241C / .I / .I.XT	0...48

¹⁾ Release 1.0 | ≥ Release 2.0

7.2.4.2 VCXU / .XC

Camera Type	Gain ¹⁾
Monochrome	
VCXU-02M	0...12 18
VCXU-04M	0...48
VCXU-13M	0...12 18
VCXU-15M	0...48
VCXU-22M.R	0...26
VCXU-23M	0...48
VCXU-24M	0...48
VCXU-25M / .XC	0...12 18
VCXU-31M	0...48
VCXU-32M	0...48
VCXU-50M	0...48
VCXU-50MP	0...48
VCXU-51M	0...48
VCXU-53M	0...12 18
VCXU-65M.R	0...48
VCXU-90M	0...48
VCXU-91M	0...48
VCXU-123M	0...48
VCXU-124M	0...48
VCXU-125M.R	0...20
VCXU-201M.R	0...20
Color	
VCXU-02C	0...12
VCXU-04C	0...48
VCXU-13C	0...12
VCXU-15C	0...48
VCXU-22C.R	0...26
VCXU-23C	0...48
VCXU-24C	0...48
VCXU-25C	0...12
VCXU-31C	0...48
VCXU-32C	0...48
VCXU-50C	0...48
VCXU-51C	0...48
VCXU-53C	0...12
VCXU-65C.R	0...48
VCXU-90C	0...48
VCXU-91C	0...48
VCXU-123C	0...48
VCXU-124C	0...48
VCXU-125C.R	0...20
VCXU-201C.R	0...20

¹⁾ Release 1.0 | ≥ Release 2.0

7.2.5 GainAuto (except .PTP / .I.PTP)

Sets the automatic gain control (AGC) mode. The exact algorithm used to implement AGC is device-specific.

Name	GainAuto	
Category	AnalogControl	
Interface	IEnumeration	
Access	Read / Write	
Unit	-	
Values	Continuous	Gain is constantly adjusted by the device.
	Off	Gain is User controlled using Gain.
	Once	Gain is automatically adjusted once by the device. Once it has converged, it automatically returns to the Off state. The levelling can take several images.

7.2.6 GainSelector

Selects which gain is controlled by the various gain feature.

Name	GainSelector	
Category	AnalogControl	
Interface	IEnumeration	
Access	Read / Write	
Unit	-	
Values	All	Gain will be applied to all channels or taps.
	Blue	Gain will be applied to the blue channel. (only color cameras)
	GreenBlue	Gain will be applied to the green blue channel. (only color cameras)
	GreenRed	Gain will be applied to the green red channel. (only color cameras)
	Red	Gain will be applied to the red channel. (only color cameras)

7.2.7 Gamma

This feature offer the possibility of compensating nonlinearity in the perception of light by the human eye.

For this correction, the corrected pixel intensity (Y') is calculated from the original intensity of the sensor's pixel (Y_{original}) and correction factor γ using the following formula (in over-simplified version):

$$Y' = Y_{\text{original}}^{\gamma}$$

The correction factor γ is adjustable from 0.1 to 2.

The values of the calculated intensities are entered into the Look-Up-Table. Thereby previously existing values within the LUT will be overwritten.

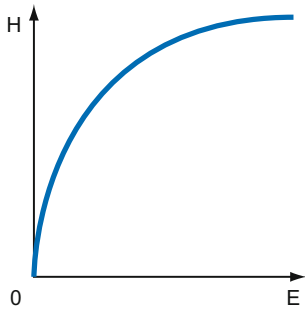

Non-linear perception of the human eye.
H - Perception of brightness
E - Energy of light

Notice

If the LUT feature is disabled on the software side, the gamma correction feature is disabled, too.

Notice

For cameras with long readout times (e.g.: VCXU-201M.R / VCXU-123M) may cause visual effects while setting a value for gamma and simultaneous image acquisition, because access to LUT is not locked against the pixel stream.

This can be prevented by stopping the camera (*AcquisitionStop*) before setting.

Name	Gamma
Category	AnalogControl
Interface	IFloat
Access	Read / Write
Unit	-
Values	0.1 - 2.0 (Increment: 0.10)

7.2.8 boBlackLevelAutoAdjustEnable (SWIR only)

Enables the black level auto adjust of the image sensor. Disable the black level auto adjust only after sufficient evaluations of the sensor-behaviour in the intended use scenario. Disabling the black level auto adjust can cause a shift of the black level to a different value than set in the feature BlackLevel.

Disabling the black level auto adjust function can be an option to mitigate issues for applications that use very long ExposureTimes and suffer from a decreased saturation level or applications that apply significant changes to *ExposureTime* in a rapid manner, especially with *TriggerMode* = On.

Name	boBlackLevelAutoAdjustEnable
Category	AnalogControl
Interface	IBoolean
Access	Read / Write
Unit	-
Values	true = 1 (On) false = 0 (Off)

7.3 Category: AutoFeatureControl (≥ Release 3 only, except .PTP / .I.PTP)

Category that contains the auto feature control features.

General Information

Various auto features are available to affect the automatic adjustment of image brightness. Two methods are described below.

BrightAutoPriority = ExposureAuto

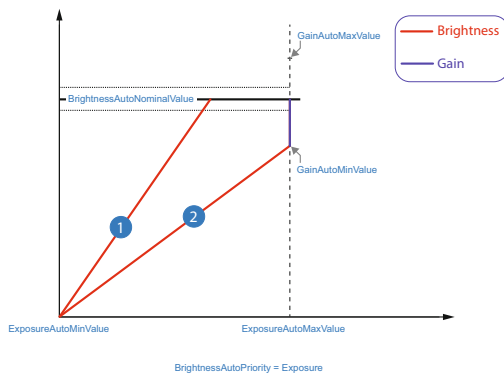

1 Example 1

For image 1, increasing the brightness with *ExposureTime* is sufficient to achieve the *BrightnessAutoNominalValue*.

2 Example 2

For image 2, increasing the brightness with *ExposureTime* is not enough to reach the value of *BrightnessAutoNominalValue*.

Therefore, the gain is increased after reaching *ExposureAutoMaxValue*.

BrightAutoPriority = GainAuto

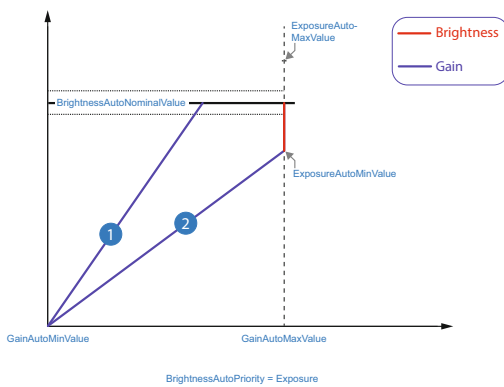

1 Example 1

For image 1, increasing the brightness with *Gain* is sufficient to achieve the *BrightnessAutoNominalValue*.

2 Example 2

For image 2, increasing the brightness with *Gain* is not enough to reach the value of *BrightnessAutoNominalValue*.

Therefore, the *ExposureTime* is increased after reaching *ExposureAutoMaxValue*.

AutoFeature ROI - General Information

You can use the AutoFeature Region of Interest (ROI) function to predefine a so-called region of interest. This ROI is an area of pixels on the sensor.

This function is used if only the image data (e.g. brightness) of a particular region of the image is of interest. The calculated corrections will be applied to the entire image.

The AutoFeature ROI is specified using four values:

- AutoFeatureOffsetX - x-coordinate of the first relevant pixel
- AutoFeatureOffsetY - y-coordinate of the first relevant pixel
- AutoFeatureWidth - horizontal size of the Region
- AutoFeatureHeight - vertical size of the Region

AutoFeature ROI in Full Frame

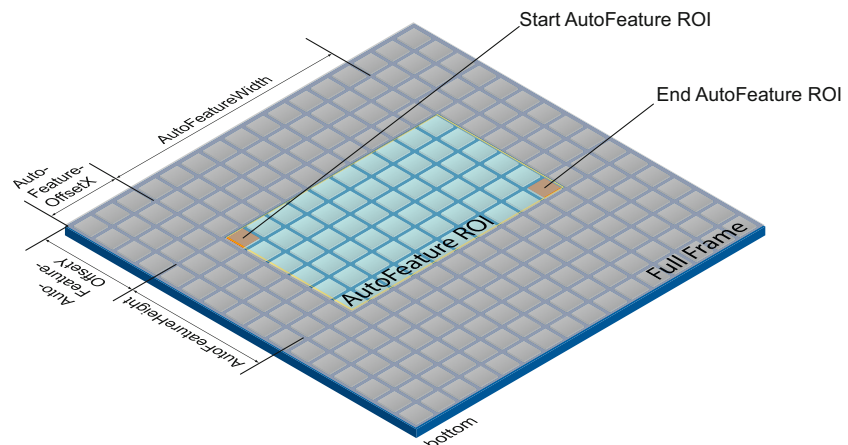

AutoFeature ROI in an ROI

Notice

It is possible to set an AutoFeature ROI in an ROI (Category: *ImageFormatControl*). The values that can be set for the AutoFeature ROI are adjusted accordingly.

The starting point for *AutoFeatureOffsetX* and *AutoFeatureOffsetY* is determined by the ROI (Category: *ImageFormatControl*).

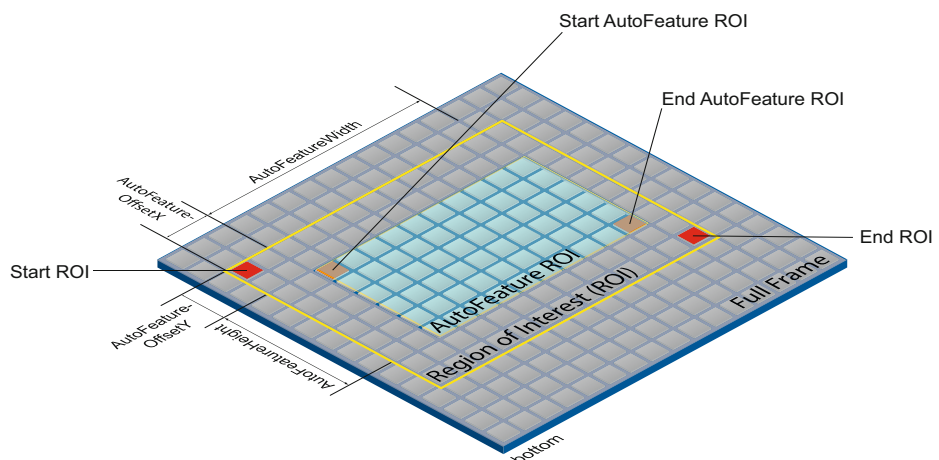

7.3.1 AutoFeatureHeight

Height of the selected Auto Feature Region (in pixels).

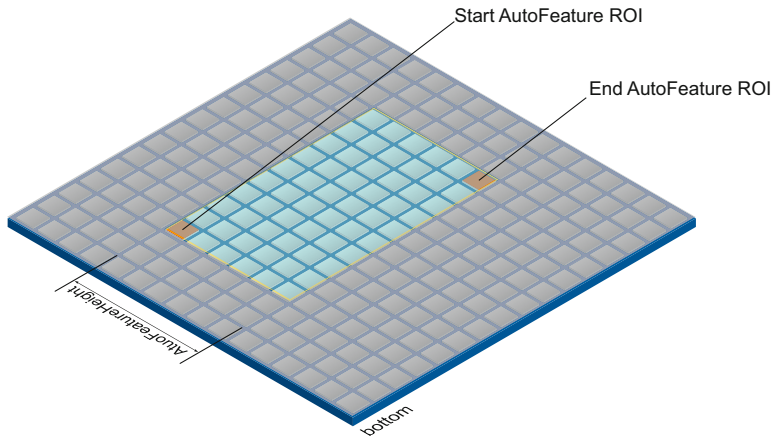

Name	AutoFeatureHeight
Category	AutoFeatureControl
Interface	Integer
Access	Read / Write
Unit	-
Values	see chapter „7.11.9 Height“ on page 158

7.3.2 AutoFeatureOffsetX

Horizontal offset from the origin to the Auto Feature Region (in pixels).

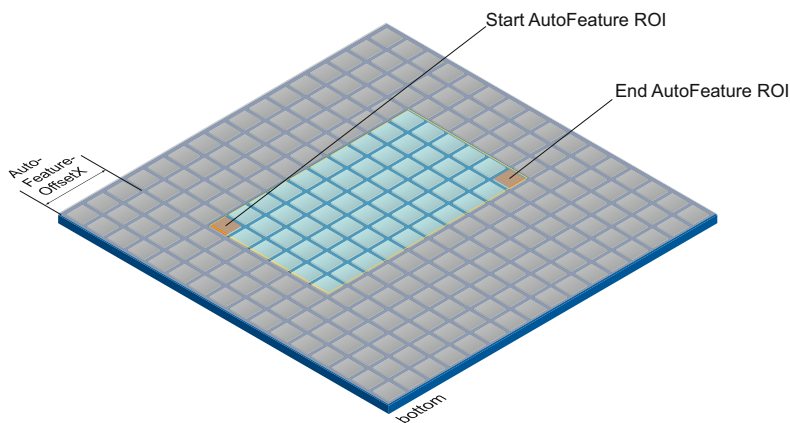

Name	AutoFeatureOffsetX
Category	AutoFeatureControl
Interface	Integer
Access	Read / Write
Unit	-
Values	0 - depends on <i>AutoFeatureWidth</i>

7.3.3 AutoFeatureOffsetY

Vertical offset from the origin to the Auto Feature Region (in pixels).

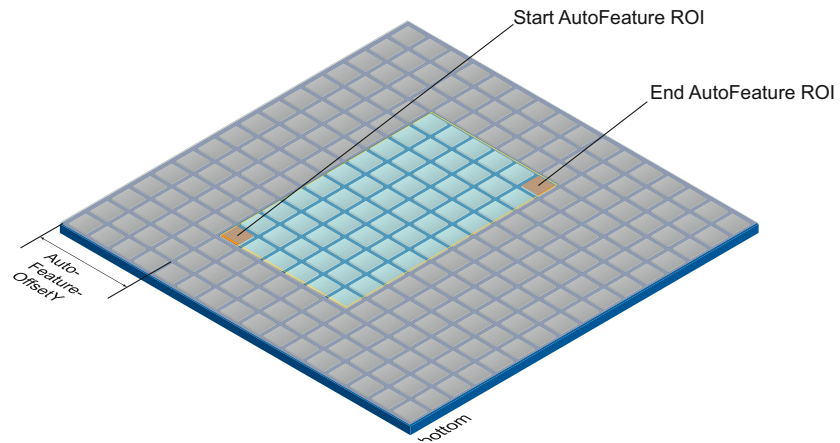

Name	AutoFeatureOffsetY
Category	AutoFeatureControl
Interface	IInteger
Access	Read / Write
Unit	-
Values	0 - depends on <i>AutoFeatureHeight</i>

7.3.4 AutoFeatureRegionMode

Controls the mode of the selected Auto Feature Region (AutoFeature ROI).

Notice

The camera must be stopped before this feature can be edited.

Name	AutoFeatureRegionMode	
Category	AutoFeatureControl	
Interface	IEnumeration	
Access	Read / Write	
Unit	-	
Values	Off	All settings of the selected AutoFeature ROI are automatically equal to the selected AutoFeatureRegionReference.
	On	The settings of the selected AutoFeature ROI are user defined. The AutoFeature is useable only if the AutoFeature ROI fits into the AutoFeatureregionReference of the AutoFeature.

7.3.5 AutoFeatureRegionReference

The Reference Region of interest. The Auto Feature Region is part of this region and all Auto Feature Region features are refs to this Reference Region.

Name	AutoFeatureRegionReference
Category	AutoFeatureControl
Interface	IEnumeration
Access	Read / Write
Unit	-
Values	Region0 The selected Auto Feature Region refs to Region 0.

7.3.6 AutoFeatureRegionSelector

Selects the Region of interest to control. The RegionSelector feature allows devices that are able to extract multiple regions out of an image, to configure the features of those individual regions independently.

Name	AutoFeatureRegionSelector
Category	AutoFeatureControl
Interface	IEnumeration
Access	Read / Write
Unit	-
Values	BalanceWhite-Auto Selected features will control the region for Balance-WhiteAuto and ColorTransformationAuto algorithm. Brightness-Auto Selected features will control the region for GainAuto and ExposureAuto algorithm.

7.3.7 AutoFeatureWidth

Width of the selected Auto Feature Region (in pixels).

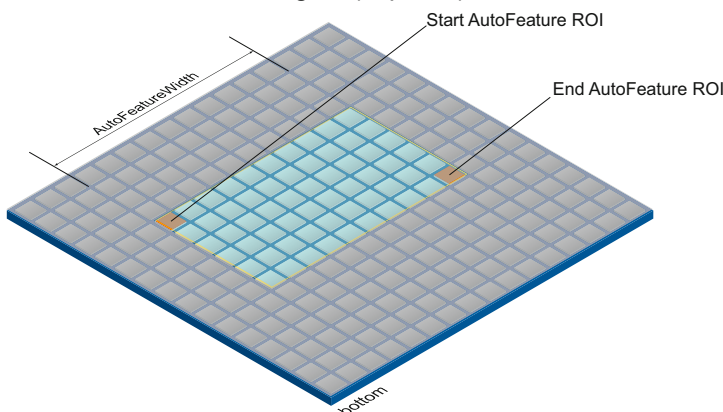

Name	AutoFeatureWidth
Category	AutoFeatureControl
Interface	IInteger
Access	Read / Write
Unit	-
Values	see chapter „7.11.24 Width“ on page 174

7.3.8 BalanceWhiteAutoStatus

Status of BalanceWhiteAuto.

Name	AutoFeatureRegionSelector	
Category	AutoFeatureControl	
Interface	IEnumeration	
Access	Read only	
Unit	-	
Values	ColorGains-TooHigh	The BalanceWhiteAuto calculation failed since at least one of the calculated color gains exceeds the maximum value.
	Initial	BalanceWhiteAuto has never been started.
	Start	BalanceWhiteAuto is waiting for statistic data.
	Success	The last BalanceWhiteAuto calculation succeeded.
	Underrun	The BalanceWhiteAuto calculation failed since at least one color-channel shows invalid statistic data.

7.3.9 BrightnessAutoNominalValue

Sets the nominal value for brightness in percent of full scale. It will be adjust with consider the setting in BrightnessAutoPriority.

Name	BrightnessAutoNominalValue
Category	AutoFeatureControl
Interface	IFloat
Access	Read / Write
Unit	%
Values	5 - 95 (Increment: 1)

7.3.10 BrightnessAutoPriority

The feature set the highest priority auto feature to adjust the brightness.

Notice

When BrightnessAutoPriority is set to GainAuto, the brightening of the image is first achieved by increasing the gain. This can cause image noise, but the frame rate is not reduced.

Name	BrightnessAutoPriority	
Category	AutoFeatureControl	
Interface	IEnumeration	
Access	Read / Write	
Unit	-	
Values	ExposureAuto	ExposureAuto has highest priority and will be modified first.
	GainAuto	GainAuto has highest priority and will be modified first.

BrightAutoPriority = ExposureAuto

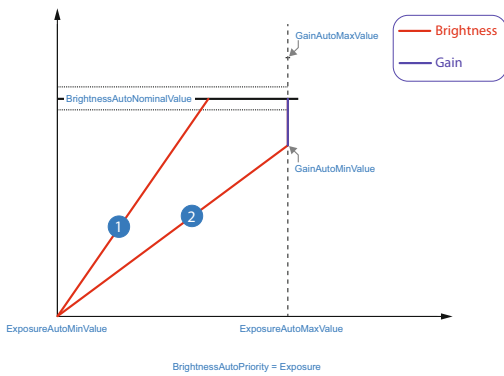

1 Example 1

For image 1, increasing the brightness with *ExposureTime* is sufficient to achieve the *BrightnessAutoNominalValue*.

2 Example 2

For image 2, increasing the brightness with *ExposureTime* is not enough to reach the value of *BrightnessAutoNominalValue*.

Therefore, the gain is increased after reaching *ExposureAutoMaxValue*.

BrightAutoPriority = GainAuto

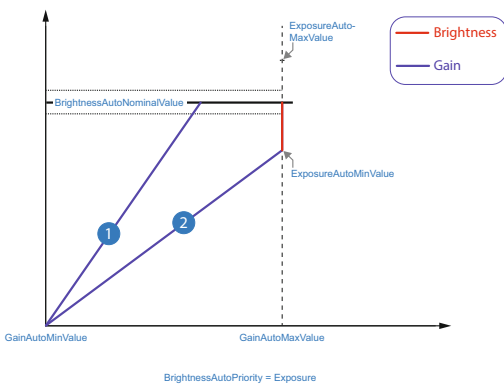

1 Example 1

For image 1, increasing the brightness with *Gain* is sufficient to achieve the *BrightnessAutoNominalValue*.

2 Example 2

For image 2, increasing the brightness with *Gain* is not enough to reach the value of *BrightnessAutoNominalValue*.

Therefore, the *ExposureTime* is increased after reaching *ExposureAutoMaxValue*.

7.3.11 ExposureAutoMaxValue

Maximal value of *ExposureTime* calculable by exposure auto algorithm.

Name	ExposureAutoMaxValue
Category	AutoFeatureControl
Interface	IFloat
Access	Read / Write
Unit	μs
Values	Adjustable value depends on the camera. see chapter „7.3.12 ExposureTime“ on page 70

7.3.12 ExposureAutoMinValue

Minimal value of ExposureTime calculable by exposure auto algorithm.

Notice

An activated *ShortExposureTimeEnable* is ignored.

Name	ExposureAutoMinValue
Category	AutoFeatureControl
Interface	IFloat
Access	Read / Write
Unit	µs
Values	Adjustable value depends on the camera. see chapter „7.3.12 ExposureTime“ on page 70

7.3.13 GainAutoMaxValue

Maximal value of Gain calculable by gain auto algorithm.

Name	GainAutoMaxValue
Category	AutoFeatureControl
Interface	IFloat
Access	Read / Write
Unit	-
Values	Adjustable value depends on the camera. see chapter „7.2.4 Gain“ on page 82

7.3.14 GainAutoMinValue

Minimal value of Gain calculable by gain auto algorithm.

Name	GainAutoMinValue
Category	AutoFeatureControl
Interface	IFloat
Access	Read / Write
Unit	-
Values	Adjustable value depends on the camera. see chapter „7.2.4 Gain“ on page 82

7.4 Category: ChunkDataControl

The chunk is a data packet that is generated by the camera and integrated into the payload (every image), if chunk mode is activated. These data include different settings for the respective image. This integrated data packet contains different image settings. Baumer GAPI can read the Image Info Header (Chunk).

There are three Chunk modes:

Image Data

Only the image data are transferred, no Chunk data.

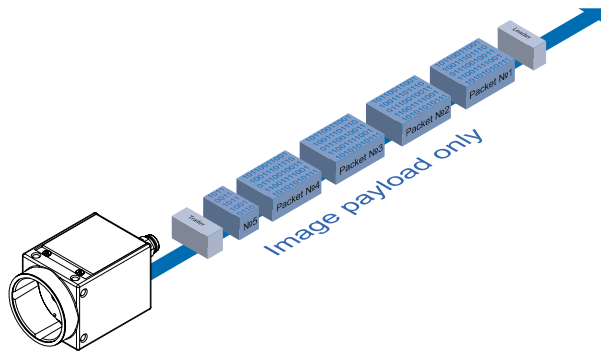

Chunk Data

Only the chunk is transferred, no image data.

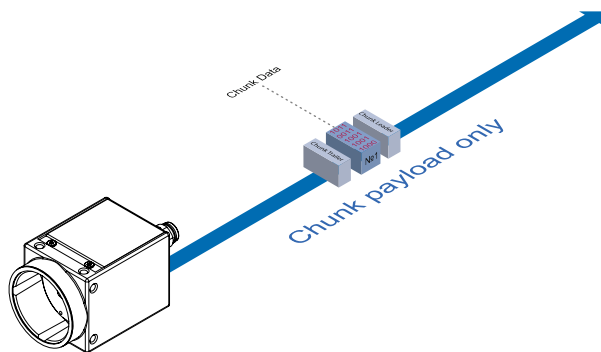

Extended Chunk Data

Chunk data and image data are transferred. The Chunk Data are included in the last data packet.

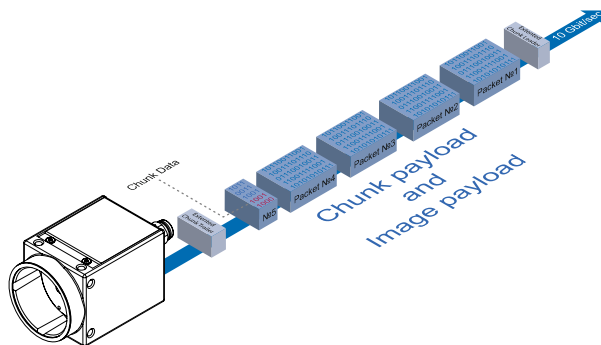

7.4.1 ChunkEnable

Enables the inclusion of the selected chunk data in the payload of the image.

Notice

You can choose the desired chunk under *Chunk Selector*.

Notice

The camera must be stopped before this feature can be edited.

Name	ChunkEnable
Category	ChunkDataControl
Interface	IBoolean
Access	Read / Write
Unit	-
Values	true = 1 (On) false = 0 (Off)

7.4.2 ChunkModeActive

Activation the inclusion of chunk data in the payload of the image.

Notice

The camera must be stopped before this feature can be edited.

Name	ChunkModeActive
Category	ChunkDataControl
Interface	IBoolean
Access	Read / Write
Unit	-
Values	true = 1 (On) false = 0 (Off)

7.4.3 ChunkSelector

Selects which chunk to enable or controlled.

Name	ChunkSelector
Category	ChunkDataControl
Interface	IEnumeration
Access	Read / Write
Unit	-
Values	see tables below

7.4.3.1 VCXG /.XC / .I / .I.XT / .PTP / .I.PTP / VCXU / .XC

This integrated data packet can contains adjustable settings for the image.

Release 1

Feature	Description
OffsetX	Horizontal offset from the origin to the area of interest (in pixels).
OffsetY	Vertical offset from the origin to the area of interest (in pixels).
Width	Returns the width of the image included in the payload.
Height	Returns the height of the image included in the payload.
PixelFormat	Returns the pixel format of the image included in the payload.
BinningHorizontal	Number of horizontal photo-sensitive cells to combine together.
BinningVertical	Number of vertical photo-sensitive cells to combine together.
ImageControl (subordinate features only together selectable)	
BrightnessCorrection	On/Off for the Brightness Correction.
DefectPixelCorrection	On/Off the correction of defect pixels.
LUTSelector	Selects the Chunk LUT.
LUTEnable	On/Off the selected LUT.
ReverseX	On/Off Flip horizontally the image sent by the device. The Region of interest is applied after the flipping
ReverseY	On/Off Flip vertically the image sent by the device. The Region of interest is applied after the flipping.
ExposureTime	Returns the exposure time used to capture the image.
BlackLevel	Returns the black level used to capture the image included in the payload.
GainSelector	Selects which Gain to retrieve data from.
Gain	Returns the gain used to capture the image.
FrameID	Returns the unique Identifier of the frame (or image) included in the payload.
Timestamp	Returns the Timestamp of the image included in the payload at the time of the FrameStart internal event.
DeviceTemperature	Device temperature in degrees Celsius (C). It is measured at the location selected by DeviceTemperatureSelector.
ChunkLineStatusAll	Returns the current status of all available Line signals at time of polling in a single bitfield.

Release 2

Feature	Description
Binning (subordinate features only together selectable)	
BinningHorizontal	Number of horizontal photo-sensitive cells to combine together.
BinningHorizontalMode	Mode of Binnings Horizontal
BinningSelector	Where the Binning is calculated. Region 0 (Binning is calculated in FPGA) Sensor (Binning is calculated in Sensor)
BinningVertical	Number of vertical photo-sensitive cells to combine together.
BinningVerticalMode	Mode of Binnings Horizontal
BlackLevel	Returns the black level used to capture the image included in the payload.
DeviceTemperature	Device temperature in degrees Celsius (C). It is measured at the location selected by DeviceTemperatureSelector.
ExposureTime	Returns the exposure time used to capture the image.
FrameID	Returns the unique Identifier of the frame (or image) included in the payload.
Gain	Returns the gain used to capture the image.
Height	Returns the height of the image included in the payload.
Image	Transmits the Image data in chunk block.
ImageControl (subordinate features only together selectable)	
BrightnessCorrection	On/Off for the Brightness Correction.
DefectPixelCorrection	On/Off the correction of defect pixels.
LUTSelector	Selects the Chunk LUT.
LUTEnable	On/Off the selected LUT.
ReverseX	On/Off Flip horizontally the image sent by the device. The Region of interest is applied after the flipping
ReverseY	On/Off Flip vertically the image sent by the device. The Region of interest is applied after the flipping.
LineStatusAll	Returns the current status of all available Line signals at time of polling in a single bitfield.
OffsetX	Horizontal offset from the origin to the area of interest (in pixels).
OffsetY	Vertical offset from the origin to the area of interest (in pixels).
PixelFormat	Returns the pixel format of the image included in the payload.
Timestamp	Returns the Timestamp of the image included in the payload at the time of the FrameStart internal event.
Width	Returns the width of the image included in the payload.

≥ Release 3

Feature	Description
Binning (subordinate features only together selectable)	
BinningHorizontal	Number of horizontal photo-sensitive cells to combine together.
BinningHorizontalMode	Mode of Binnings Horizontal
BinningSelector	Where the Binning is calculated. Region 0 (Binning is calculated in FPGA) Sensor (Binning is calculated in Sensor)
BinningVertical	Number of vertical photo-sensitive cells to combine together.
BinningVerticalMode	Mode of Binnings Horizontal
BlackLevel	Returns the black level used to capture the image included in the payload.
CounterValue	Returns the current value of the selected Counter.
DeviceTemperature	Device temperature in degrees Celsius (C). It is measured at the location selected by DeviceTemperatureSelector.
ExposureTime	Returns the exposure time used to capture the image.
FrameID	Returns the unique Identifier of the frame (or image) included in the payload.
Gain	Returns the gain used to capture the image.
Height	Returns the height of the image included in the payload.
Image	Transmits the Image data in chunk block.
ImageControl (subordinate features only together selectable)	
BrightnessCorrection	On/Off for the Brightness Correction.
DefectPixelCorrection	On/Off the correction of defect pixels.
LUTSelector	Selects the Chunk LUT.
LUTEnable	On/Off the selected LUT.
ReverseX	On/Off Flip horizontally the image sent by the device. The Region of interest is applied after the flipping
ReverseY	On/Off Flip vertically the image sent by the device. The Region of interest is applied after the flipping.
LineStatusAll	Returns the current status of all available Line signals at time of polling in a single bitfield.
OffsetX	Horizontal offset from the origin to the area of interest (in pixels).
OffsetY	Vertical offset from the origin to the area of interest (in pixels).
PixelFormat	Returns the pixel format of the image included in the payload.
SequencerSetActive	Returns the active sequencer set.
Timestamp	Returns the Timestamp of the image included in the payload at the time of the FrameStart internal event.
TriggerID (only .PTP)	Returns the Trigger ID and the Trigger Source. The Trigger ID counts the incoming triggers of the signal selected at <i>TriggerSource</i> . When the signal <i>Action1</i> is selected, the Request ID and the Source IP of the triggering device are output.
Width	Returns the width of the image included in the payload.

7.5 Category: ColorTransformationControl (color cameras only)

Category that contains the Color Transformation control features.

Oversimplified, color processing is realized by 4 modules.

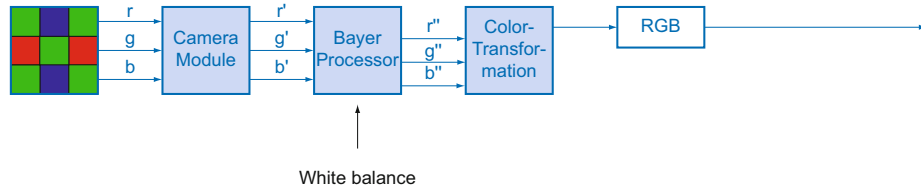

Color processing modules of color cameras.

The color signals r (red), g (green) and b (blue) of the sensor are amplified in total and digitized within the camera module.

Within the Bayer processor, the raw signals r' , g' and b' are amplified by using of independent factors for each color channel. Then the missing color values are interpolated, which results in new color values (r'' , g'' , b'').

The next step is the color transformation. Here the previously generated color signals r'' , g'' and b'' are converted to optimized RGB (Color adjustment as physical balance of the spectral sensitivities).

7.5.1 ColorTransformationAuto (≥ Release 3 only)

Controls the mode for automatic adjusting the gains of the active transformation matrix.

Notice

The *ColorTransformationAuto* feature can always be activated and the camera calculates the appropriate color matrices.

If the range of the estimated illumination to the measured reference illuminations exceeds a certain threshold, a white balance is triggered even if `BalanceWhiteAuto = off`.

However, the matrices in Image Format RAW are not used.

Notice

It is not possible to use the *Sequencer* when the feature *ColorTransformationAuto* is enabled.

Name	ColorTransformationAuto
Category	ColorTransformationControl
Interface	IEnumeration
Access	Read / Write
Unit	-

Color transformation is constantly adjusted by the device.

Values	Continuous	<p>Notice</p> <p>Color Gains not adjustable.</p>
	Off	Color transformation is user controlled using the various Colortransformation features.
	Once	Color transformation is automatically adjusted once by the device. Once it has converged, it automatically returns to the Off state.

Notice
Color Gains not adjustable.

7.5.2 ColorTransformationEnable

Activates the selected Color Transformation module.

Name	ColorTransformationEnable
Category	ColorTransformationControl
Interface	IBoolean
Access	Read only
Unit	-
Values	true = 1 (On) false = 0 (Off)

7.5.3 ColorTransformationFactoryListSelector

Selects the OptimizedMatrix for the desired color temperature. All calculated color values are based on the sRGB color space.

When setting an OptimizedMatrix, the ColorGains are also set for the white point matching the light.

Notice

We recommend to carry out a white balance after setting a matrix.

Name	ColorTransformationFactoryListSelector
Category	ColorTransformationControl
Interface	IEnumeration
Access	Read / Write
Unit	-
Values	OptimizedMatrix-For3000K Matrix is tuned to the color temperature of 3000K. OptimizedMatrix-For5000K Matrix is tuned to the color temperature of 5000K. OptimizedMatrix-For6500K Matrix is tuned to the color temperature of 6500K. OptimizedMatrix-For9500K Matrix is tuned to the color temperature of 9500K.

7.5.4 ColorTransformationOutputColorSpace

Output the color space of the camera.

Name	ColorTransformationOutputColorSpace
Category	ColorTransformationControl
Interface	IString
Access	Read only
Unit	-
Values	Color space

7.5.5 ColorTransformationResetToFactoryList

Resets the ColorTransformation to the selected ColorTransformationFactoryList.

Name	ColorTransformationResetToFactoryList
Category	ColorTransformationControl
Interface	ICommand
Access	Write only
Unit	-
Values	-

7.5.6 ColorTransformationValue

Represents the value of the selected Gain factor inside the Transformation matrix.

Name	ColorTransformationValue
Category	ColorTransformationControl
Interface	IFloat
Access	Read only
Unit	-
Values	-8.0 – 8.0 (Increment: 1.00)

7.5.7 ColorTransformationValueSelector

Selects the Gain factor of the Transformation matrix to access in the selected Color Transformation module.

Name	ColorTransformationValueSelector
Category	ColorTransformationControl
Interface	IEnumeration
Access	Read / Write
Unit	-
Values	<ul style="list-style-type: none">▪ Gain00▪ Gain01▪ Gain02▪ Gain10▪ Gain11▪ Gain12▪ Gain20▪ Gain21▪ Gain22

7.6 Category: CounterAndTimerControl

This chapter lists all features that relates to control and monitoring of Counters and Timers.

7.6.1 CounterDuration

Sets the duration (or number of events) before the CounterEnd event is generated.

When the counter reaches the CounterDuration value, a CounterEnd event is generated, the CounterActive signal becomes inactive and the counter stops counting until a new trigger happens or it is explicitly reset with CounterReset.

Name	CounterDuration
Category	CounterAndTimerControl
Interface	Integer
Access	Read / Write
Unit	-
Values	0 ... 65535 (Increment: 1)

7.6.2 CounterEventActivation

Selects the Activation mode Event Source signal.

Name	CounterEventActivation	
Category	CounterAndTimerControl	
Interface	IEumeration	
Access	Read / Write	
Unit	-	
Values	RisingEdge	Counts on the Rising Edge of the signal.
	FallingEdge	Counts on the Falling Edge of the signal.
	AnyEdge	Counts on the Falling or rising Edge of the selected signal.

7.6.3 CounterEventSource

Select the events that will be the source to increment the Counter.

Name	CounterEventSource	
Category	CounterAndTimerControl	
Interface	IEumeration	
Access	Read / Write	
Unit	-	
Values	Counter1End	Counts the number of Counter1 End.
	Counter2End	Counts the number of Counter2 End.
	ExposureActive	Counts all Exposures.
	FrameTransferSkipped	Counts when a frame transfer skipped.
	Line0	Counts the number of signals on I/O Line0.
	Line1*	Counts the number of signals on I/O Line1.
	Line2*	Counts the number of signals on I/O Line2.
	Line3**/**	Counts the number of signals on I/O Line3.
	FrameTrigger	Counts the number of Frame Start Trigger.
	Off	Disable the Counter Reset trigger.
	TriggerSkipped	Counts when a Trigger skipped.

*) ≥ Release 3

**) only VCXG.I / .XT / .PTP

7.6.4 CounterReset

Does a software reset of the selected Counter and starts it. The counter starts counting events immediately after the reset unless a Counter trigger is active. CounterReset can be used to reset the Counter independently from the CounterResetSource. To disable the counter temporarily, set CounterEventSource to Off.

Notice

Note that the value of the Counter at time of reset is automatically latched and reflected in the *CounterValueAtReset*.

Name	CounterReset
Category	CounterAndTimerControl
Interface	ICommand
Access	Write only
Unit	-
Values	-

7.6.5 CounterResetActivation

Selects the Activation mode of the Counter Reset Source signal.

Name	CounterResetActivation	
Category	CounterAndTimerControl	
Interface	IEumeration	
Access	Read / Write	
Unit	-	
Values	RisingEdge	Resets the counter on the Rising Edge of the signal.
	FallingEdge	Resets the counter on the Falling Edge of the signal.
	AnyEdge	Resets the counter on the Falling or rising Edge of the selected signal.

7.6.6 CounterResetSource

Selects the signals that will be the source to reset the Counter.

Name	CounterResetSource	
Category	CounterAndTimerControl	
Interface	IEumeration	
Access	Read / Write	
Unit	-	
Values	Counter1End	Resets with the reception of the Counter End.
	Counter2End	Resets with the reception of the Counter End.
	Line0	Resets by the I/O Line0.
	Line1*	Resets by the I/O Line1.
	Line2*	Resets by the I/O Line2.
	Line3*/**	Resets by the I/O Line3.
	Off	Disable the Counter Reset trigger.

*) ≥ Release 3

***) only VCXG.I / .XT / .PTP

7.6.7 CounterSelector

Selects which Counter to configure.

Name	CounterSelector	
Category	CounterAndTimerControl	
Interface	IEumeration	
Access	Read / Write	
Unit	-	
Values	Counter1	Selects the counter 1.
	Counter2	Selects the counter 2.

7.6.8 CounterValue

Reads or writes the current value of the selected Counter. Writing to CounterValue is typically used to set the start value.

Name	CounterValue
Category	CounterAndTimerControl
Interface	Integer
Access	Read / Write
Unit	-
Values	0 ... 65535 (Increment: 1)

7.6.9 CounterValueAtReset

Reads the value of the selected Counter when it was reset by a trigger or by an explicit CounterReset command.

It represents the last counter value latched before resetting the counter.

Name	CounterValueAtReset
Category	CounterAndTimerControl
Interface	Integer
Access	Read only
Unit	-
Values	0 ... 65535 (Increment: 1)

7.6.10 FrameCounter

The FrameCounter is part of the Baumer Image Info Header (chunk) and is added to every image if chunk mode is activated. It is generated by the hardware and can be used to verify that each of the camera's images is transmitted to the PC and received in the right order.

It is possible to set the FrameCounter to a specific value by write this value to the FrameCounter.

Name	FrameCounter
Category	CounterAndTimerControl
Interface	Integer
Access	Read / Write
Unit	-
Values	0 ... 4294967295 (Increment: 1)

7.6.11 TimerDelay

Sets the duration (in microseconds) of the delay to apply at the reception of a trigger before starting the Timer.

Name	TimerDelay
Category	CounterAndTimer
Interface	IFloat
Access	Read / Write
Unit	µs
Values	0 ... 2,000,000.000000 (Increment: 1.00)

7.6.12 TimerDuration

Sets the duration (in microseconds) of the Timer pulse.

Name	TimerDuration
Category	CounterAndTimer
Interface	IFloat
Access	Read / Write
Unit	µs
Values	10.000000 ... 2,000,000.000000 (Increment: 1.00)

7.6.13 TimerSelector

Selects which Timer to configure.

Name	TimerSelector
Category	CounterAndTimerControl
Interface	IEumeration
Access	Read / Write
Unit	-
Values	Timer1 Selects the Timer 1.

7.6.14 TimerTriggerActivation

Selects the activation mode of the trigger to start the Timer.

Name	TimerTriggerActivation	
Category	CounterAndTimerControl	
Interface	IEumeration	
Access	Read / Write	
Unit	-	
Values	RisingEdge	Starts counting on the Rising Edge of the selected trigger signal.
	FallingEdge	Starts counting on the Falling Edge of the selected trigger signal.
	AnyEdge	Starts counting on the Falling or Rising Edge of the selected trigger signal.

7.6.15 TimerTriggerSource

Selects the source of the trigger to start the Timer.

Name	TimerTriggerSource	
Category	CounterAndTimerControl	
Interface	IEumeration	
Access	Read / Write	
Unit	-	
Values	Action1 (only GigE)	Starts with the assertion of the chosen action signal.
	ExposureEnd	Starts with the reception of the Exposure End.
	ExposureStart	Starts with the reception of the Exposure Start.
	FrameTransfer-Skipped	Frame Transfer Skipped.
	Line0	Starts when the specified TimerTriggerActivation condition is met on the chosen I/O Line.
	Line1	Starts when the specified TimerTriggerActivation condition is met on the chosen I/O Line.
	Off	Disables the Timer trigger.
	Software	Starts when the trigger was generated by the software.
	TriggerSkipped	Starts when a trigger was skipped.

7.7 Category: CustomDataControl (≥ Release 3 only)

The feature contains the category of the custom data related features.

7.7.1 CustomData

The feature holds one byte of custom special data.

Name	CustomData
Category	CustomDataControl
Interface	Integer
Access	Read / Write
Unit	-
Values	0x0 ... 0xFF (Increment: 1)

7.7.2 CustomDataSelector

The feature selects the index of the custom data byte array.

Name	CustomDataSelector
Category	CustomDataControl
Interface	Integer
Access	Read / Write
Unit	-
Values	0 ... 127 (Increment: 1)

7.8 Category: DeviceControl

Category for device information and control.

7.8.1 DeviceCharacterSet

Character set used by the strings of the device's bootstrap registers.

Name	DeviceCharacterSet	
Category	DeviceControl	
Interface	IEnumeration	
Access	Read only	
Unit	-	
Values	ASCII	Device use ASCII character set.
	UTF16	Device use UTF16 character set.
	UTF8	Device use UTF8 character set.

7.8.2 DeviceEventChannelCount

Indicates the number of event channels supported by the device.

Name	DeviceEventChannelCount	
Category	DeviceControl	
Interface	Integer	
Access	Read only	
Unit	-	
Values	0 ... 4294967295 (Increment: 1)	

7.8.3 DeviceFamilyName

Identifier of the product family of the device.

Name	DeviceFamilyName	
Category	DeviceControl	
Interface	IString	
Access	Read only	
Unit	-	
Values	device family name	

7.8.4 DeviceFirmwareVersion

Version of the firmware in the device.

Name	DeviceFirmwareVersion
Category	DeviceControl
Interface	IString
Access	Read only
Unit	-
Values	e.g. CID:000057/PID:11194280

7.8.5 DeviceGenCPVersionMajor

Major version of the GenCP protocol supported by the device.

Name	DeviceGenCPVersionMajor
Category	DeviceControl
Interface	Integer
Access	Read only
Unit	-
Values	0 ... 65535 (Increment: 1)

7.8.6 DeviceGenCPVersionMinor

Minor version of the GenCP protocol supported by the device.

Name	DeviceGenCPVersionMinor
Category	DeviceControl
Interface	Integer
Access	Read only
Unit	-
Values	0 ... 65535 (Increment: 1)

7.8.7 DeviceLinkCommandTimeout

Indicates the current command timeout of the specific Link.

Name	DeviceLinkCommandTimeout
Category	DeviceControl
Interface	IFloat
Access	Read only
Unit	µs
Values	200,000.000000 (Increment: 1)

7.8.8 DeviceLinkHeartbeatMode

Activate or deactivate the Link's heartbeat.

Name	DeviceLinkHeartbeatMode	
Category	DeviceControl	
Interface	IEnumeration	
Access	Read / Write	
Unit	-	
Values	On	Enables the Link heartbeat.
	Off	Disables the Link heartbeat.

7.8.9 DeviceLinkHeartbeatTimeout

Controls the current heartbeat timeout of the specific Link.

If this time is exceeded without a read access, the camera disconnects itself to be ready for the next connection of another application, or reconnection of the restarted PC application.

The exceedance can be caused, for example, by a crashed software or a CPU overload of the PC.

Name	DeviceLinkHeartbeatTimeout
Category	DeviceControl
Interface	IFloat
Access	Read / Write
Unit	µs
Values	500,000.000000 ... 4,294,967,295,000.000000 (Increment: 1)

7.8.10 DeviceLinkSelector

Selects which Link of the device to control.

Generally, a device has only one Link that can be composed of one or many connections. But if there are many, this selector can be used to target a particular Link of the device with certain features.

Name	DeviceLinkSelector
Category	DeviceControl
Interface	IInteger
Access	Read / Write
Unit	-
Values	0 ... 0 (Increment: 1)

7.8.11 DeviceLinkSpeed

Indicates the speed of transmission negotiated on the specified link.

Name	DeviceLinkSpeed
Category	DeviceControl
Interface	Integer
Access	Read only
Unit	Bps
Values	0 ... 9223372036854775807 (Increment: 1)

7.8.12 DeviceLinkThroughputLimit

Limits the maximum bandwidth of the data that will be streamed out by the device on the selected Link. If necessary, delays will be uniformly inserted between transport layer packets in order to control the peak bandwidth.

Name	DeviceLinkThroughputLimit
Category	DeviceControl
Interface	Integer
Access	Read / Write
Unit	Bps
Values	GigE: 1250000 ... 125000000 (Increment: 1250000) USB: 1000000 ... 400000000 (Increment: 1000000)

7.8.13 DeviceManufacturerInfo

Manufacturer information about the device.

The content might look as follows:

Firmware (F) / FPGA (C) / BL3-Version (BL)

Name	DeviceManufacturerInfo
Category	DeviceControl
Interface	IString
Access	Read only
Unit	-
Values	e. g. F:00007F9A/C:0180802D/BL3.8:00000081

7.8.14 DeviceModelName

Model of the device.

Name	DeviceModelName
Category	DeviceControl
Interface	IString
Access	Read only
Unit	-
Values	model name of the camera

7.8.15 DeviceRegistersEndiannes

Endianness of the register of the device.

Name	DeviceRegistersEndianness
Category	DeviceControl
Interface	IEnumeration
Access	Read only
Unit	-
Values	Big Device registers are big Endian. Little Device registers are little Endian

7.8.16 DeviceReset

The Device Reset feature corresponds with the camera's switched on and switched off states. Using this means it is no longer necessary to disconnect the power supply.

Notice

The execution of this feature may take several seconds.

Name	DeviceReset
Category	DeviceControl
Interface	ICommand
Access	Write only
Unit	-
Values	-

7.8.17 DeviceResetToDeliveryState

By executing this feature, the camera is set to the factory settings. The settings stored in the camera (e.g. *UserSets*) will be lost.

Name	DeviceResetToDeliveryState
Category	DeviceControl
Interface	ICommand
Access	Write only
Unit	-
Values	-

7.8.18 DeviceSFNCVersionMajor

Major version of the Standard Features Naming Convention that was used to create the device's GenICam XML.

Name	DeviceSFNCVersionMajor
Category	DeviceControl
Interface	IInteger
Access	Read only
Unit	-
Values	>0

7.8.19 DeviceSFNCVersionMinor

Minor version of the Standard Features Naming Convention that was used to create the device's GenICam XML.

Name	DeviceSFNCVersionMinor
Category	DeviceControl
Interface	IInteger
Access	Read only
Unit	-
Values	>0

7.8.20 DeviceSFNCVersionSubMinor

Sub minor version of the Standard Features Naming Convention that was used to create the device's GenICam XML.

Name	DeviceSFNCVersionSubMinor
Category	DeviceControl
Interface	IInteger
Access	Read only
Unit	-
Values	>0

7.8.21 DeviceScanType

Scan type of the sensor of the device.

Name	DeviceScanType
Category	DeviceControl
Interface	IEnumeration
Access	Read only
Unit	-
Values	Areascan 2D Sensor.

7.8.22 DeviceSensorType

This feature specifies the type of the sensor.

Name	DeviceSensorType
Category	DeviceControl
Interface	IEnumeration
Access	Read only
Unit	-
Values	CCD CCD sensor. CMOS CMOS sensor.

7.8.23 DeviceSerialNumber

Device's serial number. This string is a unique identifier of the device.

Name	DeviceSerialNumber
Category	DeviceControl
Interface	IString
Access	Read only
Unit	-
Values	e.g. 1117281217

7.8.24 DeviceStreamChannelCount

Indicates the number of streaming channels supported by the device.

Name	DeviceStreamChannelCount
Category	DeviceControl
Interface	Integer
Access	Read only
Unit	-
Values	0 ... 4294967295 (Increment: 1)

7.8.25 DeviceStreamChannelEndianness

Endianness of multi-byte pixel data for this stream.

Name	DeviceStreamChannelEndianness	
Category	DeviceControl	
Interface	Enumeration	
Access	Read / Write	
Unit	-	
Values	Big	Endianness of multi-byte pixel data for this stream is big Endian.
	Little	Endianness of multi-byte pixel data for this stream is little Endian.

7.8.26 DeviceStreamChannelPacketSize

Specifies the stream packet size, in bytes, to send on the selected channel for a Transmitter or specifies the maximum packet size supported by a receiver.

Name	DeviceStreamChannelPacketSize
Category	DeviceControl
Interface	Integer
Access	Read only
Unit	Byte
Values	576 ... 9000 (Increment: 2)

7.8.27 DeviceStreamChannelSelector

Selects the stream channel to control.

Name	DeviceStreamChannelSelector
Category	DeviceControl
Interface	Integer
Access	Read / Write
Unit	-
Values	0 ... 0 (Increment: 1)

7.8.28 DeviceStreamChannelType

Reports the type of the stream channel.

Name	DeviceStreamChannelType	
Category	DeviceControl	
Interface	IEnumeration	
Access	Read only	
Unit	-	
Values	Receiver	Data stream receiver channel.
	Transmitter	Data stream transmitter channel.

7.8.29 DeviceTLType

Transport Type of the device.

Name	DeviceTLType	
Category	DeviceControl	
Interface	IEnumeration	
Access	Read only	
Unit	-	
Values	GigEVision	
	USB3Vision	

7.8.30 DeviceTLVersionMajor

Major version of the Transport Layer (GigE Vision® version) of the device.

Name	DeviceTLVersionMajor	
Category	DeviceControl	
Interface	Integer	
Access	Read only	
Unit	-	
Values	0 ... 65535 (Increment: 1)	

7.8.31 DeviceTLVersionMinor

Minor version of the Transport Layer (GigE Vision® version) of the device.

Name	DeviceTLVersionMinor	
Category	DeviceControl	
Interface	Integer	
Access	Read only	
Unit	-	
Values	0 ... 65535 (Increment: 1)	

7.8.32 DeviceTLVersionSubMinor

Minor version of the Transport Layer (GigE Vision® version) of the device.

Name	DeviceTLVersionSubMinor
Category	DeviceControl
Interface	IInteger
Access	Read only
Unit	-
Values	0 ... 9223372036854775807 (Increment: 1)

7.8.33 DeviceTemperature

Device temperature in degrees Celsius (C). It is measured at the location selected by *DeviceTemperatureSelector*.

Name	DeviceTemperature
Category	DeviceControl
Interface	IFloat
Access	Read only
Unit	° C
Values	-127.0 ... 127.0 increased resolution (SWIR only): -128.0 ... 127.9375

7.8.34 DeviceTemperatureExceeded

Returns if the device operates in critical temperature range.

Name	DeviceTemperatureExceeded
Category	DeviceControl
Interface	IBoolean
Access	Read only
Unit	-
Values	true = 1 (On) false = 0 (Off)

7.8.35 DeviceTemperatureSelector

Selects the location within the device, where the temperature will be measured.

Name	DeviceTemperatureSelector
Category	DeviceControl
Interface	IEnumeration
Access	Read / Write
Unit	-
Values	InHouse Temperature inside the camera housing. Sensor (SWIR only) Temperature of the image sensor of the camera.

7.8.36 DeviceTemperatureStatus

Returns the current temperature status of the device.

Name	DeviceTemperatureStatus	
Category	DeviceControl	
Interface	IEnumeration	
Access	Read only	
Unit	-	
Values	Exceeded	Device operates in critical temperature range.
	High	Device operates in increased temperature range.
	Normal	Device operates in normal temperature range.
	NomalToUnderrun (several models)	Device operates in critical low temperature range.

7.8.37 DeviceTemperatureStatusTransition

Temperature threshold for selected status transition in degrees Celsius (C).

Name	DeviceTemperatureStatusTransition
Category	DeviceControl
Interface	IInteger
Access	Read / Write
Unit	° C
Values	-128.0 ... 127.0 (depending on <i>DeviceTemperatureStatusTransitionSelector</i>)

7.8.38 DeviceTemperatureStatusTransitionSelector (≥ Rel. 2 only)

Selects which temperature transition is controlled by the *DeviceTemperatureStatusTransition* feature.

Name	DeviceTemperatureStatusTransitionSelector	
Category	DeviceControl	
Interface	IEnumeration	
Access	Read / Write	
Unit	-	
Values	ExceededToNormal	Temperature threshold for transition from status <i>Exceeded</i> back to status <i>Normal</i> .
	HighToExceeded	Temperature threshold for transition from status <i>High</i> to status <i>Exceeded</i> .
	NormalToHigh	Temperature threshold for transition from status <i>Normal</i> to status <i>High</i> .
	NomalToUnderrun (model dependent)	Temperature threshold for transition from status <i>Normal</i> to status <i>Underrun</i> .

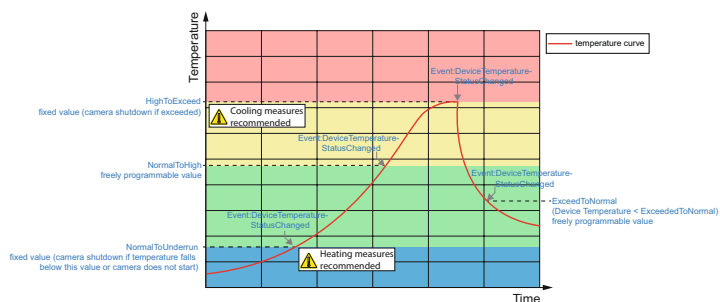

7.8.39 DeviceTemperatureUnderrun (several models)

Returns true if the device operates in critical low temperature range.

Name	DeviceTemperatureUnderrun
Category	DeviceControl
Interface	IBoolean
Access	Read only
Unit	-
Values	true = 1 (On) false = 0 (Off)

7.8.40 DeviceType

Returns the device type.

Name	DeviceType
Category	DeviceControl
Interface	IEnumeration
Access	Read only
Unit	-
Values	Transmitter Data stream transmitter device.

7.8.41 DeviceUserID

User-programmable device identifier.

Name	DeviceUserID
Category	DeviceControl
Interface	IString
Access	Read / Write
Unit	-
Values	e.g. "camera 1" (max. length 64)

7.8.42 DeviceVendorName

Name of the manufacturer of the device.

Name	DeviceVendorName
Category	DeviceControl
Interface	IString
Access	Read only
Unit	-
Values	Name of the camera manufacturer.

7.8.43 DeviceVersion

Version of the device.

Name	DeviceVersion
Category	DeviceControl
Interface	IString
Access	Read only
Unit	-
Values	e.g. R1.0.0

7.8.44 ReadOutTime

Readout time in μs for current format settings.

Notice	
Read Out Time depends on:	
▪ OffsetY	
▪ Height	
▪ PixelFormat	
▪ SensorBinning	

Name	ReadOutTime
Category	DeviceControl
Interface	IInteger
Access	Read only
Unit	μs
Values	0 ... 65535 (Increment: 1)

7.8.45 TimestampLatch

Latches the current timestamp counter into *TimestampLatchValue*.

Name	TimestampLatch
Category	DeviceControl
Interface	ICommand
Access	Write only
Unit	-
Values	-

7.8.46 TimestampLatchValue

Returns the latched value of the timestamp counter.

Name	TimestampLatchValue
Category	DeviceControl
Interface	IInteger
Access	Read only
Unit	ns
Values	≥ 0 (Increment: 8 (GigE) / 10 (USB))

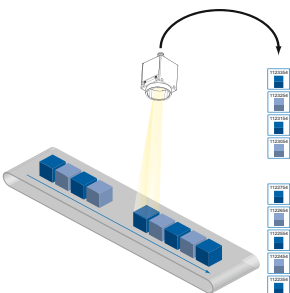

7.8.47 TimestampLatchValuePtpDays

The feature returns the latched value of the Ptp timestamp in days since 01.01.1970 00:00:00.

Name	TimestampLatchValuePtpDays
Category	DeviceControl
Interface	IInteger
Access	Read only
Unit	-
Values	0 ... 9223372036854775807 (Increment: 1)

7.8.48 TimestampReset

Resets the current value of the device timestamp counter.

Name	TimestampReset
Category	DeviceControl
Interface	ICommand
Access	Write only
Unit	-
Values	-

7.8.49 USB2SupportEnable

Enable or disable the streaming support for USB 2.0.

Caution

If the camera is connected to an USB 2.0 port image transmission is disabled by default. The camera consumes more than 2.5W which is the maximum allowed by the USB 2.0 specification. But there is a possibility to activate the image transmission at your own risk!

This activation could damage your computer's hardware!



Procedure

1. Open the camera in the *Camera Explorer*.
2. Select the Profile *GenICam Guru*.
3. Activate the Feature *USB2 Support Enable* in the category *Device Control*.
4. Disconnect the data connection of the camera to the USB 2.0 port.
5. Connect the data connection of the camera to the USB 2.0 port.
6. Images will be transmitted via the USB 2.0 port.

Name	USB2SupportEnable
Category	DeviceControl
Interface	IBoolean
Access	Read / Write
Unit	-
Values	true = 1 (On) false = 0 (Off)

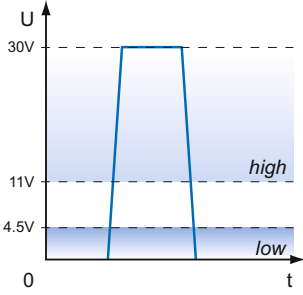

7.9 Category: DigitalIOControl

The Digital I/O chapter covers the features required to control the general Input and Output signals of the device.

Trigger

Trigger signals are used to synchronize the camera exposure and a machine cycle or, in case of a software trigger, to take images at predefined time intervals.

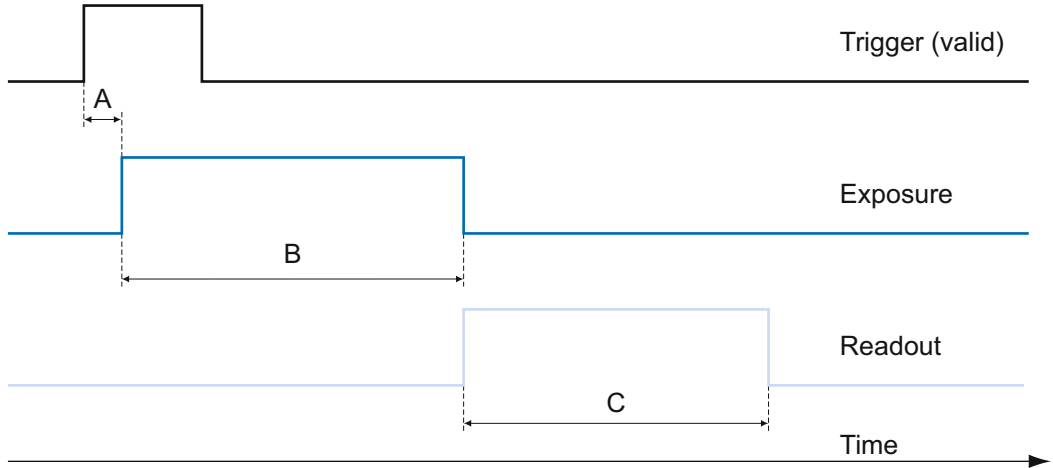

- A - Trigger delay
- B - Exposure time
- C - Readout time

Different trigger sources can be used here.

Trigger Delay:

The trigger delay is a flexible user-defined delay between the given trigger impulse and the image capture. The delay time can be set between 0.0 μ s and 2.0 s in increments of 1 μ s. Where there are multiple triggers during the delay, the triggers will also be stored and delayed. The buffer is able to store up to 512 trigger signals during the delay.

Your benefits:

- No need for an external trigger sensor to be perfectly aligned
- Different objects can be captured without hardware changes

Trigger Source (Examples of possible trigger sources)

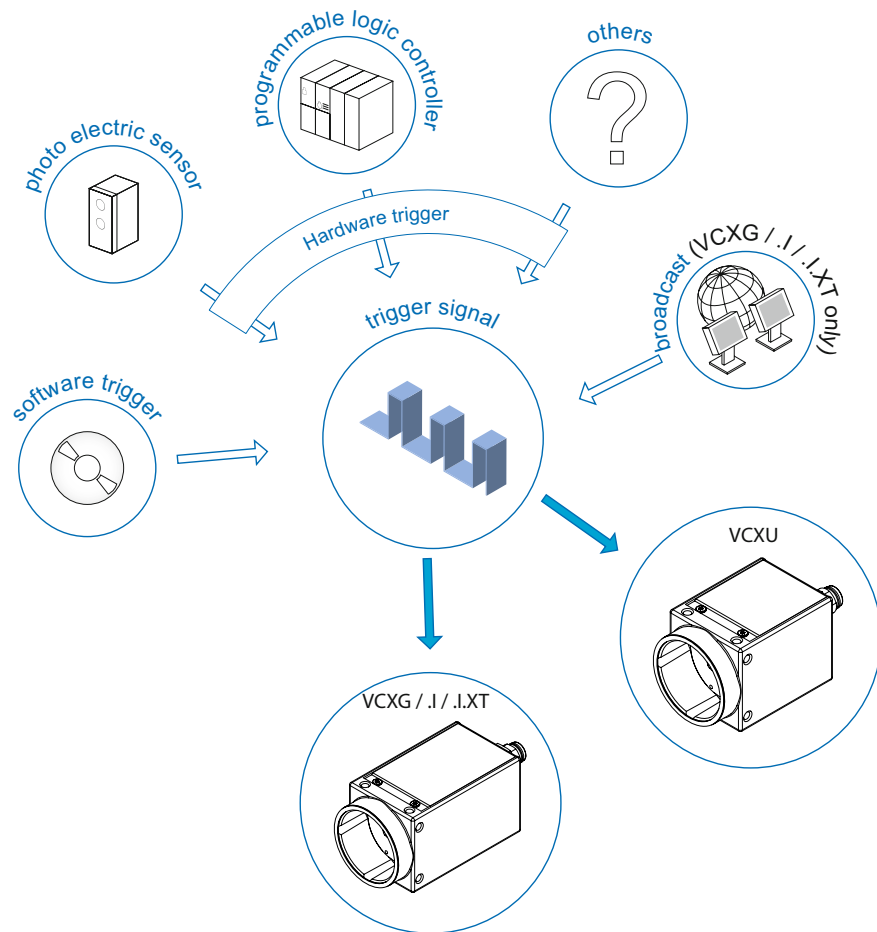

Each trigger source must be activated separately. When the trigger mode is activated, the hardware trigger is activated by default.

Debouncer (LineDebouncerHighTimeAbs / LineDebouncerLowTimeAbs)

The basic idea behind this features was to separate interfering signals (short peaks) from valid square wave signals, which can be important in industrial environments. Debouncing means that invalid signals are filtered out, and signals lasting longer than a user-defined testing time $t_{\text{DebounceHigh}}$ will be recognized and routed to the camera to induce a trigger.

In order to detect the end of a valid signal and filter out possible jitters within the signal, a second testing time $t_{\text{DebounceLow}}$ was introduced. The timing for this can also be adjusted by the user. If the signal value falls to state low and does not rise within $t_{\text{DebounceLow}}$, this is recognized as the end of the signal.

The debouncing times $t_{\text{DebounceHigh}}$ and $t_{\text{DebounceLow}}$ are adjustable from 0 to 5 ms in increments of 1 μs .

Notice

Please note that the edges of valid trigger signals are shifted by $t_{\text{DebounceHigh}}$ and $t_{\text{DebounceLow}}$.

Depending on these two timings, the trigger signal may be temporally stretched or compressed.

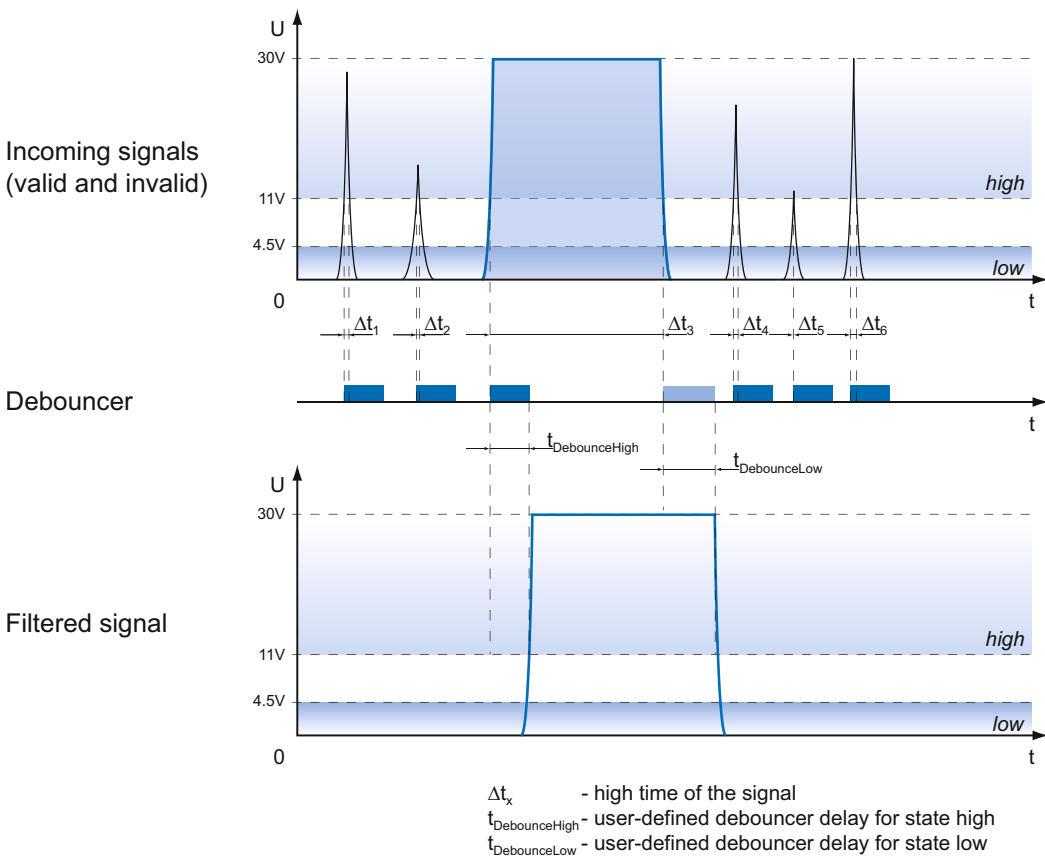

7.9.1 LineDebouncerHighTimeAbs

Sets the absolute value of the selected line debouncer time in microseconds for switch from low to high.

Name	LineDebouncerHighTimeAbs
Category	DigitalIOControl
Interface	IFloat
Access	Read / Write
Unit	µs
Values	0.000000 - 5,000.000000 (Increment: 1.00)

7.9.2 LineDebouncerLowTimeAbs

Sets the absolute value of the selected line debouncer time in microseconds for switch from high to low.

Name	LineDebouncerLowTimeAbs
Category	DigitalIOControl
Interface	IFloat
Access	Read / Write
Unit	µs
Values	0.000000 - 5,000.000000 (Increment: 1.00)

7.9.3 LineFormat (only VCXG.I / .XT / .PTP)

Controls the current electrical format of the selected physical input or output Line.

By switching the LineFormat, the behavior of the outputs can be adapted to the respective installation.

Notice

In all modes the supply voltage for the outputs (Pin 11, 12) must be connected!

Name	LineFormat
Category	DigitalIOControl
Interface	IEnumeration
Access	Read / Write
Unit	-
Values	see table below

The following line formats are available for each of the 4 outputs:

Modes	Description	Circuit
Push-Pull	<p>This mode is used to generate sharp edges for fast switching processes.</p> <p><u>Advantage:</u> Sharp edges in both directions.</p> <p><u>Disadvantage:</u> For long cable more susceptible to ground bounce and potential differences.</p>	
Open-Source	<p>Typical applications for this mode are: PLC input, control of illumination connected to ground.</p> <p><u>Advantage:</u> Stable at long cable lengths and potential differences.</p> <p><u>Disadvantage:</u> The falling edge has a lower slope due to parasitic capacitances. Switching off is slower due to this lower slope.</p>	
Open-Drain	<p>A typical case of application for this mode is a illumination control connected to plus.</p> <p><u>Advantage:</u> Stable at long cable lengths and potential differences.</p> <p><u>Disadvantage:</u> The rising edge has a lower slope due to parasitic capacitances. Switching off is slower due to this lower slope.</p>	
Tri-State	<p>In this mode, the output is disabled.</p>	

7.9.4 LineInverter

Controls the inversion of the signal of the selected input or output Line.

Name	LineInverter
Category	DigitalIOControl
Interface	IBoolean
Access	Read / Write
Unit	-
Values	true = 1 (On) false = 0 (Off)

7.9.5 LineMode

Controls if the physical Line is used to Input or Output a signal.

Name	LineMode
Category	DigitalIOControl
Interface	IEnumeration
Access	Read only
Unit	-
Values	Input The selected physical line is used to Input an electrical signal. Output The selected physical line is used to Output an electrical signal.

7.9.6 LinePWMConfigurationMode (only VCXG.I / .XT / .PTP)

Activates the Features *LinePWMMaxDuration* and *LinePWMMaxDutyCycle*.

Name	LinePWMConfigurationMode	
Category	DigitalIOControl	
Interface	IEnumeration	
Access	Read / Write	
Unit	-	
Values	Off	Disables the line PWM configuration mode.
	On	Enables the line PWM configuration mode.

With the function *Pulse Width Modulated Outputs (PWM)* it is possible to control an illumination controller or an illumination directly connected to the camera in various ways. The set LineSource is used as a signal for the control.

⚠ Caution

Erroneous settings can destroy the illumination! The outputs of the camera are protected against destruction. Please follow the information in the data sheets for your illumination. Contact the manufacturer of the illumination if you are unsure about admissible parameters.

Setting a output to a specific illumination

1. Set *LinePWMConfigurationMode* to *true*
2. Set at *LinePWMMaxDutyCycle* and *LinePWMMaxDuration* the maximum admissible parameters of your illumination (e.g. Falcon FLDR-i90B-IR24).
LinePWMMaxDutyCycle = 10 %
LinePWMMaxDuration = 10 ms
3. Set *LinePWMConfigurationMode* to *false*.

→ The values set in step 2 are now the max. admissible parameters.



Electrical specifications (Output Line4 ... Line7)

⚠ Danger!	
	Use in wet environments requiring IP67 protection
	Risk of electric shock. Electric shock can be fatal or cause serious injury.
	Use is only permitted under consideration of pollution degree 2 and overvoltage category 2.
	The M12 connectors must comply with the IEC 61076-2-101 standard.
The dielectric strength and withstand voltage for the plug/socket combination must be checked according to DIN EN 60664-1:2008-01 for 60 V.	

Electrical specifications (Output Line4 ... Line7)

U_{EXT} :	12 V - 20 % ... 48 V + 10 % DC
I_{OUT} :	- max. 1.5 A permanently in sum or per output individually
	- Pulse 40 % of the period, max. 2.5 A (t_{ON} max 1 s)
	- $t_{ON} = < 0.2 \mu s$ / $t_{OFF} = < 0.2 \mu s$
	- max. Frequency: 500 kHz

Notice

In case of overload or short circuit, the outputs are disabled. To re-enable the output, disconnect Power (IO) (pin 12) from the power supply or perform a *DeviceReset*.

7.9.7 LinePWMDuration (only VCXG.I / .XT / .PTP)

Sets the pulse time in μs , with which the illumination is pulsed.

Name	LinePWMDuration
Category	DigitalIOControl
Interface	Integer
Access	Read / Write
Unit	μs
Values	1 - 5000 (Increment: 1)

7.9.8 LinePWMDutyCycle (only VCXG.I / .XT / .PTP)

Sets the duty cycle (ratio of pulse duration to period time duration) in %. This value is specified by the connected illumination.

Name	LinePWMDutyCycle
Category	DigitalIOControl
Interface	Integer
Access	Read / Write
Unit	%
Values	1 - 100 (Increment: 1)

7.9.9 LinePWMMaxDuration (only VCXG.I / .XT / .PTP)

Sets the maximum possible *LinePWMDuration* time in μ s. This value is specified by the connected lighting.

Name	LinePWMMaxDuration
Category	DigitalIOControl
Interface	Integer
Access	Read / Write
Unit	μ s
Values	1 - 50000 (Increment: 1)

7.9.10 LinePWMMaxDutyCycle (only VCXG.I / .XT / .PTP)

Sets the maximum possible *LinePWMDutyCycle* in %. This value is specified by the connected illumination.

Name	LinePWMMaxDutyCycle
Category	DigitalIOControl
Interface	Integer
Access	Read / Write
Unit	%
Values	1 - 100 (Increment: 1)

7.9.11 LinePWMMode (only VCXG.I / .XT / .PTP)

Selects the PWM mode of the selected output line.

Name	LinePWMMode	
Category	DigitalIOControl	
Interface	IEnumeration	
Access	Read / Write	
Unit	-	
Values	Fixed Frequency	The selected output line generate a fixed frequency of pulses starting with every transition from 0 to 1 and stopping with every transition from 1 to 0.
	Off	The PWM Mode is off. The output line acts as a normal output.
	OnePulse	The selected output line generate one pulse with every transition from 0 to 1.

Timing diagrams of the PWM Modes:

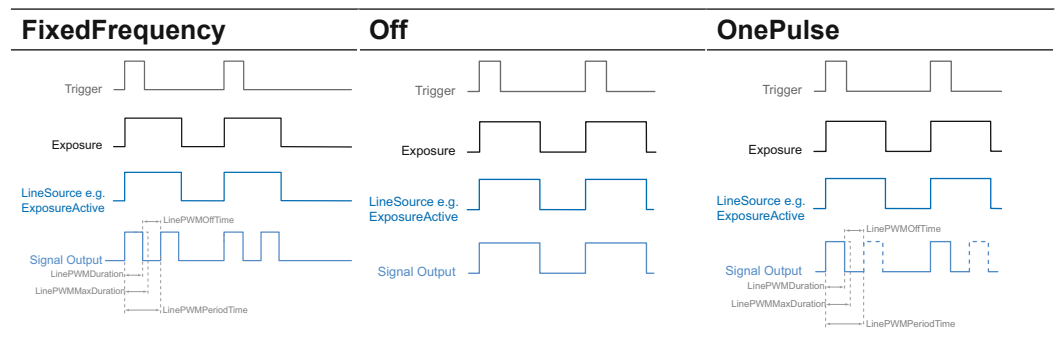

7.9.12 LinePWMOFFTime (only VCXG.I / .XT / .PTP)

Offers the off time included in the PWM Period in microseconds.

Name	LinePWMMaxDutyCycle
Category	DigitalIOControl
Interface	Integer
Access	Read only
Unit	μ s
Values	-9223372036854775808 - 9223372036854775808 (Increment: 1)

7.9.13 LinePWMPeriodTime (only VCXG.I / .XT / .PTP)

Readout of the entire period in μ s.

Name	LinePWMPeriodTime
Category	DigitalIOControl
Interface	Integer
Access	Read only
Unit	μ s
Values	depends on PWM settings

7.9.14 LineSelector

Selects the physical line (or pin) of the external device connector to configure.

Name	LineSelector
Category	DigitalIOControl
Interface	IEnumeration
Access	Read / Write
Unit	-
Values	see table below

	VCXG / .XC	VCXG.I/.I.XT/.PTP	VCXU / .XC
Line0	■	■	■
Line1	■ (GPIO)	■	■ (GPIO)
Line2	■ (GPIO)	■	■ (GPIO)
Line3	■	■	■
Line4	□	■	□
Line5	□	■	□
Line6	□	■	□
Line7	□	■	□

7.9.14.1 General Purpose Input/Output - GPIO (except VCXG.I/I.XT/PTP)

Lines 1 and 2 are GPIOs and can be inputs and outputs.

Used as an input: (0 ... 0.8 V low, 2.0 ... 3.0 V high).

Used as an output: (0 ... 0.4 V low, 2.4 ... 3.3 V high),
@ 1 mA load (high) / 50 mA sink (low)

Caution

The General Purpose IOs (GPIOs) are not potential-free and do not have an overrun cut-off. Incorrect wiring (overvoltage, undervoltage or voltage reversal) can lead to defects within the electronics system.



GPIO Power V_{CC} : 3.3 V DC
Load resistor for TTL-High-Level: approx. 2.7 k Ω

The GPIOs are configured as an input through the default camera settings. They must be connected to GPIO_GND if not used or not configured as an output. The configuration as output by default (stored in a user set) is possible with cameras \geq Release 3.

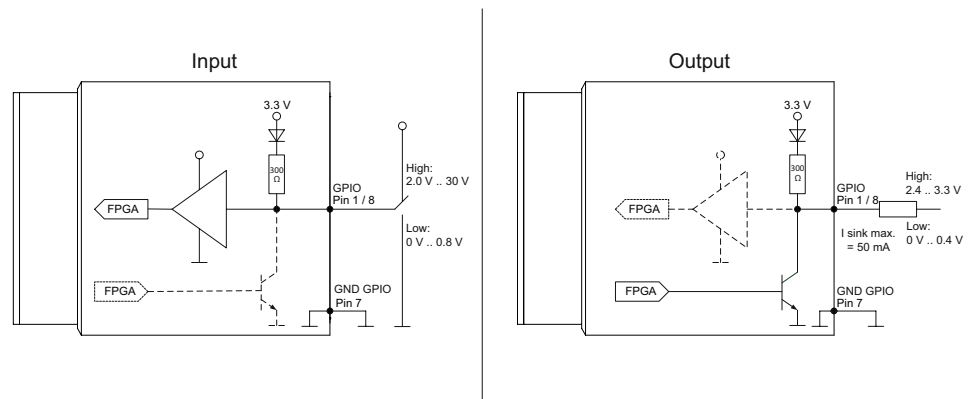

7.9.15 LineSource

With this feature, Baumer gives you the option to wire the output connectors to internal signals that are controlled on the software side.

On CX cameras, the output connector can be wired to one of the provided internal signals:

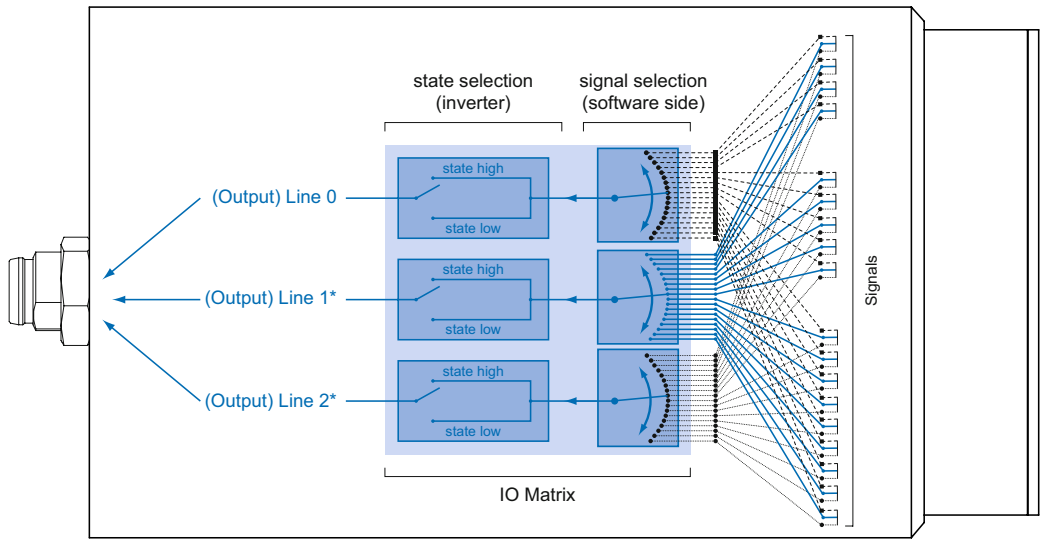

* Example, if the two GPIO's are used as outputs. (only VCXG / VCXU)

* VCXG.I / VCXG.I.XT is equipped with four fixed Outputs (Line0 ... Line3)

Name	LineSource
Category	DigitalIOControl
Interface	IEnumeration
Access	Read / Write
Unit	-
Values	see table below

Signals	
ExposureActive	Device is doing the exposure of a Frame (or Line).
Off	Line output is disabled (Tri-State).
Line 0	Device is currently waiting for signal of input line 0.
Line 1	Device is currently waiting for signal of input line 1.
ReadoutActive	Device is doing the readout of a Frame.
Timer1Active	The chosen Timer is in active state.
TriggerReady	Device is ready for trigger.
UserOutput1	The chosen User Output Bit state as defined by its current UserOutputValue.
UserOutput2 (only ≥ Rel. 2)	The chosen User Output Bit state as defined by its current UserOutputValue.
UserOutput3 (only ≥ Rel. 2)	The chosen User Output Bit state as defined by its current UserOutputValue.
UserOutput4 (only VCXG.I / .XT / .PTP)	The chosen User Output Bit state as defined by its current UserOutputValue.

ExposureActive

This signal is managed by exposure of the sensor.

Furthermore, the falling edge of the ExposureActive signal can be used to trigger a movement of the inspected objects. Due to this fact, the span time used for the sensor readout t_{readout} can be used optimally in industrial environments.

Depending on Sensor Shutter Mode (only cameras with Rolling Shutter sensors), the ExposureActive signal is active at different times.

Sensor Shutter Mode: Global Reset

Notice

In Sensor Shutter Mode: Global Reset $t_{\text{TriggerDelay}}$ is constant and independent of image settings.

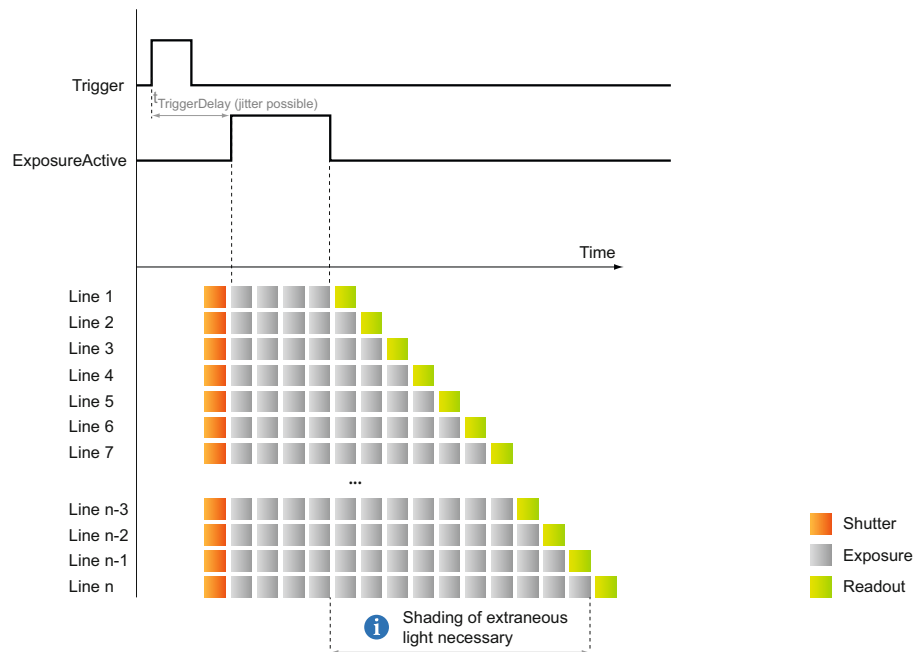

Sensor Shutter Mode: Rolling Shutter

Notice

In Sensor Shutter Mode: Rolling Shutter $t_{\text{TriggerDelay}}$ is not constant (expect $t_{\text{exposure}} < t_{\text{readout}}$).

$t_{\text{TriggerDelay}}$ depends on image settings like:

- ExposureTime
- PixelFormat
- ...

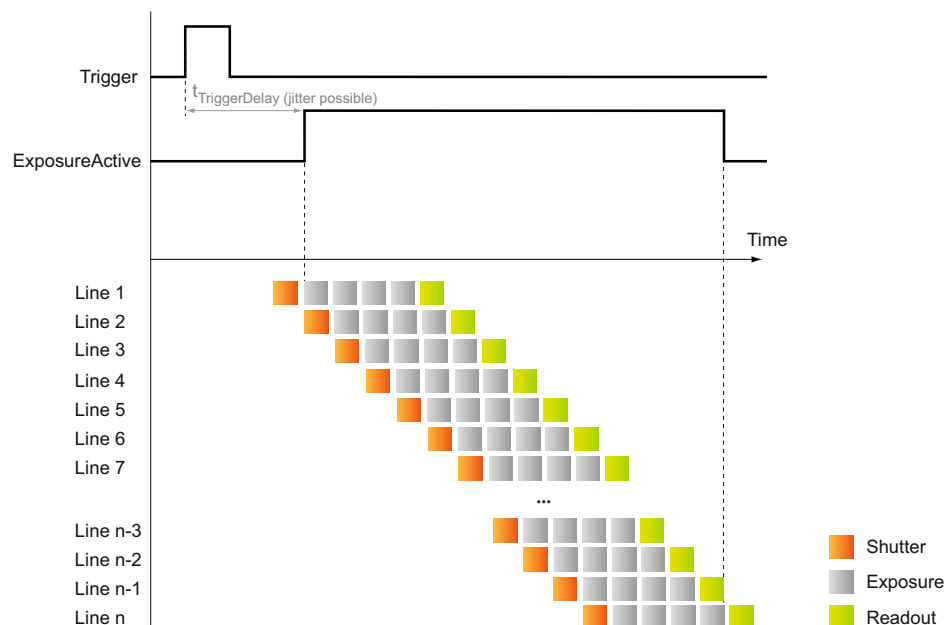

7.9.16 LineStatus

Returns the current status of the selected input or output Line.

Name	LineStatus
Category	DigitalIOControl
Interface	IBoolean
Access	Read only
Unit	-
Values	true = 1 (On) false = 0 (Off)

7.9.17 LineStatusAll

Returns the current status of all available Line signals at time of polling in a single bitfield.

Name	LineStatusAll
Category	DigitalIOControl
Interface	IInteger
Access	Read only
Unit	-
Values	Devices-Specific (HexNumber)

7.9.18 UserOutputSelector

Selects which bit of the User Output register will be set by UserOutputValue.

Name	UserOutputSelector
Category	DigitalIOControl
Interface	IEnumeration
Access	Read / Write
Unit	-
Values	UserOutput1 Selects the bit 0 of the User Output register. UserOutput2 Selects the bit 1 of the User Output register. UserOutput3 Selects the bit 2 of the User Output register. UserOutput4 Selects the bit 3 of the User Output register.

7.9.19 UserOutputValue

Sets the value of the bit selected by *UserOutputSelector*.

Name	UserOutputValue
Category	DigitalIOControl
Interface	IBoolean
Access	Read / Write
Unit	-
Values	true = 1 (On) false = 0 (Off)

7.9.20 UserOutputValueAll

Sets the value of all the bits of the User Output register.

Name	UserOutputValueAll
Category	DigitalIOControl
Interface	IInteger
Access	Read only
Unit	-
Values	0 ... 4294967295 (Increment: 1)

7.10 Category: EventControl

This chapter describes how to control the generation of Events to the host application. An Event is a message that is sent to the host application to notify it of the occurrence of an internal event.

General Information

The asynchronous message channel is described in the GigE Vision® standard and offers the possibility of event signaling. There is a timestamp (64 bits) for each announced event, which contains the accurate time the event occurred. Each event can be activated and deactivated separately.

Each event can be activated and deactivated separately (*EventSelector*).

The charts below show some timings for the event signaling by the asynchronous message channel. Vendor-specific events are explained.

EventLost

This signal can be put out when a selected event was lost. The cause may be that too many events occur.

TriggerReady

This event signals whether the camera is able to process incoming trigger signals or not.

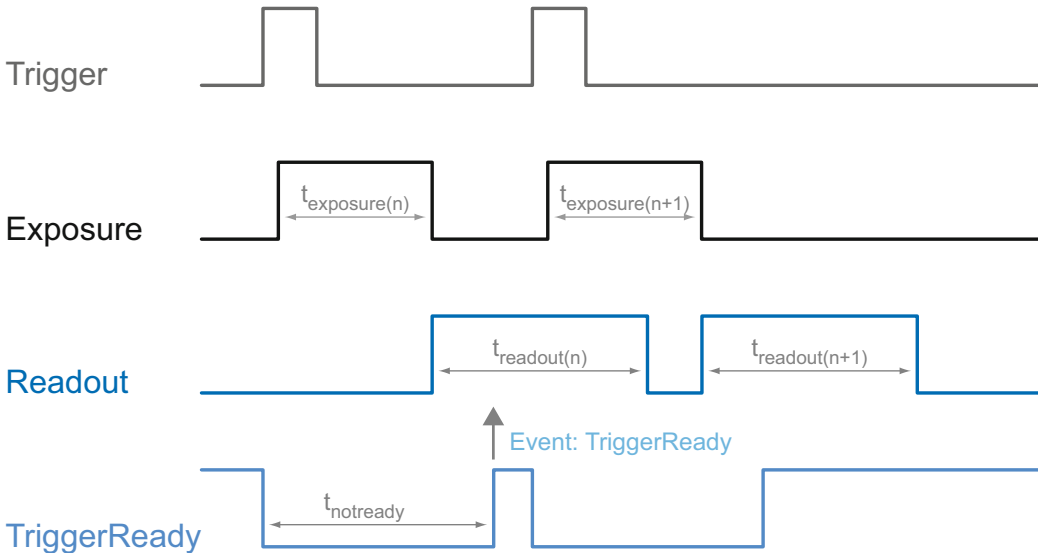

TriggerSkipped

If the camera is unable to process incoming trigger signals, which means the camera should be triggered within the interval t_{notready} , these triggers are skipped. On Baumer CX cameras the user will be informed about this fact by means of the event "TriggerSkipped".

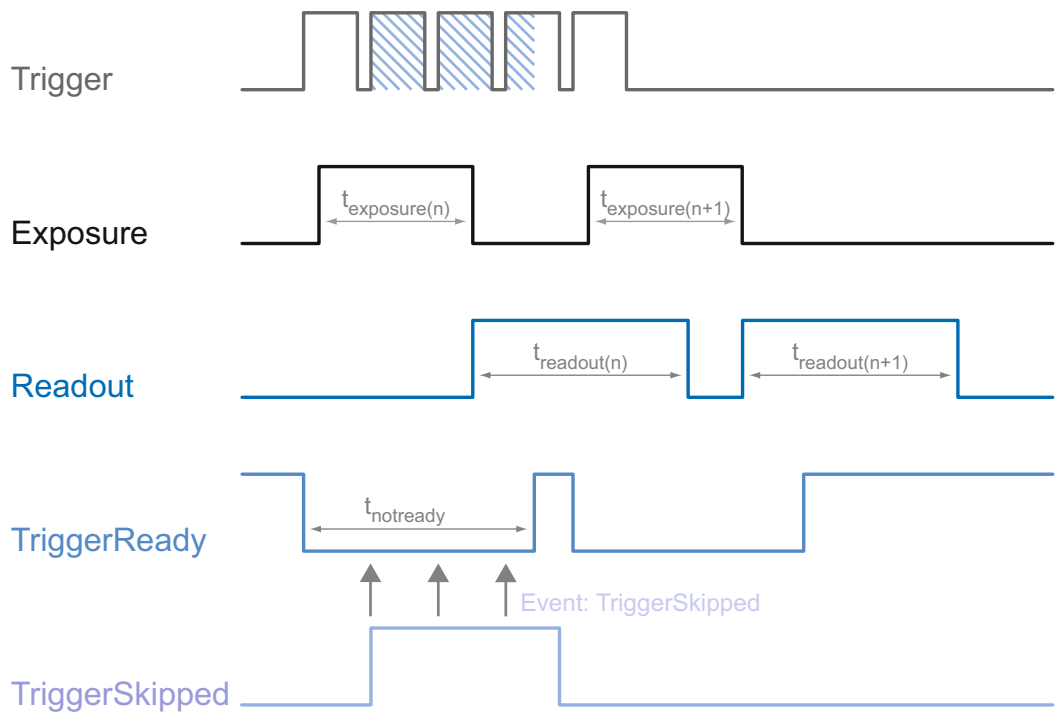

TriggerOverlapped

This signal is active, as long as the sensor is exposed and read out at the same time, which means the camera is operated overlapped.

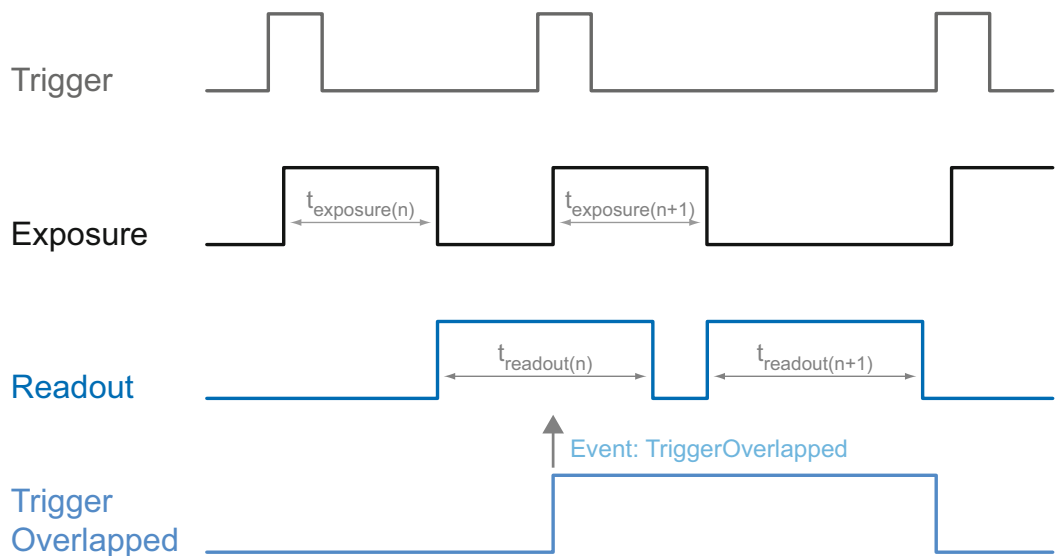

Once a valid trigger signal occurs not within a readout, the "TriggerOverlapped" signal changes to state low.

ReadoutActive

While the sensor is read out, the camera signals this by means of "ReadoutActive".

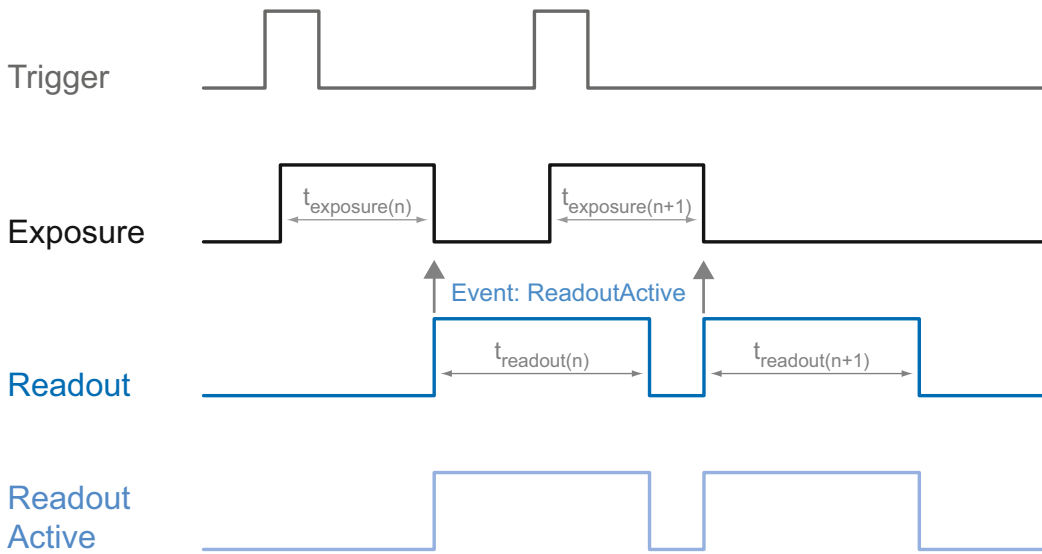

TransferBufferFull

This event is issued only in trigger mode. It signals that no buffer is available.

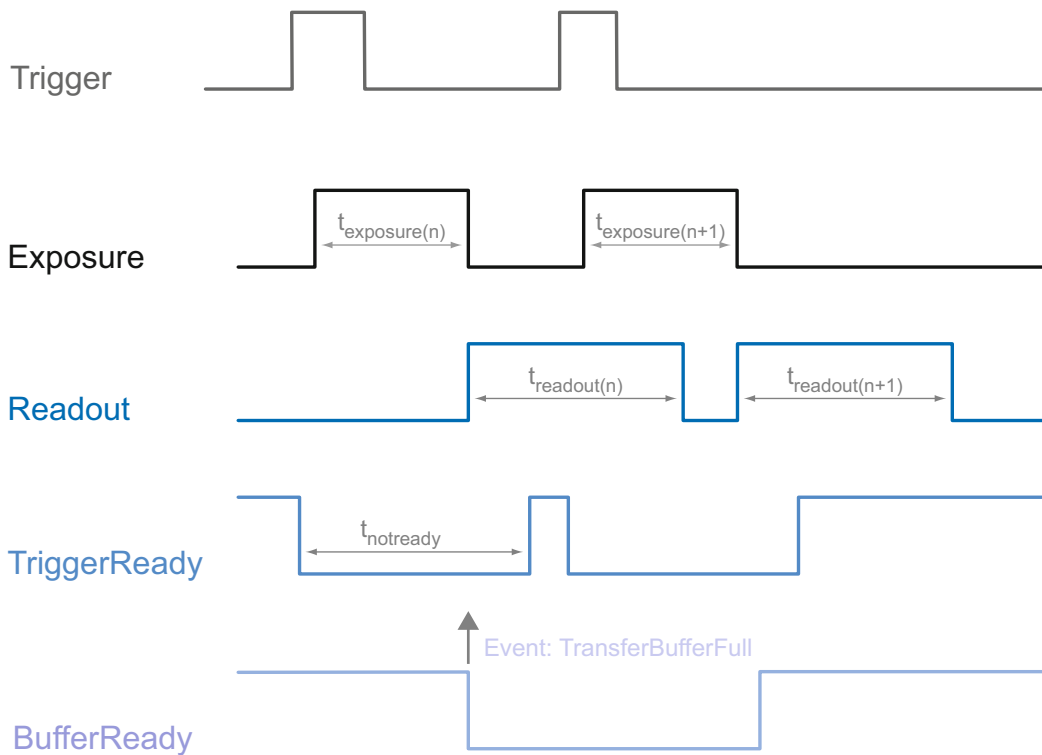

TransferBufferReady

This event is issued only in trigger mode. It signals that buffer available.

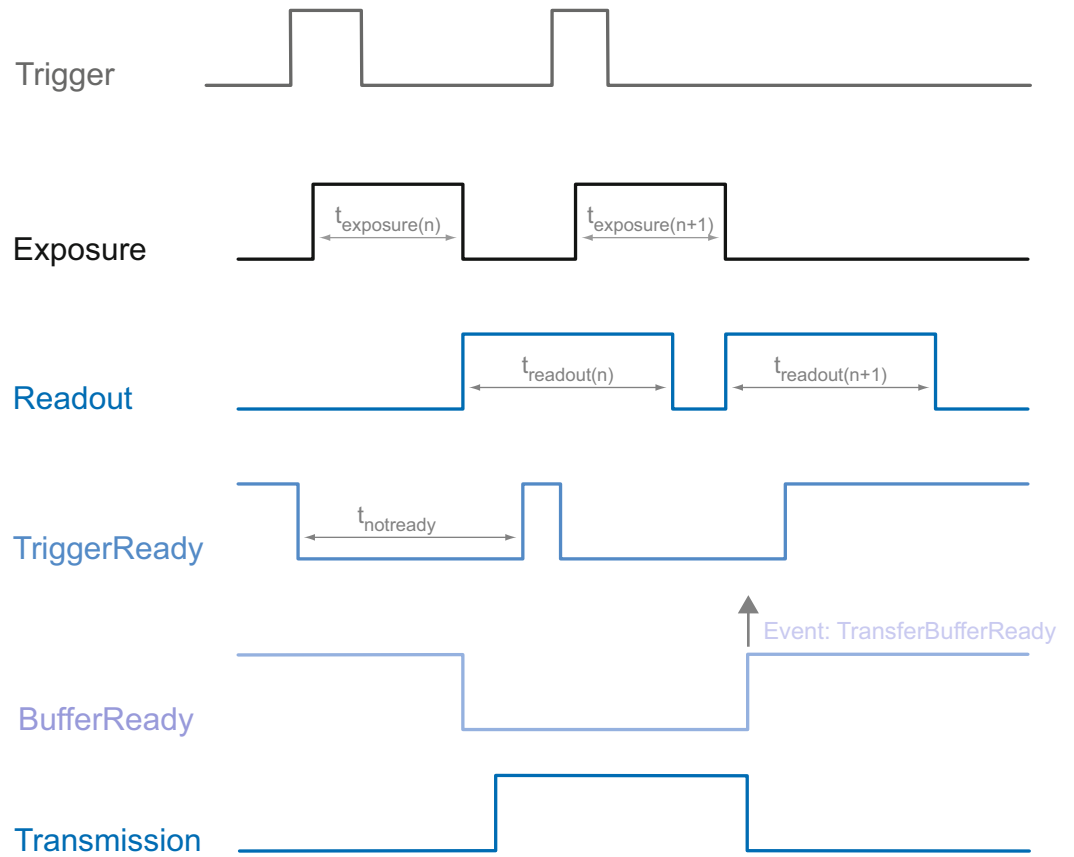

7.10.20.1 DeviceTemperatureStatusChanged

To prevent damage on the hardware due to high temperatures, the camera is equipped with an emergency shutdown. The *DeviceTemperatureStatusTransitionSelector* (Category: *Device Control*) feature allows you to select different thresholds for temperatures:

NormalToHigh: freely programmable value

HighToExceeded: fixed value (camera shutdown if exceeded)

ExceededToNormal: freely programmable value, temperature for error-free re-activation of the camera.

DeviceTemperatureUnderrun (several models): fixed value (camera shutdown if value falls below)

In the *DeviceTemperatureStatusTransition* feature, the temperatures for the programmable temperature transitions are set.

The Event *DeviceTemperatureStatusChanged* is always generated when *DeviceTemperatureStatus* changes.

If the temperature rises above the value set at *HighToExceeded*, the *DeviceTemperatureExceeded* feature is set to *True*, the image recording is stopped, and the LED is set to red.

If the temperature falls below the *DeviceTemperatureUnderrun* value, the *DeviceTemperatureUnderrun* function is set to *True*, image recording is stopped and the LED lights up red.

For further use, the camera must be disconnected from the power supply after cooling down or heating a device reset should be carried out.

The sufficient cooling / heating is recognizable when the event *DeviceTemperatureStatusChanged* (*Device Temperature* < *ExceededToNormal*) / (*Device Temperature* > *DeviceTemperatureUnderrun*) is output.

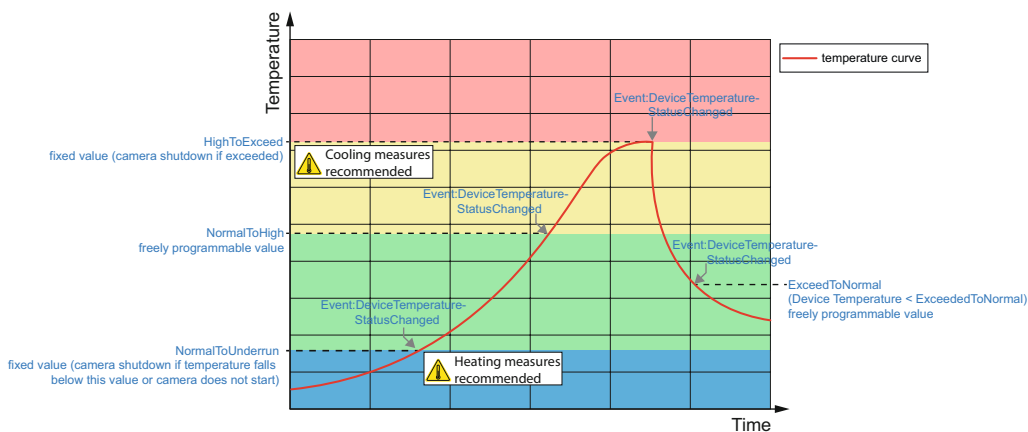

7.10.1 EventNotification

Activate or deactivate the notification to the host application of the occurrence of the selected Event.

Name	EventNotification	
Category	EventControl	
Interface	IEnumeration	
Access	Read / Write	
Unit	-	
Values	Off	The selected Event notification is disabled.
	On	The selected Event notification is enabled.

7.10.2 EventSelector

Selects which Event to signal to the host application.

Name	EventSelector
Category	EventControl
Interface	IEnumeration
Access	Read / Write
Unit	-
Values	see table below

V CXG / .XC / .PTP	V CXG.I / .I.XT / .PTP	V CXU / .XC
DeviceTemperatureStatus-Changed (≥ Rel. 2)	DeviceTemperatureStatus-Changed (≥ Rel. 2)	DeviceTemperatureStatus-Changed (≥ Rel. 2)
EventLost	EventLost	EventLost
ExposureEnd	ExposureEnd	ExposureEnd
ExposureStart	ExposureStart	ExposureStart
FrameEnd	FrameEnd	FrameEnd
FrameStart	FrameStart	FrameStart
FrameTransferSkipped	FrameTransferSkipped	FrameTransferSkipped
Error	Error	-
GigEVisionHeartbeatTime-Out	GigEVisionHeartbeatTime-Out	-
Line0..3 FallingEdge	Line0..7 FallingEdge	Line0..3 FallingEdge
Line0..3 RisingEdge	Line0..7 RisingEdge	Line0..3 RisingEdge
PrimaryApplicationSwitch	PrimaryApplicationSwitch	-
PtpServoStatusChanged*	PtpServoStatusChanged*	-
PtpStatusChanged*	PtpStatusChanged*	-
<div style="border: 1px solid black; padding: 5px;"> Notice There is a possibility that a large number of events <i>PtpStatusChanged</i> will be issued as long as <i>PtpServoStatus</i> ≠ <i>Locked</i>. </div>		-
TransferBufferFull	TransferBufferFull	TransferBufferFull
TransferBufferReady	TransferBufferReady	TransferBufferReady
TriggerOverlapped	TriggerOverlapped	TriggerOverlapped
TriggerReady	TriggerReady,	TriggerReady
TriggerSkipped	TriggerSkipped	TriggerSkipped

*) .PTP only

7.10.3 LostEventCounter

Counts lost events.

Name	LostEventCounter
Category	EventControl
Interface	Integer
Access	Read only
Unit	-
Values	0 ... 9223372036854775807 (Increment: 1)

7.11 Category: ImageFormatControl

This chapter describes how to influence and determine the image size and format.

Region of Interest (OffsetX / OffsetY / Width / Height) - General Information

You can use the "Region of Interest" (ROI) function to predefine a so-called region of interest or partial scan. This ROI is an area of pixels on the sensor. When an image is acquired, only the information regarding these pixels is transferred to the PC. Not all of the lines on the sensor are read out, which therefore decreases the readout time (t_{readout}). This increases the frame rate.

This function is used if only a particular region of the field of view is of interest. It also reduces the resolution.

The ROI is specified using four values:

- OffsetX - x-coordinate of the first relevant pixel
- OffsetY - y-coordinate of the first relevant pixel
- Width - horizontal size of the ROI
- Height - vertical size of the ROI

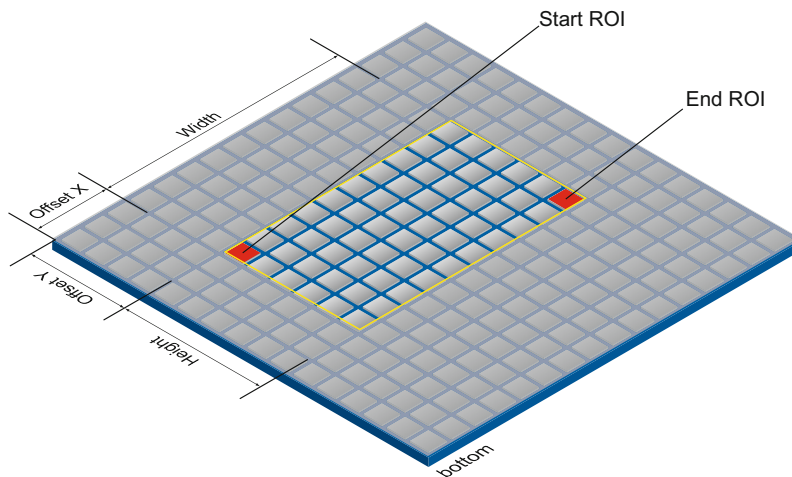

ROI Readout

In the illustration below, the readout time would decrease to 40% of a full frame readout.

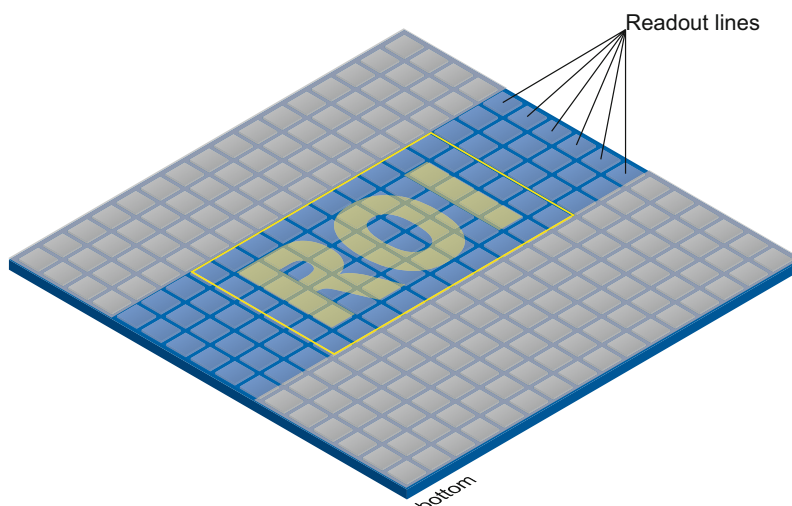

Binning (BinningHorizontal / BinningVertical) - General Information

On digital cameras, you can find several operations for progressing sensitivity. One of them is the so-called "Binning". Here, the charge carriers of neighboring pixels are aggregated. Thus, the progression is greatly increased by the amount of binned pixels. By using this operation, the progression in sensitivity is coupled to a reduction in resolution. Higher sensitivity enables shorter exposure times.

Baumer cameras support three types of Binning - vertical, horizontal and bidirectional.







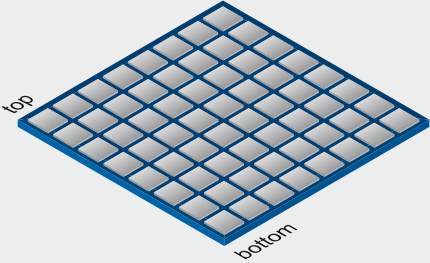

In unidirectional binning, vertically or horizontally neighboring pixels are aggregated and reported to the software as one single "superpixel".

In bidirectional binning, a square of neighboring pixels is aggregated.

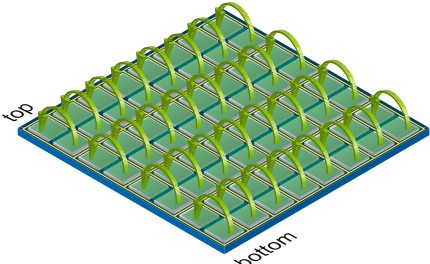
Notice

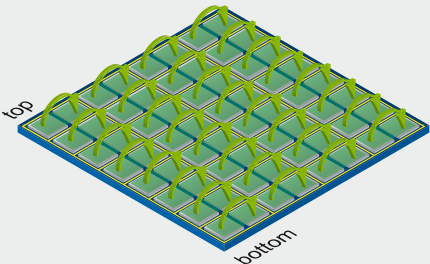
Occuring deviations in brightness after binning can be corrected with *Brightness Correction* function.

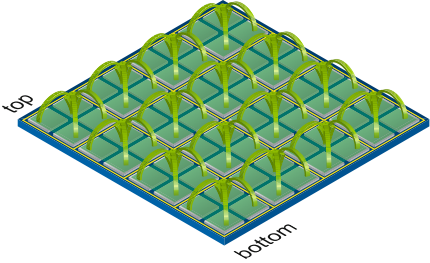
Monochrome Binning

Binning	Illustration	Output
without		
1x2		
2x1		
2x2		

Full frame image, no binning of pixels.

Vertical binning causes a vertically compressed image with doubled brightness.

Horizontal binning causes a horizontally compressed image with doubled brightness.

Bidirectional binning causes both a horizontally and vertically compressed image with quadruple brightness.

Color Binning

Color Binning is calculating on the camera (no higher frame rates) – The sensor does not support this binning operation.

Color calculated pixel formats

In pixel formats, which are not raw formats (e.g. RGB8), the three calculated color values (R, G, B) of a pixel will be added with those of the corresponding neighbor pixel during binning.

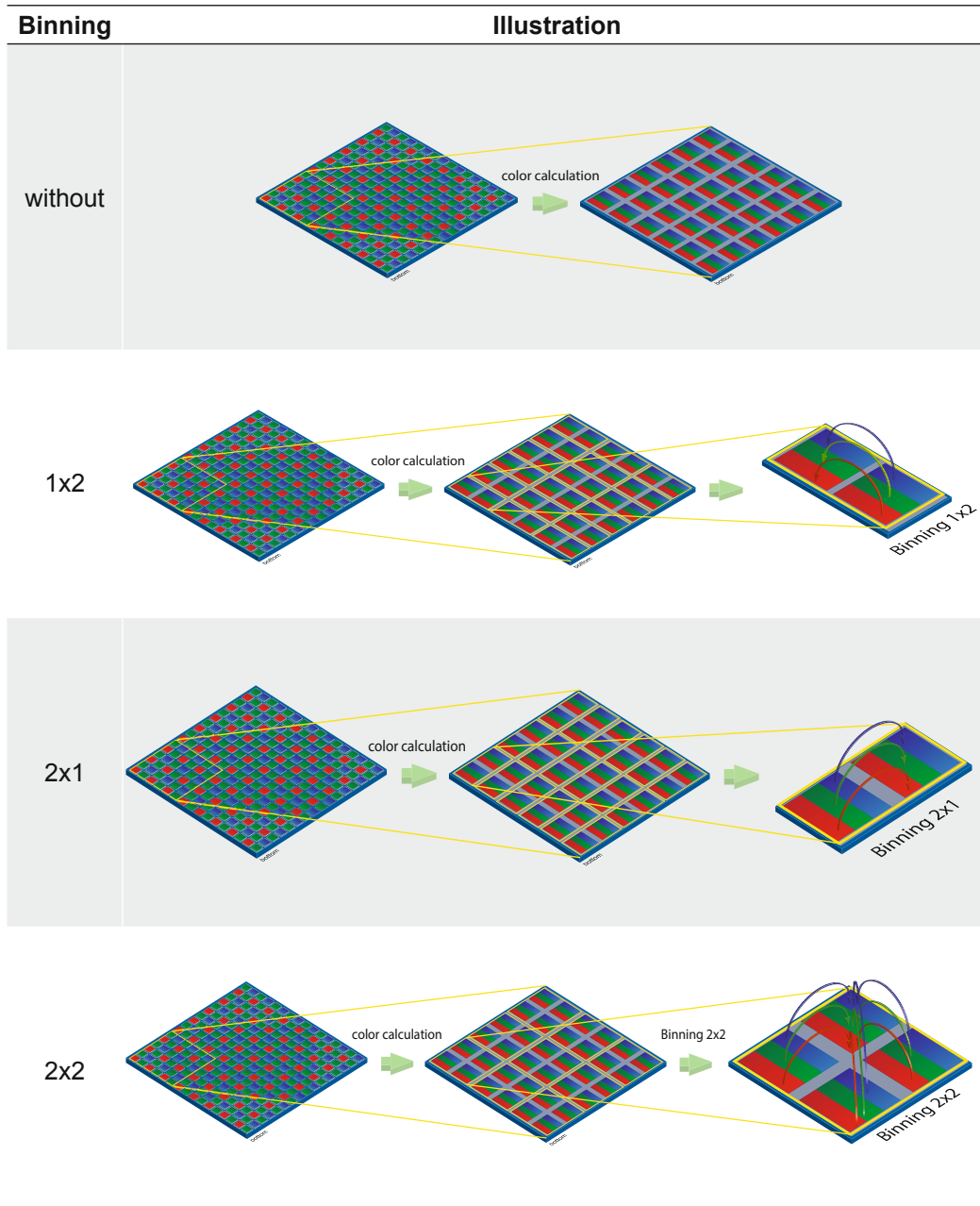

RAW pixel formats

In the raw pixel formats (e.g. BayerRG8) the color values of neighboring pixels with the same color are combined.

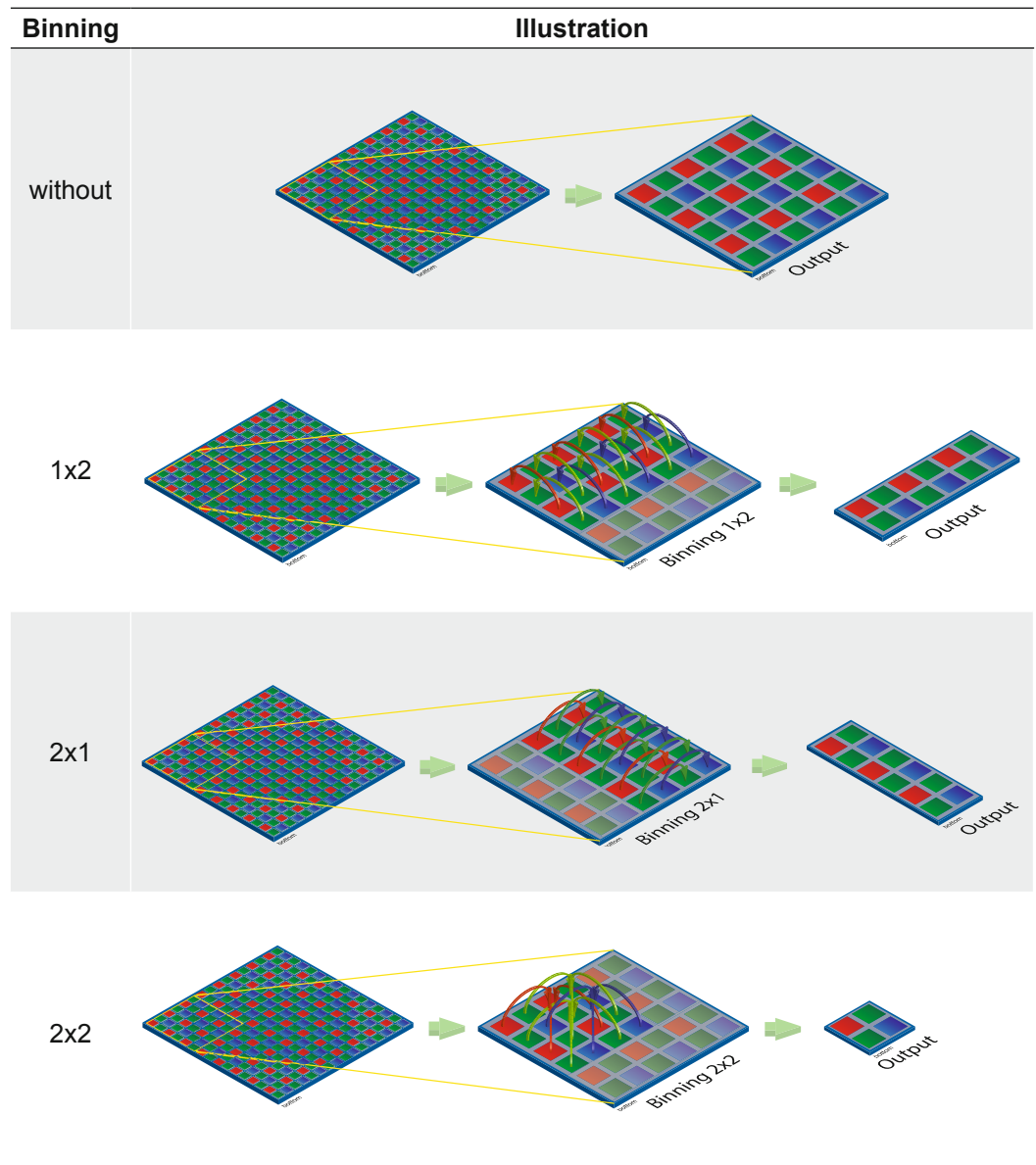

7.11.1 BinningHorizontal

Number of horizontal photo-sensitive cells to combine together. This increases the intensity (or signal to noise ratio) of the pixels and reduces the horizontal resolution (width) of the image.

Name	BinningHorizontal
Category	ImageFormatControl
Interface	Integer
Access	Read / Write
Unit	-
Values	see tables below (Increment: 1)

7.11.1.1 VCXG / .XC / .I / .I.XT / .PTP / .I.PTP

	BinningSelector [Region0]	BinningSelector [Sensor]
Monochrome		
VCXG-02M	1 ... 2	1 ... 1
VCXG-03SWIR.XC	1 ... 2	1 ... 1
VCXG-04M	1 ... 2	1 ... 1
VCXG-13M / .I/.I.XT	1 ... 2	1 ... 1
VCXG-13NIR	1 ... 2	1 ... 1
VCXG-14SWIR.XC	1 ... 2	1 ... 1
VCXG-15M / .I/.I.XT	1 ... 2	1 ... 2 [*]
VCXG-22M.R	1 ... 2	1 ... 1
VCXG-23M	1 ... 2	1 ... 1
VCXG-24M	1 ... 2	1 ... 1
VCXG-25M / .I/.I.XT	1 ... 2	1 ... 1
VCXG-32M / .I/.I.XT/.PTP/.I.PTP	1 ... 2	1 ... 1
VCXG-50MP	1 ... 2	1 ... 1
VCXG-51M / .XC / .I/.I.XT/.PTP/.I.PTP	1 ... 2	1 ... 1
VCXG-53M / .I/.I.XT	1 ... 2	1 ... 1
VCXG-53NIR	1 ... 2	1 ... 1
VCXG-65M.R	1 ... 2	1 ... 1
VCXG-82M / .I/.I.XT	1 ... 2	1 ... 2
VCXG-91M	1 ... 2	1 ... 1
VCXG-124M / .I/.I.XT/.PTP/.I.PTP	1 ... 2	1 ... 1
VCXG-125M.R	1 ... 2	1 ... 1
VCXG-127M / .I/.I.XT	1 ... 2	1 ... 2
VCXG-201M.R / .I/.I.XT	1 ... 2	1 ... 1
VCXG-204M	1 ... 2	1 ... 2
VCXG-241M / .I/.I.XT	1 ... 2	1 ... 2
Color		
VCXG-02C	1 ... 2	1 ... 1
VCXG-04C	1 ... 2	1 ... 1
VCXG-13C / .I/.I.XT	1 ... 2	1 ... 1
VCXG-15C / .I/.I.XT	1 ... 2	1 ... 1
VCXG-22C.R	1 ... 2	1 ... 1
VCXG-23C	1 ... 2	1 ... 1
VCXG-24C	1 ... 2	1 ... 1
VCXG-25C / .I/.I.XT	1 ... 2	1 ... 1
VCXG-32C / .I/.I.XT/.PTP/.I.PTP	1 ... 2	1 ... 1
VCXG-51C / .I/.I.XT/.PTP/.I.PTP	1 ... 2	1 ... 1
VCXG-53C / .I/.I.XT	1 ... 2	1 ... 1
VCXG-65C.R	1 ... 2	1 ... 1
VCXG-82C / .I/.I.XT	1 ... 2	1 ... 1
VCXG-91C	1 ... 2	1 ... 1
VCXG-124C / .I/.I.XT/.PTP/.I.PTP	1 ... 2	1 ... 1
VCXG-125C.R	1 ... 2	1 ... 1
VCXG-127C / .I/.I.XT	1 ... 2	1 ... 1
VCXG-91C	1 ... 2	1 ... 1
VCXG-201C.R / .I/.I.XT	1 ... 2	1 ... 1
VCXG-204C	1 ... 2	1 ... 1
VCXG-241C / .I/.I.XT	1 ... 2	1 ... 1

Notice
On the VCXG-15M binning is calculated in the sensor. In contrast to binning in the FPGA, the binning in the sensor increases the frame rate.

^{*}) *BinningVertical* is also switched to 2

7.11.1.2 VCXU / .XC

Notice

On the VCXU-15M, VCXU-90M, VCXU-123M, binning is calculated in the sensor. In contrast to binning in the FPGA, the binning in the sensor increases the frame rate.

Camera Type	BinningSelector [Region0]	BinningSelector [Sensor]
Monochrome		
VCXU-02M	1 ... 2	1 ... 1
VCXU-04M	1 ... 2	1 ... 1
VCXU-13M	1 ... 2	1 ... 1
VCXU-15M	1 ... 2	1 ... 2 [*]
VCXU-22M.R	1 ... 2	1 ... 1
VCXU-23M	1 ... 2	1 ... 1
VCXU-24M	1 ... 2	1 ... 1
VCXU-25M / .XC	1 ... 2	1 ... 1
VCXU-31M	1 ... 2	1 ... 1
VCXU-32M	1 ... 2	1 ... 1
VCXU-50M	1 ... 2	1 ... 1
VCXU-50MP	1 ... 2	1 ... 1
VCXU-51M	1 ... 2	1 ... 1
VCXU-53M	1 ... 2	1 ... 1
VCXU-65M.R	1 ... 2	1 ... 1
VCXU-90M	1 ... 2	1 ... 2 [*]
VCXU-91M	1 ... 2	1 ... 1
VCXU-123M	1 ... 2	1 ... 2 [*]
VCXU-124M	1 ... 2	1 ... 1
VCXU-125M.R	1 ... 2	1 ... 1
VCXU-201M.R	1 ... 2	1 ... 1
Color		
VCXU-02C	1 ... 2	1 ... 1
VCXU-04C	1 ... 2	1 ... 1
VCXU-13C	1 ... 2	1 ... 1
VCXU-15C	1 ... 2	1 ... 1
VCXU-22C.R	1 ... 2	1 ... 1
VCXU-23C	1 ... 2	1 ... 1
VCXU-24C	1 ... 2	1 ... 1
VCXU-25C	1 ... 2	1 ... 1
VCXU-31C	1 ... 2	1 ... 1
VCXU-32C	1 ... 2	1 ... 1
VCXU-50C	1 ... 2	1 ... 1
VCXU-51C	1 ... 2	1 ... 1
VCXU-53C	1 ... 2	1 ... 1
VCXU-65C.R	1 ... 2	1 ... 1
VCXU-90C	1 ... 2	1 ... 1
VCXU-91C	1 ... 2	1 ... 1
VCXU-123C	1 ... 2	1 ... 1
VCXU-124C	1 ... 2	1 ... 1
VCXU-125C.R	1 ... 2	1 ... 1
VCXU-201C.R	1 ... 2	1 ... 1

^{*}) *BinningVertical* is also switched to 2

7.11.2 BinningHorizontalMode

Sets the mode to use to combine horizontal photo-sensitive cells together when BinningHorizontal is used.

Name	BinningHorizontalMode	
Category	ImageFormatControl	
Interface	IEnumeration	
Access	Read / Write	
Unit	-	
Values	Average	The response from the combined cells will be averaged, resulting in increased signal/noise ratio.
	Sum	The response from the combined cells will be added, resulting in increased sensitivity.

7.11.3 BinningSelector

Selects which binning engine is controlled by the BinningHorizontal and BinningVertical features.

Name	BinningSelector	
Category	ImageFormatControl	
Interface	IEnumeration	
Access	Read / Write	
Unit	-	
Values	Region0	Selected feature will control the region 0 (FPGA) binning.
	Sensor	Selected features will control the sensor binning.

Known issues

Due to the sensor applied, some camera models have an offset of one pixel when binning performed in the sensor (`BinningSelector = [Sensor]`).

This behavior also occurs with a set Region of Interest (ROI).

Use binning via the FPGA (`BinningSelector = [Region0]`) if this behavior occurs in your application.

The following models are affected:

- VCXU-90M
- VCXU-123M

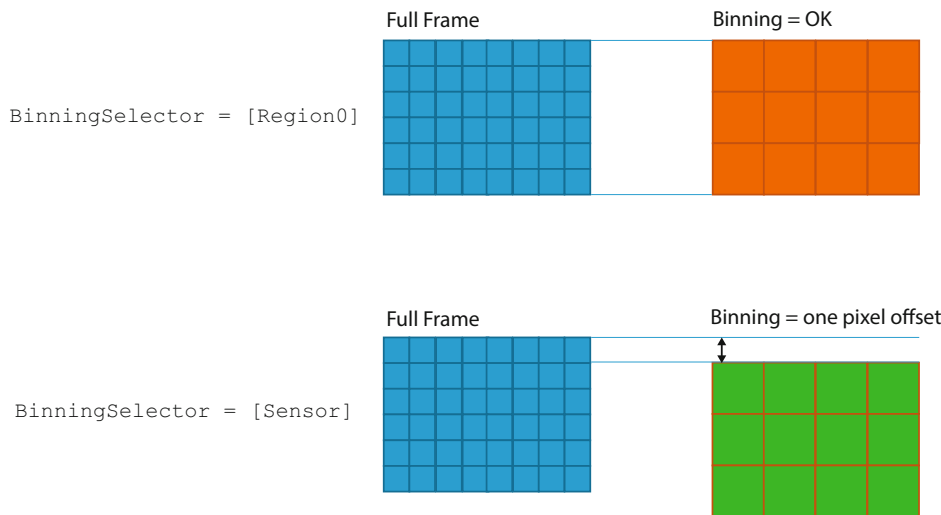

7.11.4 BinningVertical

Number of vertical photo-sensitive cells to combine together. This increases the intensity (or signal to noise ratio) of the pixels and reduces the vertical resolution (height) of the image.

Name	BinningVertical
Category	ImageFormatControl
Interface	Integer
Access	Read / Write
Unit	-
Values	see tables below (Increment: 1)

7.11.4.1 VCXG / .XC / .I / .I.XT / .PTP / .I.PTP

Notice

On the VCXG-15M binning is calculated in the sensor. In contrast to binning in the FPGA, the binning in the sensor increases the frame rate.

Camera Type	BinningSelector [Region0]	BinningSelector [Sensor]
Monochrome		
VCXG-02M	1 ... 2	1 ... 1
VCXG-03SWIR.XC	1 ... 2	1 ... 1
VCXG-04M	1 ... 2	1 ... 1
VCXG-13M / .I/.I.XT	1 ... 2	1 ... 1
VCXG-13NIR	1 ... 2	1 ... 1
VCXG-14SWIR.XC	1 ... 2	1 ... 1
VCXG-15M / .I/.I.XT	1 ... 2	1 ... 2*
VCXG-22M.R	1 ... 2	1 ... 1
VCXG-23M	1 ... 2	1 ... 1
VCXG-24M	1 ... 2	1 ... 1
VCXG-25M / .I/.I.XT	1 ... 2	1 ... 1
VCXG-32M / .I/.I.XT/.PTP/.I.PTP	1 ... 2	1 ... 1
VCXG-50MP	1 ... 2	1 ... 1
VCXG-51M / .XC / .I/.I.XT/.PTP/.I.PTP	1 ... 2	1 ... 1
VCXG-53M / .I/.I.XT	1 ... 2	1 ... 1
VCXG-53NIR	1 ... 2	1 ... 1
VCXG-65M.R	1 ... 2	1 ... 1
VCXG-82M / .I/.I.XT	1 ... 2	1 ... 2
VCXG-91M	1 ... 2	1 ... 1
VCXG-124M / .I/.I.XT/.PTP/.I.PTP	1 ... 2	1 ... 1
VCXG-125M.R	1 ... 2	1 ... 1
VCXG-127M / .I/.I.XT	1 ... 2	1 ... 2
VCXG-201M.R / .I/.I.XT	1 ... 2	1 ... 1
VCXG-204M	1 ... 2	1 ... 2
VCXG-241M / .I/.I.XT	1 ... 2	1 ... 2

*) *BinningHorizontal* is also switched to 2

Camera Type	BinningSelector [Region0]	BinningSelector [Sensor]
Color		
VCXG-02C	1 ... 2	1 ... 1
VCXG-04C	1 ... 2	1 ... 1
VCXG-13C / .I/.I.XT	1 ... 2	1 ... 1
VCXG-15C / .I/.I.XT	1 ... 2	1 ... 1
VCXG-22C.R	1 ... 2	1 ... 1
VCXG-23C	1 ... 2	1 ... 1
VCXG-24C	1 ... 2	1 ... 1
VCXG-25C / .I/.I.XT	1 ... 2	1 ... 1
VCXG-32C / .I/.I.XT/.PTP/.I.PTP	1 ... 2	1 ... 1
VCXG-51C / .I/.I.XT/.PTP/.I.PTP	1 ... 2	1 ... 1
VCXG-53C / .I/.I.XT	1 ... 2	1 ... 1
VCXG-65C.R	1 ... 2	1 ... 1
VCXG-82C / .I/.I.XT	1 ... 2	1 ... 1
VCXG-91C	1 ... 2	1 ... 1
VCXG-124C / .I/.I.XT/.PTP/.I.PTP	1 ... 2	1 ... 1
VCXG-125C.R	1 ... 2	1 ... 1
VCXG-127C / .I/.I.XT	1 ... 2	1 ... 1
VCXG-201C.R / .I/.I.XT	1 ... 2	1 ... 1
VCXG-204C	1 ... 2	1 ... 1
VCXG-241C / .I/.I.XT	1 ... 2	1 ... 1

7.11.4.2 VCXU / .XC

Notice

On the VCXU-15M, VCXU-90M, VCXU-123M, binning is calculated in the sensor. In contrast to binning in the FPGA, the binning in the sensor increases the frame rate.

Camera Type	BinningSelector [Region0]	BinningSelector [Sensor]
Monochrome		
VCXU-02M	1 ... 2	1 ... 1
VCXU-04M	1 ... 2	1 ... 1
VCXU-13M	1 ... 2	1 ... 1
VCXU-15M	1 ... 2	1 ... 2*
VCXU-22M.R	1 ... 2	1 ... 1
VCXU-23M	1 ... 2	1 ... 1
VCXU-24M	1 ... 2	1 ... 1
VCXU-25M / .XC	1 ... 2	1 ... 1
VCXU-31M	1 ... 2	1 ... 1
VCXU-32M	1 ... 2	1 ... 1
VCXU-50M	1 ... 2	1 ... 1
VCXU-50MP	1 ... 2	1 ... 1
VCXU-51M	1 ... 2	1 ... 1
VCXU-53M	1 ... 2	1 ... 1
VCXU-65M.R	1 ... 2	1 ... 1
VCXU-90M	1 ... 2	1 ... 2*
VCXU-91M	1 ... 2	1 ... 1
VCXU-123M	1 ... 2	1 ... 2*
VCXU-124M	1 ... 2	1 ... 1
VCXU-125M.R	1 ... 2	1 ... 1
VCXU-201M.R	1 ... 2	1 ... 1

Camera Type	BinningSelector [Region0]	BinningSelector [Sensor]
Color		
VCXU-02C	1 ... 2	1 ... 1
VCXU-04C	1 ... 2	1 ... 1
VCXU-13C	1 ... 2	1 ... 1
VCXU-15C	1 ... 2	1 ... 1
VCXU-22C.R	1 ... 2	1 ... 1
VCXU-23C	1 ... 2	1 ... 1
VCXU-24C	1 ... 2	1 ... 1
VCXU-25C	1 ... 2	1 ... 1
VCXU-31C	1 ... 2	1 ... 1
VCXU-32C	1 ... 2	1 ... 1
VCXU-50C	1 ... 2	1 ... 1
VCXU-51C	1 ... 2	1 ... 1
VCXU-53C	1 ... 2	1 ... 1
VCXU-65C.R	1 ... 2	1 ... 1
VCXU-90C	1 ... 2	1 ... 1
VCXU-91C	1 ... 2	1 ... 1
VCXU-123C	1 ... 2	1 ... 1
VCXU-124C	1 ... 2	1 ... 1
VCXU-125C.R	1 ... 2	1 ... 1
VCXU-201C.R	1 ... 2	1 ... 1

^{*)} *BinningHorizontal* is also switched to 2

7.11.5 BinningVerticalMode

The response from the combined cells will be averaged, resulting in increased signal/noise ratio.

Name	BinningVerticalMode	
Category	ImageFormatControl	
Interface	IEnumeration	
Access	Read / Write	
Unit	-	
Values	Average	The response from the combined cells will be averaged, resulting in increased signal/noise ratio.
	Sum	The response from the combined cells will be added, resulting in increased sensitivity.

7.11.6 Category: ImageFormatControl → CalibrationControl (MP cameras only)

That is the category that contains features to control the calibration of the four polarized light channels.

The Baumer polarization cameras are based on the Sony IMC250MZR Sensor. This sensor is coated with a metal-mesh which filters the polarization information on 4 adjacent pixels. The polarization angle is filtered with an alignment of 0°, 45°, 90° and 135°.

With this information the following data can be calculated:

Baumer GAPI v2.9	Baumer GAPI v2.10	Baumer GAPI v2.11	Baumer GAPI v2.12
ADOLP	ADOLP	ADOLP	ADOLP
AOP	AOP	AOP	AOP
DOLP	DOLP	DOLP	DOLP
Intensity	Intensity	Intensity	Intensity
	POL0	POL0	POL0
	POL45	POL45	POL45
	POL90	POL90	POL90
	POL135	POL135	POL135
	POLMIN	POLMIN	POLMIN
	POLMAX	POLMAX	POLMAX
			POL
			UNPOL

The Camera Explorer can also be used to view and save polarization data in these formats. The configuration is done in the *Polarization* widget.

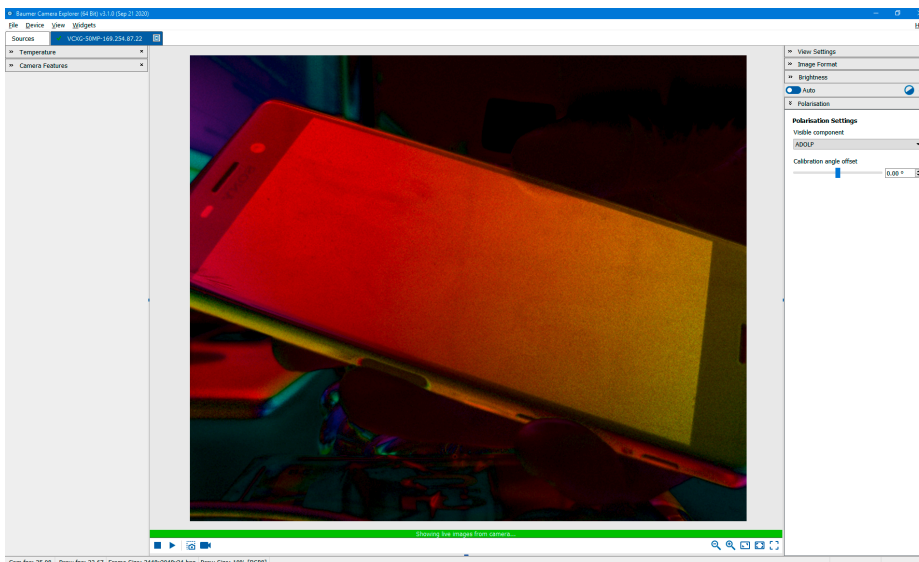

7.11.6.1 CalibrationAngleOfPolarizationOffset

Adds a calibration offset to compensate for an individual "roll" angle of the camera, introduced by mounting tolerances. The offset is added to all type of output data that incorporates an angle, like false color representation and angle of polarization data. The offset is without effect to raw data and to degree of linear polarization data.

Name	CalibrationAngleOfPolarizationOffset
Category	ImageFormatControl → CalibrationControl
Interface	IFloat
Access	Read / Write
Unit	°
Values	-180 ... 179.9 (Increment: 0.1)

7.11.6.2 CalibrationEnable

Activates the calibration of the four polarized light channels by applying matrix calculations and an angle offset.

Name	CalibrationEnable
Category	ImageFormatControl → CalibrationControl
Interface	IBoolean
Access	Read / Write
Unit	-
Values	true = 1 (On) false = 0 (Off)

7.11.6.3 CalibrationMatrixValue

Represents the value of the selected gain factor inside the calibration matrix.

Name	CalibrationMatrixValue
Category	ImageFormatControl → CalibrationControl
Interface	IFloat
Access	Read / Write
Unit	-
Values	-8 ... 7.99999999627470970154 (Increment: 0.00001)

7.11.6.4 CalibrationMatrixValueSelector

Selects the gain factor of the calibration matrix.

Name	CalibrationMatrixValueSelector
Category	ImageFormatControl → CalibrationControl
Interface	IEnumeration
Access	Read / Write
Unit	-
Values	Gain Gain00 ... Gain23

7.11.7 ComponentEnable (MP cameras only)

Controls, if streaming of the component selected by feature ComponentSelector is active.

Name	ComponentEnable
Category	ImageFormatControl
Interface	IBoolean
Access	Read only
Unit	-
Values	true = 1 (On) false = 0 (Off)

7.11.8 ComponentSelector (MP cameras only)

Selects, which data acquisition component to use.

Name	ComponentSelector
Category	ImageFormatControl
Interface	IEnumeration
Access	Read / Write
Unit	-
Values	PolarizedRaw Acquisition of polarized light intensity. The polarizing filters are arranged in a 2-by-2 pattern: 135° and 0° on even lines, 90° and 45° on odd lines. The raw data is unprocessed.

7.11.9 Height

Height of the image provided by the device (in pixels). The selected value changes with the change of *Binning*.

Notice

The sum of *OffsetY* and *Height* must be smaller or equal than *HeightMax*.

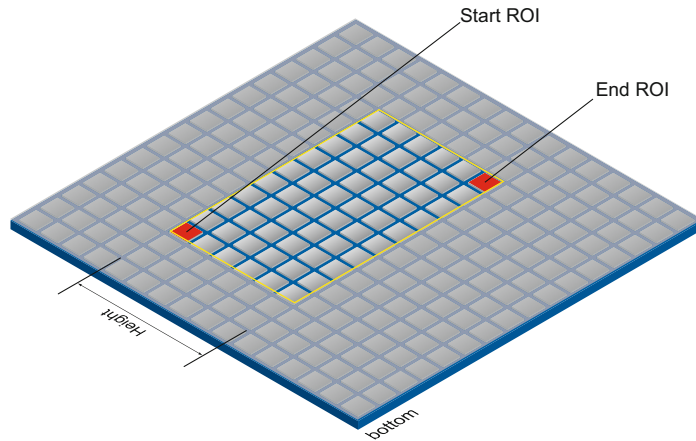

Name	Height
Category	ImageFormatControl
Interface	Integer
Access	Read / Write
Unit	-
Values	see tables below

7.11.9.1 VCXG /.XC / .I / .I.XT / .PTP / .I.PTP

Camera Type	Values
Monochrome	
VCXG-02M	1* 2 ... 480 (Increment: 1* 2)
VCXG-03SWIR.XC	2 ... 520 (Increment: 2)
VCXG-04M	1* 2 ... 540 (Increment: 1* 2)
VCXG-13M / .I/.I.XT	1* 2 ... 1024 (Increment: 1* 2)
VCXG-13NIR	1 ... 1024 (Increment: 1)
VCXG-14SWIR.XC	2 ... 1032 (Increment: 2)
VCXG-15M / .I/.I.XT	1* 4 ... 1080 (Increment: 1* 4)
VCXG-22M.R	2 ... 1080 (Increment: 2)
VCXG-23M	1* 2 ... 1200 (Increment: 1* 2)
VCXG-24M	1* 2 ... 1200 (Increment: 1* 2)
VCXG-25M / .I/.I.XT	1* 2 ... 1200 (Increment: 1* 2)
VCXG-32M / .I/.I.XT/.PTP/.I.PTP	1* 2 ... 1536 (Increment: 1* 2)
VCXG-51M / XC .I/.I.XT/.PTP/.I.PTP	1* 2 ... 2048 (Increment: 1* 2)
VCXG-50MP	1* 2 ... 2048 (Increment: 1* 2)
VCXG-53M / .I/.I.XT	1* 2 ... 2048 (Increment: 1* 2)
VCXG-53NIR	1 ... 2048 (Increment: 1* 2)
VCXG-65M.R	2 ... 2048 (Increment: 2)
VCXG-82M / .I/.I.XT	1 ... 2832 (Increment: 1)
VCXG-91M	1* 2 ... 2160 (Increment: 1* 2)
VCXG-124M / .I/.I.XT/.PTP/.I.PTP	1* 2 ... 3000 (Increment: 1* 2)
VCXG-125M.R	2 ... 3000 (Increment: 2)
VCXG-127M / .I/.I.XT	1 ... 2992 (Increment: 1)
VCXG-201M.R / .I/.I.XT	2 ... 3648 (Increment: 2)
VCXG-204M	1 ... 4496 (Increment: 1)
VCXG-241M / .I/.I.XT	1 ... 4600 4592 ^{*)} (Increment: 1)
Color	
VCXG-02C	2* 4 ... 480 (Increment: 2* 4)
VCXG-04C	2* 4 ... 540 (Increment: 2* 4)
VCXG-13C / .I/.I.XT	2* 4 ... 1024 (Increment: 2* 4)
VCXG-15C / .I/.I.XT	2* 4 ... 1080 (Increment: 2* 4)
VCXG-22C.R	4 ... 1080 (Increment: 4)
VCXG-23C	2* 4 ... 1200 (Increment: 2* 4)
VCXG-24C	2* 4 ... 1200 (Increment: 2* 4)
VCXG-25C / .I/.I.XT	2* 4 ... 1200 (Increment: 2* 4)
VCXG-32C / .I/.I.XT/.PTP/.I.PTP	2* 4 ... 1536 (Increment: 2* 4)
VCXG-51C / .I/.I.XT/.PTP/.I.PTP	2* 4 ... 2048 (Increment: 2* 4)
VCXG-53C / .I/.I.XT	2* 4 ... 2048 (Increment: 2* 4)
VCXG-65C.R	4 ... 2048 (Increment: 4)
VCXG-82C / .I/.I.XT	2 ... 4832 (Increment: 2)
VCXG-91C	2* 4 ... 2160 (Increment: 2* 4)
VCXG-124C / .I/.I.XT/.PTP/.I.PTP	2* 4 ... 3000 (Increment: 2* 4)
VCXG-125C.R	4 ... 3000 (Increment: 4)
VCXG-127C / .I/.I.XT	2 ... 2992 (Increment: 2)
VCXG-201C.R / .I/.I.XT	4 ... 3648 (Increment: 4)
VCXG-204C	2 ... 4496 (Increment: 2)
VCXG-241C / .I/.I.XT	2 ... 4592 (Increment: 2)

Notice

VCXU-201M.R (Rel. 4)
VCXG-201C.R (Rel. 4)

In pixel formats:

- Mono8
- Mono10
- Bayer RG8
- Bayer RG10

and Region of Interest (ROI) (*Height* 1649 ... 3648) vertical partial scan will be done in the sensor.

This leads to an increase of the frame rate.

The other area (*Height* 1 ... 1648) is done in the FPGA and the frame rate does not increase.

In the other pixel formats, partial scan is done only in the FPGA and the frame rate does not increase either.

^{*)} ≥ Release 3

^{**)} ≥ Release 4

7.11.9.2 VCXU / .XC

Camera Type	Values
Monochrome	
VCXU-02M	1* 2 ... 480 (Increment: 1* 2)
VCXU-04M	1* 2 ... 540 (Increment: 1* 2)
VCXU-13M	1* 2 ... 1024 (Increment: 1* 2)
VCXU-15M	1* 4 ... 1080 (Increment: 1* 4)
VCXU-22M.R	2* 2 ... 1080 (Increment: 2* 2)
VCXU-23M	1* 2 ... 1200 (Increment: 1* 2)
VCXU-24M	1* 2 ... 1200 (Increment: 1* 2)
VCXU-25M / .XC	1* 2 ... 1200 (Increment: 1* 2)
VCXU-31M	1* 2 ... 1536 (Increment: 1* 2)
VCXU-32M	1* 2 ... 1536 (Increment: 1* 2)
VCXU-50M	1* 2 ... 2048 (Increment: 1* 2)
VCXU-50MP	1* 2 ... 2048 (Increment: 1* 2)
VCXU-51M	1* 2 ... 2048 (Increment: 1* 2)
VCXU-53M	1* 2 ... 2048 (Increment: 1* 2)
VCXU-65M.R	2* 2 ... 2048 (Increment: 2* 2)
VCXU-90M	1* 4 ... 2160 (Increment: 1* 4)
VCXU-91M	1* 2 ... 2160 (Increment: 1* 2)
VCXU-123M	1* 4 ... 3000 (Increment: 1* 4)
VCXU-124M	1* 2 ... 3000 (Increment: 1* 2)
VCXU-125M.R	2* 2 ... 3000 (Increment: 2* 2)
VCXU-201M.R	2* 2 ... 3648 (Increment: 2* 2)
Color	
VCXU-02C	2* 4 ... 480 (Increment: 2* 4)
VCXU-04C	2* 4 ... 540 (Increment: 2* 4)
VCXU-13C	2* 4 ... 1024 (Increment: 2* 4)
VCXU-15C	2* 4 ... 1080 (Increment: 2* 4)
VCXU-22C.R	4* 4 ... 1080 (Increment: 4* 4)
VCXU-23C	2* 4 ... 1200 (Increment: 2* 4)
VCXU-24C	2* 4 ... 1200 (Increment: 2* 4)
VCXU-25C	2* 4 ... 1200 (Increment: 2* 4)
VCXU-31C	2* 4 ... 1536 (Increment: 2* 4)
VCXU-32C	2* 4 ... 1536 (Increment: 2* 4)
VCXU-50C	2* 4 ... 2048 (Increment: 2* 4)
VCXU-51C	2* 4 ... 2048 (Increment: 2* 4)
VCXU-53C	2* 4 ... 2048 (Increment: 2* 4)
VCXU-65C.R	4* 4 ... 2048 (Increment: 4* 4)
VCXU-90C	2* 4 ... 2160 (Increment: 2* 4)
VCXU-91C	2* 4 ... 2160 (Increment: 2* 4)
VCXU-123C	2* 4 ... 3000 (Increment: 2* 4)
VCXU-124C	2* 4 ... 3000 (Increment: 2* 4)
VCXU-125C.R	4* 4 ... 3000 (Increment: 4* 4)
VCXU-201C.R	4* 4 ... 3648 (Increment: 4* 4)

*) ≥ Release 3

7.11.10 HeightMax

Maximum height of the image (in pixels). This dimension is calculated after vertical binning, decimation or any other function changing the vertical dimension of the image.

Name	HeightMax
Category	ImageFormatControl
Interface	Integer
Access	Read only
Unit	-
Values	Resolution of the sensor in Y-direction. (see tables below)

7.11.10.1 VCXG /.XC / .I / .I.XT / .PTP / .I.PTP

Camera Type	Values
Monochrome	
VCXG-02M	480
VCXG-03SWIR.XC	520
VCXG-04M	540
VCXG-13M / .I/.I.XT	1024
VCXG-14SWIR.XC	1032
VCXG-13NIR	1024
VCXG-15M / .I/.I.XT	1080
VCXG-22M.R	1080
VCXG-23M	1200
VCXG-24M	1200
VCXG-25M / .I/.I.XT	1200
VCXG-32M / .I/.I.XT/.PTP/.I.PTP	1536
VCXG-50MP	2048
VCXG-51M /.XC / .I / .I.XT / .PTP / .I.PTP	2048
VCXG-53M / .I/.I.XT	2048
VCXG-53NIR	2048
VCXG-65M.R	2048
VCXG-82M / .I/.I.XT	2832
VCXG-91M	2160
VCXG-124M / .I/.I.XT/.PTP/.I.PTP	3000
VCXG-125M.R	3000
VCXG-127M / .I/.I.XT	2992
VCXG-201M.R/.I/.I.XT	3648
VCXG-204M	4496
VCXG-241M / .I/.I.XT	4600 4592 ^{*)}

^{*)} ≥ Release 4

Camera Type	Values
Color	
VCXG-02C	480
VCXG-04C	540
VCXG-13C / .I/.I.XT	1024
VCXG-15C / .I/.I.XT	1080
VCXG-22C.R	1080
VCXG-23C	1200
VCXG-24C	1200
VCXG-25C / .I/.I.XT	1200
VCXG-32C / .I/.I.XT/.PTP/.I.PTP	1536
VCXG-51C / .I/.I.XT/.PTP/.I.PTP	2048
VCXG-53C / .I/.I.XT	2048
VCXG-65C.R	2048
VCXG-82C / .I/.I.XT	2832
VCXG-91C	2160
VCXG-124C / .I/.I.XT/.PTP/.I.PTP	3000
VCXG-125C.R	3000
VCXG-127C / .I/.I.XT	2992
VCXG-201C.R.I/.I.XT	3648
VCXG-204C	4496
VCXG-241C / .I/.I.XT	4592

7.11.10.2 VCXU / .XC

Camera Type	Values
Monochrome	
VCXU-02M	480
VCXU-04M	540
VCXU-13M	1024
VCXU-15M	1080
VCXU-22M.R	1080
VCXU-23M	1200
VCXU-24M	1200
VCXU-25M / .XC	1200
VCXU-31M	1536
VCXU-32M	1536
VCXU-50M	2048
VCXU-50MP	2048
VCXU-51M	2048
VCXU-53M	2048
VCXU-65M.R	2048
VCXU-90M	2160
VCXU-91M	2160
VCXU-123M	3000
VCXU-124M	3000
VCXU-125M.R	3000
VCXU-201M.R	3648

Camera Type	Values
Color	
VCXU-02C	480
VCXU-04C	540
VCXU-13C	1024
VCXU-15C	1080
VCXU-22C.R	1080
VCXU-23C	1200
VCXU-24C	1200
VCXU-25C	1200
VCXU-31C	1536
VCXU-32C	1536
VCXU-50C	2048
VCXU-51C	2048
VCXU-53C	2048
VCXU-65C.R	2048
VCXU-90C	2160
VCXU-91C	2160
VCXU-123C	3000
VCXU-124C	3000
VCXU-125C.R	3000
VCXU-201C.R	3648
VCXU-201M.R	3648

7.11.11 OffsetX

Horizontal offset from the origin to the region of interest (in pixels).

Notice

The sum of *OffsetX* and *WidthMax* must be smaller or equal than *WidthMax*.

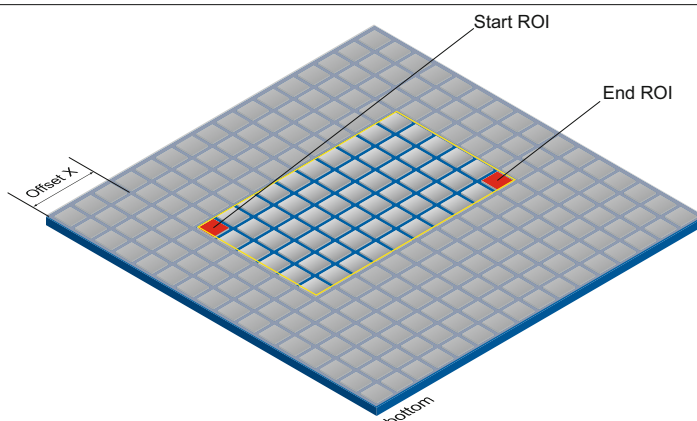

Name	OffsetX
Category	ImageFormatControl
Interface	Integer
Access	Read / Write
Unit	-
Values	0 - depends on <i>Width</i>

7.11.12 OffsetY

Vertical offset from the origin to the region of interest (in pixels).

Notice

The sum of *OffsetY* and *Height* must be smaller or equal than *HeightMax*.

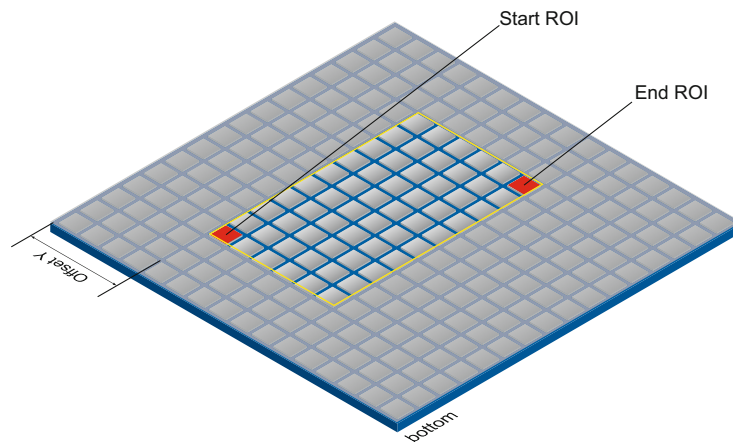

Name	OffsetY
Category	ImageFormatControl
Interface	Integer
Access	Read / Write
Unit	-
Values	0 - depends on <i>Height</i>

7.11.13 PixelFormat

Format of the pixels provided by the device. It represents all the information provided by PixelCoding, PixelSize, PixelColorFilter combined in a single feature.

General Information

RAW: Raw data format. Here the data are stored without processing.

Bayer: Raw data format of color sensors.

Color filters are placed on these sensors in a checkerboard pattern, generally in a 50% green, 25% red and 25% blue array.

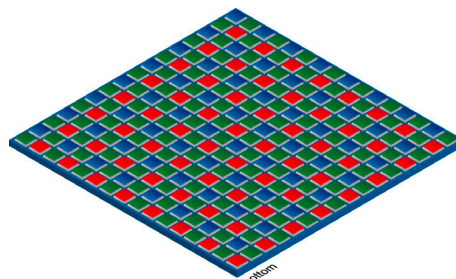

Mono: Monochrome. The color range of mono images consists of shades of a single color. In general, shades of gray or black-and-white are synonyms for monochrome.

RGB: Color model, in which all detectable colors are defined by three coordinates, Red, Green and Blue.

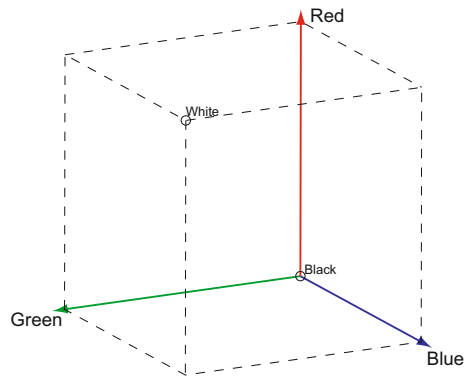

The three coordinates are displayed within the buffer in the order R, G, B.

BGR: At BGR the interface of the camera mirrors the order of transmission of the color channels from RGB to BGR.

This can save processing power on the computer, because these data can be processed by the graphic card without conversion.

Pixel depth: In general, pixel depth defines the number of possible different values for each color channel. Mostly this will be 8 bit, which means 2^8 different "colors".

For RGB or BGR these 8 bits per channel equal 24 bits overall.

Two bytes are needed for transmitting more than 8 bits per pixel - even if the second byte is not completely filled with data. In order to save bandwidth, the packed formats were introduced to Baumer CX cameras. In this formats, the unused bits of one pixel are filled with data from the next pixel.

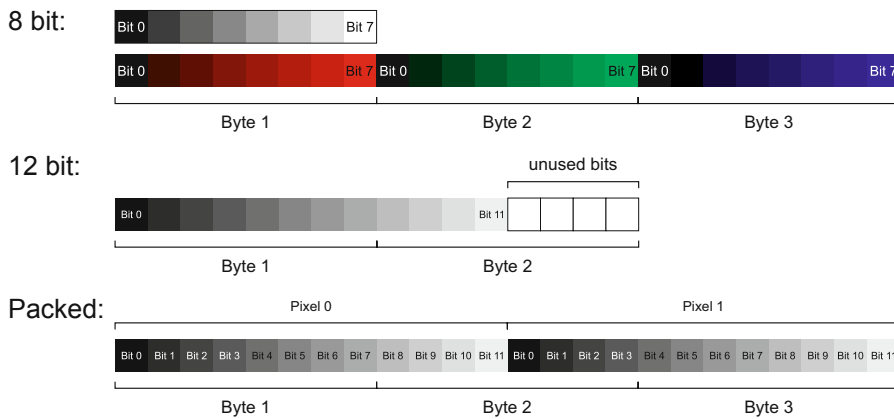

Notice

The camera must be stopped before *PixelFormat* can be set.

Name	PixelFormat
Category	ImageFormatControl
Interface	IEnumeration
Access	Read / Write
Unit	-
Values	see tables below

7.11.13.1 VCXG / .XC/ .I/ .I.XT / .PTP / .I.PTP

Notice

VCXU-201M.R (Rel. 4)
VCXG-201C.R (Rel. 4)

In pixel formats:

- Mono8
- Mono10
- Bayer RG8
- Bayer RG10

and Region of Interest (ROI) (*Height* 1649 ... 3648) vertical partial scan will be done in the sensor.

This leads to an increase of the frame rate.

The other area (*Height* 1 ... 1648) is done in the FPGA and the frame rate does not increase.

In the other pixel formats, partial scan is done only in the FPGA and the frame rate does not increase either.

Camera Type	Mono8	Mono10	Mono12	Mono12p	Bayer RG8	Bayer RG10	Bayer RG12	Bayer G12p	RGB8	BGR8
Monochrome										
VCXG-02M	■	■	□	□	□	□	□	□	□	□
VCXG-03SWIR.XC	■	■	■	■	□	□	□	□	□	□
VCXG-04M	■	■	■	■	□	□	□	□	□	□
VCXG-13M/.I/.I.XT	■	■	□	□	□	□	□	□	□	□
VCXG-13NIR	■	□	□	□	□	□	□	□	□	□
VCXG-14SWIR.XC	■	■	■	■	□	□	□	□	□	□
VCXG-15M/.I/.I.XT	■	■	■	■	□	□	□	□	□	□
VCXG-22M.R	■	■	■	■	□	□	□	□	□	□
VCXG-23M	■	■	■	■	□	□	□	□	□	□
VCXG-24M	■	■	■	■	□	□	□	□	□	□
VCXG-25M/.I/.I.XT	■	■	□	□	□	□	□	□	□	□
VCXG-32M/.I/.I.XT/.PTP/.I.PTP	■	■	■	■	□	□	□	□	□	□
VCXG-50MP	■	■	■	■	□	□	□	□	□	□
VCXG-51M/.XC/.I/.I.XT.PTP/.I.PTP	■	■	■	■	□	□	□	□	□	□
VCXG-53M/.I/.I.XT	■	■	□	□	□	□	□	□	□	□
VCXG-53NIR	■	□	□	□	□	□	□	□	□	□
VCXG-65M.R	■	■	■	■	□	□	□	□	□	□
VCXG-82M/.I/.I.XT	■	■	□	□	□	□	□	□	□	□
VCXG-91M	■	■	■	■	□	□	□	□	□	□
VCXG-124M/.I/.I.XT.PTP/.I.PTP	■	■	■	■	□	□	□	□	□	□
VCXG-125M.R	■	■	■	■	□	□	□	□	□	□
VCXG-127M/.I/.I.XT	■	■	■	■	□	□	□	□	□	□
VCXG-201M.R/.I/.I.XT	■	■	■	■	□	□	□	□	□	□
VCXG-204M	■	■	■	■	□	□	□	□	□	□
VCXG-241M/.I/.I.XT	■	■	■	■	□	□	□	□	□	□

Camera Type	Mono8	Mono10	Mono12	Mono12p	Bayer RG8	Bayer RG10	Bayer RG12	Bayer RG12p	RGB8	BGR8
Color										
VCXG-02C	■	■	□	□	■	■	□	□	■	■
VCXG-04C	■	■	■	■	■	■	■	■	■	■
VCXG-13C / .I/.I.XT	■	■	□	□	■	■	□	□	■	■
VCXG-15C / .I/.I.XT	■	■	■	■	■	■	■	■	■	■
VCXG-22C.R	■	■	■	■	■	■	■	■	■	■
VCXG-23C	■	■	■	■	■	■	■	■	■	■
VCXG-24C	■	■	■	■	■	■	■	■	■	■
VCXG-25C / .I/.I.XT	■	■	□	□	■	■	□	□	■	■
VCXG-32C / .I/.I.XT/.PTP/.I.PTP	■	■	■	■	■	■	■	■	■	■
VCXG-51C / .I/.I.XT/.PTP/.I.PTP	■	■	■	■	■	■	■	■	■	■
VCXG-53C / .I/.I.XT	■	■	□	□	■	■	□	□	■	■
VCXG-65C.R	■	■	■	■	■	■	■	■	■	■

VCXG-82C / .I/.I.XT	■	■	■	■	■	■	■	■	■	■	■
VCXG-91C	■	■	■	■	■	■	■	■	■	■	■
VCXG-124C/.I/.I.XT/.PTP/.I.PTP	■	■	■	■	■	■	■	■	■	■	■
VCXG-125C.R	■	■	■	■	■	■	■	■	■	■	■
VCXG-127C/.I/.I.XT	■	■	■	■	■	■	■	■	■	■	■
VCXG-201C.R/.I/.I.XT	■	■	■	■	■	■	■	■	■	■	■
VCXG-204C	■	■	■	■	■	■	■	■	■	■	■
VCXG-241C/.I/.I.XT	■	■	■	■	■	■	■	■	■	■	■

7.11.13.2 VCXU / .XC

Camera Type	Mono8	Mono10	Mono12	Mono12p	Bayer RG8	Bayer RG10	Bayer RG12	Bayer RG12p	RGB8	BGR8
Monochrome										
VCXU-02M	■	■	■	■	□	□	□	□	□	□
VCXU-04M	■	■	■	■	□	□	□	□	□	□
VCXU-13M	■	■	□	□	□	□	□	□	□	□
VCXU-15M	■	■	■	■	□	□	□	□	□	□
VCXU-22M.R	■	■	■	■	□	□	□	□	□	□
VCXU-23M	■	■	■	■	□	□	□	□	□	□
VCXU-24M	■	■	■	■	□	□	□	□	□	□
VCXU-25M / .XC	■	■	□	□	□	□	□	□	□	□
VCXU-31M	■	■	■	■	□	□	□	□	□	□
VCXU-32M	■	■	■	■	□	□	□	□	□	□
VCXU-50M	■	■	■	■	□	□	□	□	□	□
VCXU-50MP	■	■	■	■	□	□	□	□	□	□
VCXU-51M	■	■	■	■	□	□	□	□	□	□
VCXU-53M	■	■	□	□	□	□	□	□	□	□
VCXU-65M.R	■	■	■	■	□	□	□	□	□	□
VCXU-90M	■	■	■	■	□	□	□	□	□	□
VCXU-91M	■	■	■	■	□	□	□	□	□	□
VCXU-123M	■	■	■	■	□	□	□	□	□	□
VCXU-124M	■	■	■	■	□	□	□	□	□	□
VCXU-125M.R	■	■	■	■	□	□	□	□	□	□
VCXU-201M.R	■	■	■	■	□	□	□	□	□	□

Camera Type	Mono8	Mono10	Mono12	Mono12p	Bayer RG8	Bayer RG10	Bayer RG12	Bayer RG12p	RGB8	BGR8
Color										
VCXU-02C	■	■	□	□	■	■	□	□	■	■
VCXU-04C	■	■	■	■	■	■	■	■	■	■
VCXU-13C	■	■	□	□	■	■	□	□	■	■
VCXU-15C	■	■	■	■	■	■	■	■	■	■
VCXU-22C.R	■	■	■	■	■	■	■	■	■	■
VCXU-23C	■	■	■	■	■	■	■	■	■	■
VCXU-24C	■	■	■	■	■	■	■	■	■	■

VCXU-25C	■	■	□	□	■	■	□	□	■	■
VCXU-31C	■	■	■	■	■	■	■	■	■	■
VCXU-32C	■	■	■	■	■	■	■	■	■	■
VCXU-50C	■	■	■	■	■	■	■	■	■	■
VCXU-51C	■	■	■	■	■	■	■	■	■	■
VCXU-53C	■	■	□	□	■	■	□	□	■	■
VCXU-65C.R	■	■	■	■	■	■	■	■	■	■
VCXU-90C	■	■	■	■	■	■	■	■	■	■
VCXU-91C	■	■	■	■	■	■	■	■	■	■
VCXU-123C	■	■	■	■	■	■	■	■	■	■
VCXU-124C	■	■	■	■	■	■	■	■	■	■
VCXU-125C.R	■	■	■	■	■	■	■	■	■	■
VCXU-201C.R	■	■	■	■	■	■	■	■	■	■

7.11.14 ReverseX (mono cameras / pixel formats only)

Flip horizontally the image sent by the device. The Region of interest is applied before the flipping.

Notice

The camera must be stopped before this feature can be set.

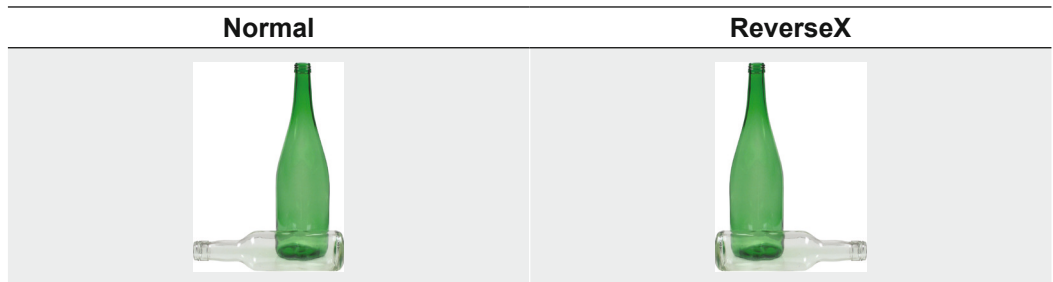

Name	ReverseX
Category	ImageFormatControl
Interface	IBoolean
Access	Read / Write
Unit	-
Values	true = 1 (On) false = 0 (Off)

7.11.15 ReverseY (monochrome cameras / pixel formats only)

Flip vertically the image sent by the device. The Region of interest is applied before the flipping.

Notice

The camera must be stopped before this feature can be set.



Name	ReverseY
Category	ImageFormatControl
Interface	IBoolean
Access	Read / Write
Unit	-
Values	true = 1 (On) false = 0 (Off)

7.11.16 SensorHeight

Effective height of the sensor in pixels.

Name	SensorHeight
Category	ImageFormatControl
Interface	IInteger
Access	Read only
Unit	-
Values	0 ... 65535 (Increment: 1)

7.11.17 SensorName (≥ Release 3 only)

Product name of the imaging Sensor.

Name	SensorName
Category	ImageFormatControl
Interface	IString
Access	Read only
Unit	-
Values	e. g. IMX174

7.11.18 SensorPixelHeight (≥ Release 3 only)

Physical size (pitch) in the y direction of a photo sensitive pixel unit.

Name	SensorPixelHeight
Category	ImageFormatControl
Interface	IFloat
Access	Read only
Unit	um
Values	0.000000 ... 255.000000 (Increment: 1)

7.11.19 SensorPixelWidth (≥ Release 3 only)

Physical size (pitch) in the x direction of a photo sensitive pixel unit.

Name	SensorPixelWidth
Category	ImageFormatControl
Interface	IFloat
Access	Read only
Unit	um
Values	0.000000 ... 255.000000 (Increment: 1)

7.11.20 SensorShutterMode

Sets the sensor shutter mode of the camera. The sensor shutter mode depends on the Trigger Mode.

Name	SensorShutterMode	
Category	ImageFormatControl	
Interface	IEnumeration	
Access	Read / Write	
Unit	-	
Values	GlobalReset	The shutter opens at the same time for all pixels but ends in a sequential manner. The pixels are exposed for different lengths of time.
	Rolling	The shutter opens and closes sequentially for groups (typically lines) of pixels. All the pixels are exposed for the same length of time but not at the same time.
	Global	The shutter opens and closes at the same time for all pixels. All the pixels are exposed for the same length of time at the same time.

VCXG / VCXU (only cameras with rolling shutter sensors)

Camera Type (Sensor)	Trigger Mode = On		Trigger Mode = Off	
	Shutter Mode	Readout Mode	Shutter Mode	Readout Mode
Monochrome / Color				
VCXG-22M.R	Global Reset	Non-overlapped	Global Reset	Non-overlapped
VCXG-22C.R	Rolling	Non-overlapped	Rolling	Overlapped
VCXU-22M.R	Global Reset	Non-overlapped	Global Reset	Non-overlapped
VCXU-22C.R	Rolling	Non-overlapped	Rolling	Overlapped
VCXG-65M.R	Global Reset	Non-overlapped	Global Reset	Non-overlapped
VCXG-65C.R	Rolling	Non-overlapped	Rolling	Overlapped
VCXU-65M.R	Global Reset	Non-overlapped	Global Reset	Non-overlapped
VCXU-65C.R	Rolling	Non-overlapped	Rolling	Overlapped
VCXG-201M.R / .I/.I.XT	Global Reset	Non-overlapped	Global Reset	Non-overlapped
VCXG-201C.R / .I/.I.XT	Rolling	Non-overlapped	Rolling	Overlapped
VCXG-125M.R	Global Reset	Non-overlapped	Global Reset	Non-overlapped
VCXG-125C.R	Rolling	Non-overlapped	Rolling	Overlapped
VCXU-125M.R	Global Reset	Non-overlapped	Global Reset	Non-overlapped
VCXU-125C.R	Rolling	Non-overlapped	Rolling	Overlapped
VCXU-201M.R	Global Reset	Non-overlapped	Global Reset	Non-overlapped
VCXU-201C.R	Rolling	Non-overlapped	Rolling	Overlapped

Global Reset

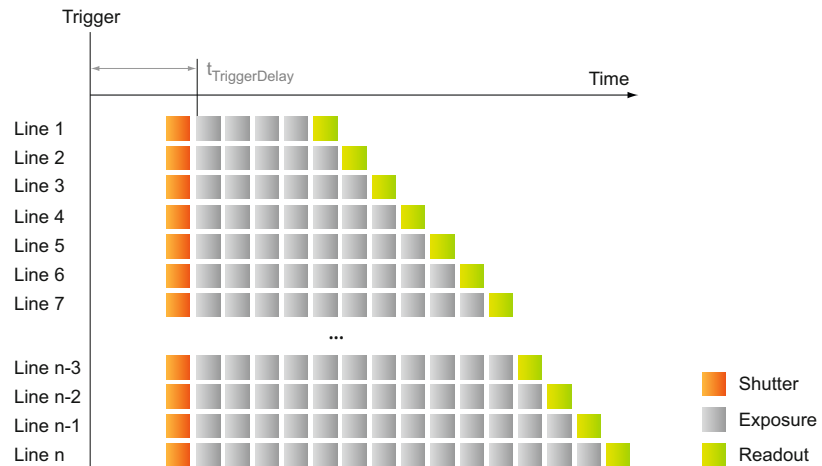

For cameras with rolling shutter sensor and set shutter mode Global Reset, for each frame all of the lines start exposure at the same time but the end of exposure is delayed by the offset of the previous line's readout. The exposure time for each line gradually lengthens. Data readout for each line begins immediately following the line's exposure. The readout time for each line is the same, but the start and end times are staggered.

An advantage of this shutter mode is a reduction in image artifacts typical of rolling shutters. However, because exposure lengthens throughout the frame, there may be a gradual increase in brightness from top to bottom of an image.

Rolling Shutter

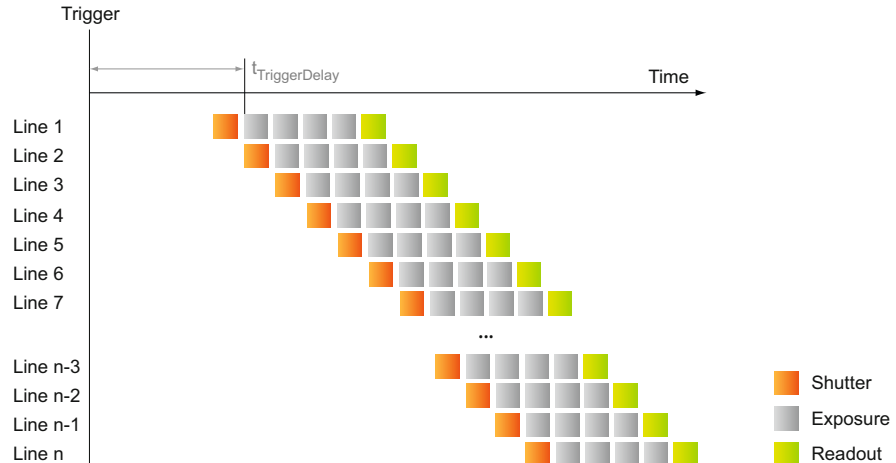

For cameras with rolling shutter sensor and set shutter mode Rolling Shutter, for each frame each line begins exposure at an offset equal to each line's readout time. The exposure time for each line is the same, but the start and end times are staggered. Data readout for each line begins immediately following the line's exposure. The readout time for each line is the same, but the start and end times are staggered.

One advantage of a Rolling Shutter is increased sensitivity. However, because exposure starts at different times throughout the frame, there are known artifacts such as skew, wobble, and partial exposure.

Notice

Due to technical issues of rolling shutter, a flash control depending on the exposure time does not make sense.

Such cameras should be used in a continuously illuminated environment.

7.11.21 SensorWidth

Effective width of the sensor in pixels.

Name	SensorWidth
Category	ImageFormatControl
Interface	IInteger
Access	Read only
Unit	-
Values	0 ... 65535 (Increment: 1)

7.11.22 TestPattern

Selects the type of test pattern that is generated by the device as image source.

Name	TestPattern
Category	ImageFormatControl
Interface	IEnumeration
Access	Read / Write
Unit	-
Values	see table below

GreyDiagonalRamp	Image is filled diagonally with an image that goes from the darkest possible value to the brightest.
GreyDiagonalRampHorizontalAndVerticalLineMoving	Image is filled diagonally with an image that goes from the darkest possible value to the brightest with moving horizontal and vertical lines.
GreyDiagonalRampHorizontalLineMoving	Image is filled diagonally with an image that goes from the darkest possible value to the brightest with moving horizontal lines.
GreyDiagonalRampVerticalLineMoving	Image is filled diagonally with an image that goes from the darkest possible value to the brightest with moving vertical lines.
GreyHorizontalRamp	Image is filled horizontally with an image that goes from the darkest possible value to the brightest.
GreyHorizontalRampHorizontalAndVerticalLineMoving	Image is filled horizontally with an image that goes from the darkest possible value to the brightest with moving horizontal and vertical lines.
GreyHorizontalRampHorizontalLineMoving	Image is filled horizontally with an image that goes from the darkest possible value to the brightest with moving horizontal lines.
GreyHorizontalRampVerticalLineMoving	Image is filled horizontally with an image that goes from the darkest possible value to the brightest with moving vertical lines.
GreyVerticalRamp	Image is filled vertically with an image that goes from the darkest possible value to the brightest.
GreyVerticalRampHorizontalAndVerticalLineMoving	Image is filled vertically with an image that goes from the darkest possible value to the brightest with moving horizontal and vertical lines.

GreyVerticalRampHorizontalLineMoving	Image is filled vertically with an image that goes from the darkest possible value to the brightest with moving horizontal lines.
GreyVerticalRampVerticalLineMoving	Image is filled vertically with an image that goes from the darkest possible value to the brightest with moving vertical lines.
HorizontalAndVerticalLineMoving	Image is filled with moving horizontal and vertical lines.
HorizontalLineMoving	Image is filled with moving horizontal lines.
Off	Image is coming from the sensor.
VerticalLineMoving	Image is filled with moving vertical lines.

7.11.23 TestPatternGeneratorSelector

Selects which test pattern generator is controlled by the *TestPattern* feature.

Name	TestPatternGeneratorSelector	
Category	ImageFormatControl	
Interface	IEnumeration	
Access	Read / Write	
Unit	-	
Values	ImageProcessor	TestPattern feature will control the image processor.
	Sensor Processor	TestPattern feature will control the sensor processor.

7.11.24 Width

Width of the image provided by the device (in pixels).

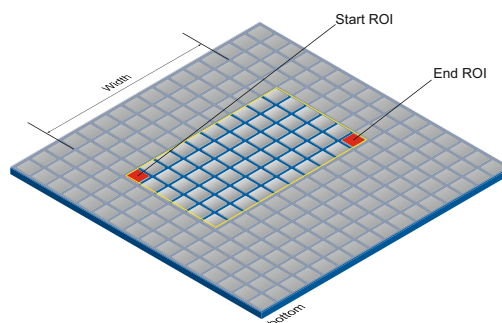

Name	Width
Category	ImageFormatControl
Interface	IInteger
Access	Read / Write
Unit	-
Values	see tables below

7.11.24.1 VCXG / .XC / .I / .I.XT / .PTP / .I.PTP

Camera Type	Values
Monochrome	
VCXG-02M	24 ... 640 (Increment: 8)
VCXG-03SWIR.XC	16 ... 656 (Increment: 16)
VCXG-04M	16 ... 720 (Increment: 16)
VCXG-13M / .I/.I.XT	24 ... 1280 (Increment: 8)
VCXG-13NIR	24 ... 1280 (Increment: 8)
VCXG-14SWIR.XC	16 ... 1296 (Increment: 16)
VCXG-15M / .I/.I.XT	16 ... 1440 (Increment: 32)
VCXG-22M.R	16 ... 1920 (Increment: 16)
VCXG-23M	16 ... 1920 (Increment: 16)
VCXG-24M	16 ... 1920 (Increment: 16)
VCXG-25M / .I/.I.XT	48 ... 1920 (Increment: 16)
VCXG-32M / .I/.I.XT/.PTP/.I.PTP	16 ... 2048 (Increment: 16)
VCXG-50MP	16 ... 2448 (Increment: 16)
VCXG-51M / .XC/.I/.I.XT/.PTP/.I.PTP	16 ... 2448 (Increment: 16)
VCXG-53M / .I/.I.XT	48 ... 2592 (Increment: 16)
VCXG-53NIR	48 ... 2592 (Increment: 16)
VCXG-65M.R	16 ... 3072 (Increment: 16)
VCXG-82M / .I/.I.XT	32 ... 2848 (Increment: 32)
VCXG-91M	16 ... 4096 (Increment: 16)
VCXG-124M / .I/.I.XT/.PTP/.I.PTP	16 ... 4096 (Increment: 16)
VCXG-125M.R	16 ... 4000 (Increment: 16)
VCXG-127M / .I/.I.XT	32 ... 4096 (Increment: 32)
VCXG-201M.R / .I/.I.XT	32 ... 5472 (Increment: 32)
VCXG-204M	32 ... 4480 (Increment: 32)
VCXG-241M / .I/.I.XT	32 ... 5312 (Increment: 32)
Color	
VCXG-02C	24 ... 640 (Increment: 8)
VCXG-04C	16 ... 720 (Increment: 16)
VCXG-13C / .I/.I.XT	24 ... 1280 (Increment: 8)
VCXG-15C / .I/.I.XT	16 ... 1440 (Increment: 32)
VCXG-22C.R	16 ... 1920 (Increment: 16)
VCXG-23C	16 ... 1920 (Increment: 16)
VCXG-24C	16 ... 1920 (Increment: 16)
VCXG-25C / .I/.I.XT	48 ... 1920 (Increment: 16)
VCXG-32C / .I/.I.XT/.PTP/.I.PTP	16 ... 2048 (Increment: 16)
VCXG-51C / .I/.I.XT/.PTP/.I.PTP	16 ... 2448 (Increment: 16)
VCXG-53C / .I/.I.XT	48 ... 2592 (Increment: 16)
VCXG-65C.R	16 ... 3072 (Increment: 16)
VCXG-82C / .I/.I.XT	32 ... 2848 (Increment: 32)
VCXG-91C	16 ... 4096 (Increment: 16)
VCXG-124C / .I/.I.XT/.PTP/.I.PTP	16 ... 4096 (Increment: 16)
VCXG-125C.R	16 ... 4000 (Increment: 16)
VCXG-127C / .I/.I.XT	32 ... 4096 (Increment: 32)
VCXG-201C.R / .I/.I.XT	32 ... 5472 (Increment: 32)
VCXG-204C	32 ... 4480 (Increment: 32)
VCXG-241C / .I/.I.XT	32 ... 5312 (Increment: 32)

7.11.24.2 VCXU / .XC

Camera Type	Values
Monochrome	
VCXU-02M	24 / 32* ... 640 (Increment: 8 / 16*)
VCXU-04M	16 ... 720 (Increment: 16)
VCXU-13M	24 / 32* ... 1280 (Increment: 8 / 16*)
VCXU-15M	16 ... 1440 (Increment: 32)
VCXU-22M.R	16 ... 1920 (Increment: 16)
VCXU-23M	16 ... 1920 (Increment: 16)
VCXU-24M	16 ... 1920 (Increment: 16)
VCXU-25M / .XC	48 ... 1920 (Increment: 16)
VCXU-31M	16 ... 2048 (Increment: 16)
VCXU-32M	16 ... 2048 (Increment: 16)
VCXU-50M	16 ... 2448 (Increment: 16)
VCXU-50MP	16 ... 2448 (Increment: 16)
VCXU-51M	16 ... 2448 (Increment: 16)
VCXU-53M	48 ... 2592 (Increment: 16)
VCXU-65M.R	16 ... 3072 (Increment: 16)
VCXU-90M	16 ... 4096 (Increment: 16)
VCXU-91M	16 ... 4096 (Increment: 16)
VCXU-123M	16 ... 4096 (Increment: 16)
VCXU-124M	16 ... 4096 (Increment: 16)
VCXU-125M.R	16 ... 4000 (Increment: 16)
VCXU-201M.R	16 ... 5472 (Increment: 16)
Color	
VCXU-02C	24 / 32* ... 640 (Increment: 8 / 16*)
VCXU-04C	16 ... 720 (Increment: 16)
VCXU-13C	24 / 32* ... 1280 (Increment: 8 / 16*)
VCXU-15C	16 ... 1440 (Increment: 32)
VCXU-22C.R	16 ... 1920 (Increment: 16)
VCXU-23C	16 ... 1920 (Increment: 16)
VCXU-24C	16 ... 1920 (Increment: 16)
VCXU-25C	48 ... 1920 (Increment: 16)
VCXU-31C	16 ... 2048 (Increment: 16)
VCXU-32C	16 ... 2048 (Increment: 16)
VCXU-50C	16 ... 2448 (Increment: 16)
VCXU-51C	16 ... 2448 (Increment: 16)
VCXU-53C	48 ... 2592 (Increment: 16)
VCXU-65C.R	16 ... 3072 (Increment: 16)
VCXU-90C	16 ... 4096 (Increment: 16)
VCXU-91C	16 ... 4096 (Increment: 16)
VCXU-123C	16 ... 4096 (Increment: 16)
VCXU-124C	16 ... 4096 (Increment: 16)
VCXU-125C.R	16 ... 4000 (Increment: 16)
VCXU-201C.R	16 ... 5472 (Increment: 16)

*) ≥ Release 3

7.11.25 WidthMax

Maximum width of the image (in pixels). The dimension is calculated after horizontal binning, decimation or any other function changing the horizontal dimension of the image.

Name	WidthMax
Category	ImageFormatControl
Interface	Integer
Access	Read only
Unit	-
Values	Resolution of the sensor in X-direction. (see tables below)

7.11.25.1 VCXG /.XC / .I / .I.XT / .PTP / .I.PTP

Camera Type	Values
Monochrome	
VCXG-02M	640
VCXG-03SWIR.XC	656
VCXG-04M	720
VCXG-13M / .I/.I.XT	1280
VCXG-13NIR	1280
VCXG-14SWIR.XC	1296
VCXG-15M / .I/.I.XT	1440
VCXG-22M.R	1920
VCXG-23M	1920
VCXG-24M	1920
VCXG-25M / .I/.I.XT	1920
VCXG-32M / .I/.I.XT/.PTP/.I.PTP	2048
VCXG-50MP	2448
VCXG-51M/.XC.I/.I.XT/.PTP/.I.PTP	2448
VCXG-53M / .I/.I.XT	2592
VCXG-53NIR	2592
VCXG-65M.R	3072
VCXG-82M / .I/.I.XT	2848
VCXG-91M	4096
VCXG-124M / .I/.I.XT/.PTP/.I.PTP	4096
VCXG-125M.R	4000
VCXG-127M / .I/.I.XT	4096
VCXG-201M.R / .I/.I.XT	5472
VCXG-204M	4480
VCXG-241M / .I/.I.XT	5312

Camera Type	Values
Color	
VCXG-02C	640
VCXG-04C	720
VCXG-13C / .I/.I.XT	1280
VCXG-15C / .I/.I.XT	1440
VCXG-22C.R	1920
VCXG-23C	1920
VCXG-24C	1920
VCXG-25C / .I/.I.XT	1920
VCXG-32C / .I/.I.XT/.PTP/.I.PTP	2048
VCXG-51C / .I/.I.XT/.PTP/.I.PTP	2448
VCXG-53C / .I/.I.XT	2592
VCXG-65C.R	3072
VCXG-82C / .I/.I.XT	2848
VCXG-91C	4096
VCXG-124C / .I/.I.XT/.PTP/.I.PTP	4096
VCXG-125C.R	4000
VCXG-127C / .I/.I.XT	4096
VCXG-201C.R / .I/.I.XT	5472
VCXG-204C	4480
VCXG-241C / .I/.I.XT	5312

7.11.25.2 VCXU / .XC

Camera Type	Values
Monochrome	
VCXU-02M	640
VCXU-04M	720
VCXU-13M	1280
VCXU-15M	1440
VCXU-22M.R	1920
VCXU-23M	1920
VCXU-24M	1920
VCXU-25M / .XC	1920
VCXU-31M	2048
VCXU-32M	2048
VCXU-50M	2448
VCXU-50MP	2448
VCXU-51M	2448
VCXU-53M	2592
VCXU-65M.R	3072
VCXU-90M	4096
VCXU-91M	4096
VCXU-123M	4096
VCXU-124M	4096
VCXU-125M.R	4000
VCXU-201M.R	5472

Camera Type	Values
Color	
VCXU-02C	640
VCXU-04C	720
VCXU-13C	1280
VCXU-15C	1440
VCXU-22C.R	1920
VCXU-23C	1920
VCXU-24C	1920
VCXU-25C	1920
VCXU-31C	2048
VCXU-32C	2048
VCXU-50C	2448
VCXU-51C	2448
VCXU-53C	2592
VCXU-65C.R	3072
VCXU-90C	4096
VCXU-91C	4096
VCXU-123C	4096
VCXU-124C	4096
VCXU-125C.R	4000
VCXU-201C.R	5472

7.11.26 boOpticalBlackPixelsConfigurationMode (SWIR only)

Controls if the optical black pixels configuration mode is active. Enables extended sensor width to display the optical black pixels in every line.

Notice

The camera must be stopped before this feature can be edited.

Instruction

1. Open the camera in *Camera Explorer*.
2. Stop the Image acquisition.
3. Set the *boOpticalBlackPixelsConfigurationMode* to *On*.
-> *WidthMax* is increased to 752 (VCXG-03SWIR.XC) / 1392 (VCXG-14SWIR.XC)
4. Adjust the value for *Width*.
5. Start the Image acquisition.
-> The set number of black pixels is displayed on the right side of each image line.

Name	boOpticalBlackPixelsConfigurationMode	
Category	ImageFormatControl	
Interface	IEnumeration	
Access	Read / Write	
Unit	-	
Values	On	Enables black pixels configuration mode.
	Off	Disables black pixels configuration mode.

7.11.27 boOpticalBlackPixelsWidth (SWIR only)

Width of the optical black image area (in pixels).

Name	boOpticalBlackPixelsWidth
Category	ImageFormatControl
Interface	Integer
Access	Read only
Unit	-
Values	96

7.12 ImageProcessingControl (SWIR only)

Category that contains the Baumer image processing features.

Dynamic Pixel Correction - General Information

The camera is equipped with *Dynamic Pixel Correction* to correct deviating pixels. In contrast to the correction of static defect pixels, the correction is dynamic. This means that the pixels to be corrected depend on the image and the coordinates of the pixels are not saved in any list.

Calculation

- The values of the neighboring pixels on the left and the right side of the deviating pixels, will be read out.
- Then the average value of these pixels is determined to correct the first deviating pixel
- Finally, the value of the deviating pixel is corrected by using the previously corrected pixel and the pixel of the other side of the deviating pixel (not shown in the image).

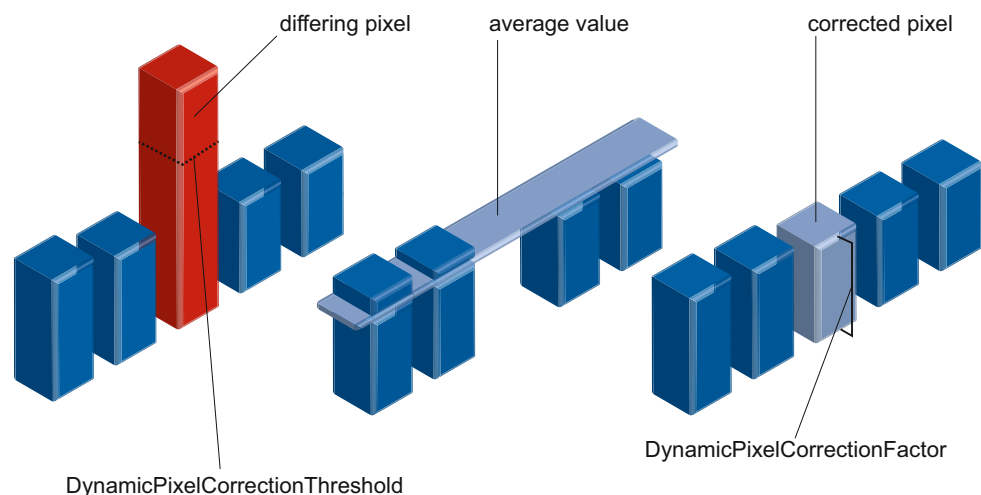

7.12.1 DynamicPixelCorrectionEnable

Enables dynamic pixel correction. .

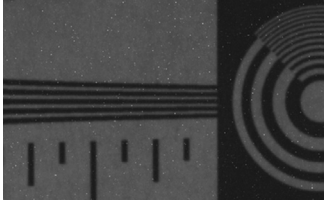

DynamicPixelCorrection = Off



DynamicPixelCorrection = On

Name	DynamicPixelCorrectionEnable
Category	ImageProcessingControl
Interface	IBoolean
Access	Read / Write
Unit	-
Values	true = 1 (On) false = 0 (Off)

7.12.2 DynamicPixelCorrectionFactor

Sets the factor for dynamic pixel correction. The pixel is adapted to its surroundings by this set factor.

Notice

Set up the ambient conditions (lighting) as in the planned application. Select the settings so that only the desired pixels in the image are corrected.

Name	DynamicPixelCorrectionFactor
Category	ImageProcessingControl
Interface	IFloat
Access	Read / Write
Unit	-
Values	1.0 ... 2.5 (Increment: 0.5)

7.12.3 DynamicPixelCorrectionThreshold

Sets the threshold value from which deviation from its surroundings a pixel is evaluated as a pixel to be corrected.

Notice

Set up the ambient conditions (lighting) as in the planned application. Select the settings so that only the desired pixels in the image are corrected.

Name	DynamicPixelCorrectionThreshold
Category	ImageProcessingControl
Interface	Integer
Access	Read / Write
Unit	-
Values	0 ... 255 (Increment: 1)

7.13 Category: LUTControl

Features in this chapter describe the Look-up table (LUT) related features. For LUT related features, certain values are stored in the camera. This includes the coordinates of defective pixels so that they can be corrected.

General information (Static Pixel Correction)

There is a certain probability of abnormal pixels – so-called defect pixels – occurring within sensors from all manufacturers. The charge quantity of these pixels is not linearly dependent on the exposure time.

The occurrence of these defect pixels is unavoidable and intrinsic to the manufacturing and aging process of the sensors.

The operation of the camera is not affected by these pixels. They only appear as brighter (warm pixel) or darker (cold pixel) spots on the recorded image.

Distinction of "hot" and "cold" pixels within the recorded image.

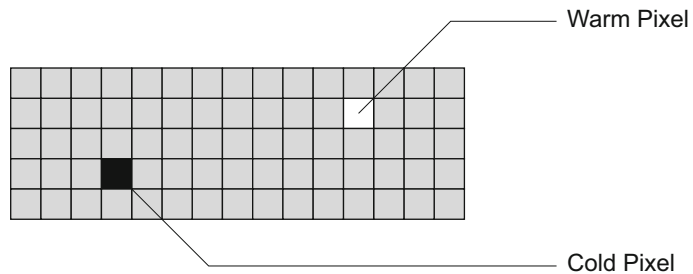

Charge quantity of "hot" and "cold" pixels compared with "normal" pixels:

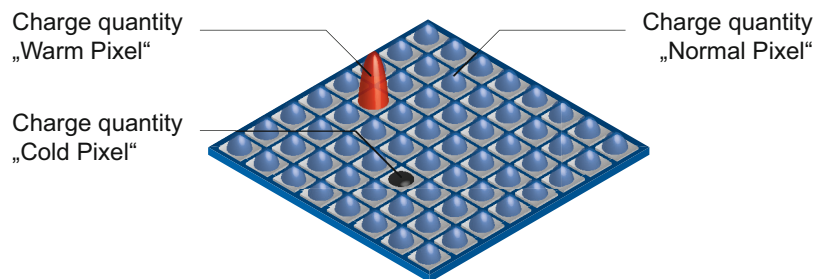

Correction Algorithm (Pixel Correction)

On Baumer cameras the problem of defect pixels is solved as follows:

- Possible defect pixels are identified during the production process of the camera.
- The coordinates of these pixels are stored in the factory settings of the camera.
- Once the sensor readout is completed, correction takes place:
 - Before any other processing, the values of the neighboring pixels on the left and the right side of the defect pixels, will be read out. (within the same bayer phase for color)
 - Then the average value of these 2 pixels is determined to correct the first defect pixel
 - Finally, the value of the defect pixel is corrected by using the previously corrected pixel and the pixel of the other side of the defect pixel.

Examples for the correction of defect pixels

1 defect pixel

Actual state: 7 12 99 8 13 8

Correction

Step 1: 7 12 10 8 13 8

Example 1

2 defect pixel

Actual state: 7 12 99 99 13 8

Correction

Step 1: 7 12 10 13 8

Step 2: 7 12 7 10 8

Example 1

Actual state: 7 12 99 8 98 8 5

Correction

Step 1: 7 12 7 8 98 8 5

Step 2: 7 12 7 8 8 5

Example 2

3 defect pixel

Actual state: 7 12 99 99 98 8 5

Correction

Step 1: 7 12 7 99 98 8 5

Step 2: 7 12 7 10 8 5

Step 3: 7 12 7 10 6 8 5

Example 1

Actual state: 7 12 99 8 98 8 68 18 15

Correction

Step 1: 7 12 7 8 98 8 68 18 15

Step 2: 7 12 7 8 7 8 68 18 15

Step 3: 7 12 7 8 7 8 11 10 15

Legend:
 cyan: defect pixel
 red: corrected pixel (red)
 green: corrected pixel (green)

General Information (Defect Pixel List)

As stated previously, this list is determined during the camera's production and stored in the factory settings.

Additional hot or cold pixels can develop during the lifecycle of a camera. If this happens, Baumer gives you the option to add their coordinates to the defect pixel list.

You can determine the coordinates¹⁾ of the affected pixels and add them to the list. Once the defect pixel list is stored in the flash memory of the camera, pixel correction is carried out for all coordinates on the defect pixel list.

Notice

There are defect pixels, which occur only under certain environmental parameters. These include temperatures or exposure settings.

Complete defect pixels that occur in your application.

1) Position in relation to full frame format (raw data format)

Add Defect Pixel to Defect Pixel List with Baumer Camera Explorer

Notice

The addition of defect pixels must be done in FullFrame (without *Binning*, without *Width / Height / OffsetX / OffsetY*), in raw data format and without activated color calculation.

1. Start the *Camera Explorer*. Connect to the camera. Select the profile *GenICam Guru*.
2. Open the category *LUT Control*.
3. Locate an empty *Defect Pixel List Index*.
Defect Pixel List Entry PosX = 0
Defect Pixel List Entry PosY = 0
Avoid using existing coordinates!
4. Determine the coordinates of the defect pixel. Keep the mouse pointer over the defect pixel. The coordinates of the defect pixel is displayed in the status bar.
For simplification, you can enlarge the image.
5. Enter the determined coordinates for X (*Defect Pixel List Entry PosX*) and Y (*Defect Pixel List Entry PosY*).
6. Activate the registered *Defect Pixel List Index* (*Defect Pixel List Entry Active* = *True*).
7. Stop the camera and start them again to take over the updated coordinates.

7.13.1 DefectPixelCorrection

Enable the correction of defect pixels.

Name	DefectPixelCorrection
Category	LUTControl
Interface	IBoolean
Access	Read / Write
Unit	-
Values	true = 1 (On) false = 0 (Off)

7.13.2 DefectPixelListEntryActive

Determines if the pixel correction is active for the selected entry.

Name	DefectPixelListEntryActive
Category	LUTControl
Interface	IBoolean
Access	Read / Write
Unit	-
Values	true = 1 (On) false = 0 (Off)

7.13.3 DefectPixelListEntryPosX

X position of the defect pixel.

Name	DefectPixelListEntryPosX
Category	LUTControl
Interface	Integer
Access	Read / Write
Unit	-
Values	0 ... Resolution of the sensor in X-direction. (Increment: 1)

7.13.4 DefectPixelListEntryPosY

Y position of the defect pixel.

Name	DefectPixelListEntryPosY
Category	LUTControl
Interface	Integer
Access	Read / Write
Unit	-
Values	0 ... Resolution of the sensor in Y-direction. (Increment: 1)

7.13.5 DefectPixelListIndex

Index to the pixel correction list.

Name	DefectPixelListIndex
Category	LUTControl
Interface	Integer
Access	Read / Write
Unit	-
Values	0 ... 511 (Increment: 1) SWIR only: 0 ... 8166 (Increment: 1)

7.13.6 DefectPixelListSelector

Selects which Defect Pixel List to control.

Name	DefectPixelListSelector
Category	LUTControl
Interface	Enumeration
Access	Read / Write
Unit	-
Values	Pixel Selects Defect Pixel List for defect pixels.

7.13.7 Fixed Pattern Noise Correction (FPNC)

CMOS sensors exhibit nonuniformities that are called *Fixed Pattern Noise* (FPN). However it is no noise but a fixed variation from pixel to pixel that can be corrected. The advantage of using this correction is a more homogeneous picture which may simplify the image analysis. Variations from pixel to pixel of the dark signal are called dark signal nonuniformity (DSNU) whereas photo response nonuniformity (PRNU) describes variations of the sensitivity. DSNU is corrected via an offset while PRNU is corrected by a factor.

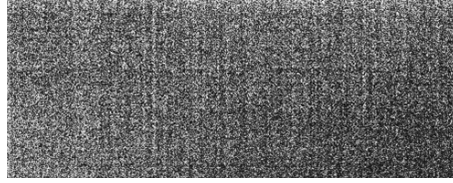

FPN Correction Off

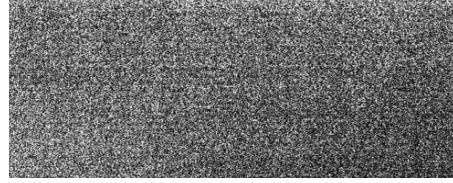

FPN Correction On

Name	Fixed Pattern Noise Correction
Category	LUTControl
Interface	IBoolean
Access	Read / Write
Unit	-
Values	true = 1 (On) false = 0 (Off)

7.13.7.1 VCXG /.XC / .I / .I.XT / .PTP / .I.PTP

Notice

On cameras with Sony sensors additional FPN correction is not necessary.

Camera Type	FPNC
Monochrome	
VCXG-02M	<input checked="" type="checkbox"/>
VCXG-03SWIR.XC	<input type="checkbox"/>
VCXG-04M	<input type="checkbox"/>
VCXG-13M/.I/.I.XT	<input checked="" type="checkbox"/>
VCXG-13NIR	<input checked="" type="checkbox"/>
VCXG-14SWIR.XC	<input type="checkbox"/>
VCXG-15M/.I/.I.XT	<input type="checkbox"/>
VCXG-22M.R	<input type="checkbox"/>
VCXG-23M	<input type="checkbox"/>
VCXG-24M	<input type="checkbox"/>
VCXG-25M / .I/.I.XT	<input checked="" type="checkbox"/>
VCXG-32M/.I/.I.XT/.PTP/.I.PTP	<input type="checkbox"/>
VCXG-50MP	<input type="checkbox"/>
VCXG-51M/.XC/.I/.I.XT/.PTP/.I.PTP	<input type="checkbox"/>
VCXG-53M/.I/.I.XT	<input checked="" type="checkbox"/>
VCXG-53NIR	<input checked="" type="checkbox"/>
VCXG-65M.R	<input type="checkbox"/>
VCXG-82M/.I/.I.XT	<input type="checkbox"/>
VCXG-91M	<input type="checkbox"/>
VCXG-124M/.I/.I.XT/.PTP/.I.PTP	<input type="checkbox"/>
VCXG-127M/.I/.I.XT	<input type="checkbox"/>
VCXG-125M.R	<input type="checkbox"/>
VCXG-204M	<input type="checkbox"/>
VCXG-201M.R/.I/.I.XT	<input type="checkbox"/>
VCXG-241M/.I/.I.XT	<input type="checkbox"/>

Camera Type	FPNC
Color	
VCXG-02C	■
VCXG-04C	□
VCXG-13C / .I/.I.XT	■
VCXG-15C / .I/.I.XT	□
VCXG-22C.R	□
VCXG-23C	□
VCXG-24C	□
VCXG-25C / .I/.I.XT	■
VCXG-32C / .I/.I.XT/.PTP/.I.PTP	□
VCXG-51C / .I/.I.XT/.PTP/.I.PTP	□
VCXG-53C / .I/.I.XT	■
VCXG-65C.R	□
VCXG-82C / .I/.I.XT	□
VCXG-91C	□
VCXG-124C / .I/.I.XT/.PTP/.I.PTP	□
VCXG-125C.R	□
VCXG-127C / .I/.I.XT	□
VCXG-201C.R / .I/.I.XT	□
VCXG-204C	□
VCXG-241C / .I/.I.XT	□

7.13.7.2 VCXU / .XC

Camera Type	FPNC
Monochrome / Color	
VCXU-02M / VCXU-02C	■
VCXU-04M / VCXU-04C	□
VCXU-13M / VCXU-13C	■
VCXU-15M / VCXU-15C	□
VCXU-22M.R / VCXU-22C.R	□
VCXU-23M / VCXU-23C	□
VCXU-24M / VCXU-24C	□
VCXU-25M / .XC / VCXU-25C	■
VCXU-31M / VCXU-31C	□
VCXU-32M / VCXU-32C	□
VCXU-50MP	□
VCXU-50M / VCXU-50C	□
VCXU-51M / VCXU-51C	□
VCXU-53M / VCXU-53C	■
VCXU-65M.R / VCXU-65C.R	□
VCXU-90M / VCXU-90C	□
VCXU-91M / VCXU-91C	□
VCXU-123M / VCXU-123C	□
VCXU-124M / VCXU-124C	□
VCXU-125M.R / VCXU-125C.R	□
VCXU-201M.R / VCXU-201C.R	□

Notice
On cameras with Sony sensors additional FPN correction is not necessary.

7.13.8 LUTContent

Describes the content of the selected LUT.

Name	LUTContent	
Category	LUTControl	
Interface	IEnumeration	
Access	Read / Write	
Unit	-	
Values	Gamma	The content of the selected LUT is defined by the value of the feature Gamma.
	Userdefined LUT	The content of the selected LUT is user defined.

7.13.9 LUTEnable

Activates the selected The Look-Up-Table (LUT) The LUT is employed on Baumer mono-chrome and color cameras. It contains 2^{12} (4096) values for the available levels. These values can be adjusted by the user.

For color cameras the LUT is applied for all color channels together.

Name	LUTEnable
Category	LUTControl
Interface	IBoolean
Access	Read / Write
Unit	-
Values	true = 1 (On)
	false = 0 (Off)

7.13.10 LUTIndex

Control the index (offset) of the coefficient to access in the selected LUT.

Name	DefectPixelListEntryPosX
Category	LUTControl
Interface	IInteger
Access	Read / Write
Unit	-
Values	0 ... 4095 (Increment: 1)

7.13.11 LUTSelector

Selects which LUT to control.

Name	LUTContent
Category	LUTControl
Interface	IEnumeration
Access	Read / Write
Unit	-
Values	Luminance Selects the Luminance LUT.

7.13.12 LUTValue

Returns the Value at entry LUTIndex of the LUT selected by LUTSelector.

Name	LUTValue
Category	LUTControl
Interface	IInteger
Access	Read / Write
Unit	-
Values	0 ... 4095 (Increment: 1)

7.14 Category: MemoryManagement (≥ Rel. 3 only)

Category to support the cameras buffer management in memory.

7.14.1 MemoryMaxBlocks

Maximum count of disposal memory blocks.

Name	MemoryMaxBlocks
Category	MemoryManagement
Interface	IInteger
Access	Read only
Unit	-
Values	0 ... 4294967295 (Increment: 1)

7.15 Category: SequencerControl (≥ Rel. 2 only)

Category for the Sequencer Control features.

The Sequencer enables the possibility of image series recording including automated re-parameterization of the camera based on different events and signals. Therefore the desired camera settings for each step are stored in so called sequencer sets.

Stringing together a number of these sequencer sets results in a sequence. The connection of sequences is done by using different paths. Alongside the camera features the path related features are also part of a sequencer set.

Sequencer sets

Sequencer sets combine camera features – comparable with a user set – and sequencer (set and path) related parameters.

Settings for several camera features such as:

- Exposure time
- Gain
- Region of Interest (OffsetX / OffsetY / Width / Height)
- User output
- Counter

can be controlled by the sequencer and thus stored to a sequencer set as well as information for the set switch-over via four different paths.

Notice

With the Feature *SequencerFeatureSelector* you can see all available features of a Sequencer Set.

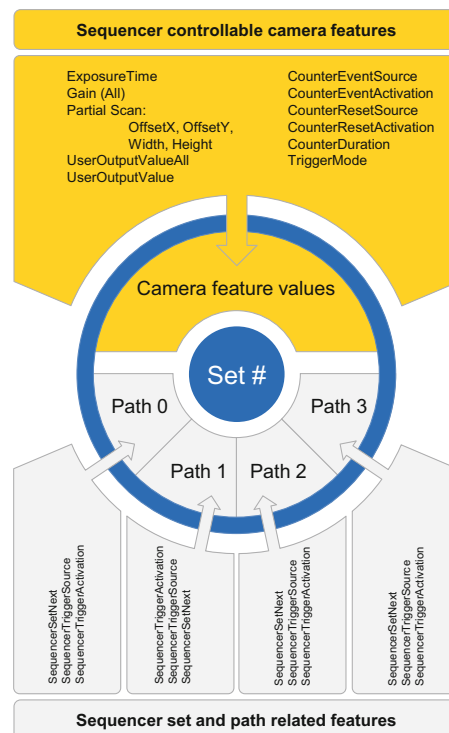

Each path involves:

- the destination for the set switch-over that is mapped by the SequencerSetNext feature
- the signal, whose change of state is used for triggering the set switch-over and that is mapped as SequencerTriggerSource
- the change of state triggering the set switch-over and that is mapped as 'Sequencer-TriggerActivation'

As with user sets the camera's current settings are overwritten once a sequencer set is loaded and the sequencer is activated.

Sequencer configuration

In order to avoid overwriting current camera settings while configuring a sequencer, the camera needs to be set to the sequencer configuration mode.

Once the camera is set to the sequencer configuration mode, the individual sequencer sets can be selected via the SequencerSetSelector, configured and saved by executing SequencerSetSave.

Starting the configured sequence requires to switch the sequencer configuration mode off and to enable the sequencer mode.

7.15.1 SequencerConfigurationMode

Controls if the sequencer configuration mode is active.

Name	SequencerConfigurationMode	
Category	SequencerControl	
Interface	IEnumeration	
Access	Read / Write	
Unit	-	
Values	On	Enables the sequencer configuration mode.
	Off	Disables the sequencer configuration mode.

7.15.2 SequencerFeatureEnable

Enables the selected feature and make it active in all the sequencer sets.

Name	SequencerFeatureEnable	
Category	SequencerControl	
Interface	IBoolean	
Access	Read only	
Unit	-	
Values	true = 1 (On)	
	false = 0 (Off)	

7.15.3 SequencerFeatureSelector

Selects the camera features that are controlled by the sequencer.

Name	SequencerFeatureSelector	
Category	SequencerControl	
Interface	IEnumeration	
Access	Read / Write	
Unit	-	
Values	CounterDuration	Sets the duration (or number of events) before the CounterEnd event is generated.
	CounterEventActivation	Selects the Activation mode Event Source signal.
	CounterEventSource	Select the events that will be the source to increment the Counter.
	CounterResetActivation	Selects the Activation mode of the Counter Reset Source signal.
	CounterResetSource	Selects the signals that will be the source to reset the Counter.
	ExposureMode	Sets the operation mode of the Exposure (or shutter).
	ExposureTime	Returns the exposure time used to capture the image.
	Gain	Controls the selected gain as an absolute physical value.
	Height	Height of the image provided by the device (in pixels).
	OffsetX	Horizontal offset from the origin to the region of interest (in pixels).
	OffsetY	Vertical offset from the origin to the region of interest (in pixels).
	TriggerMode	Controls if the selected trigger is active.
	UserOutputValue	Sets the value of the bit selected by UserOutputSelector.
	UserOutputValueAll	Sets the value of all the bits of the User Output register.
	Width	Width of the image provided by the device (in pixels).

7.15.4 SequencerMode

Controls if the sequencer mechanism is active.

Notice

To use this feature, the features *BalanceWhiteAuto* (color cameras only) and *SequencerConfigurationMode* must be off.

To write this feature, set `TLParamsLocked = 0`.

Name	SequencerMode	
Category	SequencerControl	
Interface	IEnumeration	
Access	Read / Write	
Unit	-	
Values	On	Enables the sequencer.
	Off	Disables the sequencer.

7.15.5 SequencerPathSelector

Selects the path that contains the settings coming afterward.

Name	SequencerPathSelector	
Category	SequencerControl	
Interface	IInteger	
Access	Read / Write	
Unit	-	
Values	0 ... 3 (Increment: 1)	

7.15.6 SequencerSetActive

Contains the currently active sequencer set.

Name	SequencerSetActive	
Category	SequencerControl	
Interface	IInteger	
Access	Read / Write	
Unit	-	
Values	0 ... 127 (Increment: 1)	

7.15.7 SequencerSetLoad

Loads the sequencer set selected by SequencerSetSelector in the device.

Name	SequencerSetLoad
Category	SequencerControl
Interface	ICommand
Access	Write only
Unit	-
Values	-

7.15.8 SequencerSetNext

Specifies the next sequencer set.

Name	SequencerSetNext
Category	SequencerControl
Interface	IInteger
Access	Read / Write
Unit	-
Values	0 ... 127 (Increment: 1)

7.15.9 SequencerSetSave

Saves the current device state to the sequencer set selected by the SequencerSetSelector.

Name	SequencerSetSave
Category	SequencerControl
Interface	ICommand
Access	Write only
Unit	-
Values	-

7.15.10 SequencerSetSelector

Selects the sequencer set to which further feature settings applies.

Name	SequencerSetSelector
Category	SequencerControl
Interface	IInteger
Access	Read / Write
Unit	-
Values	0 ... 127 (Increment: 1)

7.15.11 SequencerSetStart

Sets the initial/start sequencer set, which is the first set used within a sequencer.

Name	SequencerSetStart
Category	SequencerControl
Interface	Integer
Access	Read / Write
Unit	-
Values	0 ... 127 (Increment: 1)

7.15.12 SequencerTriggerActivation

Defines the signals edge that triggers the sequencer.

Name	SequencerTriggerActivation	
Category	SequencerControl	
Interface	Enumeration	
Access	Read / Write	
Unit	-	
Values	AnyEdge	Specifies that the trigger is considered valid on the falling or rising edge of the source signal.
	FallingEdge	Specifies that the trigger is considered valid on the falling edge of the source signal.
	LevelHigh*	Specifies that the trigger is considered valid as long as the level of the source signal is high.
	LevelLow*	Specifies that the trigger is considered valid as long as the level of the source signal is low.
	RisingEdge	Specifies that the trigger is considered valid on the rising edge of the source signal.

*) ≥ Release 3

7.15.13 SequencerTriggerSource

Specifies the internal signal or physical input line to use as the sequencer trigger source.

Name	SequencerTriggerSource	
Category	SequencerControl	
Interface	IEnumeration	
Access	Read / Write	
Unit	-	
Values	Off	Disables the sequencer trigger.
	Counter-1End	Starts with the reception of the Counter End.
	Counter-2End	Starts with the reception of the Counter End.
	Line0	Specifies Line 0 as external trigger source.
	Line1*	Specifies Line 1 as external trigger source.
	Line2*	Specifies Line 2 as external trigger source.
	Line3**	Specifies Line 3 as external trigger source.
	Exposure-Active	Starts with the reception of the Exposure Active.
	ReadOutActive	Starts with the reception of the Read Out Active.
	Timer1End	Starts with the reception of the Timer End.

*) ≥ Release 3

***) only VCXG.I / .XT / .PTP / .I.PTP

7.16 Category: TransportLayerControl

This chapter provides the Transport Layer control features.

7.16.1 EnergyEfficientEthernetEnable (≥ Rel. 3 only)

Controls whether the Energy Efficient / Green Ethernet mode (802.3az) in the PHY is activated or not.

Notice

A device reboot is needed for changes to take effect.

Name	EnergyEfficientEthernetEnable	
Category	TransportLayerControl	
Interface	IBoolean	
Access	Read / Write	
Unit	-	
Values	true = 1 (On)	
	false = 0 (Off)	

7.16.2 Category: TransportLayerControl → GigE Vision

Category that contains the features pertaining to the GigE Vision transport layer of the device.

7.16.2.1 GVSPConfigurationBlockID64Bit

Enables the 64 bit block ID length.

Name	GVSPConfigurationBlockID64Bit
Category	TransportLayerControl → GigE Vision
Interface	IBoolean
Access	Read only
Unit	-
Values	true = 1 (On) false = 0 (Off)

7.16.2.2 GevCCP

Controls the device access privilege of an application.

Name	GevCCP
Category	TransportLayerControl → GigE Vision
Interface	IEnumeration
Access	Read / Write
Unit	-
Values	OpenAccess Open Access. ExclusiveAccess Exclusive Access. ControlAccess Control Access.

7.16.2.3 GevCurrentDefaultGateway

Reports the default gateway IP address to be used on the given logical link.

Name	GevCurrentDefaultGateway
Category	TransportLayerControl → GigE Vision
Interface	IInteger
Access	Read only
Unit	-
Values	IP address

7.16.2.4 GevCurrentIPAddress

Reports the IP address for the given logical link.

Name	GevCurrentIPAddress
Category	TansportLayerControl → GigEVision
Interface	Integer
Access	Read only
Unit	-
Values	IP address

7.16.2.5 GevCurrentIPConfigurationDHCP

Controls whether the DHCP IP configuration scheme is activated on the given logical link.

Name	GevCurrentIPConfigurationDHCP
Category	TansportLayerControl → GigEVision
Interface	IBoolean
Access	Read / Write
Unit	-
Values	true = 1 (On) false = 0 (Off)

7.16.2.6 GevCurrentIPConfigurationLLA

Controls whether the Link Local Address IP configuration scheme is activated on the given logical link.

Name	GevCurrentIPConfigurationLLA
Category	TansportLayerControl → GigEVision
Interface	IBoolean
Access	Read only
Unit	-
Values	true = 1 (On) false = 0 (Off)

7.16.2.7 **GevCurrentIPConfigurationPersistentIP**

Controls whether the PersistentIP configuration scheme is activated on the given logical link.

Name	GevCurrentIPConfigurationPersistentIP
Category	TansportLayerControl → GigEVision
Interface	IBoolean
Access	Read / Write
Unit	-
Values	true = 1 (On) false = 0 (Off)

7.16.2.8 **GevCurrentSubnetMask**

Reports the subnet mask of the given logical link.

Name	GevCurrentSubnetMask
Category	TansportLayerControl → GigEVision
Interface	IInteger
Access	Read only
Unit	-
Values	IP address

7.16.2.9 **GevFirstURL**

Indicates the first URL to the GenICam XML device description file. The first URL is used as the first choice by the application to retrieve the GenICam XML device description file.

Name	GevFirstURL
Category	TansportLayerControl → GigEVision
Interface	IString
Access	Read only
Unit	-
Values	URL

7.16.2.10 **GevGVCPExtendedStatusCodes**

Enables the generation of extended status codes.

Name	GevGVCPExtendedStatusCodes
Category	TansportLayerControl → GigEVision
Interface	IBoolean
Access	Read / Write
Unit	-
Values	true = 1 (On) false = 0 (Off)

7.16.2.11 GevGVCPExtendedStatusCodesSelector

Selects the GigE Vision version to control extended status codes for.

Name	GevGVCPExtendedStatusCodesSelector	
Category	TransportLayerControl → GigE Vision	
Interface	IEnumeration	
Access	Read / Write	
Unit	-	
Values	Version1_1	Version1_1.
	Version2_0	Version2_0.

7.16.2.12 GevGVCPPendingAck

Enables the generation of PENDING_ACK.

Name	GevGVCPPendingAck	
Category	TransportLayerControl → GigE Vision	
Interface	IBoolean	
Access	Read / Write	
Unit	-	
Values	true = 1 (On)	
	false = 0 (Off)	

7.16.2.13 GevIPConfigurationStatus

Reports the current IP configuration status.

Name	GevIPConfigurationStatus	
Category	TransportLayerControl → GigE Vision	
Interface	IEnumeration	
Access	Read only	
Unit	-	
Values	None	None.
	PersistentIP	Persistent IP.
	DHCP	DHCP.
	LLA	LLA.
	ForceIP	Force IP.

7.16.2.14 **GevInterfaceSelector**

Selects which logical link to control.

Name	GevInterfaceSelector
Category	TansportLayerControl → GigEVision
Interface	Integer
Access	Read / Write
Unit	-
Values	≥ 0

7.16.2.15 **GevMACAddress**

MAC address of the logical link.

Name	GevMACAddress
Category	TansportLayerControl → GigEVision
Interface	Integer
Access	Read only
Unit	-
Values	≥ 0

7.16.2.16 **GevMCDA**

Controls the destination IP address for the message channel.

Name	GevMCDA
Category	TansportLayerControl → GigEVision
Interface	Integer
Access	Read / Write
Unit	-
Values	≥ 0

7.16.2.17 **GevMCPHostPort**

Controls the port to which the device must send messages.

Name	GevMCPHostPort
Category	TansportLayerControl → GigEVision
Interface	Integer
Access	Read / Write
Unit	-
Values	≥ 0

7.16.2.18 GevMCRC

Controls the number of retransmissions allowed when a message channel message times out.

Name	GevMCRC
Category	TansportLayerControl → GigEVision
Interface	Integer
Access	Read / Write
Unit	-
Values	≥ 0

7.16.2.19 GevMCSP

This feature indicates the source port for the message channel.

Name	GevMCSP
Category	TansportLayerControl → GigEVision
Interface	Integer
Access	Read only
Unit	-
Values	≥ 0

7.16.2.20 GevMCTT

Provides the transmission timeout value in milliseconds.

Name	GevMCTT
Category	TansportLayerControl → GigEVision
Interface	Integer
Access	Read only
Unit	ms
Values	> 0

7.16.2.21 GevNumberOfInterfaces

Indicates the number of logical links supported by this device.

Name	GevNumberOfInterfaces
Category	TansportLayerControl → GigEVision
Interface	Integer
Access	Read only
Unit	-
Values	> 0

7.16.2.22 **GevPAUSEFrameReception**

Controls whether incoming PAUSE Frames are handled on the given logical link.

Name	GevPAUSEFrameReception
Category	TansportLayerControl → GigEVison
Interface	IBoolean
Access	Read only
Unit	-
Values	true = 1 (On) false = 0 (Off)

7.16.2.23 **GevPersistentDefaultGateway**

Controls the persistent default gateway for this logical link. It is only used when the device boots with the Persistent IP configuration scheme.

Name	GevPersistentDefaultGateway
Category	TansportLayerControl → GigEVison
Interface	Integer
Access	Read / Write
Unit	-
Values	≥ 0

7.16.2.24 **GevPersistentIPAddress**

Controls the Persistent IP address for this logical link. It is only used when the device boots with the Persistent IP configuration scheme.

Name	GevPersistentIPAddress
Category	TansportLayerControl → GigEVison
Interface	Integer
Access	Read / Write
Unit	-
Values	≥ 0

7.16.2.25 **GevPersistentSubnetMask**

Controls the Persistent subnet mask associated with the Persistent IP address on this logical link. It is only used when the device boots with the Persistent IP configuration scheme.

Name	GevPersistentSubnetMask
Category	TansportLayerControl → GigEVison
Interface	Integer
Access	Read / Write
Unit	-
Values	≥ 0

7.16.2.26 **GevPrimaryApplicationIPAddress**

Returns the address of the primary application.

Name	GevPrimaryApplicationIPAddress
Category	TansportLayerControl → GigEVision
Interface	lInteger
Access	Read only
Unit	-
Values	≥ 0

7.16.2.27 **GevPrimaryApplicationSocket**

Returns the UDP source port of the primary application.

Name	GevPrimaryApplicationSocket
Category	TansportLayerControl → GigEVision
Interface	lInteger
Access	Read only
Unit	-
Values	≥ 0

7.16.2.28 **GevPrimaryApplicationSwitchoverKey**

Controls the key to use to authenticate primary application switchover requests.

Name	GevPrimaryApplicationSwitchoverKey
Category	TansportLayerControl → GigEVision
Interface	lInteger
Access	Write only
Unit	-
Values	≥ 0

7.16.2.29 **GevSCDA**

Controls the destination IP address of the selected stream channel to which a GVSP transmitter must send data stream or the destination IP address from which a GVSP receiver may receive data stream.

Name	GevSCDA
Category	TansportLayerControl → GigEVision
Interface	lInteger
Access	Read / Write
Unit	-
Values	≥ 0

7.16.2.30 GevSCFTD

This feature indicates the delay (in timestamp counter unit) to insert between each block (image) for this stream channel.

Name	GevSCFTD
Category	TansportLayerControl → GigEVision
Interface	lInteger
Access	Read / Write
Unit	-
Values	0 ... 4294967295 (Increment: 1)

7.16.2.31 GevSCPD

Controls the delay (in timestamp counter unit) to insert between each packet for this stream channel. This can be used as a crude flow-control mechanism if the application or the network infrastructure cannot keep up with the packets coming from the device.

Name	GevSCPD
Category	TansportLayerControl → GigEVision
Interface	lInteger
Access	Read / Write
Unit	-
Values	0 ... 4294967295 (Increment: 1)

7.16.2.32 GevSCPHostPort

Controls the port of the selected channel to which a GVSP transmitter must send data stream or the port from which a GVSP receiver may receive data stream. Setting this value to 0 closes the stream channel.

Name	GevSCPHostPort
Category	TansportLayerControl → GigEVision
Interface	lInteger
Access	Read / Write
Unit	-
Values	0 ... 65535 (Increment: 1)

7.16.2.33 GevSCPIInterfaceIndex

Index of the logical link to use.

Name	GevSCPIInterfaceIndex
Category	TansportLayerControl → GigEVision
Interface	lInteger
Access	Read / Write
Unit	-
Values	0 ... 3 (Increment: 1)

7.16.2.34 GevSCPSDoNotFragment

The state of this feature is copied into the "do not fragment" bit of IP header of each stream packet. It can be used by the application to prevent IP fragmentation of packets on the stream channel.

Name	GevSCPSDoNotFragment
Category	TansportLayerControl → GigEVision
Interface	IBoolean
Access	Read / Write
Unit	-
Values	true = 1 (On) false = 0 (Off)

7.16.2.35 GevSCPSFireTestPacket

Sends a test packet. When this feature is set, the device will fire one test packet.

Name	GevSCPSFireTestPacket
Category	TansportLayerControl → GigEVision
Interface	IBoolean
Access	Read / Write
Unit	-
Values	true = 1 (On) false = 0 (Off)

7.16.2.36 GevSCSPPacketSize

Specifies the stream packet size, in bytes, to send on the selected channel for a GVSP transmitter or specifies the maximum packet size supported by a GVSP receiver.

Name	GevSCSPPacketSize
Category	TansportLayerControl → GigEVision
Interface	Integer
Access	Read / Write
Unit	Byte
Values	576 ... 16110 (Increment: 2)

7.16.2.37 GevSCSP

Indicates the source port of the stream channel.

Name	GevSCSP
Category	TansportLayerControl → GigEVision
Interface	Integer
Access	Read only
Unit	-
Values	≥ 0

7.16.2.38 **GevSecondURL**

Indicates the second URL to the GenICam XML device description file. This URL is an alternative if the application was unsuccessful to retrieve the device description file using the first URL.

Name	GevSecondURL
Category	TansportLayerControl → GigEVision
Interface	IString
Access	Read only
Unit	-
Values	URL

7.16.2.39 **GevStreamChannelSelector**

Selects the stream channel to control.

Name	GevStreamChannelSelector
Category	TansportLayerControl → GigEVision
Interface	Integer
Access	Read / Write
Unit	-
Values	≥ 0

7.16.2.40 **GevSupportedOption**

Returns if the selected GEV option is supported.

Name	GevSupportedOption
Category	TansportLayerControl → GigEVision
Interface	IBoolean
Access	Read only
Unit	-
Values	true = 1 (On) false = 0 (Off)

7.16.2.41 GevSupportedOptionSelector

Selects the GEV option to interrogate for existing support.

Name	GevSupportedOptionSelector
Category	TansportLayerControl → GigEVison
Interface	IEnumeration
Access	Read / Write
Unit	-
Values	see table below

Action	PacketResend
CCPApplicationSocket	PendingAck
CommandsConcatenation	PrimaryApplicationSwitchover
DiscoveryAckDelay	ScheduledAction
DiscoveryAckDelayWritable	SerialNumber
DynamicLAG	SingleLink
Event	StandardIDMode
EventData	StaticLAG
ExtendedStatusCodes	StreamChannel0AllInTransmission
ExtendedStatusCodesVersion2_0	StreamChannel0BigAndLittleEndian
HeartbeatDisable	StreamChannel0ExtendedChunkData
IEEE1588	StreamChannel0IPReassembly
IPConfigurationDHCP	StreamChannel0MultiZone
IPConfigurationLLA	StreamChannel0PacketResendDestination
IPConfigurationPersistentIP	StreamChannel0UnconditionalStreaming
LinkSpeed	StreamChannelSourceSocket
ManifestTable	TestData
MessageChannelSourceSocket	UnconditionalAction
MultiLink	UserDefinedName
PAUSEFrameGeneration	WriteMem
PAUSEFrameReception	

7.16.2.42 InterfaceSpeedMode

Show the interface speed mode as string.

Name	InterfaceSpeedMode	
Category	TansportLayerControl → GigEVision	
Interface	IEnumeration	
Access	Read only	
Unit	-	
Values	Ethernet100Mbps	Operation at 100 Mbps.
	Ethernet10Gbps	Operation at 10 Gbps.
	Ethernet1Gbps	Operation at 1 Gbps.
	Ethernet2_5Gbps	Operation at 2.5 Gbps.
	Ethernet5Gbps	Operation at 5 Gbps.

7.16.3 PayloadSize

Provides the number of bytes transferred for each image or chunk on the stream channel at the current settings. This includes any end-of-line, end-of-frame statistics or other stamp data. This is the total size of data payload for a data block.

Name	PayloadSize	
Category	TansportLayerControl	
Interface	IInteger	
Access	Read only	
Unit	Byte	
Values	0 ... depends on current settings (Increment: 1)	

7.16.4 Category: Category: TransportLayerControl → PtpControl (.PTP only)

Category that contains the features related to the Precision Time Protocol (PTP) of the device.

General Information

IEEE 1588 Precision Time Protocol (PTP) manages clock synchronization of multiple devices across an Ethernet network. On a local area network, it achieves clock accuracy in the sub-microsecond range, making it suitable for measurement and control systems.

PTP was designed to improve on existing clock synchronization methods such as Network Time Protocol (NTP) and Global Positioning System (GPS). NTP suffers from poor accuracy, often quoted to be several milliseconds using a fast Ethernet network. GPS provides nanosecond precision using atomic clock and satellite triangulation; however, it is an expensive component to incorporate into a camera.

PTP provides microsecond precision without increasing component cost, providing better accuracy than NTP at a lower cost than GPS.

The diagram below shows the steps taken to synchronize the slave clock to that of the master.

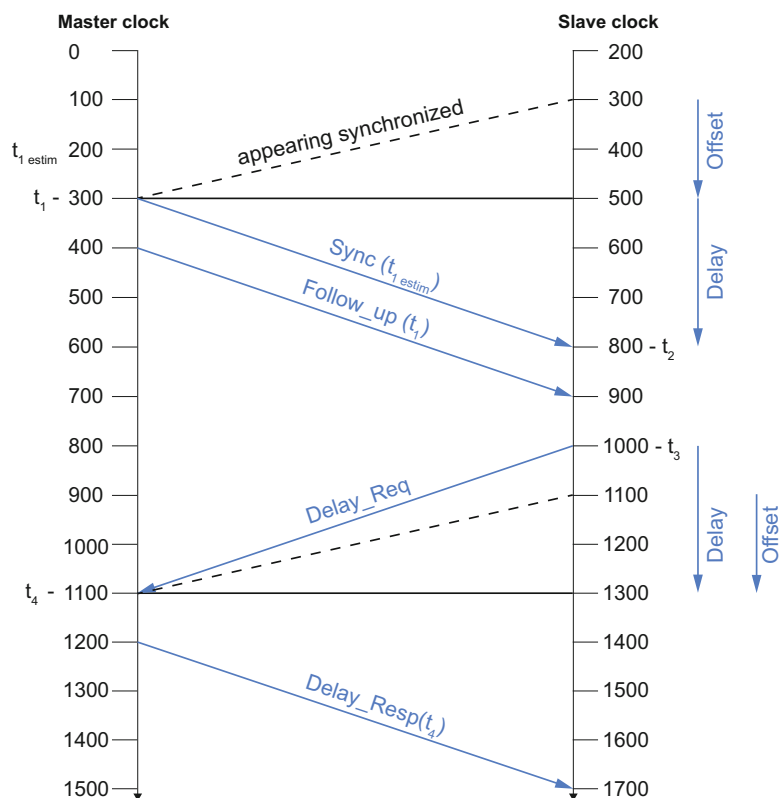

PTP synchronization

Synchronization begins when the device configured as the Master PTP clock transmits a *Sync* telegram using multicast messaging. Devices configured as Slave PTP clocks calculate the time difference between their clock and the Master PTP clock, and adjust accordingly.

Slave clock frequencies are constantly adjusted, through follow up and delay messages, to keep their clock value as close as possible to the master clock. While all Slave clocks are within 1 μ s of the master, PTP sync is achieved.

Network Topology without GPS Clock

Achieving PTP synchronization between multiple cameras requires all cameras to be on the same network/subnet. The IEEE 1588 best master clock algorithm will select a camera as the master clock. Each camera will synchronize to this master clock.

This restriction is due to the current inability of any network card hardware to forward PTP sync multicast packets between ports within the 1 μ s requirement.

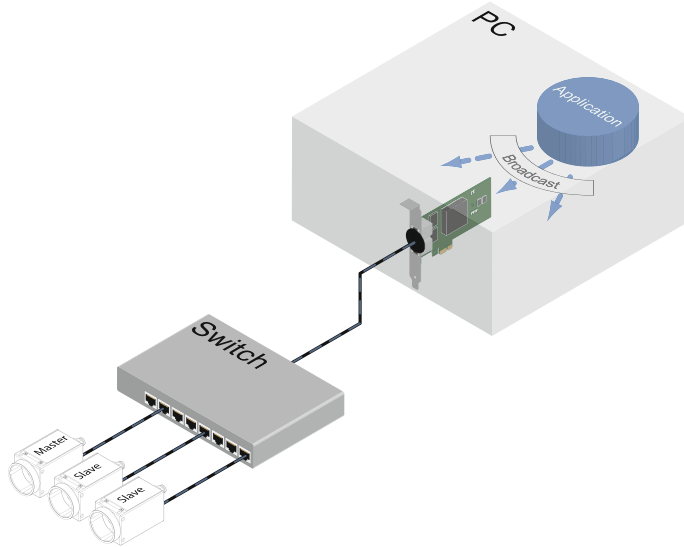

Network Topology with GPS Clock

The cameras can be synchronized to a GPS timer, allowing “real world time” synchronization. Configure *PtpMode* on all of the cameras to *Slave* or *Auto*. In *Auto*, the IEEE 1588 best master clock algorithm will elect the GPS clock as the master. Each camera will synchronize to the GPS master clock.

Notice

To ensure a reliable synchronization, the GPS master clock must be configured with a Sync interval between 0.5 s and 2 s (according to the Default PTP profile for use with the delay request-response mechanism).

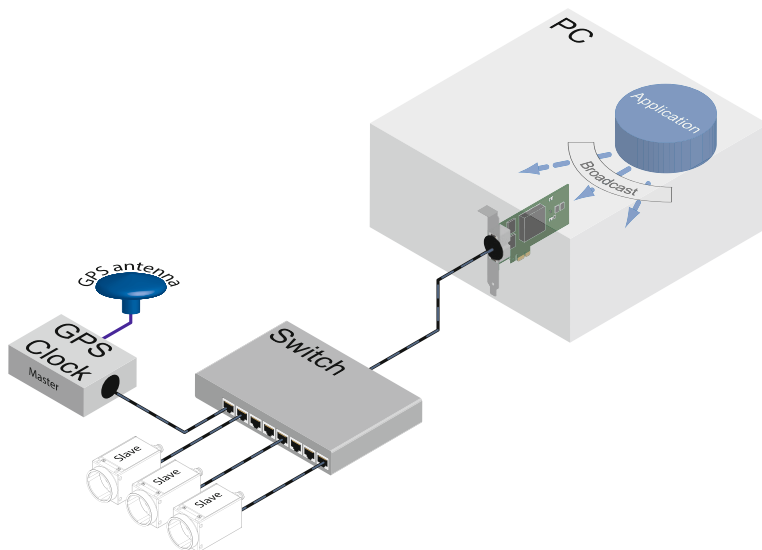

7.16.4.1 PtpClockAccuracy

Indicates the expected accuracy of the device PTP clock when it is the grandmaster, or in the event it becomes the grandmaster.

Name	PtpClockAccuracy
Category	TansportLayerControl → PtpControl
Interface	IEnumeration
Access	Read only
Unit	-
Values	Within1us Within2p5u

7.16.4.2 PtpClockID

Returns the latched clock ID of the PTP device. PTP Parent Clock ID.

Notice

Byte 0 of the IEEE ClockIdentity field is mapped to the MSB.

Name	PtpClockID
Category	TansportLayerControl → PtpControl
Interface	IInteger
Access	Read only
Unit	MacAdress
Values	80-00-00-00-00-00 ... 7F-FF-FF-FF-FF-FF-FF (Increment: 1)

7.16.4.3 PtpDataSetLatch

Latches the current values from the device's PTP clock data set.

Name	PtpDataSetLatch
Category	TansportLayerControl → PtpControl
Interface	ICommand
Access	Write only
Unit	-
Values	-

7.16.4.4 PtpEnable

Enables the Precision Time Protocol (PTP).

Notice

To write this feature, set `TLParamsLocked = 0`.

Name	PtpEnableEnable
Category	TansportLayerControl → PtpControl
Interface	IBoolean
Access	Read/Write
Unit	-
Values	true = 1 (On)
	false = 0 (Off)

7.16.4.5 PtpGrandmasterClockID

Returns the latched grandmaster clock ID of the PTP device. The grandmaster clock ID is the clock ID of the current grandmaster clock.

Notice

Byte 0 of the IEEE ClockIdentity field is mapped to the MSB.

Name	PtpGrandmasterClockID
Category	TansportLayerControl → PtpControl
Interface	Integer
Access	Read only
Unit	MacAdress
Values	80-00-00-00-00-00 ... 7F-FF-FF-FF-FF-FF-FF (Increment: 1)

7.16.4.6 PtpMode

Selects the PTP clock type the device will act as.

Name	PtpMode	
Category	TansportLayerControl → PtpControl	
Interface	IEnumeration	
Access	Read/Write	
Unit	-	
Values	Auto	The device uses the IEEE 1588 best master clock algorithm to determine which device is master, and which devices are slaves. In case the device is not the best master, it will act as a PTP slave.
	Slave	The device's clock will act as a PTP slave only to align with a master device's clock.

7.16.4.7 PtpOffsetFromMaster

Returns the latched offset from the PTP master clock in nanoseconds.

Name	PtpOffsetFromMaster
Category	TransportLayerControl → PtpControl
Interface	Integer
Access	Read only
Unit	ns
Values	-9223372036854775808 ... 9223372036854775808 (Increment: 1)

7.16.4.8 PtpParentClockID

Returns the latched parent clock ID of the PTP device. The parent clock ID is the clock ID of the current master clock.

Notice

Byte 0 of the IEEE ClockIdentity field is mapped to the MSB.

Name	PtpParentClockID
Category	TransportLayerControl → PtpControl
Interface	Integer
Access	Read only
Unit	MacAddress
Values	80-00-00-00-00-00 ... 7F-FF-FF-FF-FF-FF-FF (Increment: 1)

7.16.4.9 PtpServoStatus

Notice

PTPServoStatus may change temporarily when changing the IP address.

Returns the latched state of the clock servo.

When the servo is in a locked state, the value returned is 'Locked'. When the servo is in a non-locked state, a device-specific value can be returned to give specific information. If no device-specific value is available to describe the current state of the clock servo, the value should be 'Unknown'.

Name	PtpServoStatus
Category	TransportLayerControl → PtpControl
Interface	Enumeration
Access	Read only
Unit	-
Values	Unknown Locked

7.16.4.10 PtpStatus

Returns the latched state of the PTP clock.

Name	PtpStatus	
Category	TansportLayerControl → PtpControl	
Interface	IEnumeration	
Access	Read only	
Unit	-	
Values	Disabled	PTP is disabled.
	Faulty	The fault state of the protocol.
	Initializing	PTP is being initialized.
	Listening	Device is listening for other PTP enabled devices.
	Master	Device acting as master clock.
	Passive	If there are 2 or more devices with PtpMode = Master, this device has an inferior clock and is not synchronized to the master.
	Pre_Master	The port shall behave in all respects as though it were in the MASTER state except that it shall not place any messages on its communication path except for Pdelay_Req, Pdelay_Resp, Pdelay_Resp_Follow_Up, signaling, or management messages.
	Slave	PTP synchronization between this device and master is achieved.
Uncalibrated	PTP synchronization not yet achieved.	

7.16.5 Category: TransportLayerControl → USB3Vision

Category that contains the features pertaining to the USB3 Vision transport layer of the device.

7.16.5.1 InterfaceSpeedMode

Show the interface speed mode as string.

Name	InterfaceSpeedMode	
Category	TansportLayerControl → USB3Vision	
Interface	IEnumeration	
Access	Read only	
Unit	-	
Values	FullSpeed	USB operation at 12 Mbps.
	HighSpeed	USB operation at 480 Mbps.
	LowSpeed	USB operation at 1.5 Mbps.
	SuperSpeed	USB operation at 5 Gbps.

7.16.5.2 SIControl

Controls streaming operation.

Name	SIControl	
Category	TansportLayerControl → USB3Vision	
Interface	IEnumeration	
Access	Read only	
Unit	-	
Values	StreamDisabled	Disable Streaming.
	StreamEnabled	Enable Streaming.

7.16.5.3 SIPayloadFinalTransfer1Size

Size of first final Payload Transfer.

Name	SIPayloadFinalTransfer1Size	
Category	TansportLayerControl → USB3Vision	
Interface	IInteger	
Access	Read only	
Unit	Byte	
Values	0 - 4294967295 (Increment: 1)	

7.16.5.4 SIPayloadFinalTransfer2Size

Size of second final Payload Transfer.

Name	SIPayloadFinalTransfer2Size	
Category	TansportLayerControl → USB3Vision	
Interface	IInteger	
Access	Read only	
Unit	Byte	
Values	0 - 4294967295 (Increment: 1)	

7.16.5.5 SIPayloadTransferCount

Expected number of Payload Transfers.

Name	SIPayloadTransferCount	
Category	TansportLayerControl → USB3Vision	
Interface	IInteger	
Access	Read only	
Unit	-	
Values	0 - 4294967295 (Increment: 1)	

7.16.5.6 SIPayloadTransferSize

Expected size of a single Payload Transfer.

Name	SIPayloadTransferSize
Category	TransportLayerControl → USB3Vision
Interface	Integer
Access	Read only
Unit	Byte
Values	0 - 4294967295 (Increment: 1)

7.17 Category: UserSetControl

Category that contains the User Set control features. It allows loading or saving factory or user-defined settings.

Loading the factory default User Set guarantees a state where a continuous acquisition can be started using only the mandatory features.

These user sets are stored within the camera and can be loaded, saved and transferred to other cameras.

By using *User Set Default* one of these four user sets can be set as the default, which means that the camera starts up with these adjusted parameters.

7.17.1 UserSetDefault

Four user sets are available for this camera. *User Set 1*, *User Set 2*, *User Set 3* are user-specific and can contain user-definable parameters.

Selects the feature *UserSet* to load and make active by default when the device is reset. The factory settings are stored in the user set *Default*. This is the only user set that cannot be edited.

Notice

All saved user sets can be set as default.

Name	UserSetDefault
Category	UserSetControl
Interface	IEnumeration
Access	Read / Write
Unit	-
Values	Default Select the factory setting user set.
	User Set 1 Select the User Set 1 (available when saved).
	User Set 2 Select the User Set 2 (available when saved).
	User Set 3 Select the User Set 3 (available when saved).

7.17.2 UserSetFeatureEnable

Enables the selected feature and make it active in all the UserSets.

Name	UserSetFeatureEnable
Category	UserSetControl
Interface	IBoolean
Access	Read only
Unit	-
Values	true = 1 (On) false = 0 (Off)

7.17.3 UserSetFeatureSelector

Selects which individual UserSet feature to control.

Name	UserSetFeatureSelector
Category	UserSetControl
Interface	IEnumeration
Access	Read / Write
Unit	-
Values	see tables below

Notice

Compatibility Gain

A *Gain* saved with Release 2 cameras in the UserSet is not compatible with Release 3 cameras.

Parameter		
AcquisitionFrameCount	DefectPixelCorrection	PixelFormat
AcquisitionFrameRate	DeviceTemperature-StatusTransition	ReadoutMode
AcquisitionFrameRate-Enable	EventNotification	ReverseX
AcquisitionMode	ExposureMode	ReverseY
ActionDeviceKey	ExposureTime	SensorShutterMode (≥ Rel. 3)
ActionGroupKey	FixedPatternNoiseCorrection	SequencerSetNext (≥ Rel. 2)
ActionGroupMask	FrameCounter	SequencerSetStart (≥ Rel. 2)
AutoFeatureHeight (≥ Rel. 3)	Gain	SequencerTrigger-Activation (≥ Rel. 2)
AutoFeatureOffsetX (≥ Rel. 3)	GainAuto (≥ Rel. 3)	SequencerTrigger-Source (≥ Rel. 2)
AutoFeatureOffsetY (≥ Rel. 3)	GainAutoMaxValue (≥ Rel. 3)	TestPattern
AutoFeatureWidth (≥ Rel. 3)	GainAutoMinValue (≥ Rel. 3)	TimerDelay
BalanceWhiteAuto	Gamma	TimerDuration
BinningHorizontal	GevSCFTD	TimerTriggerActivation
BinningHorizontalMode	GevSCPD	TimerTriggerSource
BinningVertical	Height	TriggerActivation
BinningVerticalMode	LUTContent	TriggerDelay
BlackLevel	LUTEnable	TriggerMode
BrightnessAutoNominalValue	LUTValue	TriggerSource
BrightnessAutoPriority	LineDebouncerHighTimeAbs	UserOutputValue
ChunkEnable	LineDebouncerLowTimeAbs	UserOutputValueAll
ChunkModeActive	LineInverter	Width
ColorTransformation-Value	LineMode (≥ Rel. 3)	
CounterDuration	LinePWMDuration (VCXG.I / .XT only)	
CounterEventActivation	LinePWMMaxDuration (VCXG.I / .XT only)	
CounterEventSource	LinePWMMode (VCXG.I / .XT only)	
DeviceLinkThroughput-Limit	LineSource	
CounterResetActivation	OffsetX	
CounterResetSource	OffsetY	

VCXU / .XC

Parameter		
AcquisitionFrameCount	ExposureAuto	ReverseY
AcquisitionFrameRate	ExposureAutoMaxValue	SensorShutterMode (≥ Rel. 3)
AcquisitionFrameRate- Enable	ExposureAutoMinValue	SequencerSetNext (≥ Rel. 2)
AcquisitionMode	ExposureMode	SequencerSetStart (≥ Rel. 2)
AutoFeatureHeight (≥ Rel. 3)	ExposureTime	SequencerTrigger- Activation (≥ Rel. 2)
AutoFeatureOffsetX (≥ Rel. 3)	FixedPatternNoise- Correction	SequencerTrigger- Source (≥ Rel. 2)
AutoFeatureOffsetY (≥ Rel. 3)	FrameCounter	TestPattern
AutoFeatureWidth (≥ Rel. 3)	Gain	TimerDelay
BinningHorizontal	GainAuto (≥ Rel. 3)	TimerDuration
BinningHorizontalMode	GainAutoMaxValue (≥ Rel. 3)	TimerTriggerActivation
BinningVertical	GainAutoMinValue (≥ Rel. 3)	TimerTriggerSource
BinningVerticalMode	Gamma	TriggerActivation
BlackLevel	Height	TriggerDelay
BrightnessAutoNominal- Value	LUTContent	TriggerMode
BrightnessAutoPriority	LUTEnable	TriggerSource
ChunkEnable	LUTValue	UserOutputValue
ChunkModeActive		UserOutputValueAll
ColorTransformationAuto	LineDebouncerHigh-Time- Abs	Width
CounterDuration	LineDebouncerLow- TimeAbs	
CounterEventActivation	LineInverter	
CounterEventSource	LineMode (≥ Rel. 3)	
CounterResetActivation	LineSource	
CounterResetSource	OffsetX	
DefectPixelCorrection	OffsetY	
DeviceLinkThroughputLimit	PixelFormat	
DeviceTemperatureStatus- Transition	ReadoutMode	
EventNotification	ReverseX	

7.17.4 UserSetLoad

Loads the *UserSet* specified by *UserSetSelector* to the device and makes it active.

Notice

Loading a *UserSet* requires the stop of the camera.

Name	UserSetLoad
Category	UserSetControl
Interface	ICommand
Access	Write only
Unit	-
Values	-

7.17.5 UserSetSave

Save the User Set specified by *UserSetSelector* to the non-volatile memory of the device.

Notice

The factory settings are stored in the user set *Default*. This is the only user set that cannot be edited. Select at *UserSetSelector* *UserSet1*, *UserSet2* or *UserSet3*.

Name	UserSetSave
Category	UserSetControl
Interface	ICommand
Access	Write only
Unit	-
Values	-

7.17.6 UserSetSelector

Selects the Feature User Set to load, save or configure. The factory settings are stored in the user set *Default*. This is the only user set that cannot be edited.

Name	UserSetSelector	
Category	UserSetControl	
Interface	IEnumeration	
Access	Read / Write	
Unit	-	
Values	Default	Select the factory setting user set.
	User Set 1	Select the User Set 1.
	User Set 2	Select the User Set 2.
	User Set 3	Select the User Set 3.

7.18 Category: boCalibrationData

Category for functions of calibration data.

Notice

Calibration setting

Calibration is not in the camera and either via Camera Explorer. Enter here the category parameters to be determined in the application environment by external software (e.g. OpenCV). This calibration data is saved non-volatile to the camera.

For calibration, the camera provides image together with stored calibration data. Calibration must be performed using external software.

7.18.1 boCalibrationAngularAperture

Angular lens aperture as the angular lens size as seen from the focal point in degrees.

Name	boCalibrationAngularAperture
Category	boCalibrationData
Interface	IFloat
Access	Read / Write
Unit	°
Values	0.000000 ... 360.000000 (Increment: 1.00)

7.18.2 boCalibrationDataConfigurationMode

Controls whether boCalibrationDataConfigurationMode is active.

Name	boCalibrationDataConfigurationMode
Category	boCalibrationData
Interface	IEnumeration
Access	Read / Write
Unit	-
Values	Off Disables <i>boCalibrationDataConfigurationMode</i> .
	On Enables <i>boCalibrationDataConfigurationMode</i> .

7.18.3 boCalibrationDataSave

Save the current calibration data to the non-volatile device memory.

Name	boCalibrationDataSave
Category	boCalibrationData
Interface	ICommand
Access	Write only
Unit	-
Values	-

7.18.4 boCalibrationDataVersion

Version of the optical controller.

Name	boCalibrationDataVersion
Category	boCalibrationData
Interface	IString
Access	Read only
Unit	-
Values	-

7.18.5 boCalibrationFocalLength

Focal length in millimeters (mm).

Name	boCalibrationFocalLength
Category	boCalibrationData
Interface	IFloat
Access	Read / Write
Unit	mm
Values	0.000000 ... 4,294,967,296.000000 (Increment: 1.00)

7.18.6 boCalibrationMatrixSelector

Selection of the calibration matrix.

Name	boCalibrationMatrixSelector	
Category	boCalibrationData	
Interface	IEnumeration	
Access	Read / Write	
Unit	-	
Values	Camera Matrix	Selection of the camera matrix.
	New Camera Matrix	Selection of the camera matrix considering the geometric distortion.

7.18.7 boCalibrationMatrixValue

Selected value of the calibration matrix.

Name	boCalibrationMatrixValue
Category	boCalibrationData
Interface	IFloat
Access	Read only
Unit	°
Values	-3.40282e+38 ... 3.40282e+38 (Increment: 1.00)

7.18.8 boCalibrationMatrixValueSelector

Value selector of the calibration matrix.

Name	boCalibrationMatrixValueSelector	
Category	boCalibrationData	
Interface	IEnumeration	
Access	Read / Write	
Unit	-	
Values	Value 11	Selects the matrix value in row 1 column 1.
	Value 12	Selects the matrix value in row 1 column 2.
	Value 13	Selects the matrix value in row 1 column 3.
	Value 21	Selects the matrix value in row 2 column 1.
	Value 22	Selects the matrix value in row 2 column 2.
	Value 23	Selects the matrix value in row 2 column 3.
	Value 31	Selects the matrix value in row 3 column 1.
	Value 32	Selects the matrix value in row 3 column 2.
	Value 33	Selects the matrix value in row 3 column 3.

7.18.9 boCalibrationVectorSelector

Selects the calibration vector.

Name	boCalibrationVectorSelector	
Category	boCalibrationData	
Interface	IEnumeration	
Access	Read / Write	
Unit	-	
Values	rvec	Selects the output rotation vector.
	tvec	Selects the translation vector.

7.18.10 boCalibrationVectorValue

Value of the selected calibration vector.

Name	boCalibrationVectorValue	
Category	boCalibrationData	
Interface	IFloat	
Access	Read only	
Unit	°	
Values	-3.40282e+38 ... 3.40282e+38 (Increment: 1.00)	

7.18.11 boCalibrationVectorValueSelector

Selects value selector for calibration vector.

Name	boCalibrationVectorValueSelector	
Category	boCalibrationData	
Interface	IEnumeration	
Access	Read / Write	
Unit	-	
Values	Value 1	Selects vector value 1.
	Value 2	Selects vector value 2.
	Value 3	Selects vector value 3.

7.18.12 boGeometryDistortionValue

Selected geometric distortion value.

Name	boGeometryDistortionValue	
Category	boCalibrationData	
Interface	IFloat	
Access	Read only	
Unit	-	
Values	-3.40282e+38 ... 3.40282e+38 (Increment: 1.00)	

7.18.13 boGeometryDistortionValueSelector

Selector for geometric distortion.

Name	boCalibrationVectorSelector	
Category	boCalibrationData	
Interface	IEnumeration	
Access	Read / Write	
Unit	-	
Values	k1	Selects geometric distortion value k1.
	k2	Selects geometric distortion value k2.
	k3	Selects geometric distortion value k3.
	p1	Selects geometric distortion value p1.
	p2	Selects geometric distortion value p2.

8. VCXG /.XC/.I/.I.XT/.PTP /.I.PTP – Interface Functionalities

8.1 Device Information

This Gigabit Ethernet-specific information on the device is part of the Discovery-Acknowledge of the camera.

Included information:

- MAC address
- Current IP configuration (persistent IP / DHCP / LLA)
- Current IP parameters (IP address, subnet mask, gateway)
- Manufacturer's name
- Manufacturer-specific information
- Device version
- Serial number
- User-defined name (user programmable string)

8.2 Packet Size and Maximum Transmission Unit (MTU)

Network packets can be of different sizes. The size depends on the network components employed. When using GigE Vision® compliant devices, it is generally recommended to use larger packets. On the one hand the overhead per packet is smaller, on the other hand larger packets cause less CPU load.

The packet size of UDP packets can differ from 576 Bytes up to the MTU.

The MTU describes the maximal packet size which can be handled by all network components involved.

In principle modern network hardware supports a packet size of 1500 Byte, which is specified in the GigE network standard. "Jumboframes" merely characterizes a packet size exceeding 1500 Bytes.

Baumer VCXG cameras can handle a MTU of up to 16384 Bytes.

8.3 Inter Packet Gap (IPG)

To achieve optimal results in image transfer, several Ethernet-specific factors need to be considered.

Upon starting the image transfer of a camera, the data packets are transferred at maximum transfer speed (1 Gbit/sec). In accordance with the network standard, Baumer employs a minimal separation of 12 Bytes between two packets. This separation is called "inter packet gap" (IPG). In addition to the minimal IPG, the GigE Vision® standard stipulates that the IPG be scalable (user-defined).

IPG:

The IPG is measured in ticks.

An easy rule of thumb is:

1 Tick is equivalent to 1 Bit of data.

You should also not forget to add the various ethernet headers to your calculation.

Notice

According to the Ethernet standard, IPG_{min} can not be lower than 12 Bytes.

8.3.1 Example 1: Multi Camera Operation – Minimal IPG

Setting the IPG to minimum means every image is transferred at maximum speed. Even by using a frame rate of 1 fps this results in full load on the network. Such "bursts" can lead to an overload of several network components and a loss of packets. This can occur, especially when using several cameras.

In the case of two cameras sending images at the same time, this would theoretically occur at a transfer rate of 2 Gbits/sec. The switch has to buffer this data and transfer it at a speed of 1 Gbit/sec afterwards. Depending on the internal buffer of the switch, this operates without any problems up to n cameras ($n \geq 1$). More cameras would lead to a loss of packets. These lost packets can however be saved by employing an appropriate resend mechanism, but this leads to additional load on the network components.

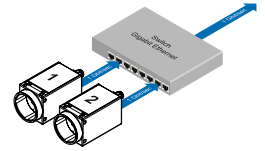

Operation of two cameras employing a Gigabit Ethernet switch. Data processing within the switch is displayed in the next two figures.

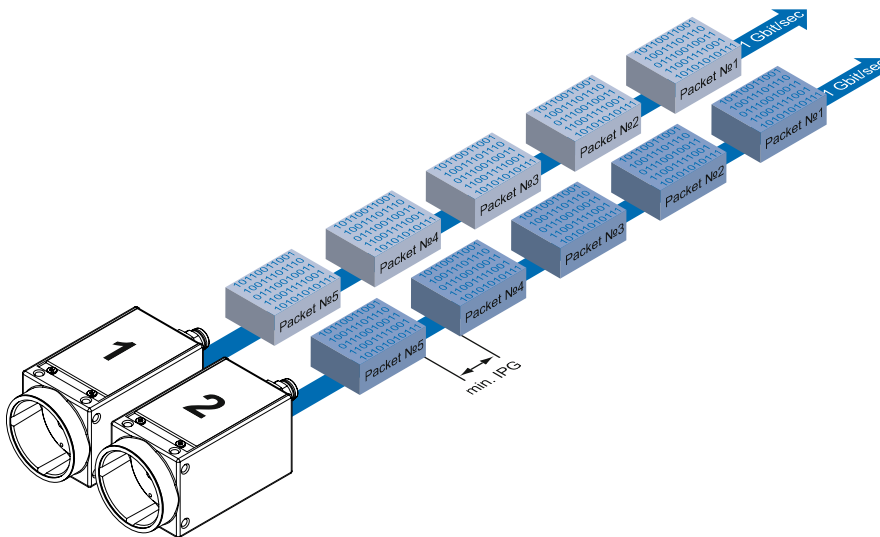

Operation of two cameras employing a minimal inter packet gap (IPG).

8.3.2 Example 2: Multi Camera Operation – Optimal IPG

A better method is to increase the IPG to a size of

$$\text{optimal IPG} = (\text{number of cameras} - 1) * \text{packet size} + 2 \times \text{minimal IPG}$$

In this way both data packets can be transferred successively (zipper principle), and the switch does not need to buffer the packets.

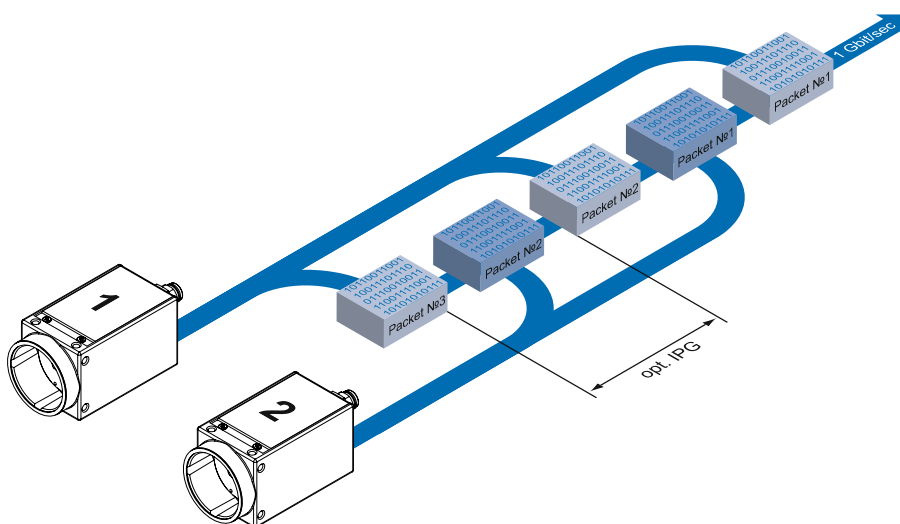

Max. IPG:
On the Gigabit Ethernet the max. IPG and the data packet must not exceed 1 Gbit. Otherwise data packets can be lost.

Operation of two cameras employing an optimal inter packet gap (IPG).

8.4 Transmission Delay

Another approach for packet sorting in multi-camera operation is the so-called Transmission Delay.

Due to the fact, that the currently recorded image is stored within the camera and its transmission starts with a predefined delay, complete images can be transmitted to the PC at once.

The following figure should serve as an example:

Principle of the transmission delay.

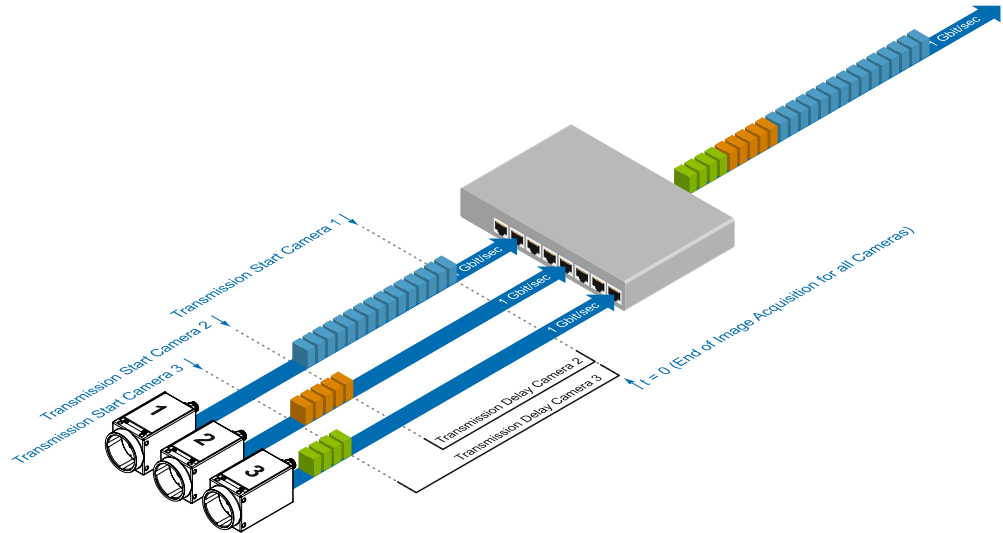

For the image processing three cameras are employed – for example camera 1: VCXG-53M, camera 2: VCXG-13M, camera 3: VCXG-23M.

Due to process-related circumstances, the image acquisitions of all cameras end at the same time. Now the cameras are not trying to transmit their images simultaneously, but – according to the specified transmission delays – subsequently. Thereby the first camera starts the transmission immediately – with a transmission delay "0".

8.4.1 Time Saving in Multi-Camera Operation

As previously stated, the transmission delay feature was especially designed for multi-camera operation with employment of different camera models. Just here a significant acceleration of the image transmission can be achieved:

Comparison of transmission delay and inter packet gap, employed for a multi-camera system with different camera models.

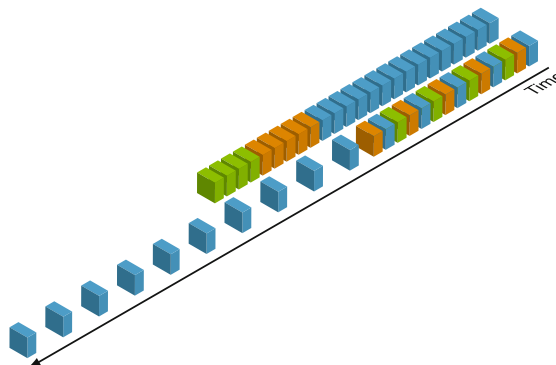

For the above mentioned example, the employment of the transmission delay feature results in a time saving – compared to the approach of using the inter packet gap – of approx. 45% (applied to the transmission of all three images).

8.4.2 Configuration Example

For the three employed cameras the following data are known:

Camera Model	Sensor Resolution [pixel]	Pixel Format (Pixel Depth) [bit]	Resulting Data Volume [bit]	Readout Time [msec]	Exposure Time [msec]	Transfer Time (GigE) [msec]
VCXG-53M	2592 x 2048	8	42467328	35.3	20	≈ 42.47
VCXG-13M	1280 x 1024	8	10485760	6.74	20	≈ 10.48
VCXG-23M	1920 x 1200	8	18432000	12.2	20	≈ 18.43

- The sensor resolution and the readout time ($t_{readout}$) can be found in the respective Technical Data Sheet (TDS). For the example a full frame resolution is used.
- The exposure time ($t_{exposure}$) is manually set to 20 msec.
- The resulting data volume is calculated as follows:

$$Resulting\ Data\ Volume = horizontal\ Pixels \times vertical\ Pixels \times Pixel\ Depth$$
- The transfer time ($t_{transferGigE}$) for full GigE transfer rate is calculated as follows:

$$Transfer\ Time\ (GigE) = Resulting\ Data\ Volume / 1000^3 \times 1000\ [msec]$$

All the cameras are triggered simultaneously.

The transmission delay is realized as a counter, that is started immediately after the sensor readout is started.

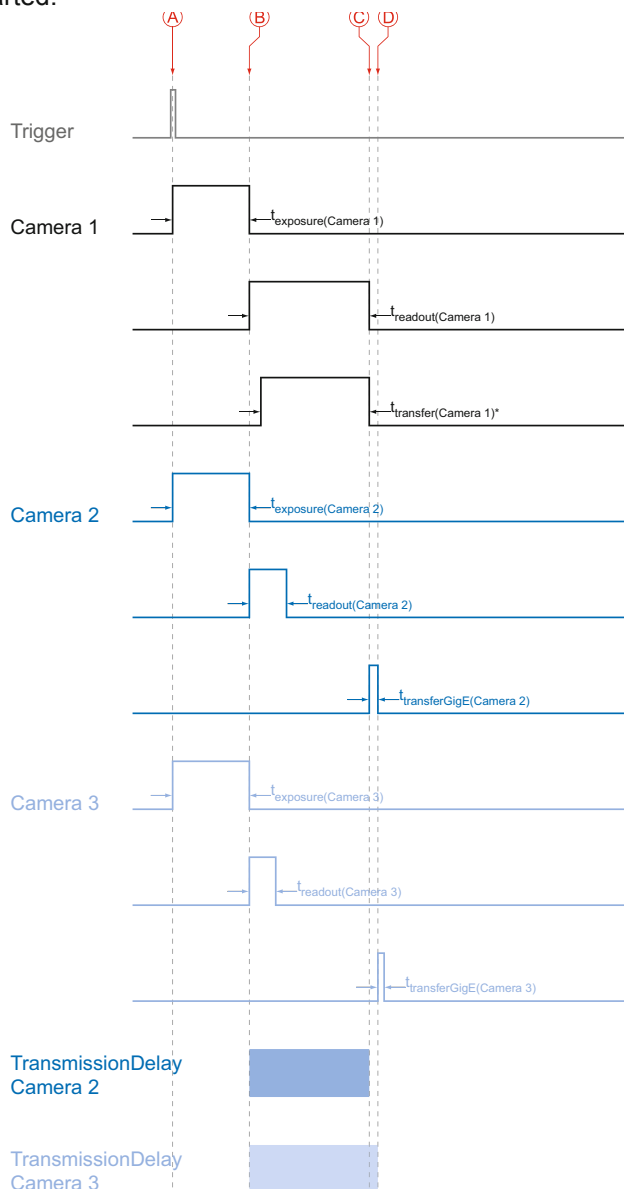

Timings:
A - exposure start for all cameras
B - all cameras ready for transmission
C - transmission start camera 2
D - transmission start camera 3

* Due to technical issues the data transfer of camera 1 does not take place with full GigE speed.

Timing diagram for the transmission delay of the three employed cameras, using even exposure times.

In general, the transmission delay is calculated as:

$$t_{\text{TransmissionDelay}(\text{Camera } n)} = t_{\text{exposure}(\text{Camera } 1)} + t_{\text{readout}(\text{Camera } 1)} - t_{\text{exposure}(\text{Camera } n)} + \sum_{n \geq 3}^n t_{\text{transferGigE}(\text{Camera } n-1)}$$

Therewith for the example, the transmission delays of camera 2 and 3 are calculated as follows:

$$t_{\text{TransmissionDelay}(\text{Camera } 2)} = t_{\text{exposure}(\text{Camera } 1)} + t_{\text{readout}(\text{Camera } 1)} - t_{\text{exposure}(\text{Camera } 2)}$$

$$t_{\text{TransmissionDelay}(\text{Camera } 3)} = t_{\text{exposure}(\text{Camera } 1)} + t_{\text{readout}(\text{Camera } 1)} - t_{\text{exposure}(\text{Camera } 3)} + t_{\text{transferGigE}(\text{Camera } 2)}$$

Solving this equations leads to:

$$\begin{aligned} t_{\text{TransmissionDelay}(\text{Camera } 2)} &= 20 \text{ msec} + 35.3 \text{ msec} - 20 \text{ msec} \\ &= 35.3 \text{ msec} \\ &= 35300000 \text{ ticks} \end{aligned}$$

$$\begin{aligned} t_{\text{TransmissionDelay}(\text{Camera } 3)} &= 20 \text{ msec} + 35.3 \text{ msec} - 20 \text{ msec} + 10.48 \text{ msec} \\ &= 45.78 \text{ msec} \\ &= 45780000 \text{ ticks} \end{aligned}$$

Notice

In Baumer GAPI the delay is specified in ticks. How do convert microseconds into ticks?

$$1 \text{ tick} = 1 \text{ ns}$$

$$1 \text{ msec} = 1000000 \text{ ns}$$

$$1 \text{ tick} = 0,000001 \text{ msec}$$

$$\text{ticks} = t_{\text{TransmissionDelay}} [\text{msec}] / 0.000001 = t_{\text{TransmissionDelay}} [\text{ticks}]$$

8.5 Multicast

Multicasting offers the possibility to send data packets to more than one destination address – without multiplying bandwidth between camera and Multicast device (e.g. Router or Switch).

The data is sent out to an intelligent network node, an IGMP (Internet Group Management Protocol) capable Switch or Router and distributed to the receiver group with the specific address range.

In the example on the figure below, multicast is used to process image and message data separately on two different PC's.

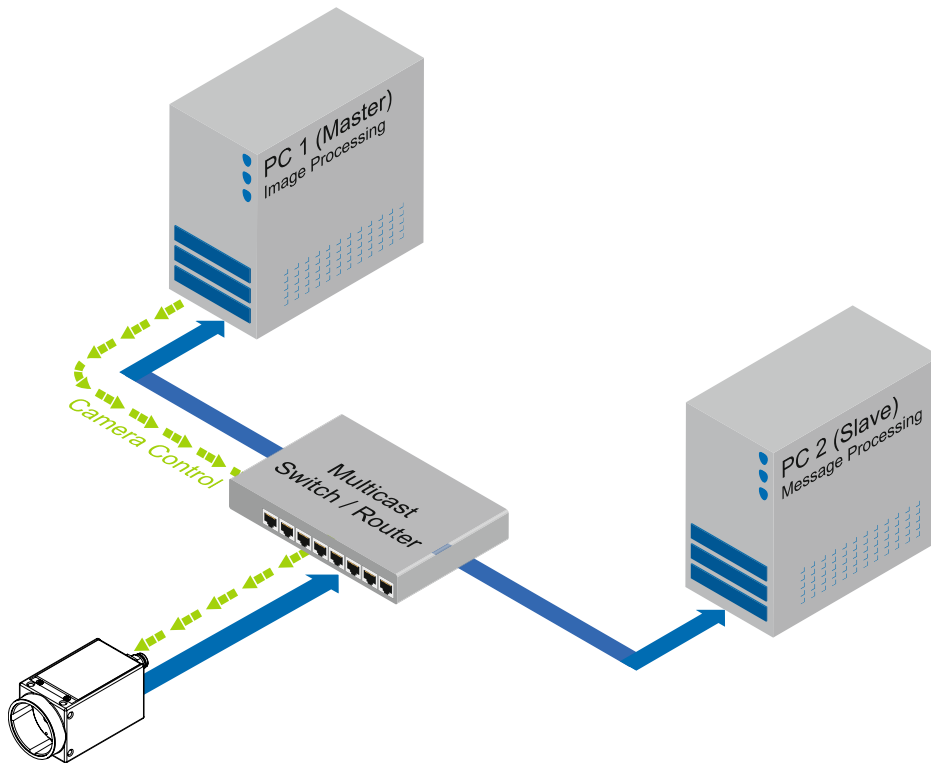

Multicast Addresses: For multicasting Bauer suggests an address range from 232.0.1.0 to 232.255.255.255.
--

8.6 IP Configuration

8.6.1 Persistent IP

A persistent IP address is assigned permanently. Its validity is unlimited.

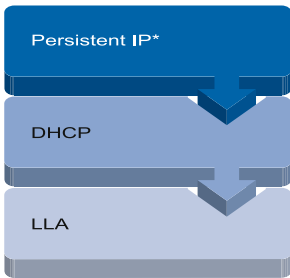

Connection pathway for Baumer Gigabit Ethernet cameras:

The device connects step by step via the three described mechanisms.

Notice

Please ensure a valid combination of IP address and subnet mask.

IP range:	Subnet mask:
0.0.0.0 – 127.255.255.255	255.0.0.0
128.0.0.0 – 191.255.255.255	255.255.0.0
192.0.0.0 – 223.255.255.255	255.255.255.0

These combinations are not checked by Baumer GAPI, Baumer GAPI Viewer or camera on the fly. This check is performed when restarting the camera, in case of an invalid IP - subnet combination the camera will start in LLA mode.

* This feature is disabled by default.

8.6.2 DHCP (Dynamic Host Configuration Protocol)

The DHCP automates the assignment of network parameters such as IP addresses, subnet masks and gateways. This process takes up to 12 sec.

Once the device (client) is connected to a DHCP-enabled network, four steps are processed:

- DHCP Discovery

In order to find a DHCP server, the client sends a so called DHCPDISCOVER broadcast to the network.

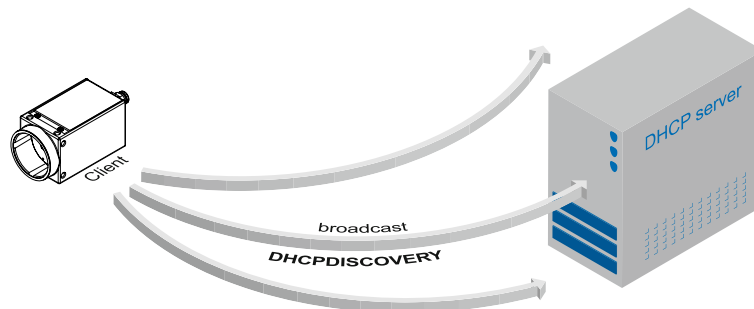

- DHCP Offer

After reception of this broadcast, the DHCP server will answer the request by an unicast, known as DHCPOFFER. This message contains several items of information, such as:

Information for the client	MAC address
	offered IP address
Information on server	IP address
	subnet mask
	duration of the lease

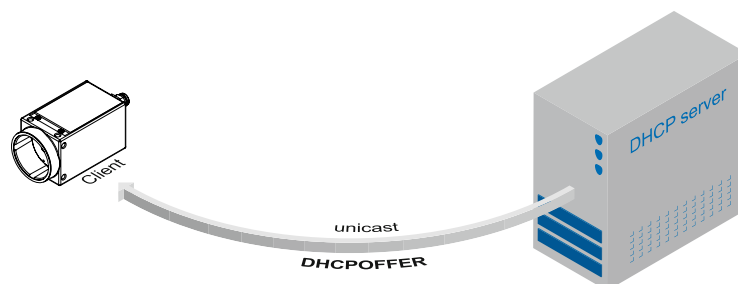

DHCP:

Please pay attention to the DHCP Lease Time.

DHCP Discovery
(broadcast)

DHCP offer (unicast)

- DHCP Request

Once the client has received this DHCP OFFER, the transaction needs to be confirmed. For this purpose the client sends a so called DHCPREQUEST broadcast to the network. This message contains the IP address of the offering DHCP server and informs all other possible DHCP servers that the client has obtained all the necessary information, and there is therefore no need to issue IP information to the client.

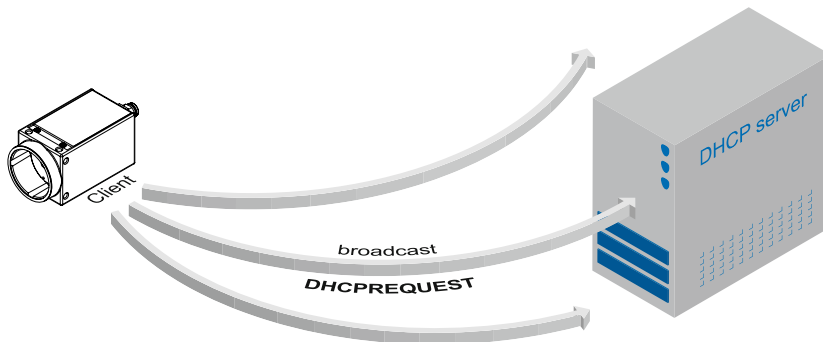

DHCP Request (broadcast)

- DHCP Acknowledgement

Once the DHCP server obtains the DHCPREQUEST, an unicast containing all necessary information is sent to the client. This message is called DHCPACK. According to this information, the client will configure its IP parameters and the process is complete.

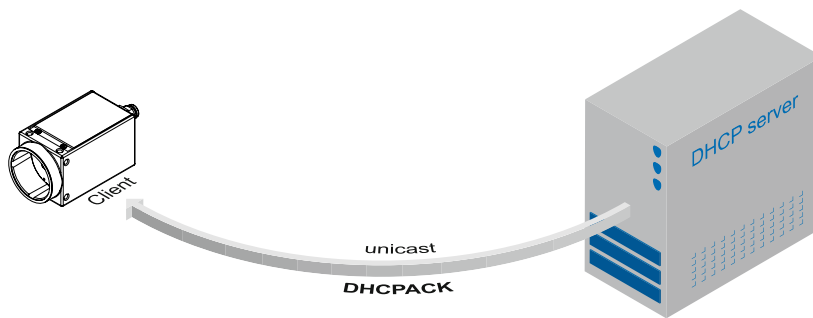

DHCP Acknowledgement (unicast)

<p>DHCP Lease Time: <i>The validity of DHCP IP addresses is limited by the lease time. When this time is elapsed, the IP configuration needs to be redone. This causes a connection abort.</i></p>
--

8.6.3 LLA

LLA (Link-Local Address) refers to a local IP range from 169.254.0.1 to 169.254.254.254 and is used for the automated assignment of an IP address to a device when no other method for IP assignment is available.

The IP address is determined by the host, using a pseudo-random number generator, which operates in the IP range mentioned above.

Once an address is chosen, this is sent together with an ARP (Address Resolution Protocol) query to the network to check if it already exists. Depending on the response, the IP address will be assigned to the device (if not existing) or the process is repeated. This method may take some time - the GigE Vision® standard stipulates that establishing connection in the LLA should not take longer than 40 seconds, in the worst case it can take up to several minutes.

<p>LLA: <i>Please ensure operation of the PC within the same subnet as the camera.</i></p>
--

8.6.4 Force IP¹⁾

Inadvertent faulty operation may result in connection errors between the PC and the camera. In this case "Force IP" may be the last resort. The Force IP mechanism sends an IP address and a subnet mask to the MAC address of the camera. These settings are sent without verification and are adapted immediately by the client. They remain valid until the camera is de-energized.

1) In the GigE Vision® standard, this feature is defined as "Static IP".

8.7 Packet Resend

Due to the fact, that the GigE Vision® standard stipulates using a UDP - a stateless user datagram protocol - for data transfer, a mechanism for saving the "lost" data needs to be employed.

Here, a resend request is initiated if one or more packets are damaged during transfer and - due to an incorrect checksum - rejected afterwards.

On this topic one must distinguish between three cases:

8.7.1 Normal Case

In the case of unproblematic data transfer, all packets are transferred in their correct order from the camera to the PC. The probability of this happening is more than 99%.

Data stream without damaged or lost packets.

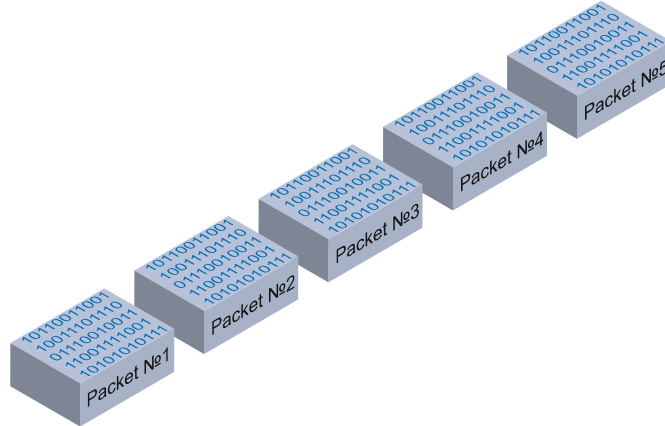

8.7.2 Fault 1: Lost Packet within Data Stream

If one or more packets are lost within the data stream, this is detected by the fact, that packet number n is not followed by packet number $(n+1)$. In this case the application sends a resend request (A). Following this request, the camera sends the next packet and then resends (B) the lost packet.

Resending lost packets within the data stream.

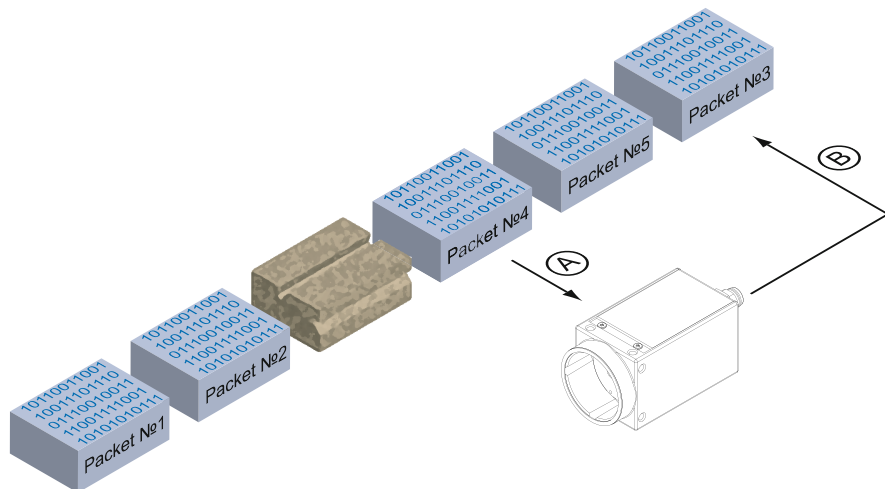

In our example packet no. 3 is lost. This fault is detected on packet no. 4, and the resend request triggered. Then the camera sends packet no. 5, followed by resending packet no. 3.

8.7.3 Fault 2: Lost Packet at the End of the Data Stream

In case of a fault at the end of the data stream, the application will wait for incoming packets for a predefined time. When this time has elapsed, the resend request is triggered and the "lost" packets will be resent.

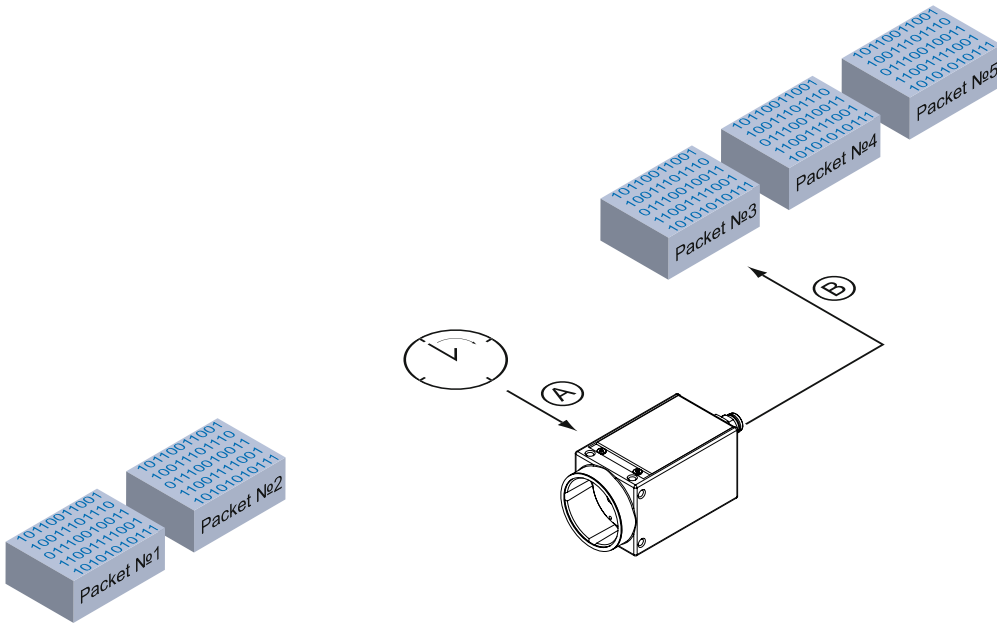

Resending of lost packets at the end of the data stream.

In our example, packets from no. 3 to no. 5 are lost. This fault is detected after the predefined time has elapsed and the resend request (A) is triggered. The camera then resends packets no. 3 to no. 5 (B) to complete the image transfer.

8.7.4 Termination Conditions

The resend mechanism will continue until:

- all packets have reached the pc
- the maximum of resend repetitions is reached
- the resend timeout has occurred or
- the camera returns an error.

8.8 Message Channel

The asynchronous message channel is described in the GigE Vision® standard and offers the possibility of event signaling. There is a timestamp (64 bits) for each announced event, which contains the accurate time the event occurred.

Each event can be activated and deactivated separately.

8.8.1 Event Generation

Event		Description
GenICam™		
ExposureStart		Exposure started
ExposureEnd		Exposure ended
FrameStart		Acquisition of a frame started
FrameEnd		Acquisition of a frame ended
Line0RisingEdge		Rising edge detected on IO-Line 0
Line0FallingEdge		Falling edge detected on IO-Line 0
Line1RisingEdge		Rising edge detected on IO-Line 1
Line1FallingEdge		Falling edge detected on IO-Line 1
Line2RisingEdge		Rising edge detected on IO-Line 2
Line2FallingEdge		Falling edge detected on IO-Line 2
Line3RisingEdge		Rising edge detected on IO-Line 3
Line3FallingEdge		Falling edge detected on IO-Line 3
Line4RisingEdge		Rising edge detected on IO-Line 4
Line4FallingEdge		Falling edge detected on IO-Line 4
Line5RisingEdge		Rising edge detected on IO-Line 5
Line5FallingEdge	(VCXG.I /	Falling edge detected on IO-Line 5
Line6RisingEdge	.XT / .PTP /	Rising edge detected on IO-Line 6
Line6FallingEdge	.I.PTP only)	Falling edge detected on IO-Line 6
Line7RisingEdge		Rising edge detected on IO-Line 7
Line7FallingEdge		Falling edge detected on IO-Line 7
Vendor-specific		
EventError		Error in event handling.
EventLost		Occured event not analyzed.
TriggerReady		t_{notready} elapsed, camera is able to process incoming trigger.
TriggerOverlapped		Overlapped Mode detected.
TriggerSkipped		Camera overtriggered.
FrameTransferSkipped		Frame lost in the camera.
TransferBufferFull		No free buffer in camera memory.
TransferBufferReady		Buffer available in camera memory.
HeartBeatTimeout		The device runs in heartbeat timeout.
PrimaryApplicationSwitch		For systems where redundancy and fault recovery are required, it is often necessary for a second application to take control over the camera that is already under the control of a primary application. In order to notify the primary application that a switchover has occurred, send this event before granting access to new primary application.

8.9 Action Command / Trigger over Ethernet

The basic idea behind this feature was to achieve a simultaneous trigger for multiple cameras.

Therefore a broadcast Ethernet packet was implemented. This packet can be used to induce a trigger as well as other actions.

Due to the fact that different network components feature different latencies and jitters, the trigger over the Ethernet is not as synchronous as a hardware trigger. Nevertheless, applications can deal with these jitters in switched networks, and therefore this is a comfortable method for synchronizing cameras with software additions.

The action command is sent as a broadcast. In addition it is possible to group cameras, so that not all attached cameras respond to a broadcast action command.

Such an action command contains:

- a Device Key - for authorization of the action on this device
- an Action ID - for identification of the action signal
- a Group Key - for triggering actions on separated groups of devices
- a Group Mask - for extension of the range of separate device groups
- a Action Time - only present for Scheduled Action Commands when a future action time is specified (.PTP only)

Action Command:
<i>Since hardware release 2.1 the implementation of the Action Command follows the regulations of the GigE Vision® standard 1.2.</i>

8.9.1 Example: Triggering Multiple Cameras

The figure below displays three cameras, which are triggered synchronously by a software application.

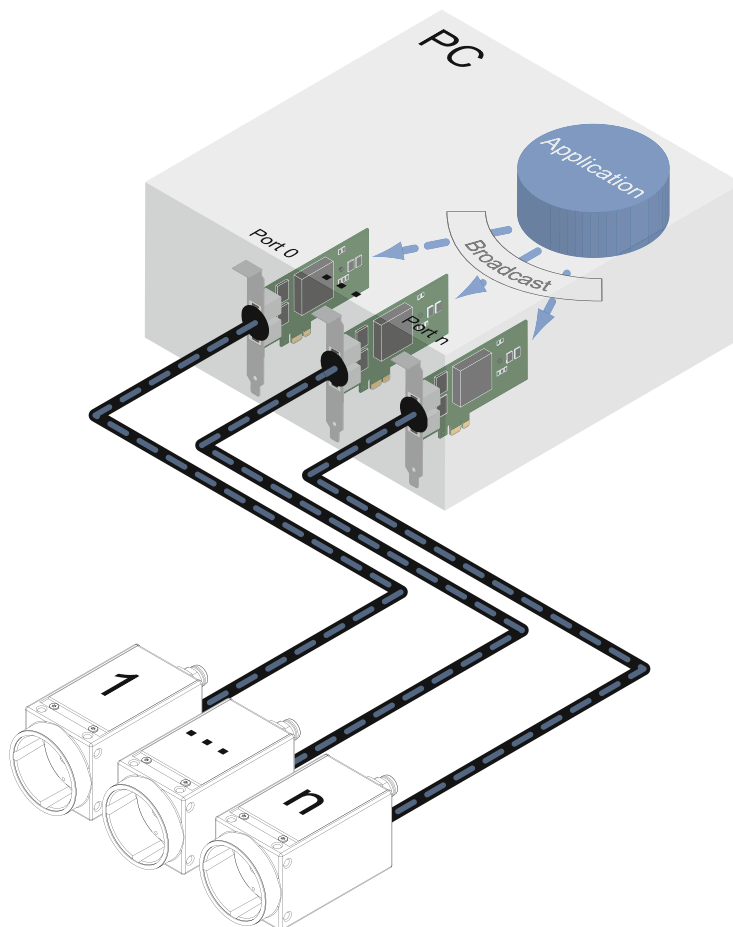

Triggering of multiple cameras via trigger over Ethernet (ToE).

Another application of action command is that a secondary application or PC or one of the attached cameras can actuate the trigger.

9. VCXU – Interface Functionalities

9.1 Device Information

This information on the device is part of the camera's USB descriptor.

Included information:

- Vendor ID (VID)
- Product ID (PID)
- General Unique Identifier (GUID)
- Device vendor name (Manufacturer)
- Serial number (iSerialNumber)

Model Name	Baumer USB Vendor ID [Hexadecimal]	Baumer USB Product ID [Hexadecimal]
VCXU	2825	0171

