

¹⁾ Sensor readout, different from pixel format

²⁾ Depends on the used interface



Sensor Information

| | |
|------------|----------------------------|
| Model Name | Sony IMX530 |
| Type | 4/3" progressive scan CMOS |
| Shutter | Global Shutter |
| Resolution | 5312 x 4592 pixels |
| Scan Area | 14.55 mm x 12.6 mm |
| Pixel Size | 2.74 µm x 2.74 µm |

Data Quality

@ 20 °C, gain = 1, exposure time = 4 msec

| | |
|---------------------------|--|
| Dark Noise (σ) | 2.2 e- typical |
| Saturation | 9000 e- typical |
| Dynamic Range | 72 dB typical |
| SNR | 40 dB typical |
| Quantum efficiency η | 46% @ 465 nm, 54% @ 536 nm, 43% @ 631 nm typical |

Acquisition

| | | | |
|---|--|-------------|---|
| Resolution | 5312 px x 4592 px | | |
| Interface Frame Rate (depends on used interface performance) | Format | Resolution | max. Frame Rate (@ Trigger Mode) ²⁾ |
| | Full Frame | 5312 x 4592 | 50 fps |
| | Binning 2x2 | 2656 x 2296 | 62 fps |
| | Binning 2x1 | 2656 x 4592 | 62 fps |
| | Binning 1x2 | 5312 x 2296 | 62 fps |
| Acquisition Frame Rate ¹⁾ (Burst Mode) | 62 fps $t_{\text{readout}} = 15.95$ msec (max. Res. Full Frame) @ 8 bit | | |
| | 54 fps $t_{\text{readout}} = 18.2$ msec (max. Res. Full Frame) @ 10 bit | | |
| | 44 fps $t_{\text{readout}} = 22.4$ msec (max. Res. Full Frame) @ 12 bit | | |
| Pixel Formats | BayerRG8, BayerRG10, BayerRG12, BayerRG12p, Mono8, Mono10, Mono12, Mono12p, RGB8, BGR8 | | |
| Partial Scan | True Partial Scan with increasing Frame Rate on Y direction, Region of Interest (ROI) arbitrary Width: minimum 64, increment 32 Height: minimum 2, increment 2 | | |
| Multi ROI | Up to 8 non-overlapping regions | | |
| Ad. Acquisition Frame Rate | Off or 0.01 ... 65535 Hz | | |
| Acquisition Mode | Continuous, Single Frame and Multi Frame | | |
| Acquisition Status | AcquisitionActive, AcquisitionTrigger Wait | | |
| Exposure Mode | Timed | | |
| Readout Mode | Overlapped, Sequential | | |

Image Pre-Processing

| | |
|-------------------------|---|
| Analog Controls | Exposure Time (1 µsec ... 60 sec Step Size 1 µsec) Gain (0...48 dB), Offset (0 ... 255 LSB 12 bit) |
| Auto Functions | ExposureAuto and GainAuto with BrightnessAutoPriority based on BrightnessAuto ROI |
| Gamma Correction | Gamma (0.1 ... 2 available if LUT is enabled) |
| LUT | Luminance (12 bit) |
| Color Models | Raw Bayer |
| Color Processing | - |
| Color Enhancement | - |
| Color Tolerance | - |
| Binning | Horizontal: 1 or 2, Vertical: 1 or 2 |
| Image Flipping | Horizontal, vertical |
| Defect Pixel Correction | via Defect Pixel List with up to 512 Pixel Coordinates |
| Shading Correction | Brightness correction per tile of 64x64 pixels |
| Sharpening | - |
| HDR | - |
| Image Compression | - |

Digital Input / Output: principle circuit diagram

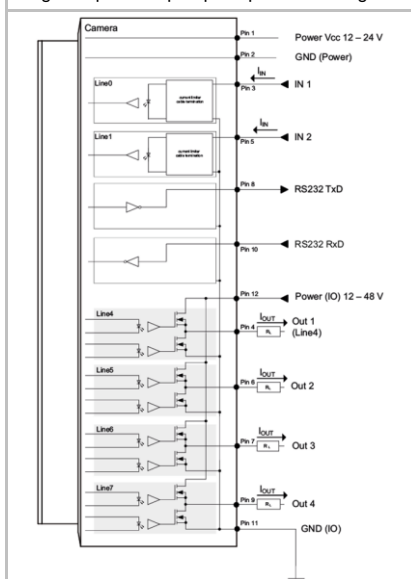

Trigger Mode: Start up time and valid Trigger

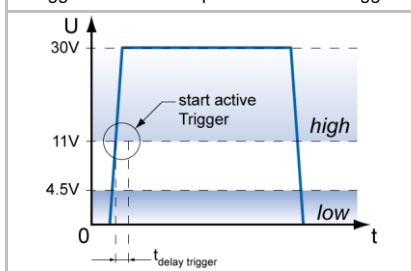

Process Synchronization

| | |
|--|---|
| Trigger Mode | Off (Free Running), On (Trigger) |
| Trigger Overlap Type | Readout |
| Trigger Sources | Hardware (Line0,1), Software, All, ActionCMD (Action 1) or Off fixed Trigger Delay out of t _{readout} : ¹⁾ 67 µsec @ 8 bit 73.5 µsec @ 10 bit 67 µsec @ 12 bit max. Trigger Delay during t _{readout} : ¹⁾ 67 µsec @ 8 bit 73.5 µsec @ 10 bit 67 µsec @ 12 bit |
| Trigger Delay | 0 ... 2 sec, Tracking and buffering of up to 256 triggers |
| External Flash Sync | via Exposure Delay Active t _{delay flash} ≤ 1 µsec, t _{duration} = t _{exposure} |
| Encoder Function | yes, via Counter and Trigger Source |
| Precision Time Protocol (PTP) Function | IEEE1588-2008 clock synchronization, default profile 1.0, master and slave mode |

Digital I/Os

| | |
|---------------------|--|
| Lines | Input: Line 0 .. 1, Output: Line 4 .. 7, GPIO: no, RS232: Line 2 .. 3 (reserved for future use) |
| Output Sources | Off, ExposureActive, Timer1, ReadoutActive, UserOutput 1-3 and TriggerReady |
| Output Line Mode | yes, Tri-State, PushPull, OpenDrain, OpenSource |
| Output PWM function | yes, Line 4 .. 7 PWM Mode: Off, One Pulse, FixedFrequency PWM feature: PWMDuration, PWMDutyCycle Configuration Mode for lightning protection: MaxPWMDuration, MaxPWMDutyCycle |
| Line Debouncer | Low and high signal separately selectable Debouncing Time 0 ... 5 msec, Step Size: 1 µsec |

Memory

| | |
|---------------------|---|
| Image Buffer | 1024 MB 42 Images (Trigger Mode) / 1 Image (Free Running Mode) |
| Non-volatile Memory | 128 kb |

Network Interface Data

| | | | |
|-------------|---|--------------------------|-----------------|
| Interface | 10 Gigabit Ethernet | 10GBASE-T | 10.000 Mb/s/sec |
| | 5 Gigabit Ethernet | 5GBASE-T | 5.000 Mb/s/sec |
| | 2.5 Gigabit Ethernet | 2.5GBASE-T | 2.500 Mb/s/sec |
| | Gigabit Ethernet | 1000BASE-T | 1.000 Mb/s/sec |
| | Fast Ethernet | 100BASE-T | 100 Mb/s/sec |
| | Ethernet IP Configuration | Persistent IP, DHCP, LLA | |
| Packet Size | 576 ... 9000 Byte, Jumbo Frames supported | | |

GigE Vision® Features

| | |
|---|--|
| Events | DeviceTemperatureStatusChanged, EventLost, ExposureEnd, ExposureStart, FrameEnd, FrameStart, FrameTransferSkipped, Error, GigE Vision Heartbeat Timeout, Line0..3 FallingEdge, Line0..3 RisingEdge, PrimaryApplicationSwitch, TransferBufferFull, TransferBufferReady, TriggerOverlapped, TriggerReady, TriggerSkipped |
| Transmission via Asynchronous Message Channel | |
| Action CMD | yes, Action 1 for Trigger |
| Frame Counter | up to 2 ³² |
| Payload Size | 0 ... 73178352 Byte |
| Timestamp | 64 bit, resolution in nsec, increment = 8 |
| Packet Delay | 0 .. 2 ³² - 1 nsec |
| Packet Resend | |
| GigE Vision | v2.0 |

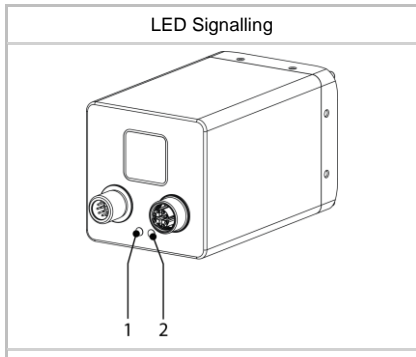
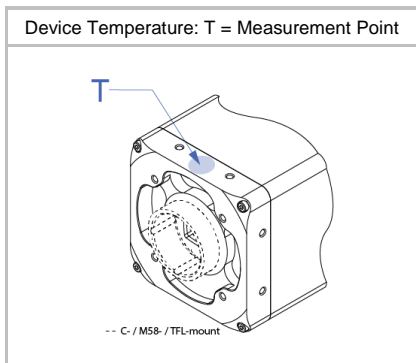
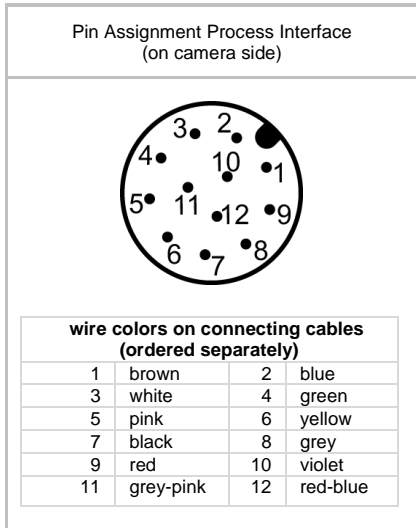

Interfaces and Connectors

| Data and Power Interface | 10 Gigabit Ethernet | Transfer Rate | 10.000 Mbits/sec |
|--------------------------|---|---------------|------------------|
| | 5 Gigabit Ethernet | Transfer Rate | 5.000 Mbits/sec |
| | 2.5 Gigabit Ethernet | Transfer Rate | 2.500 Mbits/sec |
| | Gigabit Ethernet | Transfer Rate | 1.000 Mbits/sec |
| | Fast Ethernet | Transfer Rate | 100 Mbits/sec |
| Connector: | M12 / 8-pol x-coded (SACC-CI-M12FS-8CON-L180-10G) | | |
| Assignment: | 1 - MX1+ | 2 - MX1- | |
| | 3 - MX2+ | 4 - MX2- | |
| | 5 - MX4+ | 6 - MX4- | |
| | 7 - MX3- | 8 - MX3+ | |

| Process Interface | Connector: | M12/12-pin a-coded (SACC-CI-M12MS-12CON-L180) |
|-------------------|------------------|---|
| Assignment: | 1 - Power Vcc | 2 - GND (Power) |
| | 3 - IN1 (Line0) | 4 - OUT1 (Line4) |
| | 5 - IN2 (Line1) | 6 - OUT2 (Line5) |
| | 7 - OUT3 (Line6) | 8 - RS232 TxD (Line2) |
| | 9 - OUT4 (Line7) | 10 - RS232 RxD (Line3) |
| | 11 - GND (IO) | 12 - Power (IO) |

| Lens Control Interface (located within support, reserved for future use) | Connector: | 6 pin (JST BM06B-SRSS-TB) |
|--|------------------|---------------------------|
| Assignment: | 1 - Power (lens) | 2 - GND (lens) |
| | 2 - UART RxD | 4 - UART TxD |
| | 5 - NC | 6 - NC |

Optical Data

| | |
|----------------|-----------|
| Lens Mount | TFL-Mount |
| Optical Filter | - |

Mechanical Data

| | |
|---------|---|
| Housing | aluminum, hard anodized, IP40 (with mounted lens and 10 GigE cable) IP65/67 (with mounted tube and cable) |
|---------|---|

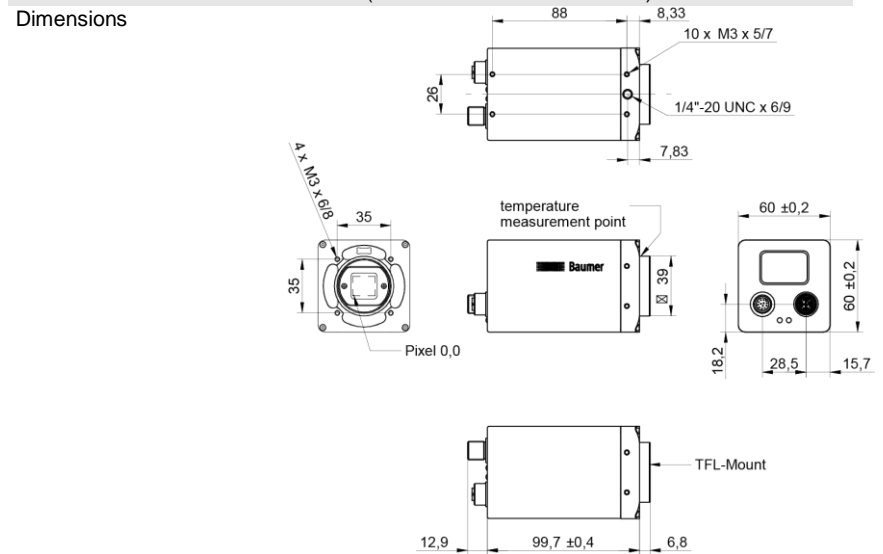

| | |
|--------|-------|
| Weight | 485 g |
|--------|-------|

Environmental Data

| | |
|-----------------------------|---|
| Storage Temperature | -10 °C ... + 70 °C |
| Operating Temperature *) | 0 °C ... +60 °C @ T = Measurement Point or 0 °C ... +69 °C @ internal Temperature Sensor Ambient temperature above 26 °C requires heat dissipation measures. |
| Int. Temperature Sensor | yes, accuracy: ±2 °C (typ) -40 °C ... 0 °C ±1 °C (typ) 0 °C ... +85 °C |
| Humidity | 10 % ... 90 % non-condensing |

*) the maximum temperature for Sony sensor characteristics (sensor performance) are guaranteed up to 50°C @ Measurement Point or 55°C @ internal temperature sensor

LED Signaling

| | | |
|-----|--------------|-----------|
| LED | Green flash | RX active |
| | Green | Link ON |
| | Yellow | Error |
| | Yellow flash | TX active |

Optional accessories for IP65/67 protection (ordered separately)



Tube Adapter

including seals and screws

| Article Number | Diameter | Length |
|----------------|----------|--------|
| 11193125 | Ø 65 mm | 2 mm |

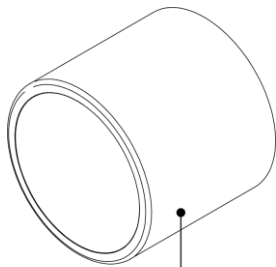

tube

| Article Number | Diameter | Cover Glass | Length |
|----------------|----------|---------------------------------|--------|
| 11185374 | Ø 65 mm | Acryl | 58 mm |
| 11195426 | Ø 65 mm | Tempered laminated safety glass | 58 mm |



distance ring

including seal

| Article Number | Diameter | Length |
|----------------|----------|--------|
| 11185376 | Ø 65 mm | 6 mm |
| 11185375 | Ø 65 mm | 12 mm |
| 11198906 | Ø 65 mm | 36 mm |

Electrical Data

| | |
|------------------------------------|---|
| Power Supply (ext.) | VCC: 24 V DC ± 20% I: 532 mA |
| Power over Ethernet | NA |
| Power Consumption | approx. 12.8 W @ 24VDC and 50 fps (Factory Setting "Default") |
| Digital Input | Isolated, short circuit protection U _{IN(low)} : 0.0 ... 4.5 VDC U _{IN(high)} : 11.0 ... 30.0 VDC I _{IN} : 3.0 ... 10.0 mA min. Impulse Length: 2.0 µsec |
| Digital Output | Isolated, short circuit protected U _{EXT} : 12 ... 48 V DC [Power (IO)] I _{OUT} : Continuously: max. 1.5 A PWM t _{ON} max 1s / Duration max 40%: max. 2.5 A (Max. current for each output itself or summery of all outputs) t _{ON} = < 0.2 µsec t _{OFF} = < 0.2 µsec max. Frequency: 500 kHz |
| GPIO | NA |
| RS232 (reserved for future use) | RS232 compatible, not optically isolated Baud Rate: up to 115200, data bits: 8, stop bits: 1, Parity: none, flow control: none |
| Liquid lens control | Support for Varioptic Caspian C-39N0 series (C-C-39N0-160-R33, C-C-39N0-250-R33, up to 2/3") VCC: 5 V DC ± 20% , I: 100 mA, UART 3.3 V |

Conformity

| | |
|----------------------------|--|
| Conformity | CE, RoHS, REACH, EAC |
| KC Registration No. / Date | - / - |
| MTBF | 26 years @ T = 45 °C / 17 years @ T = 60 °C T = Measurement Point |

GenICam™ Features

| | |
|----------------------|---|
| Short Exposure Range | yes, ShortExposureTimeEnable Short Exposure Range 1 µsec ... 60 sec Default Exposure Range 8 µsec ... 60 sec |
| Timer | Timer Selector: Timer 1 TimerTriggerSource: Line0, SoftwareTrigger, ExposureStart, ExposureEnd, FrameTransferSkipped, TriggerSkipped, Action 1 and Off TimerDelay: 0 µsec ... 2 sec, Step Size: 1 µsec TimerDuration: 4 µsec ... 2 sec, Step Size: 1 µsec |
| Counter | Counter Selector: Counter 1, Counter 2 CounterValue: 0 ... 65535 Counter Event Source: Counter1End or Counter2End, ExposureActive, FrameTransferSkipped, FrameTrigger, TriggerSkipped and Off Counter Reset Source: Counter1End, Counter2End, Line0 and Off |
| Sequencer | Sequencer Characteristics: up to 128 sets, up to 4 possible paths for triggered set transitions, 6 trigger sources: Counter1End, Counter2End, ExposureActive, Line0, ReadoutActive, Timer1End Sequencer Parameters for Exposure, Gain, Trigger, ROI and Output: ExposureTime, CounterDuration, CounterEventActivation, CounterEventSource, CounterResetSource, ExposureMode, ExposureTime, Gain, Height, OffsetX, OffsetY, TriggerMode, UserOutputValue, UserOutputValueAll, Width |

GenICam™ Features

| | |
|------------------------------|---|
| User Sets | Factory Settings: UserSet0 (read only) Freely Programmable: UserSet1, UserSet2, UserSet3 Parameters: any user definable Parameter |
| Acquisition Abort | Delay up to 22.4 msec |
| Chunk Data | yes, Chunk Selector: Binning, Black Level, DeviceTemperature, ExposureTime, FrameID, Gain, Height, Image, ImageControl, LineStatusAll |
| Device Temperature | InHouse Event generation for Normal to High, High to Exceeded and Exceeded to Normal Exceeded (no image transfer) = max. internal temperature sensor + 1 °C |
| Device Link Throughput Limit | yes, up to max. Device Link Speed |
| Custom Data | yes, 128 Byte |
| SFNC Version | v2.4.0 |

Factory Settings after Start-Up

| | |
|--------------------------------|--|
| Trigger Mode | Off (Free Running) |
| Analog Controls | Exposure Time: 4 msec, Gain: 0 dB, Offset: 0 |
| Pixel Format | BayerRG8 |
| Partial Scan | Off |
| Acquisition Frame Rate | Off |
| Timer/Counter/Sequencer | Off |
| Defect Pixel Correction | ON |
| Fixed Pattern Noise Correction | - |
| Digital Input | Line0 .. 1, invert = false, line format = Tri State |
| Digital Output | Line4 .. 7, invert = false, line source = Off, line format = Open Source |
| GPIO | NA |
| TriggerSource | All |

ROI Frame Rates, min Exposure, 8 bit sensor readout, Mono8 or BayerRG8

| | Resolution | max. fps acquisition | max. fps interface ²⁾ |
|-----------|-------------|----------------------|----------------------------------|
| HXGA | 4096 x 3072 | 92 | 92 |
| UHD (4K) | 3840 x 2160 | 128 | 128 |
| Full HD | 1920 x 1080 | 240 | 240 |
| SXGA | 1280 x 1024 | 253 | 253 |
| XGA | 1024 x 768 | 323 | 323 |
| SVGA | 800 x 600 | 391 | 390 |
| VGA | 640 x 480 | 469 | 469 |
| CIF | 352 x 288 | 672 | 672 |
| QCIF | 176 x 144 | - | - |
| Full Line | 5312 x 4096 | 70 | 56 |
| | 5312 x 2048 | 135 | 112 |
| | 5312 x 1024 | 253 | 224 |
| | 5312 x 512 | 446 | 446 |
| | 5312 x 256 | 724 | 724 |
| | 5312 x 128 | 1050 | 1050 |
| | 5312 x 64 | 1355 | 1355 |
| | 5312 x 32 | 1585 | 1585 |
| | 5312 x 16 | 1733 | 1733 |
| | 5312 x 8 | 1733 | 1733 |
| | 5312 x 4 | 1733 | 1733 |
| | 5312 x 2 | 1733 | 1733 |
| | 5312 x 1 | - | - |

²⁾ depends on the used interface speed