

PT20S

Industrial compact RTD temperature sensor

PT20S-####.#####.2##000#.####

Overview

- Precision measurement from -50 ... 250 °C
- Integrated 4 ... 20 mA transmitter with high accuracy
- Fast power-up time < 2 s
- All parts welded together
- Customer-specific immersion depth down to 3000 mm
- IO-Link Dual Channel for easy commissioning



Picture similar



Technical data

Performance characteristics

Pt100 accuracy class (EN 60751)	1/1 B ± (0.3 + 0.005 × t)°C 1/1 A ± (0.15 + 0.002 × t)°C 1/3 B ± 1/3 × (0.3 + 0.005 × t)°C 1/6 B ± 1/6 × (0.3 + 0.005 × t)°C
Max. output error	≤ 0.06 % FSR @ 25 °C Including input accuracy, output accuracy and repeatability
Thermal response time, T90	RTD element and transmitter combined < 3.0 s, Ø3 mm < 8.5 s, Ø6 mm
Temperature drift (by ambient)	< 0.025 K/K + 0.01 % FSR/K
Process temperature	Refer to section "Operating conditions"

Process connection

Connection variants	Refer to section "Dimensional drawings"
Sensor length	≤ 3000 mm
Sensor diameter outside	Ø 6 mm
Mounting position	Any, top, bottom, side
Standard response tip	Ø 6 mm
Fast response tip	Ø 3 mm
Sensor tube material	AISI 316L (1.4404)
Surface roughness wetted parts	Ra ≤ 0.8 µm

Ambient conditions

Operating temperature range	-40 ... 85 °C
Storage temperature range	-50 ... 85 °C

Ambient conditions

Degree of protection (EN 60529)	Connector DIN EN 175301-803 A (DIN 43650 A), 4-pin: IP65 Connector M12-A, 4-pin: IP68, with appropriate cable (336 h @ 10 mH2O) IP69K, with appropriate cable
Humidity	≤ 100 % RH, condensing
Vibration (sinusoidal) (EN 60068-2-6)	1.6 mm p-p (2 ... 25 Hz), 4 g (25 ... 100 Hz), 1 octave / min. GL, test 2

IO-Link interface

IO-Link version	1.1
Device profile	Smart Sensor Profile
IO-Link port type	Class A
Baud rate	38,4 kbaud (COM2)
Process data length	72 bit
SIO-mode	Yes
Process data (cyclic)	Switch state State of alert Process temperature Unit temperature Signal analog output 1
Dual Channel	IO-Link / Analogue

Housing

Style	Compact transmitter
Overall size	Refer to section "Dimensional drawings"
Material	AISI 304 (1.4301)

Electrical connection

Connector	DIN EN 175301-803 A (DIN 43650 A), 4-pin M12-A, 4-pin
-----------	--

PT20S

Industrial compact RTD temperature sensor

PT20S-####.#####.2##000#.####

Technical data

Power supply

Voltage supply range	7 ... 35 V DC (Standard version) 10 ... 35 V DC (Dual Channel version) 18 ... 30 V DC (Dual Channel version, IO-Link communication)
Power-up time	< 2 s
Reverse polarity protection	Yes

Factory settings

Output range	0 ... 150 °C
Damping	0 s
Output at sensor fault	23 mA

Compliance and approvals

EMC	EN 61326-1
Safety	cULus listed, E527512

Transmitter

Input

Min. measuring span	10 °C
Sample time	< 0.1 s
Accuracy	0.05 °C (-50 ... 200 °C) 0.06 °C (200 ... 250 °C)
Error detection delay	< 2 s

Output

Output type	PNP NPN Digital (push-pull) 4 ... 20 mA, 2-wire 20 ... 4 mA, 2-wire
Switching logic	Active high Active low
Voltage drop	PNP: (+Vs - 1,2 V) ± 0.5 V, Rload ≥ 10 kΩ NPN: (-Vs + 1,5 V) ± 0.5 V, Rload ≥ 10 kΩ
Resolution	14 bit
Ripple immunity	< 1 % FSR (1 Vrms, 50Hz...1kHz)
Shunt resistance	Rs ≤ (V DC - 7 V)/0.023 A (Standard version) Rs ≤ (V DC - 10 V)/0.023 A (Dual Channel version)
Current rating	100 mA, max.
Off leak current	< 100 µA
Short circuit protection	Yes
Damping	0.0 ... 60.0 s, programmable
Up/Down scaling limits	23 mA / 3.5 mA

Operating conditions

Ordering key	Process connection	BCID	Process pressure (bar)	Continuous		
				Process temperature Standard @ Tamb ≤ 20 °C (° C)	Process temperature With cooling neck, Sensor tip Ø3 mm @ Tamb ≤ 20 °C (° C)	Process temperature With cooling neck, Sensor tip Ø6 mm @ Tamb ≤ 20 °C (° C)
T650	Sleeve Ø 6	T65	-1 ... 40	-50 ... 125	-50 ... 200	-50 ... 250
G060	G 1/2 A ISO 228-1	G06	-1 ... 100	-50 ... 125	-50 ... 200	-50 ... 250
G500	G 1/4 A DIN 3852-E	G50	-1 ... 100	-50 ... 125	-50 ... 200	-50 ... 250
G510	G 1/2 A DIN 3852-E	G51	-1 ... 100	-50 ... 125	-50 ... 200	-50 ... 250
N020	1/2-14 NPT	N02	-1 ... 100	-50 ... 125	-50 ... 200	-50 ... 250

For further information on permissible process and ambient temperatures, please refer to the operating instructions.

PT20S

Industrial compact RTD temperature sensor

PT20S-####.#####.2##000#.####

Dimensional drawings (mm)

Housing

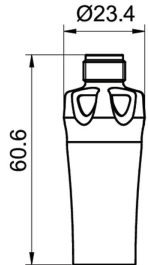

Housing with Dual Channel transmitter and KingCrown connector M12-A, 4-pin (with LED)

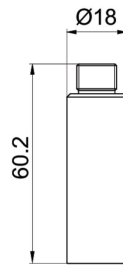

Housing with Dual Channel transmitter and connector M12-A, 4-pin

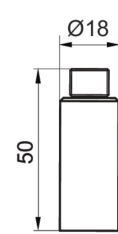

Housing with transmitter and connector M12-A, 4-pin

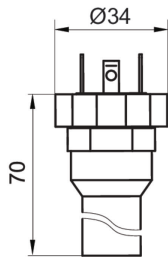

Housing with transmitter and connector DIN EN 175301-803 A (DIN 43650 A), 4-pin

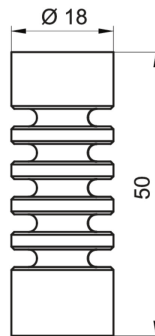

Cooling neck

Process connection

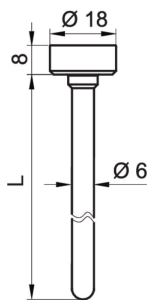

Without thread (BCID: T65)

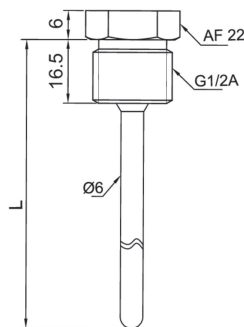

G 1/2 A ISO 228-1 (BCID: G06)

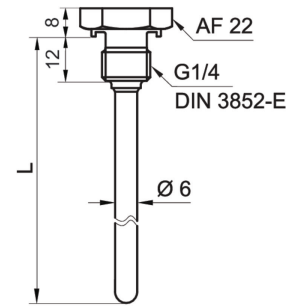

G 1/4 A DIN 3852-E (BCID: G50)

PT20S

Industrial compact RTD temperature sensor

PT20S-####.#####.2##000#.####

Dimensional drawings (mm)

Process connection

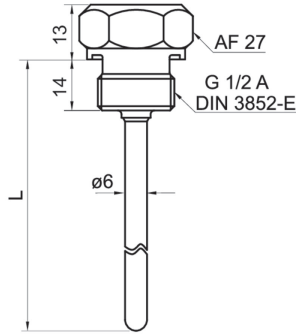

G 1/2 A DIN 3852-E (BCID: G51)

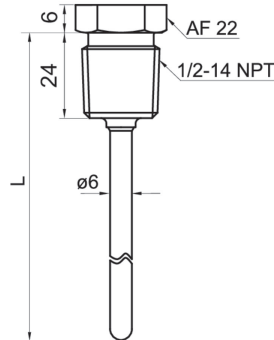

1/2-14 NPT (BCID: N02)



Standard response tip

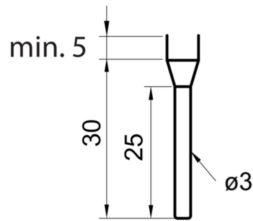

Fast response tip

Electrical connection

Output type	Electrical connection	Equivalent circuit	Function	Pin assignment							
	M12-A, 4-pin, stainless steel										
Standard version 4 ... 20 mA, 2-wire			<table border="1"> <tr><td>+Vs</td><td>1</td></tr> <tr><td>lout</td><td>2, 3</td></tr> <tr><td>N.C.</td><td>4</td></tr> <tr><td>Frame ground</td><td>Plug thread</td></tr> </table>	+Vs	1	lout	2, 3	N.C.	4	Frame ground	Plug thread
+Vs	1										
lout	2, 3										
N.C.	4										
Frame ground	Plug thread										
	DIN EN 175301-803 A (DIN 43650 A), 4-pin										
Standard version 4 ... 20 mA, 2-wire			<table border="1"> <tr><td>+Vs</td><td>1</td></tr> <tr><td>lout</td><td>2</td></tr> <tr><td>N.C.</td><td>3</td></tr> <tr><td>Frame ground</td><td>Grounding lug</td></tr> </table>	+Vs	1	lout	2	N.C.	3	Frame ground	Grounding lug
+Vs	1										
lout	2										
N.C.	3										
Frame ground	Grounding lug										

PT20S

Industrial compact RTD temperature sensor

PT20S-####.#####.2##000#.####

Electrical connection

Output type	Electrical connection	Equivalent circuit	Function	Pin assignment
	M12-A, 4-pin, stainless steel			
Dual Channel version 4 ... 20 mA, 2-wire			+Vs lout N.C. Frame ground	1 2 3, 4 Plug thread
Dual Channel version IO-Link + 4 ... 20 mA PNP			+Vs SW1 (IO-Link) lout GND (0 V) Frame ground	1 4 2 3 Plug thread
Dual Channel version IO-Link + 4 ... 20 mA NPN			+Vs SW1 (IO-Link) lout GND (0 V) Frame ground	1 4 2 3 Plug thread
Dual Channel version IO-Link + 4 ... 20 mA Digital (push-pull)			+Vs SW1 (IO-Link) lout GND (0 V) Frame ground	1 4 2 3 Plug thread

PT20S

Industrial compact RTD temperature sensor

PT20S-####.#####.2##000#.####

Ordering information

Ordering key - Configuration possibilities see website

Product	PT20S	-	####	.	#	#	#	#	#	#	#	.	2	#	#	0	0	0	#
Product	PT20S																		
Process connection																			
Sleeve Ø 6 (T65)																			T650
G 1/2 A ISO 228-1 (G06)																			G060
G 1/4 A DIN 3852-E (G50)																			G500
G 1/2 A DIN 3852-E (G51)																			G510
1/2-14 NPT (N02)																			N020
Sensor tip																			
Standard tip (Ø6 mm)																			1
Fast response tip (Ø3 mm)																			3
Sensor element																			
Pt100 1/1 B EN 60751, single, 2-wire																			1
Pt100 1/3 B EN 60751, single, 2-wire																			3
Pt100 1/6 B EN 60751, single, 2-wire																			5
Pt100 1/1 A EN 60751, single, 2-wire																			7
Pt100 1/1 B EN 60751, single, 4-wire																			A
Pt100 1/3 B EN 60751, single, 4-wire																			B
Pt100 1/6 B EN 60751, single, 4-wire																			C
Pt100 1/1 A EN 60751, single, 4-wire																			D
Cooling neck																			
Without cooling neck																			0
With cooling neck																			4
Process temperature																			
-50...125°C																			1
-50...200°C																			2
-50...250°C																			3
Max. process pressure																			
40 bar																			2
100 bar																			3
Interface																			
4...20 mA																			1
IO-Link Dual Channel, 4...20 mA																			2
Electrical connection																			
M12-A, 4 pin, stainless steel, with integrated transmitter																			2
M12-A, 4 pin, stainless steel KingCrown, with integrated transmitter (with LED)																			3
DIN EN 175301-803 A (DIN 43650 A), 4-pin, with integrated transmitter																			5
Wetted parts material																			
AISI 316L (1.4404)																			2
Surface roughness																			
Ra ≤ 0.8 µm																			1
Ra ≤ 0.4 µm																			2
Electropolished, Ra ≤ 0,8 µm																			3
Electropolished, Ra ≤ 0,4 µm																			4
Gasket material																			
Without																			0
NBR																			1
FKM																			2
EPDM																			3

PT20S

Industrial compact RTD temperature sensor

PT20S-####.#####.2##000#.####

Ordering information

Ordering key - Configuration possibilities see website

	PT20S	-	####	.	#	#	#	#	#	#	.	2	#	#	0	0	0	#
Explosion protection																		
Without																	0	
Industrial approvals																		
Standard																	0	
Special approvals																		
Standard																		0
Configuration																		
Factory settings																		0
Customer-specific																		1

(1) Including female power connector