

# Operation manual

## Flow sensor PF55S



**Read this manual prior to performing any task!**

Translation of the original German document, dated 4/3/2020 English

Baumer Electric AG  
Hummelstrasse 17  
CH – 8501 Frauenfeld  
Telephone: +49 777164741222  
E-mail: [mid.de@baumer.com](mailto:mid.de@baumer.com)  
Internet: [www.baumer.com](http://www.baumer.com)  
Translation of the original operation manual  
PF55, 4, en\_US

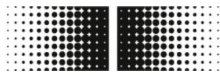

### **Information on the operating manual**

This manual is an integral part of the PF55S and must be kept within close proximity of the system for personnel to access at all times. This manual enables the device to be handled safely and efficiently. In the event of a resale, the PF55S manual must be handed over to the new owner.

Personnel must have carefully read through and understood this manual before starting any work. Following all safety guidelines and instructions in this manual is the basic prerequisite for safe work. Furthermore, the local health and safety regulations and general safety regulations for the field of application of the PF55S also apply.

The diagrams in this manual are examples. There may be differences at the discretion of Baumer.

Baumer will regularly update this operating manual. Should you notice that information is missing or that there is an error, please notify Baumer.

Contact Baumer if you have any questions concerning this manual.

### **Please help**

We, Baumer Group, constantly strive to improve our products.

Help us to make Baumer products even safer.

Notify us of each hazardous situation that occurs in relation to Baumer products:

- Hazards that arise from the product
- Hazards that arise from handling the product
- Hazards that arise due to contact between materials and the product

In this case, please include the following information, if known:

- Affected product
- Description of the hazardous situation
- Sketches, photos
- Name and contact information in case of any queries

Baumer will process the information as soon as possible.

### **Note on electrical parts**

Due to the sometimes very short innovation cycles for electrical parts, it is possible for the original manufacturer to withdraw products from the market early on (parts discontinuation).

This can mean that the availability of replacement parts being limited, and that the original assembly cannot be repaired. Therefore, in the event of repairs, Baumer Group reserves the right to replace the entire assembly concerned with another assembly with an identical or extended functionality.

### **Other applicable documents**

In addition to this document, the operating manual and the safety advice contained therein for the components of the PF55S and the higher-level machine also apply.



### Copyright protection

Baumer Group operating manuals and handbooks are protected by copyright. The copying, reproduction and translation, etc. of them is prohibited. Additional copies of this operating manual and copies in other languages can be obtained directly from Baumer.

The right to make changes at any time and without providing advance notice is reserved.

### Warranty

The contractually agreed warranties only apply if the maintenance work described within this operating manual is carried out at the prescribed intervals and the operating manual are adhered to. The instructions in the supplier's documentation must also be observed.

### Limitation of liability

All information and instructions in this operating manual have been compiled in accordance with the applicable norms and specifications, the current state of technology and our many years of experience and knowledge.

The manufacturer does not accept any liability for damage caused by the following:

- The operating manual was not followed.
- The system was not operated according to its intended use.
- Unqualified personnel were deployed.
- Unauthorized modifications were made.
- Unauthorized technical alterations were made.

The obligations agreed in the supply contract, the general terms and conditions, the manufacturer's and their supplier's delivery conditions and the legal regulations applicable at the time the contract is concluded shall apply.

### Customer service

Baumer MDS GmbH

Bodenseeallee 7

78333 Stockach

Germany

Tel.: +49 777164741222

Email: [mid.de@baumer.com](mailto:mid.de@baumer.com)

Website: [www.baumer.com](http://www.baumer.com)

A current list of local contacts can be found on our website under *Contact*.

**Table of contents**

<b>1</b>	<b>General</b> .....	<b>7</b>
<b>2</b>	<b>Safety and responsibility</b> .....	<b>8</b>
	2.1 Symbols in this manual.....	8
	2.2 Designated use.....	10
	2.3 Reasonably foreseeable misuse.....	10
	2.4 Work areas and danger zones.....	10
	2.5 Safety marking.....	11
	2.6 Securing against restart.....	11
	2.7 Responsibility of the owner.....	11
	2.8 Integrator responsibilities.....	13
	2.9 Immediate measures following an accident.....	14
	2.10 Personnel requirements.....	16
	2.11 Personal protective equipment.....	18
	2.12 Safety guidelines for transport and storage.....	19
	2.13 Safety guidelines for assembly and commis- sioning.....	20
	2.14 Safety guidelines for maintenance and resolving faults.....	23
	2.15 Safety information for replacement parts.....	24
<b>3</b>	<b>Layout and functional description</b> .....	<b>26</b>
	3.1 Structure.....	26
	3.2 Functional description.....	26
	3.3 Ports.....	27
	3.4 Control software BCP.....	28
<b>4</b>	<b>Transport and storage</b> .....	<b>29</b>
	4.1 Delivery.....	29
	4.2 Transport inspection.....	29
	4.3 Storage of packages.....	29
	4.4 Disposing of packaging materials.....	29
<b>5</b>	<b>Assembly and installation</b> .....	<b>31</b>
	5.1 Prerequisites for installation.....	31
	5.2 Installation position of the flow sensor.....	32
	5.3 Installation.....	35
	5.4 Electrical connection.....	38
<b>6</b>	<b>Commissioning</b> .....	<b>41</b>
	6.1 Create USB interface.....	41
	6.2 BCP software installation.....	42
<b>7</b>	<b>Operation</b> .....	<b>47</b>
	7.1 BCP Software.....	47
	7.2 Visualization view.....	50
	7.3 Quick start menu.....	53
	7.4 Access codes.....	53



7.5	Operation: Example.....	54
7.5.1	Operation: Example quick start menu.....	54
7.5.2	Operation: Example main menu.....	56
7.6	Menu navigation.....	58
7.6.1	Sensor menu.....	60
7.6.2	Units menu.....	62
7.6.3	Scales menu.....	66
7.6.4	Measure menu.....	68
7.6.5	Alarms menu.....	71
7.6.6	Inputs menu.....	73
7.6.7	Outputs menu.....	75
7.6.8	Communication menu.....	79
7.6.9	Display menu.....	80
7.6.10	Functions menu.....	81
7.6.11	Diagnostic menu.....	82
7.6.12	System menu.....	87
7.6.13	Process data menu.....	90
<b>8</b>	<b>Maintenance.....</b>	<b>92</b>
8.1	External cleaning.....	92
8.2	Internal cleaning.....	92
8.3	Replacing the seals.....	92
<b>9</b>	<b>Fault elimination.....</b>	<b>93</b>
9.1	Alarms.....	93
9.2	Error messages.....	95
<b>10</b>	<b>Disassembly and disposal.....</b>	<b>97</b>
<b>11</b>	<b>Technical data.....</b>	<b>98</b>
<b>12</b>	<b>Replacement parts.....</b>	<b>102</b>
<b>13</b>	<b>Index.....</b>	<b>103</b>

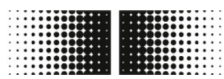

## 1 General

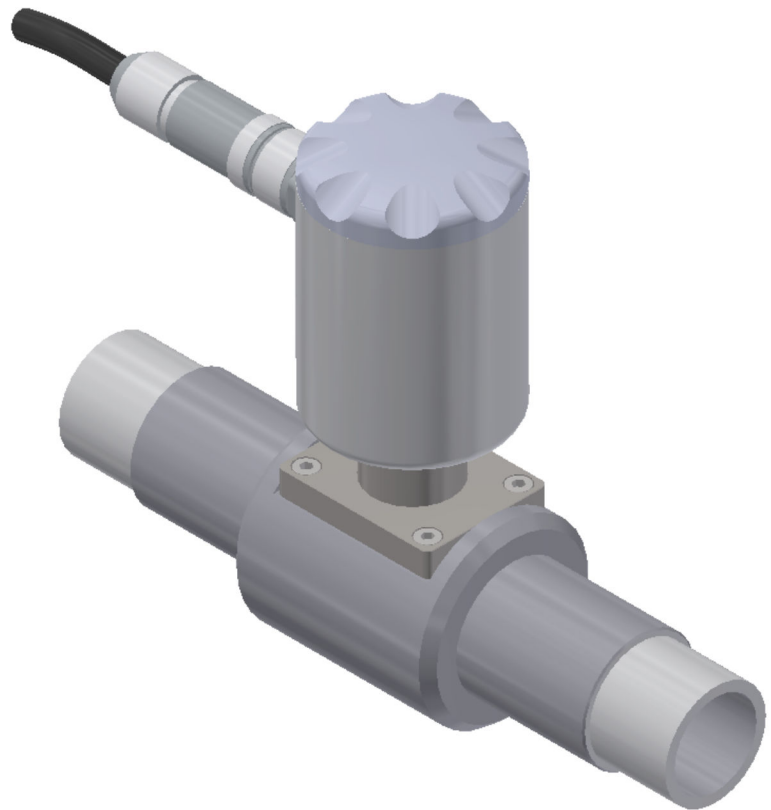

This operating manual is valid for the magnetic-inductive flow sensor PF55S.



## 2 Safety and responsibility

This section provides an overview of all important safety aspects for the protection of people and for safe and failure-free operation. Other task-related safety guidelines are included in the sections on individual life phases.

### 2.1 Symbols in this manual

#### Safety guidelines

Safety guidelines in this manual are identified by symbols. The safety guidelines are introduced by signal words, which convey the extent of the hazard.



#### **DANGER!**

This combination of symbols and signal words indicates an immediate dangerous situation that causes death or serious injuries if not avoided.



#### **WARNING!**

This combination of symbols and signal words indicates a potentially dangerous situation that can result in death or serious injuries if not avoided.



#### **CAUTION!**

This combination of symbols and signal words indicates a potentially dangerous situation that can result in minor or slight injuries if not avoided.



#### **NOTICE!**

This combination of symbols and signal words indicates a potentially dangerous situation that can result in material damage if not avoided.



#### **ENVIRONMENT!**

This combination of symbols and signal words indicates a potentially dangerous situation that can result in environmental damage if not avoided.

#### Safety guidelines in the instructions

Safety guidelines may relate to particular, individual instructions. Such safety guidelines are embedded within the instructions so that they do not interrupt the reading flow when performing operations. The signal words described above are used.

Example:



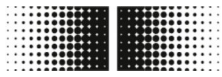

1.  Loosen the screw.

2. 



**CAUTION!**  
Risk of getting caught in the lid!

Close the lid carefully.

3.  Tighten the screw.

### Special safety instructions

The following symbols are used in the safety instructions in order to draw attention to specific hazards:

Warning signs	Type of danger
	Warning – dangerous electrical voltage.
	Warning – danger zone.





### Tips and recommendations



*This symbol highlights useful tips and recommendations, as well as information for efficient and error-free operation.*

### Other labels

The following labels are used to highlight instructions, results, lists, references and other elements in this manual:

Marking	Explanation
	Step by step handling instructions
	Results of steps
	References to sections of this manual and other applicable documents
	Lists without a specified order
<i>[Enter]</i>	Screen elements (e.g. switch areas, layout of function buttons) Operating elements (e.g. buttons, switches)
<i>Display</i>	Screen elements (e.g. menu titles, window descriptions)
<i>Function</i>	Screen elements (e.g. Interface texts)

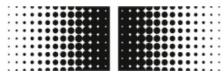

## 2.2 Designated use

The flow sensor PF55S is exclusively intended for use in confined spaces within industrial working environments.

Proper application also includes adherence to all information given in this manual. This relates in particular to adherence to the technical information.

The flow sensor measures and detects the flow rates of fluids.

This Fflow sensor complies with the Pressure Equipment Directive (PED) and is designed and manufactured as per the state of the art for media in fluid group 2.

The application range includes conductible fluids with the following properties:

- Conductibility  $\geq 50 \mu\text{S}/\text{cm}$
- Viscosity  $< 70 \text{ mm}^2/\text{s}$  at  $40 \text{ }^\circ\text{C}$  ( $< 70 \text{ cST}$  at  $104 \text{ }^\circ\text{F}$ )

Components can be assembled differently within a system. Please note that technical limitations are defined by the limitations of the weakest component of the system.

## 2.3 Reasonably foreseeable misuse

Misuse especially includes the following:

- Any use of the flow sensor beyond the intended use or any other improper use.
- Any use of the flow sensor by unqualified or incorrectly qualified personnel.
- Use of the flow sensor together with accessories not approved by Baumer.
- Use of the flow sensor in potentially explosive atmospheres.

## 2.4 Work areas and danger zones

The work areas and danger zones depend on the layout of the sensor PF55S of the higher-level production equipment and the prevailing circumstances at the installation site. They must therefore be determined by the operating company.



### **DANGER!**

**Non-observance of operating company's obligations could result in serious injuries or death.**

- Always ensure adherence to the operating company's obligations.

↪ 2.7 "Responsibility of the owner" on page 11

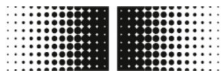

## 2.5 Safety marking

Symbols and information signs can be found on the sensor PF55S or in the working range. They refer to the immediate surroundings in which they are mounted.



### **WARNING!**

#### **Danger due to illegible signage**

Over time, stickers and signs may become dirty or otherwise unrecognizable, meaning that the dangers are not recognized, and necessary operating instructions cannot be followed. This can lead to injury.

- All safety instructions, warnings and operating instructions must be easily legible at all times.
- Damaged signs or stickers must be replaced immediately.



### **DANGER!**

#### **Danger if the safety markings are missing or are not understandable**

Observe the component-specific safety information.

## 2.6 Securing against restart

When working on live components, you must ensure that they cannot be restarted unintentionally. A system is secured against unintentional restart when the power supply is switched off and the main switch is secured with a lock.

If it is not possible to secure the main switch from being switched on with a lock, the mains plug must be removed from the socket and secured.

## 2.7 Responsibility of the owner

### **Owner**

The owner is the person who operates or owns the sensor PF55S, or who has assumed the decisive economic authority over the technical operation of the equipment. Normally, the owner is not Baumer, but rather the purchaser of the sensor PF55S.

### **Operating company's obligations**

The PF55S is used in the commercial sector. The PF55S owner is therefore subject to the legal obligations concerning occupational safety.

In addition to the safety instructions in this manual, the safety, occupational health and safety and environmental protection regulations applicable to the field of application of the system must also be complied with.

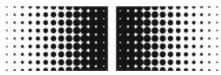

The following, in particular, applies:

- The operating company must be familiar with the applicable health and safety regulations and must compile a risk assessment to identify additional hazards that arise due to the specific working conditions at the PF55S installation site. The owner must implement this in the form of operating instructions for using the PF55S.
- The operating company must define the work areas and danger zones.
- The operating company must define a procedure for preventing the higher-level production equipment from being turned on unintentionally. The description in this manual refers to the sensor PF55S only.
- The operating company must request and regularly evaluate and update the safety data sheets for the operations and process equipment used. He must produce operating instructions for handling the operations and process equipment safely.
- Throughout the entire operating life of the PF55S, the operating company must check whether the operating instructions he created correspond with the latest regulations and must adjust them as necessary.
- The owner must clearly regulate and specify in writing the responsibilities for installation, operation, troubleshooting, maintenance and cleaning.
- The operating company must ensure that all persons handling the PF55S have read and understood this manual. Furthermore, he must also train the personnel and inform them about the dangers at regular intervals. This training must be documented.
- The operating company must provide personnel with the necessary protective equipment and instruct them of their obligation to wear the necessary protective equipment.

Furthermore, the operating company is responsible for permanently maintaining the sensor PF55S and other components of the production system in a perfect technical condition. The following therefore applies:

- The operating company must ensure that the service intervals described in this manual are adhered to.
- The operating company must carry out checks at regular intervals, or at least following any maintenance work, to ensure that the safety devices of all components of the production system are functional.
- In the event of errors or irregular system behavior, the operating company must ensure that operation is stopped immediately, the cause is identified, and that the error is resolved before operation is resumed.
- The operating company must ensure that it is always possible to disconnect the sensor PF55S power and compressed air system during maintenance and repair works.

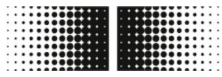

### 2.8 Integrator responsibilities

#### Integrator

The integrator is the person responsible for installing the sensor PF55S within the higher-level machine.

The integrator can be a machine manufacturer, an engineering office, Baumer hhs or the operating company.

The integrator is to review and appropriately adapt the following features and equipment:

- Safety features
- Protection equipment
- Controller interfaces
- Connections to the control system

#### Integrator tasks

The sensor PF55S is typically installed within a higher-level machine. This installation creates new interfaces, which can lead to additional hazards.

The following critical areas can result from this:

- The installation environment for the sensor PF55S in the higher-level machine may differ from the originally intended installation environment.  
Example: The sensor could be subjected to a strong electromagnetic field that generates a fault beyond the industry standard measure.
- The operating company's desired installation position for the sensor PF55S in the higher-level machine could differ from the Baumer assumed installation conditions.  
Example: The operator may not be able to use the sensor without risk because of a conveying element in the higher-level machine.
- The protective measures intended by Baumer may no longer be sufficient or may have to be removed a result of the installation conditions.  
Example: Safety devices may have to be removed to increase the installation space for the sensor.
- Warnings may be concealed by machine parts and therefore not be legible.

This results in the following tasks for the integrator:



- The integrator must conduct a risk assessment that covers the following areas:
  - Installation of the sensor PF55S in the higher-level machine and any associated interface resulting from this.
  - Any change to the protection measures required due to installation of the sensor PF55S in the higher-level machines.
  - Any change in the use of the machine.
- The integrator must eliminate any hazards identified in the risk assessment or mitigate the risk associated with such hazards by means of the following hierarchically ordered protection measures:
  - Eliminate the hazards through design.
  - Minimize the risk through design requirements and definition of the hazard zones.
  - Minimize the risk through technical protection measures and supplementary measures. Adapt the effective range of the control system where appropriate.
  - Mitigate the risk through user information.
- The integrator must instruct the operating company with respect to these measures and any remaining residual risks. The technical documentation must be augmented where appropriate.

## 2.9 Immediate measures following an accident

The machine and its environment are so designed that as far as humanly possible accidents can be precluded if:

- All safety devices are active.
- There is compliance with all safety regulations.
- All specified maintenance and repair work is carried out.

Despite all these measures, accidents cannot be excluded in practice. An accident is never planned. The cause is mostly misconduct (foolhardiness, overconfidence or hectic pace) of the individuals concerned. Defective components attributed to poor maintenance can also be the cause.

In everyday life, the cause of an accident is often a combination of different circumstances. This makes it virtually impossible to produce a detailed procedural instruction for the accident report. All measures after an accident must be dealt with attentively and with the necessary expertise, otherwise an increase in the damages or loss is to be expected.

### Measures required after an injury

In general it is impossible to preclude any type of injury. All imaginable combinations are possible. It is therefore not possible to make a sweeping statement on the measures required.

### Recommendation

Medium and severe injuries must be treated by doctors. Initial treatment (First Aid measures) by medics or by trained first responders is useful and necessary.

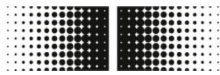

For the event of contact with various chemicals and processed material it is advisable to:

- Manufacturer's data sheets:
  - Follow them and keep them ready to hand.
  - Always provide them to the doctor if one is called.
- After inhalation:
  - Go into the fresh air.
  - Visit a doctor in the event of persistent complaints.
- If skin comes into contact with **hot** material:
  - Do not remove material from your skin!
  - Rinse with plenty of water, if possible.
  - Remove contaminated clothing.
- After burns:
  - Cool immediately.
- If skin comes into contact with **cold** material:
  - Rinse with plenty of soap and water.
  - Remove contaminated clothing.
- After eye contact:
  - Rinse with plenty of water for around 10 – 15 minutes. Hold your eyelids open. Remove contact lenses if you wear them.
- If swallowed:
  - Rinse your mouth thoroughly with water. Where appropriate drink 1 – 2 glasses of water. Do not induce vomiting.

In any case, see a doctor as soon as possible.

Have even what appear to be minor injuries examined and treated by specialists. Apparently insignificant injuries, where liquids such as adhesives, hydraulic or lubricating oils, emulsions or other chemical substances could have entered the wound, can lead to severe consequential damages. They can cause life-threatening circulatory disorders, infections and poisoning.

### Immediate measures following an electrical accident

An electrical accident is the result of a human body closing the circuit between two energized parts.

In the event of an electrical accident the threat to individuals depends on the following parameters:

- Current path
- Contact voltage
- Duration of the current flow
- Frequency
- Level of moisture of the skin
- Size of the contact surface

It can include heart rhythm disturbances, ventricular fibrillation and burn injuries due to the arcing effect. It is always advisable to consult a doctor.

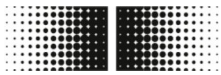

### ***Intrinsic safety in an electrical accident***

*The intrinsic safety of the rescuer has absolute priority in the event of an electrical accident.*

The power must be disconnected in **low voltage accidents** by following measures:

- Switching off
- Pulling the plug
- Removing the fuse
- Turning off the main switch

Firstly separate the injured party from the power source using non-conductive items and only then rescue them from the hazard zone.

No rescue attempts should be undertaken in **high voltage accidents** because of the intrinsic risk. In the event of high voltage accidents always immediately initiate the emergency call and summon specialist safety personnel.

The safety personnel must undertake clearing and securing according to the five safety rules:

- Summon qualified electrical staff (for shutdown)
- Maintain the safety clearance (at least 5m in the case of high voltage)
- Switch off the electrical circuit
- Secure it against being switched on again
- Have a qualified electrician determine voltage free status
- Have energized parts nearby covered or isolated by a qualified electrician
- Assistance only in consultation with a qualified electrician

## 2.10 Personnel requirements



### **WARNING!**

#### **Risk of injury if personnel are insufficiently qualified**

Application of the required specialist knowledge for the PF55S. Inadequate or missing personnel qualification increases the risk of an accident. This can result in severe injuries and substantial property damage.

Hazards arise that can result in serious injuries and considerable material damage if unqualified personnel perform work on the device or are present in the system's hazard zone.

- Have all activities carried out by qualified personnel only.
- Always keep unqualified personnel away from hazard zones.



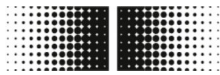

Only persons 18 years of age or above, who can therefore be expected to carry out their work dependably, are permitted as personnel. Personnel must have carefully read through and understood this manual before starting any work. Following all safety guidelines and instructions in this manual is the basic prerequisite for safe work.

Persons whose reactions are affected, e.g. by drugs, alcohol or other medication, are not permitted.

Observe the age and occupation-specific regulations applicable to the installation site when selecting personnel.

This manual distinguishes between the personnel qualifications listed below for the different fields of activity:

### **Operator**

In training by the owner, the operator has been informed of the tasks assigned to him and the possible hazards in the event of improper conduct. Tasks beyond operation in the regular operating mode may only be carried out by the operator if this is indicated in this manual and the owner has explicitly entrusted the operator with the task.

### **Qualified electrician**

Due to his technical training, knowledge and experience, as well as his understanding of the relevant standards and regulations, a qualified electrician is able to carry out work on electrical systems, and identify and avoid possible hazards independently.

A qualified electrician has been specially trained in the working environment in which he operates and knows the relevant standards and regulations.

### **Qualified mechanic**

Due to his technical training, knowledge and experience, as well as his understanding of the relevant standards and regulations, a qualified mechanic is able to carry out work on mechanical systems, and identify and avoid possible hazards independently.

A qualified mechanic has been specially trained in the working environment in which he operates and knows the relevant standards and regulations. A qualified mechanic is also familiar with the superordinate production system.

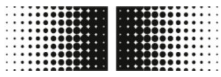

## Unauthorized persons



### WARNING!

#### Risk of death for unauthorized persons in the danger zones and work areas

There are hazards in the working range that only qualified personnel can safely assess and avert. Those who are unauthorized and do not comply with the described requirements face the risk of severe injuries and even death.

- Always keep unauthorized individuals away from the danger zone and work area.
- If in doubt, address people and direct them out of the danger zone or work area.
- Always interrupt work as long as unauthorized individuals are in the danger zone or work area.

## Training

The owner must train personnel regularly. Training takes place annually for safety-relevant aspects. For improved monitoring, a training record with the following minimum content must be created:

- Date of training
- Name of trainee
- Training content
- Name of trainer
- Signatures of the trainee and trainer

## 2.11 Personal protective equipment

### Description of personal protective equipment

Personal protective equipment serves to protect people from impairments to health and safety during work.

During different types of work on and with the PF55S, personnel must wear the personal protective equipment specifically referred to in the individual sections of this manual.



#### Protective work clothing

Protective work clothing is defined as close fitting work clothing with low tear resistance, tight, long sleeves and no protruding parts.



#### Safety boots

Safety boots protect feet from being crushed, from falling parts and from slipping on slippery surfaces.

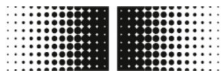

## 2.12 Safety guidelines for transport and storage



**WARNING!**

**Risk of injury to the musculoskeletal system**

The weight of the package can be found on the consignment note or printed on the packaging.

Use suitable transport and lifting aids for weights over 25 kg.

### Improper transport



**NOTICE!**

**Material damage due to improper transport**

Packages may fall or topple over due to improper transport. This can result in considerable material damage.

- Proceed with care when unloading transport items upon delivery and during internal transport.
- Follow the symbols and information on the packaging.
- Do not remove packaging until shortly before assembly.

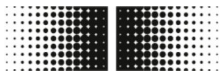

## 2.13 Safety guidelines for assembly and commissioning

### Improper assembly and installation



#### **WARNING!**

#### **Risk of injury due to improper assembly and installation**

Improper assembly or installation can result in hazardous situations, causing serious injuries and considerable property damage.

- Have assembly and installation work carried out by authorized specialist personnel only.  
↳ 2.10 “Personnel requirements” on page 16
- Ensure the following if assembly and installation are to be carried out by other persons:
  - The individuals must have read and understood this operating manual.
  - The individuals must follow the instructions in this operating manual.
  - The individuals must have the necessary specialist skills for such assembly and installation.
- If assembly and installation are to be carried out by internal personnel, or by personnel contracted by the operating company, the operating company is responsible for ensuring the assembly and installation are carried out correctly and safely.
- Always ensure sufficient space for assembly before beginning work.
- Always make sure that the assembly site is clean and tidy. Loose components and tools lying around or on top of each other are sources of accidents.
- Always determine installation locations to account for hazard-free access and operation.
- Assemble all of the components correctly.
- Always follow the operation and assembly manuals for additional components.

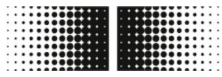

## Improper commissioning



### **WARNING!**

#### **Risk of injury due to improper commissioning**

Improper commissioning can result in serious injuries and considerable material damage.

- Always ensure, before commissioning, that all installation work has been carried out and completed in accordance with the information and instructions set out in this manual and the associated circuit diagrams.
- Always ensure, before commissioning, that all safety equipment is functioning correctly.
- Always ensure that nobody is in the hazard zone before commencing commissioning.
- Commissioning should be carried out only by authorized and trained personnel.

If commissioning is to be carried out by other persons ensure the following:

- The individuals must have read and understood this operating manual.
- The individuals must follow the instructions in this operating manual.
- The individuals must have the necessary specialist skills for such assembly and installation.

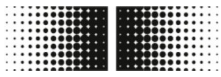

## Electrical connection



### **DANGER!**

#### **Risk of death due to electrical current**

Touching live parts poses the risk of immediate death by electric shock. Damage to the insulation or individual components can have fatal consequences.

- Only have work on the electrical system carried out by electricians.
- In the event of damage to the power cable, immediately switch off the power supply and replace the cable.
- Only connect the power cable to sockets with a protective earth conductor.
- Always keep heat sources away from power cables.
- Only ever use a mains connection protected by a fuse.
- Always attach the connections provided on the component according to current local requirements.
- Always ensure that the connections provided on the component are easily accessible.
- Always before beginning work on active components of electrical systems and equipment, ensure that their power supply has been disconnected and that it remains so for the duration of the work.  
Observe the 5 safety rules:
  - Switch off.
  - Ensure that it cannot be switched back on.
  - Confirm that no voltage is present.
  - Earth and short circuit.
  - Cover neighboring live parts or make them inaccessible.
- Never override or bypass fuses. Maintain the correct current when changing fuses.
- Always keep live parts free of moisture. This can cause a short circuit.

## Contamination



### **NOTICE!**

#### **Risk of material damage due to contamination**

Contamination can cause material damage by affecting system components.

- Always cover at-risk parts of the equipment before work such as drilling.
- Always collect dust and shavings immediately throughout the assembly process.

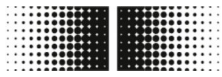

## Tightness of the piping system



### **WARNING!**

#### **Danger due to leaking system**

Leaks in the system may occur when the flow sensor is installed within a piping system. These leaks can lead to a variety of different dangers.

The following must be observed when installing the flow sensor:

- The inner diameter of the seals is always equal to or greater than the inner diameter at the connection of the pipeline.
- Seals must always be checked for damage and cleanliness.
- Seals must always be properly installed.



### **CAUTION!**

#### **Short circuit of the measuring signal due to incorrect sealing compound**

If impermissible sealing compounds are used, an electrically conductive layer can form on the inside of the measuring tube of the sensor. As a result, short circuits of the measuring signal are possible.

- Never use electrically conductive sealing compounds such as graphite.

## 2.14 Safety guidelines for maintenance and resolving faults

### Improper maintenance



### **WARNING!**

#### **Risk of injury due to improper maintenance**

Improper maintenance can result in serious injuries and considerable material damage.

- Always ensure that all previous maintenance work has been carried out and completed in accordance with the information and instructions set out in this manual and the associated circuit diagrams.
- Ensure that nobody is in the hazard zone before commencing maintenance.
- Maintenance must only be carried out by personnel trained and authorized by the owner.
  - Personnel must have read and understood this operating manual.
  - Personnel must follow the instructions in this operating manual.
  - Personnel must have the necessary specialist skills for such maintenance.

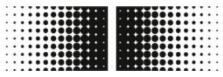

## Improper troubleshooting



### **WARNING!**

#### **Risk of injury due to improper troubleshooting**

Improper troubleshooting can result in serious injuries and considerable material damage.

- Always ensure that all repair work is carried out as per the information and instructions set out in this manual and in the associated circuit diagrams.
- Ensure that nobody is in the hazard zone before commencing troubleshooting.
- Troubleshooting must only be carried out by personnel trained and authorized by the owner.
  - Personnel must have read and understood this operating manual.
  - Personnel must follow the instructions in this operating manual.
  - Personnel must have the necessary specialist skills for such troubleshooting.



### **NOTICE!**

#### **Property damage due to improper cleaning**

Unsuitable cleaning agents and methods can result in leaks on the flow sensor, at the seals or connections and thus in property damage.

- Always use a cleaning agent with a flash point above 55 °C.
- Always check that the cleaning agent is suitable for cleaning the surfaces that require cleaning.
- Never use abrasives, solvents or other aggressive cleaning agents for cleaning.
- Never clean using a jet of liquid, e.g. pressure washer.
- Never scratch off dirt using sharp objects.

## 2.15 Safety information for replacement parts

### Using incorrect replacement parts



### **WARNING!**

#### **Risk of injury due to the use of incorrect replacement parts**

Hazards for personnel, as well as damage, malfunctions or a total failure can occur due to the use of incorrect or faulty replacement parts.

- If you have any questions, always contact Baumer.



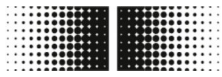

## Warranty



### **Invalidation of the warranty**

*The warranty become null and void if unauthorized replacement parts are used.*

## Acquisition of replacement parts

Replacement parts can be acquired from local contact partners or direct from Baumer at [www.baumer.com](http://www.baumer.com).

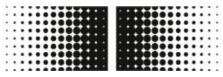

## 3 Layout and functional description

### 3.1 Structure

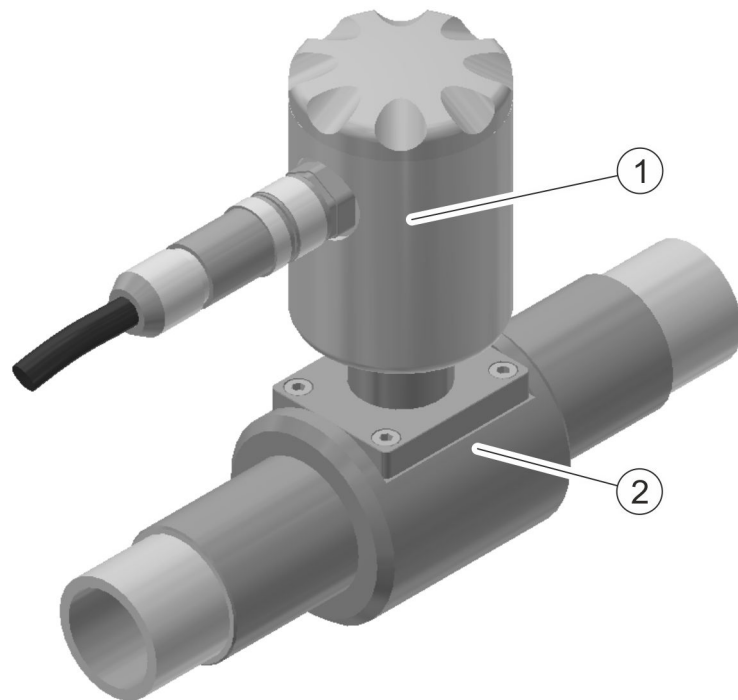

- 1 Transducer
- 2 Sensor

The flow sensor consists of a transmitter and a sensor.

It is available for different pipe diameters:

☞ *“Dimensions for flow sensor with DN 10 to 20” on page 98*

The magnetic-inductive flow sensor's measuring principle is based on Faraday's law of electromagnetic induction.

☞ *“Functional principle” on page 26*

The flow sensor measures the flow volume of fluids with a conductivity of 50  $\mu\text{S}/\text{cm}$  in closed pipes.

### 3.2 Functional description

#### Functional principle

The magnetic-inductive flow sensor's measuring principle is based on Faraday's law of electromagnetic induction.

The coils of the flow sensor generate a magnetic field orthogonal to the flow direction. The charge carriers of a conductive liquid are deflected by Faraday's law of induction when passing through the magnetic field. As a result, an electrical voltage between the measuring electrodes is induced, which is measured and evaluated. The higher the liquid velocity, the higher the induced voltage.

The voltage signal is converted by the integrated electronics of the transmitter based on the nominal size in flow volume.

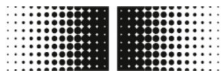

### 3.3 Ports

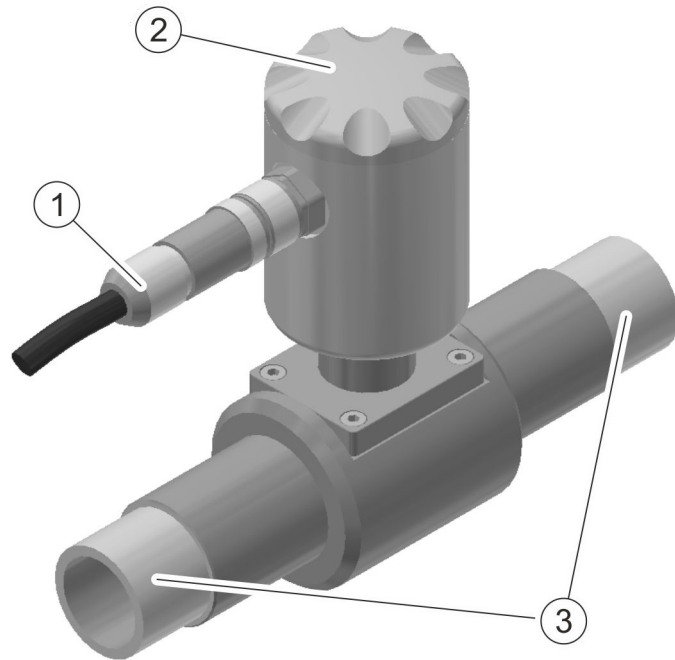

- 1 Electrical connection
- 2 Transducer cover
- 3 Pipe connections

With the electrical connection, the flow sensor is connected to the PLC or the system control cabinet of the higher-level machine.

↳ 5.4 “*Electrical connection*” on page 38

At the pipe connections, the flow sensor is mounted in a piping system.

↳ 5.3 “*Installation*” on page 35

The transmitter cover can be unscrewed. The USB port of the flow sensor for connection to a PC is underneath this cover.

↳ 6.1 “*Create USB interface*” on page 41

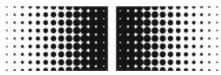

### 3.4 Control software BCP

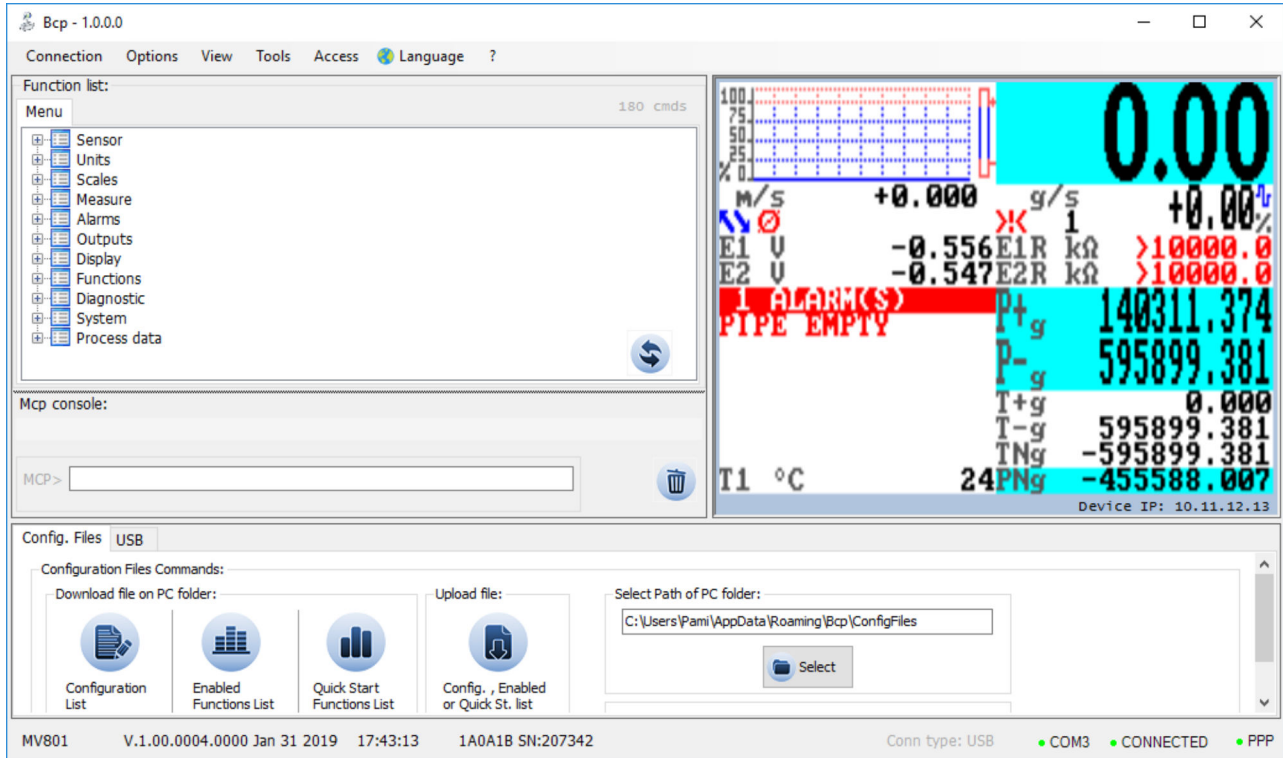

The BCP control software is used to configure and operate the flow sensor.

↪ 7.1 “BCP Software” on page 47

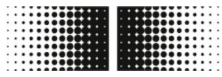

## 4 Transport and storage

### 4.1 Delivery

The packaging protects the individual components against transport damage, corrosion and other damage until installation. For this reason, do not destroy the packaging.

The PF55S is packed in accordance with the expected transport conditions. The packaging size and material can vary depending on the total delivery volume.

### 4.2 Transport inspection

Check the delivery for completeness and for transport damage immediately upon receipt.

In the event of visible external transport damage, proceed as follows:

- Do not accept the or accept the delivery with reservation only.
- Note the extent of the damage on the transport documentation or on the transporter's delivery note.
- Filing a complaint.



*File a complaint for every defect as soon as it is detected. Claims for damage can only be invoked within the statutory reclamation period.*

### 4.3 Storage of packages

#### Storage of packages

Store packages under the following conditions:

- Do not store outdoors.
- Store in a dry dust-free place.
- Do not expose to aggressive media.
- Protect from direct sunlight.
- Avoid mechanical shocks.
- Storage temperature: 15–40 °C.
- Relative humidity, maximum 80 %, non-condensing
- If storing for a period of more than 3 months, check the general condition of all parts and the packaging regularly.

### 4.4 Disposing of packaging materials

Dispose of packaging materials in accordance with the respective applicable provisions and local regulations.

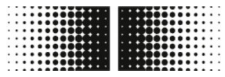

### **ENVIRONMENT!**

#### **Risk to the environment due to incorrect disposal**

Packaging materials are valuable raw materials and, in many cases, can continue to be used or sensibly reprocessed and sustainably reused. The incorrect disposal of packaging materials can result in risks to the environment.

- Always dispose of the packaging materials in an eco-friendly manner.
- Always observe the locally applicable disposal regulations. Instruct a specialist company to undertake disposal, if necessary.

The recipient is responsible for any costs associated with the disposal.

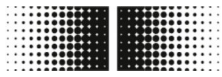

## 5 Assembly and installation

Ensure the following prior to installation of the flow sensor:

- The higher-level machine is in a safe state for the installation of the flow sensor.  
↳ 5.1 “Prerequisites for installation” on page 31
- The installation position of the flow sensor has been selected according to the criteria of the system and the requirements of the flow sensor.  
↳ 5.2 “Installation position of the flow sensor” on page 32

### 5.1 Prerequisites for installation

When installing the flow sensor in the higher-level machine, the following must be observed for the mounting location:

- The flow sensor must not be exposed to excessive vibration at the installation site.
- The flow sensor must not be overly dirty at the installation site.
- The flow sensor must be protected from direct sunlight at the installation site.
- The installation site must allow proper grounding of the flow sensor.
- The installation site must allow the proper electrical connection of the flow sensor.
- The flow sensor must be freely accessible at the installation site at all times.
- Mechanical effects on the flow sensor must be excluded during operation.
- During installation, the recommended and avoidable installation positions of the flow sensor must be observed:  
↳ 5.2 “Installation position of the flow sensor” on page 32

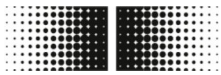

### 5.2 Installation position of the flow sensor

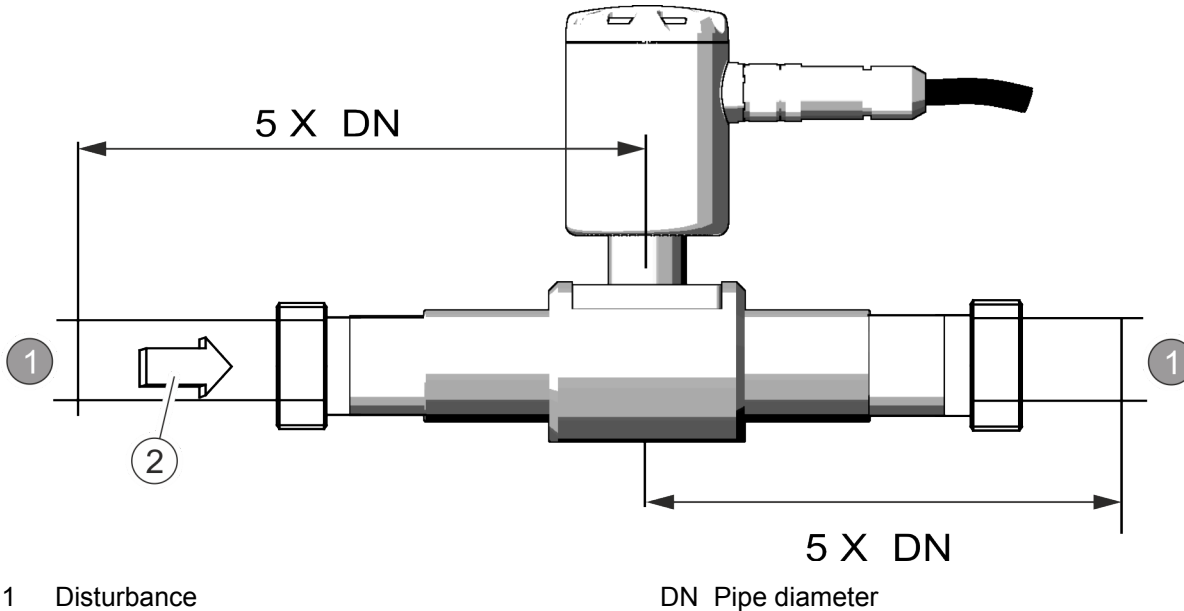

Inlet and outlet sections are to be provided when the flow sensor is installed within a piping system. These provide compensation for disturbance due to curvatures, valves, pumps, reducers and the like.

Shut-off and control devices should never be positioned directly ahead of the flow sensor.

Before installing the flow sensor, the flow direction at the installation point must be determined. The flow direction through the flow sensor is marked on the type plate. The flow direction is defined as follows:

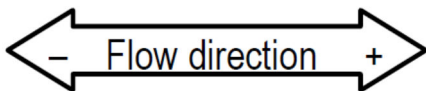

Fig. 1: Identification of the flow direction

Flow direction positive	from - to +
Flow direction negative	from + to -



#### **Change of flow direction**

If the flow direction changes due to the system, the flow sensor does not have to be dismantled.

Only the signs for the KA parameters in the control software have to be changed.

↳ 7.6.1 "Sensor menu" on page 60

#### **Recommended installation position**

Always bear the following in mind when choosing the installation position of the flow sensor:



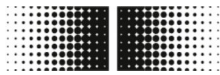

The flow sensor must be installed so that the measuring tube is always completely filled.

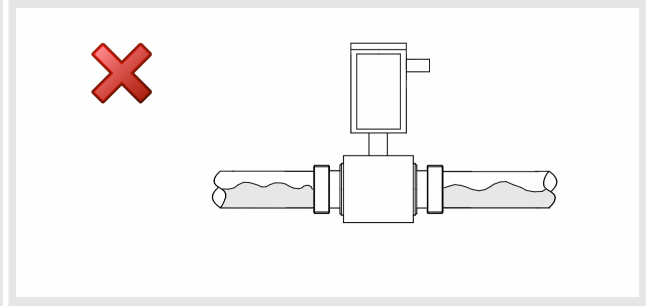
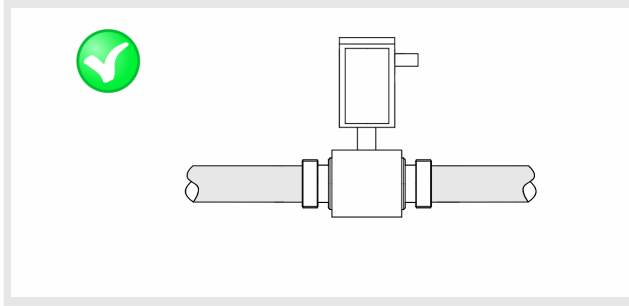

When installing the flow sensor vertically, installation in a rising pipe is preferable.  
Consultation may be required prior to installation in a falling line.

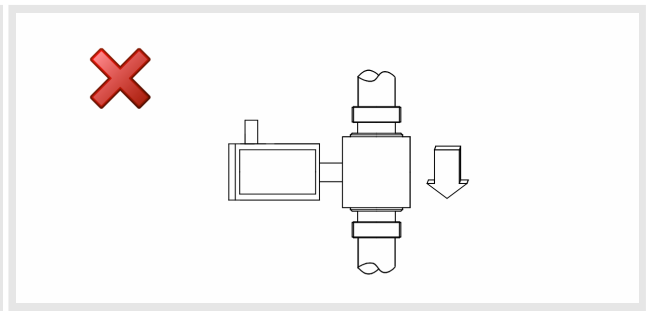
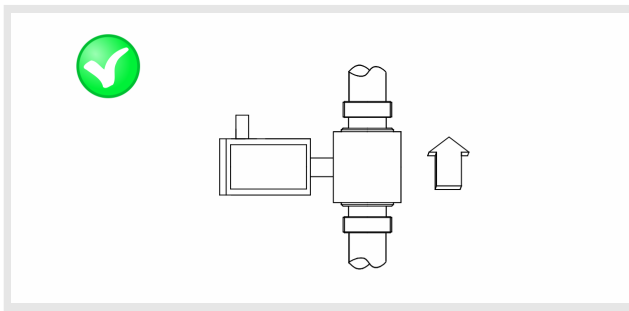

When installing the flow sensor in long lines, anti-vibration compensators should be used.

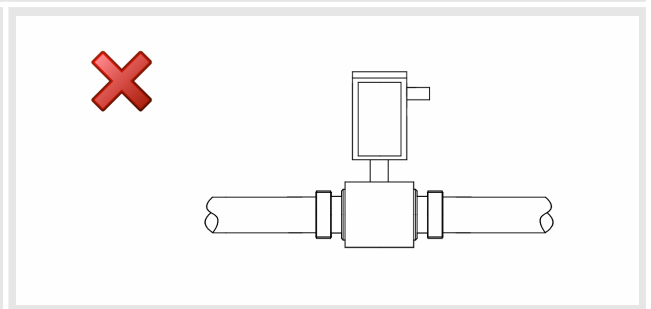
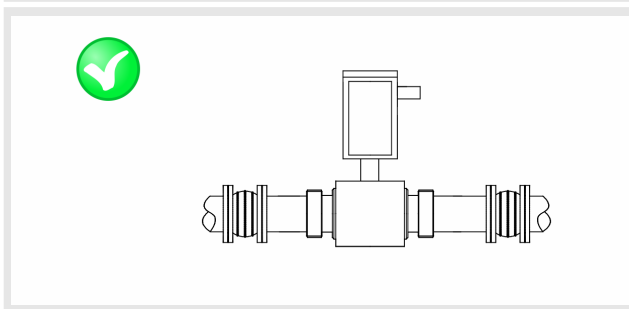

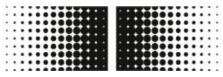

When installing the flow sensor before or after bends, valves, reducers and the like, the inlet and outlet sections must be observed.

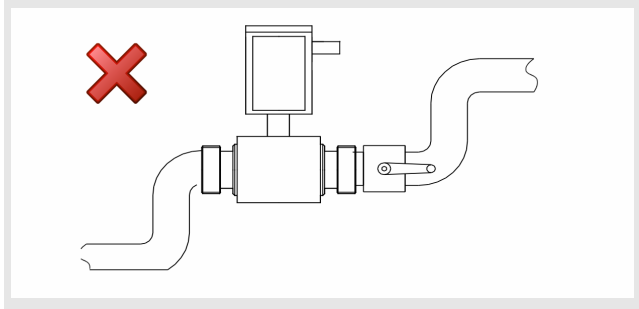
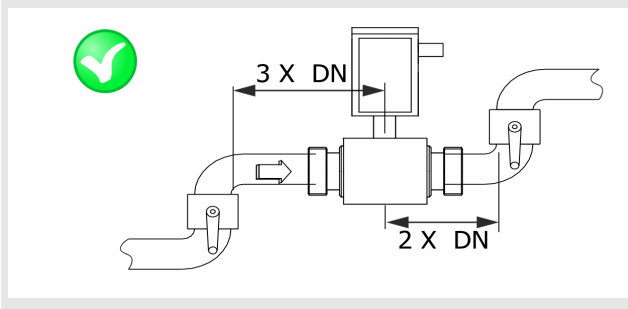

The flow sensor must not be connected to other fittings by tightening clamps.

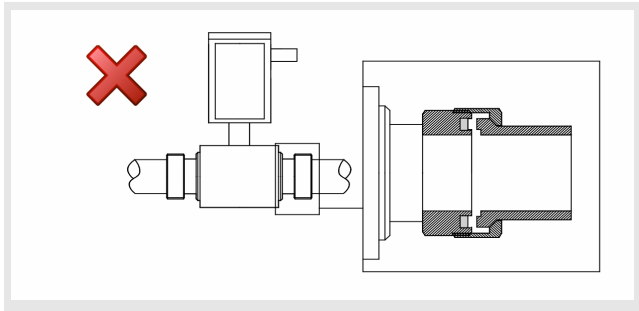
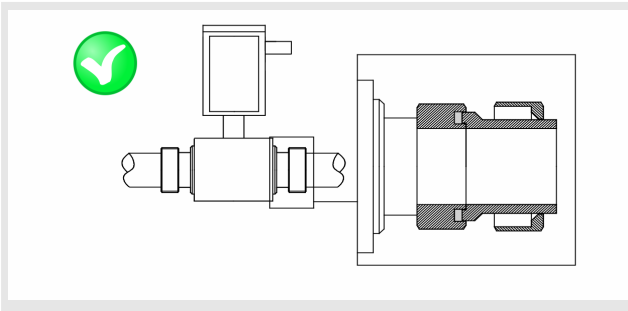

### Installation positions to be avoided

The following installation positions must be avoided:

No installation directly in front of a falling line.

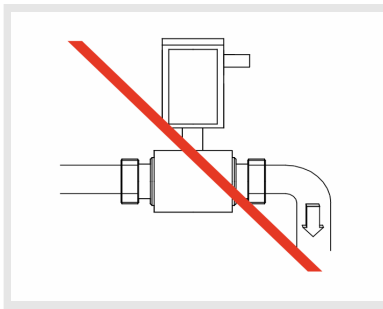

No installation in a falling line.

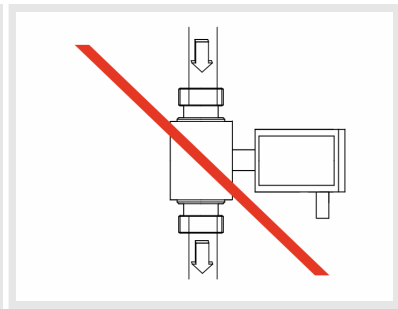

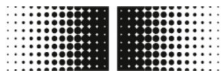

No installation directly in front of a pipe spout.

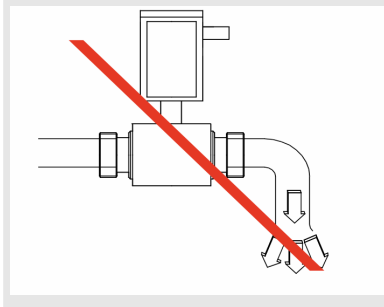

No installation on the suction side of a pump.

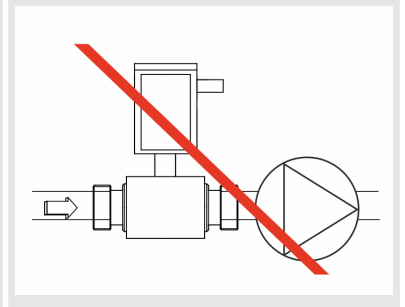

No installation at the highest point of a piping system.

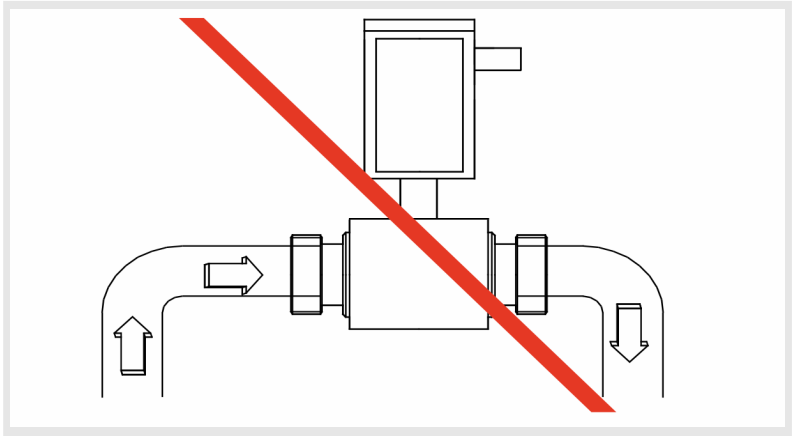

### 5.3 Installation

- Personnel: ■ Qualified mechanic
- Protective equipment: ■ Protective work clothing  
■ Safety boots



#### **DANGER!**

**Risk of injury when entering the operating space of the super-ordinate machine and its moving parts**



#### **CAUTION!**

**Risk of injury due to improper assembly and installation**

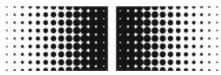

### NOTICE!

**Risk of damage to the equipment due to contamination**

Observe the dimension sheet when installing the flow sensor:

- For flow sensor with DN 10 to 20
  - ↳ *“Dimensions for flow sensor with DN 10 to 20” on page 98*
- For flow sensor with DN 25 to 50
  - ↳ *“Dimensions for flow sensor with DN 25 to 50” on page 99*

**1.** ▶ Choose a suitable place for installing the flow sensor.

Please note the following requirements for installation:

↳ 5.1 *“Prerequisites for installation” on page 31*

**2.** ▶ Make sure that the pipelines are depressurized.

**3.** ▶ Make sure that no media can escape at the installation site.

**4.** ▶ Prepare the installation site on the pipeline system for installation of the flow sensor.

Pay attention to the following:

- There must be enough space for the flow sensor and the infeed and outfeed sections at the installation site of the sensor.
- The required seals and flanges must be present.
- Any necessary transition pieces and fittings must also be present.
- All connections must be clean.

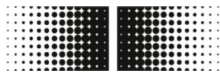

### **WARNING!**

#### **Danger due to leaking system**

Leaks in the system may occur when the flow sensor is installed within a piping system. These leaks can lead to a variety of different dangers.

The following must be observed when installing the flow sensor:

- The inner diameter of the seals is always equal to or greater than the inner diameter at the connection of the pipeline.
- Seals must always be checked for damage and cleanliness.
- Seals must always be properly installed.



### **CAUTION!**

#### **Short circuit of the measuring signal due to incorrect sealing compound**

If impermissible sealing compounds are used, an electrically conductive layer can form on the inside of the measuring tube of the sensor. As a result, short circuits of the measuring signal are possible.

- Never use electrically conductive sealing compounds such as graphite.

#### **5.** ➤ Install the flow sensor in the intended position.

Pay attention to the following:

- Only approved installation tools may be used for the flanges and process connections.
- All transition pieces, fittings and the like must be firmly connected and sealed.
- Only suitable and approved lubricating pastes or sealing compounds may be used.
- The flow sensor must be installed in the correct flow direction.
- The sensor must be firmly and securely installed in the pipeline with seals.
- All torques must be observed during assembly.

#### **6.** ➤ Check the piping system for leaks in the area of the flow sensor.

#### **7.** ➤ Connect the flow sensor electrically.

↳ 5.4 “*Electrical connection*” on page 38

⇒ The flow sensor PF55S is installed.

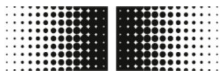

### 5.4 Electrical connection

Electrical pin assignment with cable connection

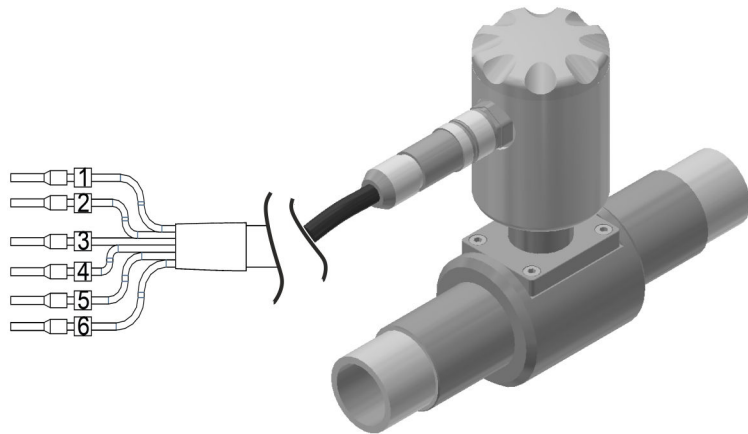

Pin	Assignment
1	Power supply
2	Output 1
3	Output 2 (optional)
4	4 - 20 mA maximum load: 500 Ω output (optional)
5	Power supply outputs
6	Shielding

**PIN 5/6 must be used to establish the grounding connection**

Electrical pin assignment with plug-in connection (M12)

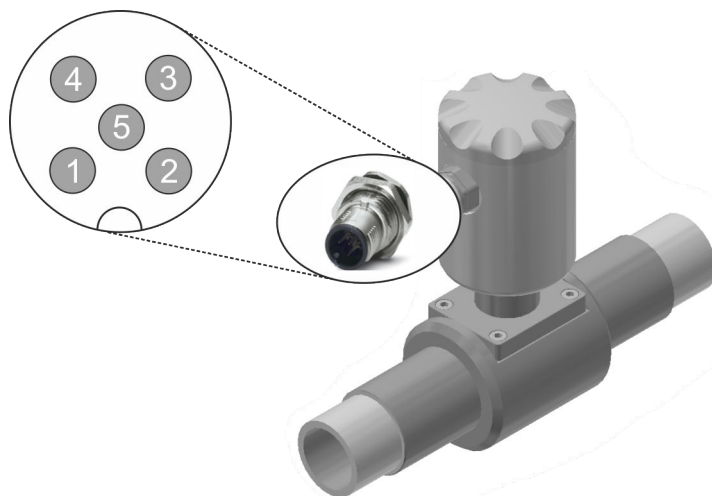

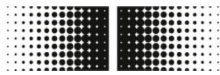

Pin (M12)	Assignment
1	Power supply
2	Output 1
3	Output 2 (optional)
4	4 - 20 mA maximum load: 500 $\Omega$ output (optional)
5	Power supply outputs

**PIN 5 must be used to establish the grounding connection**

- Personnel: ■ Qualified electrician
- Protective equipment: ■ Protective work clothing  
■ Safety boots



### DANGER!

Risk of injury when entering the operating space of the super-ordinate machine and its moving parts



### CAUTION!

Risk of injury due to improper assembly and installation



### WARNING!

Risk of personal injury or property damage due electric current

Ensure the following before electrical connection:

- The mains voltage is within the permissible limits of the flow sensor (see technical data or type plate).
  - The power supply is fitted with overload protection.
  - Only approved cables with fire protection properties are used for the connections.
  - All long or hanging cables are secured with an approved mounting system.
  - All electrical connections are clean.
- 1.** ➤ Ensure the higher-level machine is securely switched off with the power disconnected.
- Disconnect the higher-level machine from the mains if necessary and ensure it cannot be switched back on unintentionally.

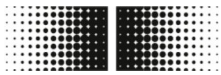

### Follow the circuit diagram

Please refer to the wiring and circuit diagrams for electrical connection.

**2.** → Connect the flow sensor with the plug to the system control cabinet.

⇒ The flow sensor has been electrically connected.

### Connection diagrams

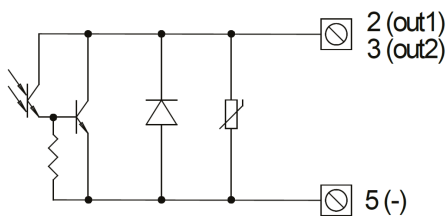

Fig. 2: On/Off outputs

- Optoisolated output
- Maximum switching voltage: 40 V<sub>DC</sub>
- Maximum switching current: 100 mA
- Maximum saturation voltage between collector and emitter at 100 mA: 1.2 V
- Maximum switch frequency (load of the collector or emitter, R<sub>L</sub> = 470, V<sub>OUT</sub> = 24V<sub>DC</sub>): 1250 Hz
- Maximum reverse current that can be sustained at the input during and in case of accidental polarity reversal (VEC): 100 mA
- Isolation of other secondary circuits: 500 V<sub>DC</sub>
- Maximum load at 30 V: 500 Ω
- Update frequency corresponds to the sampling frequency
- Protected against permanent overvoltages up to 30 V<sub>DC</sub>

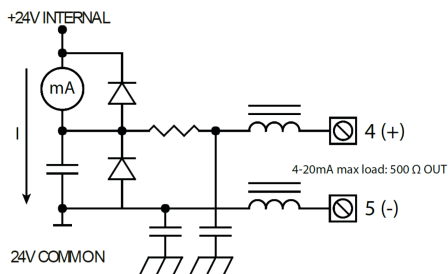
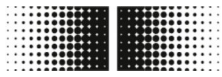

Fig. 3: Output 4





## 6 Commissioning



*In certain countries and regions, inspections are carried out or authorization obtained before commissioning the equipment.*

The flow sensor can only be operated as a component within an pipeline system. Observe the operating company's specifications and the settings for the overall system, as well as all safety information and descriptions within this manual, during commissioning.

- The flow sensor must be installed.  
↳ 5.3 "Installation" on page 35
- The flow sensor must be electrically connected.  
↳ 5.4 "Electrical connection" on page 38

Before commissioning, all system parameters must be set:

- The flow sensor is connected to a PC via the USB port.  
↳ 6.1 "Create USB interface" on page 41
- The BCP software is installed on the PC with all drivers.  
↳ 6.2 "BCP software installation" on page 42

### 6.1 Create USB interface

- Personnel:                   ■ Operator
- Protective equipment:   ■ Protective work clothing  
                                  ■ Safety boots



#### **DANGER!**

**Risk of injury when entering the operating space of the super-ordinate machine and its moving parts**

The flow sensor must be connected to a PC via the USB port in order to install the BCP software with all drivers.

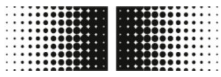

1. ➤ Make sure you have a Type A to B USB cable available for connection.

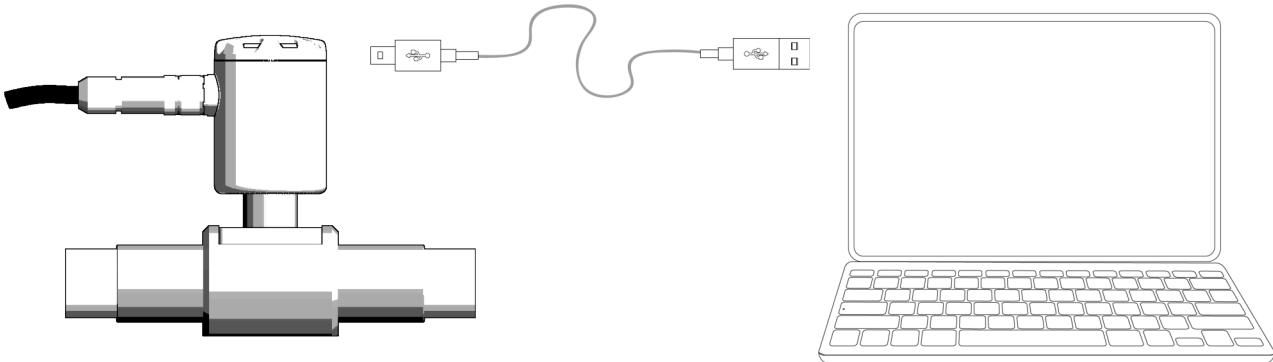

2. ➤ Connect Port A of the USB cable to a free USB port on the PC.
3. ➤ Unscrew the cover at the top of the transmitter of the flow sensor.  
⇒ The USB Port B of the flow sensor is freely accessible.
4. ➤ Connect Port B of the USB cable to the USB port of the flow sensor.  
⇒ The flow sensor is connected to the PC via USB.
  - The BCP software can be installed on the PC with all drivers.  
↳ 6.2 “BCP software installation” on page 42
  - The flow sensor can be configured.  
↳ 7.1 “BCP Software” on page 47

## 6.2 BCP software installation

Personnel: ■ Operator

The flow sensor must be connected to a PC via the USB port.

The PC must have a functioning Internet connection to install the BCP software with all drivers.

↳ 6.1 “Create USB interface” on page 41



### NOTICE!

#### Faulty installation possible due to firewall or virus protection program

The BCP software can be incorrectly recognized or blocked by the firewall or the virus protection program as malware.

In this case, the `BCP.exe` file must be released manually in the firewall or the virus protection program.

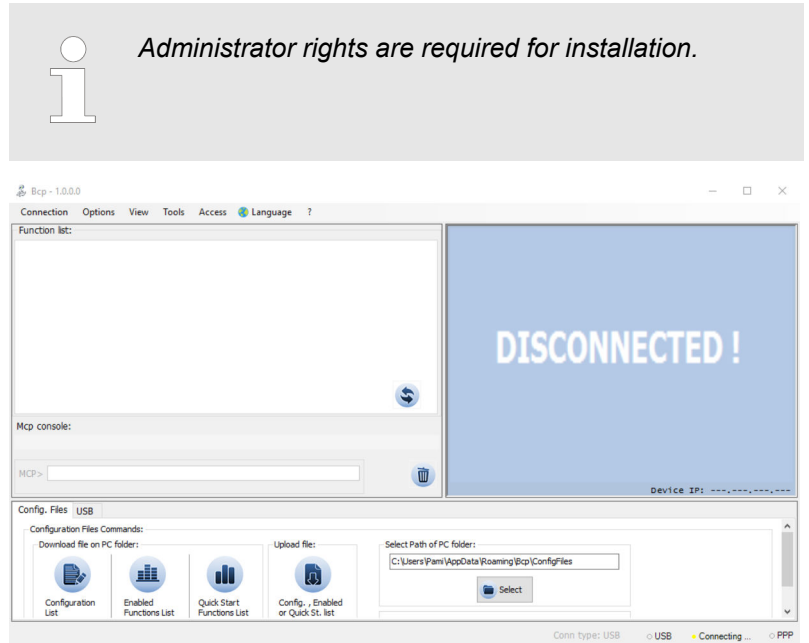
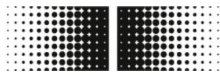

Fig. 4: BCP software start view

1. Download the BCP .exe file to the PC.

The BCP software is available via the product's download area at [www.baumer.com](http://www.baumer.com).

2. Start the BCP .exe file as administrator.

⇒ Two error windows are opened.



*The error windows indicate missing drivers.*

*These drivers are loaded and installed during the installation process.*

*The windows can be closed by pressing the [OK] switch area.*

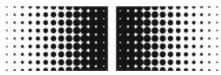

**i** *The first time you install the BCP software, it automatically checks for updates.*

*If necessary, a window opens for updating to the latest version of the BCP software.*

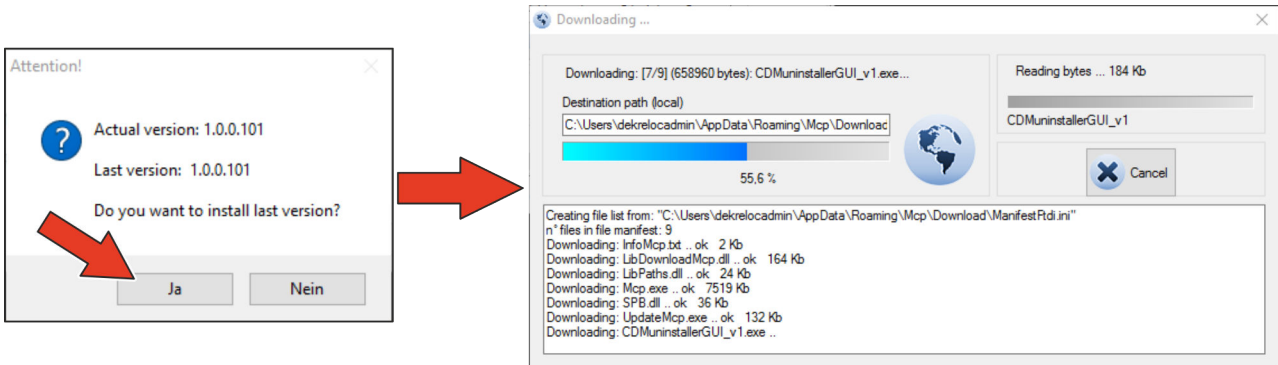

- 3.** ➤ Confirm the automatic update to the latest version by pressing the [YES] switch area.
  - ⇒ The BCP software is automatically updated to the latest version.

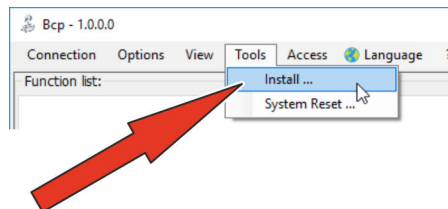

- 4.** ➤ Open the Tools menu.
- 5.** ➤ Open the installation window by selecting the [Install ...] menu option.
  - ⇒ The installation window opens.

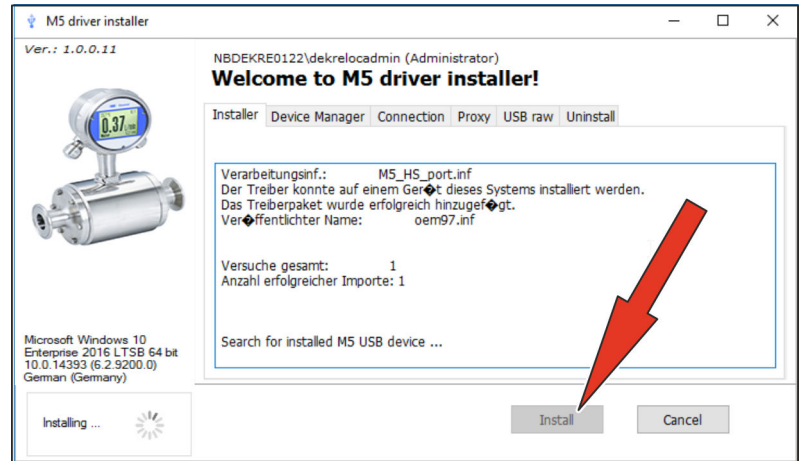
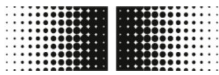

6. → Commence the installation by pressing the *[Install ...]* switch area.

⇒ A confirmation window will open.

7. → Allow the drivers to be installed by pressing the *[Install]* switch area.

⇒ All drivers are installed automatically.



*When the drivers have installed, the USB interface must be disconnected and restored.*

*A window opens with corresponding instructions.*

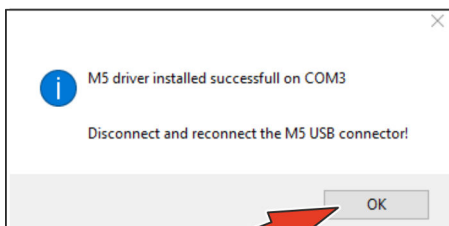
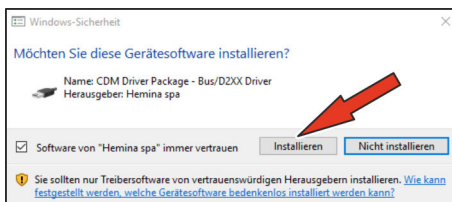

8. → ■ Disconnect the USB interface of the flow sensor from the PC.

■ Restore the USB interface of the flow sensor to the PC.

■ Close the window by pressing the *[OK]* switch area.

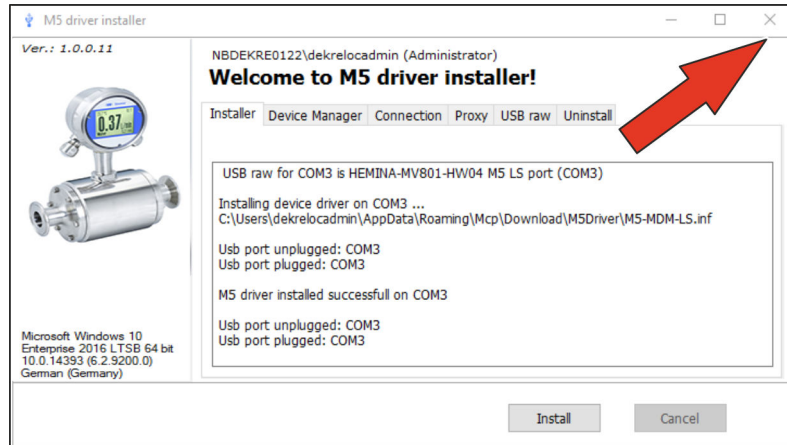
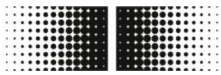

**9.** → Close the installation window by pressing the [X] switch area.

⇒ The BCP software is installed with all drivers.

The flow sensor can be configured.

↪ 7.1 “BCP Software” on page 47



## 7 Operation

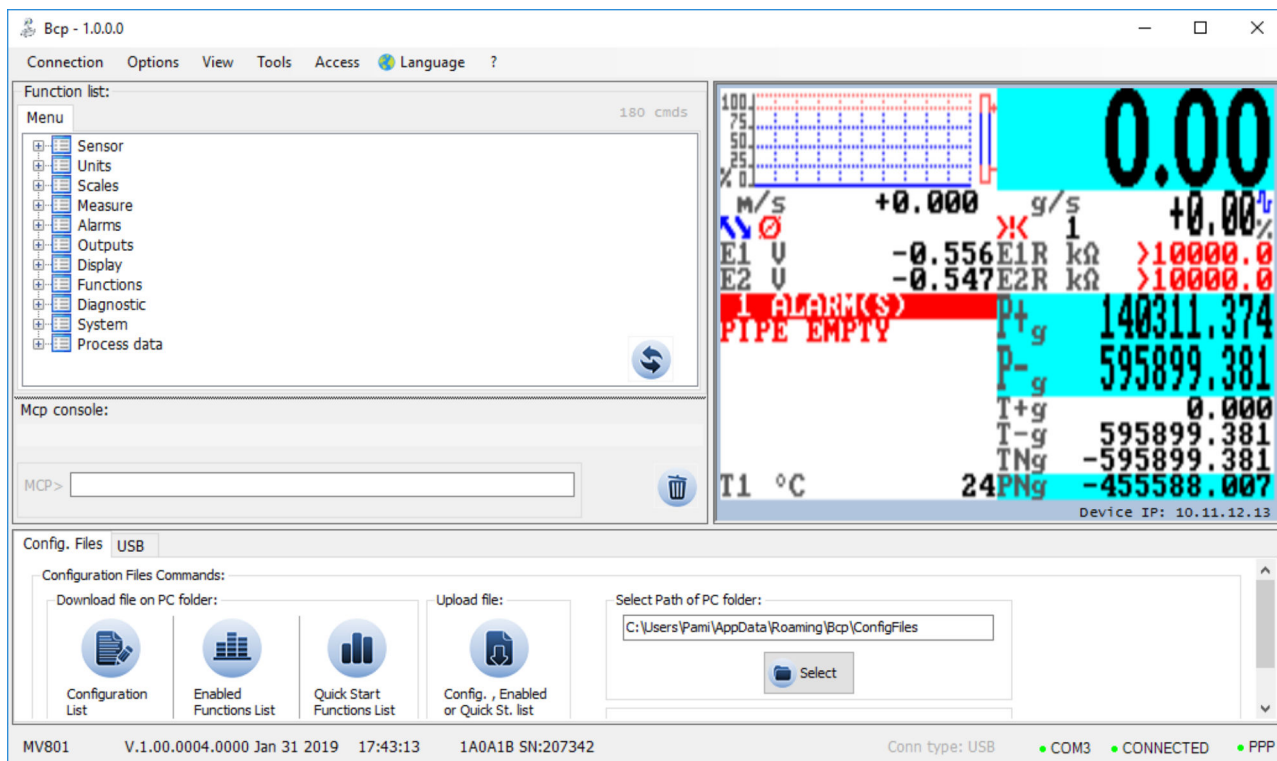

The BCP control software is used to configure and operate the flow sensor.

### 7.1 BCP Software

Before configuring the flow sensor via the BCP software, ensure that:

- The flow sensor is connected to a PC via the USB port.
  - ↳ 6.1 "Create USB interface" on page 41
- The BCP software is installed on the PC with all drivers.
  - ↳ 6.2 "BCP software installation" on page 42





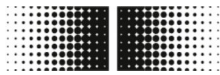

## Configuration files

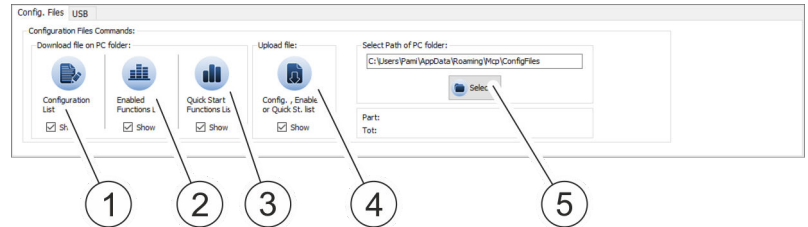

The operating area stores and loads various lists of system settings and parameters.

The lists can be displayed and edited as a TXT file in an editor.

No.	Description	Description
1	List of system configurations	The list contains all the settings and parameters of the flow sensor.
2	List of activated functions	The list contains all activated functions.
3	List of the quick start menu	The list contains all the functions available in the quick start menu.
4	Menu for uploading the list	In the menu, saved or edited lists can be uploaded and read in.
5	Folder path to save the lists	The folder path for saving and loading lists is selected in this input field.

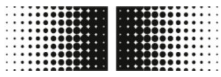

## BCP command input

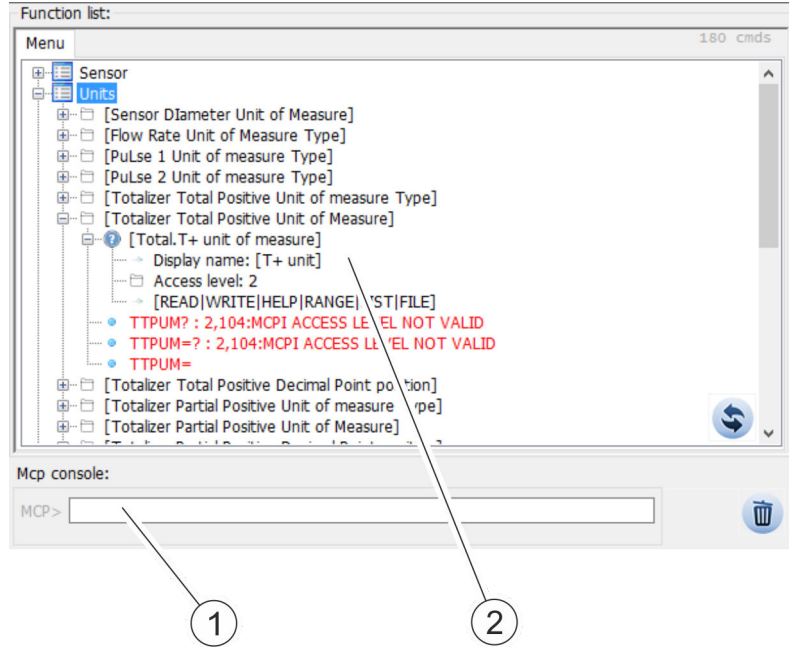

- 1 Menu for BCP functions
- 2 Console for BCP commands

The entire menu structure for BCP commands is displayed in a grouped and collapsible list of all functions.

BCP commands are entered with the appropriate values in the command output console.

The entire list of all BCP commands is provided in the description of menus and functions:

🔗 7.6 “Menu navigation” on page 58

## 7.2 Visualization view



*The functionality and available capabilities of the flow sensor vary depending on the order configuration and type code.*

*Depending on the configuration of the flow sensor or activated functions, individual menus and selection functions may differ from the representations or be hidden.*

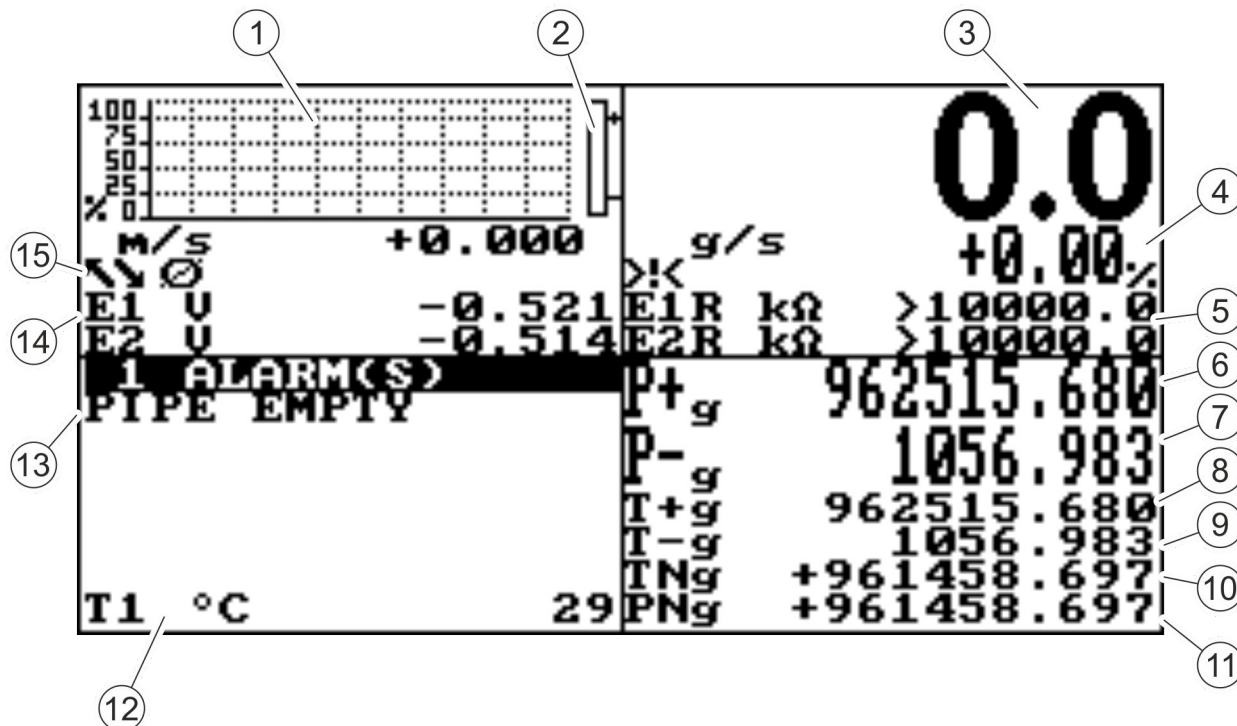

Fig. 5: Visualization view (sample illustration)

No.	Description
1	<b>Graphical representation of the flow rate</b>
2	<b>Graphical representation of the flow rate trend</b>
3	<b>Current flow rate</b> A 5-digit value is displayed regardless of the position of the decimal point. <ul style="list-style-type: none"> <li>■ Maximum representable value: 99999</li> <li>■ Minimum representable value: 0.0025</li> </ul> The current value of the flow rate is displayed in the unit set in the menu. ↪ 7.6.2 "Units menu" on page 62
4	<b>Current scale end value</b> ↪ 7.6.3 "Scales menu" on page 66
5	<b>Resistance value of the sensor electrodes</b>
6	<b>Positive part counter</b>
7	<b>Negative part counter</b>
8	<b>Positive total counter</b>
9	<b>Negative total counter</b>
10	<b>Net total counter</b>



No.	Description
11	Net part counter
12	Liquid temperature
13	Alarms ↳ 9.1 "Alarms" on page 93
14	Voltage value of the sensor electrodes
15	Pictograms ↳ "Pictograms" on page 52

## Pictograms

The following pictograms are displayed in the BCP software visualization view:

Pictogram	Description	Pictogram	Description
	Empty measuring tube		Alarm minimum flow
	Upload of files		Alarm maximum flow
	Download of files		Video connection connected
	Flow simulation (Pictogram flashes)		Overflow flow rate
	Calibration (Pictogram flashes)		Overflow Impulse 1
	Alarm (Pictogram flashes)		Overflow Impulse 2
	Signal error		Excitation error

The complete list of all error messages and alarms can be found in the section *Faults*:

↳ 9 "Fault elimination" on page 93

## 7.3 Quick start menu



The quick start menu provides quick access to some of the most commonly used functions.

Pressing the Enter button opens the quick start menu.



*The quick start menu can be activated in the Display menu.*

↳ 7.6.9 “Display menu” on page 80

*Using the BCP software, the quick start menu can be adapted to the respective application.*

↳ 7.6.12.1 “System menu - additional BCP commands” on page 88

The main menu is also available with all functions:

↳ “Main menu” on page 58

## 7.4 Access codes

Access to the menus and functions of the flow sensor is provided by 6 grouped password levels. Each password level is protected by a different code.

The access code must be entered when opening the quick start menu or the main menu.

The following access codes are set at the factory:

L1	10000000	L4	40000000
L2	20000000	L5	57291624
L3	30000000	L6	65940123



The access codes can be changed in the System menu.

↳ 7.6.12 “System menu” on page 87

Different menus or functions are available depending on the access code. Menus and functions for higher password levels are grayed out or are not displayed.

In order to be able to make necessary settings, the access code of the higher password level must be entered beforehand.

If the function `Restr.access` is activated, then only menus and functions can be accessed which correspond exactly to the level of the access code.

If the `Restr.access` function is disabled, then the menus and functions corresponding to the level of the access code and all the lower password levels can be accessed.



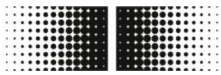

### 7.5 Operation: Example

The menu navigation and selection of functions in the main menu and quick start menu is performed with the following buttons on the keyboard:

- **[Enter]**
  - Open menus
  - Activate editing of values
  - Confirm selection
  - Confirm entries
- **Arrow keys [Up/Down]**
  - Select menus and functions
  - Set values
- **Arrow keys [Left/Right]**
  - Select menus and functions
  - Set values
  - Activate/deactivate functions
- **[ESC]**
  - Cancel entries
  - Close menus
  - Deselect selection

The following examples show how the scale end value is changed.

- Changing the scale end value via the quick start menu:
  - ↳ 7.5.1 “Operation: Example quick start menu” on page 54
- Changing the scale end value via the main menu:
  - ↳ 7.5.2 “Operation: Example main menu” on page 56

#### 7.5.1 Operation: Example quick start menu

The following example shows how the scale end value is changed from 0.4 dm<sup>3</sup>/s to 0.5 dm<sup>3</sup>/s via the quick start menu.

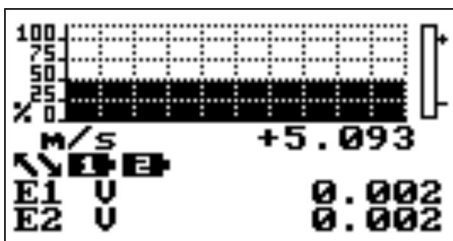

1. ➤ Open the quick start menu by pressing **[Enter]**.
  - ⇒ The menu for inputting the access code will open.

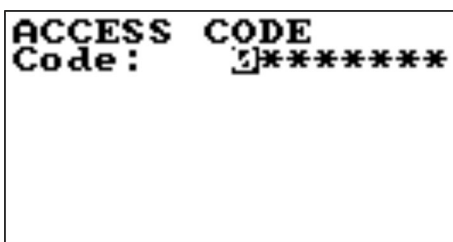

2. ➤ Enter the access code.
  - Use the **[Left/Right]** arrow keys to enter the characters.
  - Use the **[Up/Down]** arrow keys to select the number.

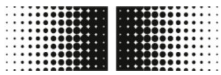

```
ACCESS CODE
Code: 5j*****
```

3. ➤ Confirm the access code entry by pressing *[Enter]*.  
⇒ The quick start menu opens.

```
QUICK START
S.model= 000
FS1=dm³/s 04.000
Main menu
```

4. ➤ Select the scale end value function FS1.  
■ Use the *[Up/Down]* arrow keys to select.  
■ Confirm your selection by pressing *[Enter]*.  
⇒ The scale end value can be changed.

```
QUICK START
S.model= 000
FS1=dm³/s 04.000
Main menu
```

5. ➤ Select the value for the scale end value with the *[Left/Right]* arrow keys.

```
QUICK START
S.model= 000
FS1=dm³/s 031.000
Main menu
```

6. ➤ Set the value for the scale end value with the *[Up/Down]* arrow keys.

```
QUICK START
S.model= 000
FS1=dm³/s 051.000
Main menu
```

7. ➤ Confirm the amended scale end value by pressing *[Enter]*.  
⇒ The scale end value has been changed.

```
QUICK START
S.model= 000
FS1=dm³/s 051.000
Main menu
```

8. ➤ Close the quick start menu by pressing *[ESC]*.  
⇒ The display changes to the Visualization view.

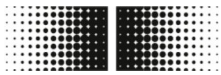

### 7.5.2 Operation: Example main menu

The following example shows how the scale end value is changed from 0.4 dm<sup>3</sup>/s to 0.5 dm<sup>3</sup>/s via the main menu.

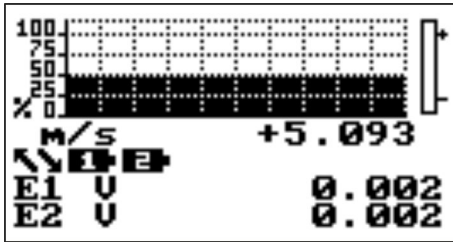

1. ▶ Open the quick start menu by pressing **[Enter]**.  
⇒ The menu for inputting the access code will open.

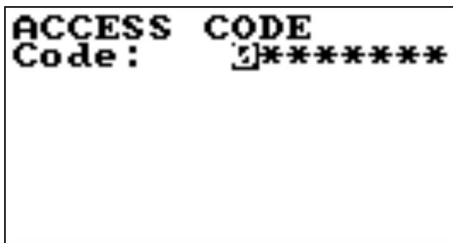

2. ▶ Enter the access code.
  - Use the arrow keys **[Left/Right]** to enter the characters.
  - Use the **[Up/Down]** arrow keys to select the number.

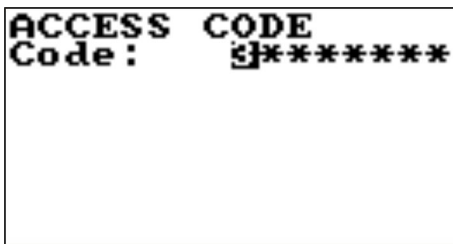

3. ▶ Confirm the access code entry by pressing **[Enter]**.  
⇒ The quick start menu opens.



4. ▶ Select the **Main** menu with the **[Up/Down]** arrow keys.



5. ▶ Open the **Main** menu by pressing **[Enter]**.  
⇒ The **Main** menu opens.



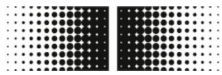

6. ➤ Select the Scales menu with the [Up/Down] arrow keys.

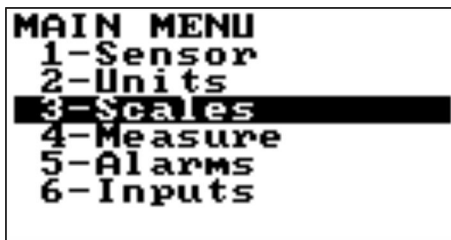

7. ➤ Open the Scales menu by pressing [Enter].  
⇒ The Scales menu opens.

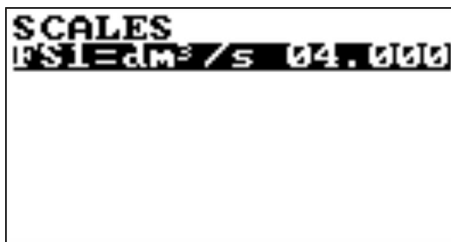

8. ➤ Select the scale end value function FS1.  
■ Use the [Up/Down] arrow keys to select.  
■ Confirm your selection by pressing [Enter].

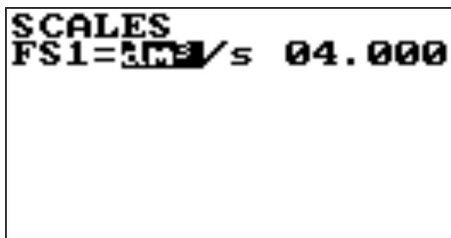

9. ➤ Select the value for the scale end value with the [Left/Right] arrow keys.

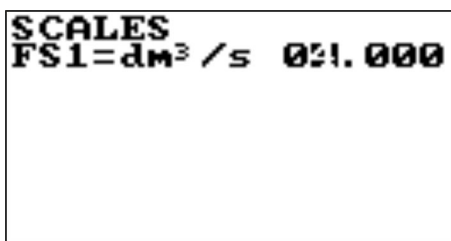

10. ➤ Set the value for the scale end value with the [Up/Down] arrow keys.

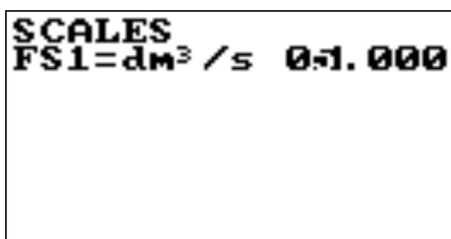

11. ➤ Confirm the amended scale end value by pressing [Enter].  
⇒ The scale end value has been changed.

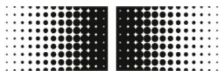

**12.** Close the Scales menu by pressing [ESC].

⇒ The Main menu opens.



**13.** Close the Main menu by pressing [ESC].

⇒ The display changes to the Visualization view.

## 7.6 Menu navigation

### Main menu



The Main menu is located in the lower right corner of the visualization view.



*The functionality and available capabilities of the flow sensor vary depending on the order configuration and type code.*

*Depending on the configuration of the flow sensor or activated functions, individual menus and selection functions may differ from the representations or be hidden.*

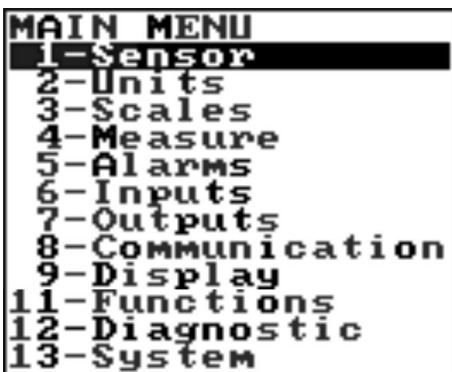

The following menus are available for selection in the Main menu:

Menu	Description
Sensor	↪ 7.6.1 "Sensor menu" on page 60
Units	↪ 7.6.2 "Units menu" on page 62
Scales	↪ 7.6.3 "Scales menu" on page 66
Measure	↪ 7.6.4 "Measure menu" on page 68
Alarms	↪ 7.6.5 "Alarms menu" on page 71
Inputs	↪ 7.6.6 "Inputs menu" on page 73
Outputs	↪ 7.6.7 "Outputs menu" on page 75
Communication	↪ 7.6.8 "Communication menu" on page 79
Display	↪ 7.6.9 "Display menu" on page 80

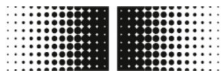

Menu	Description
Functions	↳ 7.6.10 " <i>Functions menu</i> " on page 81
Diagnostic	↳ 7.6.11 " <i>Diagnostic menu</i> " on page 82
System	↳ 7.6.12 " <i>System menu</i> " on page 87

The following menus are also available as an BCP command in the command input of the BCP software:

Menu	Description
Process data	↳ 7.6.13 " <i>Process data menu</i> " on page 90



## 7.6.1 Sensor menu

```

MAIN MENU
1-Sensor
SENSOR
S.model=      000
Lining=      UNSPEC.
U.type=      METRICHE
Diam.=mm     25
KA=          +00.7771
KA-=         01.0000
KZ=          +0000000
KD=          +00000
E.P.Detect=  ON
R.max=kohm   0500
S.err.delay= 010
Sens.verify= OFF
Zero point cal.
  
```



The functionality and available capabilities of the flow sensor vary depending on the order configuration and type code.

Depending on the configuration of the flow sensor or activated functions, individual menus and selection functions may differ from the representations or be hidden.

Menu	Description	Password level / BCP command	
S. model	<b>Sensor model</b> Enter the first characters of the serial number on the type plate of the sensor	L 4	SMODL
Lining	<b>Type of lining material</b> Selection of the type of lining material of the sensor: <ul style="list-style-type: none"> <li>■ PFA</li> <li>■ PU-TDI</li> <li>■ ALON</li> <li>■ PEEK</li> <li>■ HR</li> <li>■ PP</li> <li>■ PA-11</li> <li>■ PTFE-HT</li> <li>■ PTFE</li> </ul>	L 4	LIMAT
U.type	<b>Measurement system</b> Selection of the measurement system: <ul style="list-style-type: none"> <li>■ Metric measurement system</li> <li>■ Anglo-American measurement system</li> </ul>	L 4	SUTYP
Diam.	<b>Sensor diameter</b> Selection of the sensor diameter: <ul style="list-style-type: none"> <li>■ 0 – 2500 (DN see type plate)</li> </ul>	L 4	PDIMV
KA	<b>Calibration coefficient</b>	L 4	CFFKA
KA-	<b>Calibration coefficient for negative flow</b> This function is only displayed if at least one negative calibration coefficient is set.	L 4	CFFKN



Menu	Description	Password level / BCP command	
KZ	<b>Calibration factor (zero point)</b>	L 4	CFFKZ
KD	<b>Dynamic calibration factor</b>	L 4	CFFKD
E.P.detect	<b>Empty pipe detection</b> Activation and deactivation of empty pipe detection	L 4	EPDEN
R max	<b>Empty pipe detection threshold</b> The maximum resistance at the inputs (electrodes) determines the condition of the empty pipes. This selection is present if empty pipe detection is activated. (see E.P.detect)	L 4	EPDTH
S.err.delay	<b>Error signal delay</b> Delay time before an error signal This function is useful for preventing unexpected zero-point locking due to sporadic events (empty pipe, exciter error, signal error).	L 4	SEALT
Sens.verify	<b>Automatic activation of sensor verification</b>	L 3	ASVFE
Zero point cal.	<b>Zero point calibration</b> This function is only displayed if the following process conditions are fulfilled: <ul style="list-style-type: none"> <li>■ The recommended Damping is set to SMART.</li> <li>■ A stable flow rate and less than 0.1% of the absolute threshold (10 m / s) is present.</li> <li>■ At least 10 minutes have elapsed since the last significant change in flow rate.</li> </ul> For zero calibration, make sure that the measuring pipe is completely filled with liquid and the liquid is completely still. Even the smallest movements of liquid can cause considerable measuring errors.	—	—



## 7.6.2 Units menu

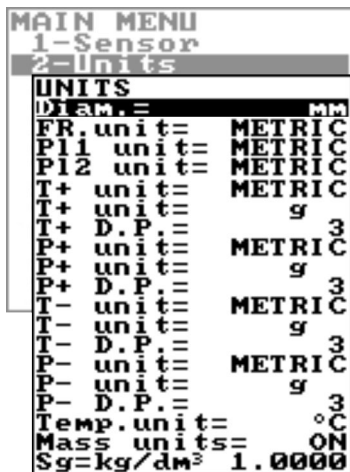

The functionality and available capabilities of the flow sensor vary depending on the order configuration and type code.

Depending on the configuration of the flow sensor or activated functions, individual menus and selection functions may differ from the representations or be hidden.



### NOTICE!

#### Accuracy losses when changing the units of measurement

The total counters and part counters are updated depending on the setting of the units.

The rounding caused by this can lead to loss of accuracy.

Example:

- Total counter T + = 0.234 l (unit with 3 decimal places)
- Change to unit m<sup>3</sup>
- Total counter T + = 0.001 m<sup>3</sup> (0.234 liters have been lost due to rounding)

Menu	Description	Password level / BCP command	
Sens.diameter unit of measure	<b>Nominal diameter unit</b> <ul style="list-style-type: none"> <li>■ mm</li> <li>■ inches</li> </ul>	L 2	SDIUM
FR.unit	<b>Flow rate measuring system</b> <ul style="list-style-type: none"> <li>■ Metric measurement system</li> <li>■ Anglo-American measurement system</li> </ul>	L 2	FRMUT
P11 unit	<b>Measurement system for Impulse 1</b> <ul style="list-style-type: none"> <li>■ Metric measurement system</li> <li>■ Anglo-American measurement system</li> </ul>	L 2	PL1UT
P12 unit	<b>Measurement system for Impulse 2</b> <ul style="list-style-type: none"> <li>■ Metric measurement system</li> <li>■ Anglo-American measurement system</li> </ul>	L 2	PL2UT

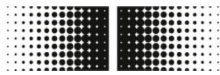

Menu	Description	Password level / BCP command	
T+ unit	<b>Measuring system for positive total counter</b> <ul style="list-style-type: none"> <li>■ Metric measurement system</li> <li>■ Anglo-American measurement system</li> </ul>	L 2	TTPUT
T+ unit	<b>Unit for positive total counter</b> ↪ "Units" on page 64	L 2	TTPUM
T+ D.P.	<b>Decimal places for positive total counter</b> <ul style="list-style-type: none"> <li>■ Value 0 generates 0 in the display</li> <li>■ Value 1 generates 0.0 in the display</li> <li>■ Value 2 generates 0.00 in the display</li> <li>■ Value 3 generates 0,000 in the display</li> </ul>	L 2	TTPDP
P+ unit	<b>Measurement system for positive part counter</b> <ul style="list-style-type: none"> <li>■ Metric measurement system</li> <li>■ Anglo-American measurement system</li> </ul>	L 2	TPPUT
P+ unit	<b>Unit for positive part counter</b> ↪ "Units" on page 64	L 2	TPPUM
P+ D.P.	<b>Decimal places for positive part counter</b> <ul style="list-style-type: none"> <li>■ Value 0 generates 0 in the display</li> <li>■ Value 1 generates 0.0 in the display</li> <li>■ Value 2 generates 0.00 in the display</li> <li>■ Value 3 generates 0,000 in the display</li> </ul>	L 2	TPPDP
T- unit	<b>Measurement system for total negative counter</b> <ul style="list-style-type: none"> <li>■ Metric measurement system</li> <li>■ Anglo-American measurement system</li> </ul>	L 2	TTNUT
T- unit	<b>Unit for total negative counter</b> ↪ "Units" on page 64	L 2	TTNUM
T- D.P.	<b>Decimal places for negative total counter</b> <ul style="list-style-type: none"> <li>■ Value 0 generates 0 in the display</li> <li>■ Value 1 generates 0.0 in the display</li> <li>■ Value 2 generates 0.00 in the display</li> <li>■ Value 3 generates 0,000 in the display</li> </ul>	L 2	TTNDP
P- unit	<b>Measurement system for negative part counter</b> <ul style="list-style-type: none"> <li>■ Metric measurement system</li> <li>■ Anglo-American measurement system</li> </ul>	L 2	TPNUT



Menu	Description	Password level / BCP command	
P- unit	<b>Unit for negative part counter</b> 🔗 <i>"Units" on page 64</i>	L 2	TPNUM
P- D.P.	<b>Decimal places for negative part counter</b> <ul style="list-style-type: none"> <li>■ Value 0 generates 0 in the display</li> <li>■ Value 1 generates 0.0 in the display</li> <li>■ Value 2 generates 0.00 in the display</li> <li>■ Value 3 generates 0,000 in the display</li> </ul>	L 2	TPNDP
Temp.unit	<b>Unit for temperature measurement</b>	L 2	TMPUT
Mass units	<b>Weight unit in the end area</b> Activation and deactivation of weight unit selection in the end area.	L 2	MSSUE
Sg=kg/dm <sup>3</sup>	<b>Specific weight coefficient</b> Setting of specific weight coefficient Needed to convert the measured volume into weight units.	L 2	VMSGC

## Units

Volume units:		
cm <sup>3</sup>	Cubic centimeters	metric
ml	Milliliters	metric
l	Liters	metric
dm <sup>3</sup>	Cubic decimeters	metric
dal	Decaliters	metric
hl	Hectoliters	metric
m <sup>3</sup>	Cubic meters	metric
ML	Megaliters	metric
in <sup>3</sup>	Inch	not metric
Gal	American gallon	not metric
ft <sup>3</sup>	Cubic feet	not metric
bbl	Standard barrel	not metric
BBL	Oil barrel	not metric
I GL	British gallon	not metric



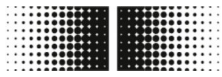

Weight units:		
g	Gram	metric
kg	Kilograms	metric
t	Ton	metric
OZ	Ounce	not metric
Lb	American pound	not metric
Ton	American ton	not metric



## 7.6.3 Scales menu



The functionality and available capabilities of the flow sensor vary depending on the order configuration and type code.

Depending on the configuration of the flow sensor or activated functions, individual menus and selection functions may differ from the representations or be hidden.

Menu	Description	Password level / BCP command	
FS1	<p><b>Flow - scale end value 1</b></p> <p>With scale end value 1, the maximum flow rate is set in volume per time.</p> <p>The scale end value must be between 4 and 100% of the maximum possible flow rate.</p> <p>For the automatic change of the measuring range <i>Autorange</i> it must be ensured that Scale end value 2 FS2 is larger than the Scale end value 1 FS1.</p>	L 2	FRFS1
FS2	<p><b>Flow - scale end value 2</b></p> <p>With scale end value 2, the maximum flow rate is set in volume per time.</p> <p>The scale end value must be between 4 and 100% of the maximum possible flow rate.</p> <p>For the automatic change of the measuring range <i>Autorange</i> it must be ensured that Scale end value 2 FS2 is larger than the Scale end value 1 FS1.</p>	L 2	FRFS2
Pls1	<p><b>Pulse Channel 1</b></p> <p>The value defines the measured flow rate for which a pulse is generated at Channel 1.</p>	L 2	OP1PV
Tpls1	<p><b>Duration of the pulse generated at Channel 1</b></p> <p>The value sets the duration of the pulse generated at Channel 1.</p> <p>It can be anywhere between 0.4 and 9999.99.</p>	L 2	OP1PT

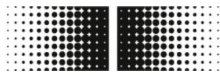

Menu	Description	Password level / BCP command	
Pls2	<b>Pulse Channel 2</b> The value defines the measured flow rate for which a pulse is generated at Channel 2.	L 2	OP2PV
Tpls2	<b>Duration of the pulse generated at Channel 2</b> The value sets the duration of the pulse generated at Channel 2. The value can be between 0.4 and 9999.99 milliseconds.	L 2	OP2PT

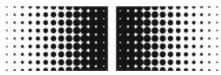

## 7.6.4 Measure menu



The functionality and available capabilities of the flow sensor vary depending on the order configuration and type code.

Depending on the configuration of the flow sensor or activated functions, individual menus and selection functions may differ from the representations or be hidden.

Menu	Description	Password level / BCP command	
Damping	<p><b>Damping filters</b></p> <p>The choice of damping filter, depending on the system requirements, is crucial for the accurate measurement of flow rate.</p> <p>☞ "Damping filters" on page 69</p>	L 3	MFDMP
Cut-off	<p><b>Threshold for low flow</b></p> <p>This function prevents a near-zero flow rate due to electrical noise or minute flow (such as tube vibration) from increasing the total meter.</p> <p>The threshold can be 0 - 25% of the set scale end value.</p> <p>A value between 0.5 and 1 % is recommended for most applications.</p>	L 3	MFCUT



Menu	Description	Password level / BCP command	
Cal.verify	<p><b>Automatic calibration function</b></p> <p>This feature should only be used for large temperature ranges.</p>	L 3	ACAVE
Autorange	<p><b>Automatic change of the measuring range</b></p> <p>Two different working ranges allow variable adaptation to different process conditions.</p> <p>It must be ensured that Scale end value 2 FS2 is greater than Scale end value 1 FS1.</p> <p>When the flow rate increases and reaches 100% of Scale end value 1 FS1, the system automatically switches to Scale end value 2 FS2.</p> <p>When the flow rate decreases and the Scale end value 2 FS2 reaches a value equivalent to 90 % of Scale end value 1 FS1, the system automatically switches to Scale end value 1 FS1.</p> <p>This feature does not increase the accuracy of the measurement.</p> <p>The goal is to increase the 4/20 mA resolution when the sensor measures at very low flow rates.</p>	L 3	ARNGE

## Damping filters

The choice of damping filter, depending on the system requirements, is crucial for the accurate measurement of flow rate.

### Smart

The selection `SMART` is the recommended setting for the damping of the measured values.

With this adaptive damping filter, the sensor can respond very quickly to changes in flow, while being precise and stable with slow fluctuations in flow.

### Damping filter deactivated

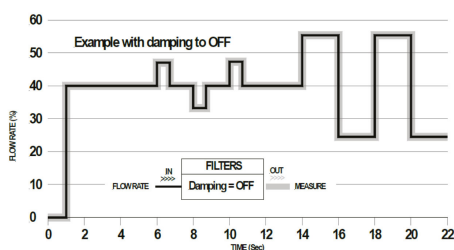

With inactive damping `OFF`, successive values cause an increasing damping of the measured values.

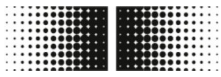

## Damping filter time-dependent

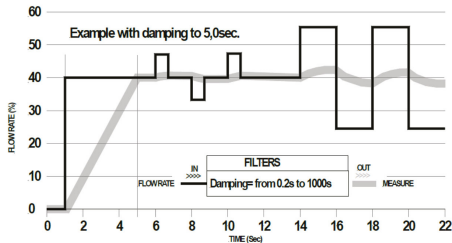

It may be appropriate to use a constant time for the damping filter, for example for a pulsating flow.

The flow is averaged over a number of readings. The damping filter dampens the measurement noise and the sudden change in the flow rate. Increasing the damping parameter increases the stability of the measurement.

Longer times produce a stable average. For short times, the measurement follows the measured values closely and is therefore more unstable.

### 7.6.4.1 Measure menu - additional BCP commands

The following menus are also available as an BCP command in the command input of the BCP software:

Menu	Description	Password level / BCP command	
Measure cut-off threshold 2	<b>Threshold for low flow 2</b> The low flow shutdown threshold setting is the same as Cut-off.	L 3	MFCT2
High immunity input noise filter	<b>Input noise filter with high immunity to interference</b> When this feature is enabled, an immunity to measurement is activated that is approximately 1%.	L 4	HIINP
Dynamic sample analysis	<b>Dynamic analysis</b>	L 4	DINSA
Dynamic sample time	<b>Dynamic analysis time</b>	L 4	DYNST

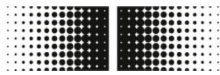

## 7.6.5 Alarms menu



The functionality and available capabilities of the flow sensor vary depending on the order configuration and type code.

Depending on the configuration of the flow sensor or activated functions, individual menus and selection functions may differ from the representations or be hidden.

Menu	Description	Password level / BCP command	
Max.thr+	<p><b>Maximum value for positive flow</b></p> <p>If the maximum value for the positive flow exceeds the set value, an alarm message is generated.</p> <p>The value of this parameter is set as a percentage (0 - 125%) of the scale end value.</p> <p>If the parameter is 0, the alarm generation is deactivated.</p>	L 3	FRAXP
Max.thr-	<p><b>Maximum value for negative flow</b></p> <p>If the maximum value for the negative flow exceeds the set value, an alarm message is generated.</p> <p>The value of this parameter is set as a percentage (0 - 125%) of the scale end value.</p> <p>If the parameter is 0, the alarm generation is deactivated.</p>	L 3	FRAXN
Min.thr+	<p><b>Minimum value for positive flow</b></p> <p>If the minimum value for the positive flow falls below the set value, an alarm message is generated.</p> <p>The value of this parameter is set as a percentage (0 - 125%) of the scale end value.</p> <p>If the parameter is 0, the alarm generation is deactivated.</p>	L 3	FRANP



Menu	Description	Password level / BCP command	
Min.thr-	<p><b>Minimum value for negative flow</b></p> <p>If the minimum value for the negative flow falls below the set value, an alarm message is generated.</p> <p>The value of this parameter is set as a percentage (0 - 125%) of the scale end value.</p> <p>If the parameter is 0, the alarm generation is deactivated.</p>	L 3	FRANN
T1 max	<p><b>Maximum value for temperature T1</b></p> <p>If the maximum value for the temperature is exceeded, an alarm message is generated.</p> <p>If the parameter is 0, the alarm generation is deactivated.</p>	L 3	TMP1X
T1 min	<p><b>Minimum value for temperature T1</b></p> <p>If the minimum value for the temperature is exceeded, an alarm message is generated.</p> <p>If the parameter is 0, the alarm generation is deactivated.</p>	L 3	TMP1N
Hysteresis	<p><b>Hysteresis threshold for minimum and maximum flow</b></p> <p>The value of this parameter is expressed as a percentage of the scale end value and can be set from 0 - 25%.</p>	L 3	ATHYS
mA v.alarm	<p><b>Alarm value for output current</b></p> <p>The alarm value for the output current can be triggered when an empty line, a broken coil or an ADC error occurs.</p> <p>The value is set as a percentage (0 - 125%) of the 0 - 20 mA current.</p> <p>It is recommended to set the value of this function to 10% so that the maximum deviation is a maximum of 2 mA in all cases.</p>	L 3	OCACV
Hz v.alarm	<p><b>Alarm value for frequency value</b></p> <p>The value is set as a percentage (0 - 125%) of the frequency.</p>	L 3	OFACV





## 7.6.6 Inputs menu

```

MAIN MENU
1-Sensor
2-Units
3-Scales
4-Measure
5-Alarms
6-Inputs

```

```

INPUTS
T+ reset= OFF
P+ reset= OFF
T- reset= OFF
P- reset= OFF
Count lock= OFF
Meas.lock= OFF
Calibration= OFF
Range change=OFF

```

**i** *The functionality and available capabilities of the flow sensor vary depending on the order configuration and type code.*

*Depending on the configuration of the flow sensor or activated functions, individual menus and selection functions may differ from the representations or be hidden.*

Menu	Description	Password level / BCP command	
T+ reset	<b>Release for resetting positive total counter</b> If the function is activated, an external signal can be used to reset the positive total counter.	L 3	VTTPE
P+ reset	<b>Release for resetting positive part counter</b> If the function is activated, an external signal can be used to reset the positive part counter.	L 3	VTPPE
T- reset	<b>Release for resetting negative total counter</b> If the function is activated, an external signal can be used to reset the negative total counter.	L 3	VTTNE
P- reset	<b>Release for resetting negative part counter</b> If the function is activated, an external signal can be used to reset the negative part counter.	L 3	VTPNE
Count lock	<b>Stop total counter</b> If the function is activated, an external signal can be used to stop the total counter regardless of the actual flow rate.	L 3	TCLIE
Meas.lock	<b>Stop measurement</b> If the function is activated, the measurement can be stopped by an external signal. The meter indicates zero flow.	L 3	MSLIE



Menu	Description	Password level / BCP command	
Calibration	<p><b>External calibration command</b></p> <p>If the function is activated, zero calibration can be performed by an external signal.</p> <ul style="list-style-type: none"><li>■ If the voltage pulse of the external signal is shorter than 1 s, the instrument performs a calibration cycle to compensate for any potential thermal variations.</li><li>■ If the voltage pulse of the external signal is longer than 1 s, the meter performs a zero calibration measurement.</li></ul> <p>For zero calibration, make sure that the measuring pipe is completely filled with liquid and the liquid is completely still. Even the smallest movements of liquid can cause considerable measuring errors.</p>	L 3	CALIE
Range change	<p><b>Change of the measuring range</b></p> <p>If the function is activated, the measuring range can be changed by an external signal.</p> <p>This function cannot be activated if the <i>Autorange</i> function is activated.</p>	L 3	SRCIE



## 7.6.7 Outputs menu

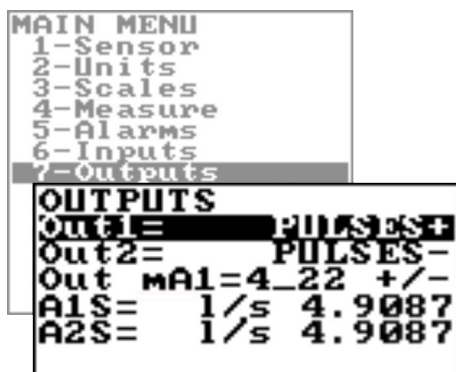

The functionality and available capabilities of the flow sensor vary depending on the order configuration and type code.

Depending on the configuration of the flow sensor or activated functions, individual menus and selection functions may differ from the representations or be hidden.

Menu	Description	Password level / BCP command	
Out1	<b>Function selection Output 1</b> Function selection for Digital Output 1. ☞ "Functions for outputs" on page 75	L 3	OUT1F
Out2	<b>Function selection Output 2</b> Function selection for Digital Output 2. ☞ "Functions for outputs" on page 75	L 3	OUT2F
Out mA1	<b>Analog output current range</b> This function sets the Analog output. ☞ "Analog output current range" on page 76	L 3	AO1CF
A1S	<b>Scale end value for Analog output 1</b> The scale end value for Analog output 1 can be set independently of the end value of the sensor.	L 3	AO1FS
A2S	<b>Scale end value for Analog output 2</b> The scale end value for Analog output 2 can be set independently of the scale end value of the sensor.	L 3	AO2FS

### Functions for outputs

The following functions can be set via the menu `Out1` for digital output 1 and via the menu `Out2` for digital output 2:

OFF	DISABLE
MAX AL. +	MAX DIRECT FLOW RATE OUTPUT (ENERGIZED = AL. OFF)
MIN AL. +	MIN DIRECT FLOW RATE OUTPUT (ENERGIZED = AL. OFF)
MAX AL.-	MAX INVERSE FLOW RATE OUTPUT (ENERGIZED = AL. OFF)

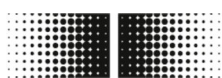

MIN AL.-	MIN INVERSE FLOW RATE OUTPUT (ENERGIZED = AL. OFF)
MAX/MIN-	MAX/MIN INVERSE FLOW RATE OUTPUT (ENERGIZED = AL. OFF)
MAX/MIN+/-	MAX/MIN DIRECT FLOW RATE OUTPUT (ENERGIZED = AL. OFF)
P.EMPTY	EMPTY PIPE ALARM OUTPUT (ENERGIZED = AL. OFF)
AL.SYSTEM	SUM OF ALL ALARMS "energized interrupted" AND "error input signal"
OVERFLOW	OUT OF RANGE ALARM OUTPUT (ENERGIZED = FLOWRATE OK)
ALL ALARMS	SUM OF ALL ALARMS POSSIBLE
MANUAL	OUTPUT MAY TAKE A STATE EMPLOYEE FROM AN EXTERNAL CONTROL (BCP,MODBUS, ecc)
FLOW RATE SIGN.	FLOW DIRECTION (ENERGIZED WHEN FLOW IS NEGATIVE)
SCALE	INDICATION SCALE
FREQ.+	FREQUENCY POSITIVE FLOWRATE
FREQ.-	FREQUENCY NEGATIVE FLOWRATE
FREQ.+/-	FREQUENCY POSITIVE/NEGATIVE FLOWRATE
PULSES.+	PULSE POSITIVE FLOW RATE
PULSES.-	PULSE NEGATIVE FLOW RATE
PULSES+/-	PULSE NEGATIVE/POSITIVE FLOW RATE

## Analog output current range

For the analog outputs current range, the following three values must be set:

- Zero flow:
  - 4 mA
  - 0 mA
- Scale end value:
  - 20 mA
  - 22 mA
- Field (dependencies see table):
  - + = positive flow direction
  - - = negative flow direction
  - blank = both flow directions
  - 0 = zero flow

The values that correspond to the update points are shown in the following table:

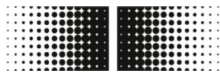

Current range	negative flow direction		Zero flow	positive flow direction	
	≤ - 110 %	- 100 %	0 %	+ 100 %	≥ + 110 %
Out.mA = 0 – 20 (+)	0	0	0	20	20
Out.mA = 0 – 22 (+)	0	0	0	20	22
Out.mA = 4 – 20 + 4	4	4	4	20	20
Out.mA = 4 – 22 (+) (Example 1)	4	4	4	20	21.6
Out.mA = 0 – 20 (-)	20	20	0	0	0
Out.mA = 0 – 22 (-)	22	20	0	0	0
Out.mA = 4 – 20 (-)	20	20	4	4	4
Out.mA = 4 – 22 (-)	21.6	20	4	4	4
Out.mA = 0 – 20	20	20	0	20	20
Out.mA = 0 – 22	22	20	0	20	22
Out.mA = 4 – 20	20	20	4	20	20
Out.mA = 4 – 22	21.6	20	4	20	21.6
Out.mA = 0 – 20 – 0 (+)	0	0	10	20	20
Out.mA = 0 – 22 – 0 (+)	0	1	11	21	22

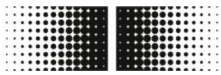

Current range	negative flow direction		Zero flow	positive flow direction	
	$\leq -110\%$	$-100\%$	$0\%$	$+100\%$	$\geq +110\%$
Out.mA = 4 – 20 – 0 (+) (Example 2)	4	4	12	20	20
Out.mA = 4 – 22 – 0 (+)	2	4	12	20	22

### Example 1

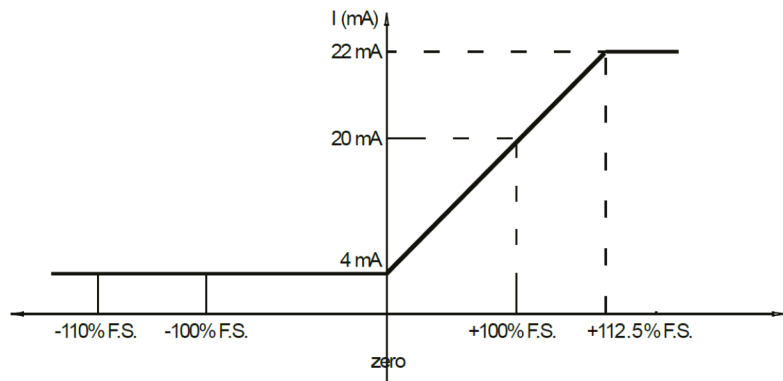

Fig. 6: Out.mA = 4 – 22 +

### Example 2

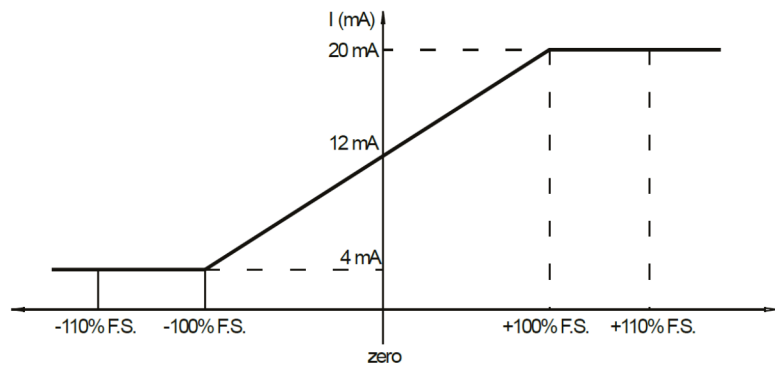
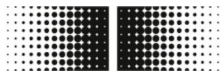

Fig. 7: Out.mA = 4 – 20 – 0+



### 7.6.8 Communication menu



*The functionality and available capabilities of the flow sensor vary depending on the order configuration and type code.*

*Depending on the configuration of the flow sensor or activated functions, individual menus and selection functions may differ from the representations or be hidden.*

Menu	Description	Password level / BCP command	
		Level	Command
HART pr.	HART data packet preamble	L 3	HARTP
Dev. Addr	Device communication address	L 3	DVADD



## 7.6.9 Display menu



The functionality and available capabilities of the flow sensor vary depending on the order configuration and type code.

Depending on the configuration of the flow sensor or activated functions, individual menus and selection functions may differ from the representations or be hidden.

Menu	Description	Password level / BCP command	
Language	<b>Language selection</b> <ul style="list-style-type: none"> <li>■ EN: English</li> <li>■ DE: German</li> <li>■ IT: Italian</li> <li>■ ES: Spanish</li> <li>■ FR: French</li> <li>■ PT: Portuguese</li> </ul>	L 1	LLANG
D. rate	<b>Display frequency</b> Setting of the frequency of updating the display data. The value affects only the display and not the reaction time of the meter.	L 1	DISRF
Part.tot.	<b>Part counter display</b> If this function is active, the part counter is displayed in the visualization view.	L 2	PTOTE
Neg.tot.	<b>Negative total counter display</b> If this function is active, the negative total counter is displayed in the visualization view.	L 2	NEGTE
Net tot.	<b>Function net counter</b> If this function is active, the net counter is displayed in the visualization view.	L 2	NVTTE
Quick start	<b>Quick start menu</b> This function is used to enable or disable quick start.	L 2	QSTME



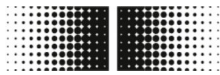

## 7.6.10 Functions menu

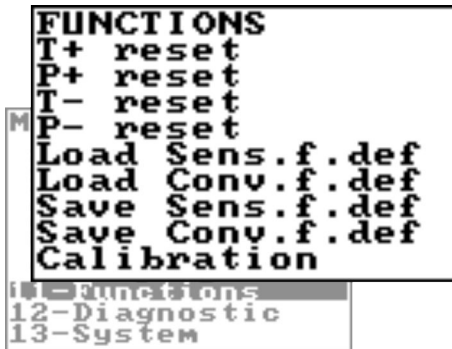

The functionality and available capabilities of the flow sensor vary depending on the order configuration and type code.

Depending on the configuration of the flow sensor or activated functions, individual menus and selection functions may differ from the representations or be hidden.

Menu	Description	Password level / BCP command	
T+ reset	<b>Resetting the positive total counter</b>	L 3	VTTPR
P+ reset	<b>Resetting the positive part counter</b>	L 3	VTPPR
T- reset	<b>Resetting the negative total counter</b>	L 3	VTTNR
P- reset	<b>Resetting the negative part counter</b>	L 3	VTPNR
Load Sens.f.def.	<b>Loading the factory setting of the sensor</b>	L 3	LFSDS
Load Conv.f.def.	<b>Loading the factory setting of the transmitter</b>	L 3	LFDCD
Save Sens.f.def.	<b>Saving the factory setting of the sensor</b>	L 6	SFSDS
Save Conv.f.def.	<b>Saving the factory setting of the transmitter</b>	L 6	SFDCD
Calibration	<b>Performing a circuit calibration</b>  When the function is activated, the message EXECUTE is displayed.  Pressing and holding the Enter key completes the calibration.	L 5	CALIC

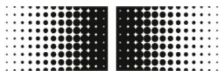

### 7.6.11 Diagnostic menu



The functionality and available capabilities of the flow sensor vary depending on the order configuration and type code.

Depending on the configuration of the flow sensor or activated functions, individual menus and selection functions may differ from the representations or be hidden.

Menu	Description	Password level / BCP command	
Self test	<p><b>Self test</b></p> <p>When the function is activated, the message EXECUTE is displayed.</p> <p>Pressing and holding the Enter key completes the self test.</p> <p>This function is performed automatically each time the sensor is turned on.</p>	L 3	ATSIC
Sens.verify	<p><b>Diagnostic function of the sensor</b></p> <p>With this function, the sensor can be checked manually.</p>	L 3	SVERC
Flow.sim.	<p><b>Flow simulation</b></p> <p>With this function, it is possible to generate an internal signal that simulates the flow rate. The outputs and all connected instruments can be tested this way.</p>	L 3	MSIEN
Display measures	<p><b>Diagnostic values</b></p> <p>Enabling this feature displays a list of internal parameters.</p> <pre> UCPU:U          5.01  LFN_COM:U      0.000 UFS:U           4.41  LFN_DIP:U      0.000 UUSB:U          4.53  LFN_ADC:U      0.000 +AUCC:U         +10.1 LFN_ADC:U      0.001 -AUCC:U          -9.9  MEAS_NB:U      0.000 UBATT:U         0.000  CAL_I:U        16.500 IBATT:A         0.000  CAL_U:U        320.778 VIN1:U         -0.071  CAL_G:U        32.16222 VIN2:U         -0.065  CAL_O:MA      -0.05555 VIN_C:U         -0.068  CAL_C:MA      -0.05555 VIN_D:U         -0.006  CAL_R0:U      1.00000 C_C:MA         25.000  CAL_R1:U      1.00000 C_U:U           5.50  CAL_R2:U      1.00000 C_UPK:U         5.50  CAL_R3:U      1.00000 C_R:Ω          201.9  SYS_F:MHz     50.0512 C_PWR:W         0.126  CRR_F:U       0.00000 C_T:°C          -.-  PROC1:U       46.4 C_RT:ms         0.00  PROC2:U       7.3 C_LK:MA         0.000  PROC3:U       3.8 C_ST:U          1     PROC4:U       29.8 S_UER,RSLT:    0000  PROC5:U       12.6 E1R:kΩ         0.0   CPU_T:°C      +33.12 E2R:kΩ         0.0 </pre>	L 5	DMVLS

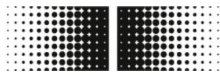

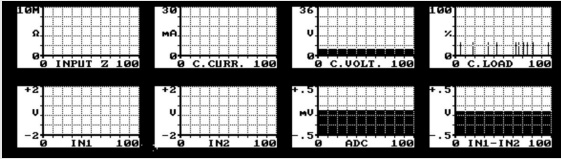
Menu	Description	Password level / BCP command	
Disp.comm.vars.	<b>Diagnostic values communication</b> Enabling this feature displays a list of device communication parameters. <pre> RxCNT:      1477149 E_IP_HDR5:      3 TxCNT:      6515456 E_IP_HDR6:      0 E_SR_LINK:  0 E_IP_HDR7:      0 E_PAKTLEN:  0 E_IP_HDR8:      0 E_NETLAYR:  0 E_IP_HDR9:      0 E_TSPLYR:   0 E_TCPHDR1:     0 E_ARPHDR1:  0 E_TCPHDR2:     0 E_ARPHDR2:  0 E_UDPHDR1:     0 E_IP_HDR1:  0 E_UDPHDR2:     0 E_IP_HDR2:  0 E_UDPHDR3:     92 E_IP_HDR3:  0 E_ICMPHDR:     0 E_IP_HDR4:  0           </pre>	L 5	DCVLS
Display graphs	<b>Graphical displays</b> The function displays graphics for the following values on the X axis: 	L 5	—
Firmware info	<b>Firmware version</b> Display of the firmware version	L 0	MODSV
S/N	<b>Serial number</b> Display of the serial number	L 0	SRNUM
WT	<b>Operating time</b> Display of the total working time	L 0	TWKTM

### 7.6.11.1 Diagnostic menu - additional BCP commands

The following menus are also available as an BCP command in the command input of the BCP software:

Menu	Description	Password level / BCP command	
Real mean value of coils current	<b>Real mean value of coils current</b>	L 6	CCMRV
Diagnostic function	<b>Logging of all event information</b> With this function different functions and properties can be tested with the help of a code. Example: DIAGF = 80 -> FORCE OUT 1 TO COPY THE STATE OF THE IN2	L 6	DIAGF



The codes for using the Diagnostic function feature are listed in the following table:

Function	Description	Code (decimal)	Code (hexadecimal)
NORMAL WORKING	NORMAL WORKING MODE	0	0
FORCE PHASE A	FORCE COIL EXCITATION TO PHASE A	1	1
FORCE PHASE B	FORCE COIL EXCITATION TO PHASE B	2	2
FORCE COILS OFF	FORCE COIL EXCITATION TO OFF	3	3
COILS DIAG BITS	DIAGNOSTIC BITS FOR EXCITATION CONTROL	3	3
FORCE OUT1 ON	FORCE OUT 1 TO ON STATE	16	10
FORCE OUT1 OFF	FORCE OUT 1 TO OFF STATE	32	20
FORCE OUT1 FREQ	FORCE OUT 1 TO OUTPUT 1KHZ SIGNAL	48	30
FORCE OUT1 INP1	FORCE OUT 1 TO COPY THE STATE OF THE IN1	64	40
FORCE OUT1 INP2	FORCE OUT 1 TO COPY THE STATE OF THE IN2	80	50
FORCE OUT1 FREQ2	FORCE OUT 1 TO OUTPUT 64 HZ (SUB-CLOCK CHECK)	96	60
OUT1 DIAG BITS	DIAGNOSTIC BITS FOR OUT1 CONTROL	240	00000F0
FORCE OUT2 ON	FORCE OUT 2 TO ON STATE	256	100
FORCE OUT2 OFF	FORCE OUT 2 TO OFF STATE	512	200
FORCE OUT2 FREQ	FORCE OUT 2 TO OUTPUT 1KHZ SIGNAL	768	300
FORCE OUT2 INP1	FORCE OUT 2 TO COPY THE STATE OF THE IN1	1024	400
FORCE OUT2 INP2	FORCE OUT 2 TO COPY THE STATE OF THE IN2	1280	500
FORCE OUT2 FREQ2	FORCE OUT 2 TO OUTPUT 64 HZ (SUB-CLOCK CHECK)	1536	600
OUT2 DIAG BITS	DIAGNOSTIC BITS FOR OUT2 CONTROL	3840	00000F00
FORCE OUT3 ON	FORCE OUT 3 TO ON STATE	4096	1000
FORCE OUT3 OFF	FORCE OUT 3 TO OFF STATE	8192	2000

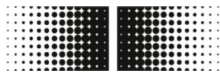

Function	Description	Code (decimal)	Code (hexadecimal)
FORCE OUT3 FREQ	FORCE OUT 3 TO OUTPUT 1KHZ SIGNAL	12288	3000
FORCE OUT3 INP1	FORCE OUT 3 TO COPY THE STATE OF THE IN1	16384	4000
FORCE OUT3 INP2	FORCE OUT 3 TO COPY THE STATE OF THE IN2	20480	5000
FORCE OUT3 FREQ2	FORCE OUT 3 TO OUTPUT 64 HZ (SUB-CLOCK CHECK)	24576	6000
OUT3 DIAG BITS	DIAGNOSTIC BITS FOR OUT3 CONTROL	61440	0000F000
FORCE OUT4 ON	FORCE OUT 4 TO ON STATE	65536	10000
FORCE OUT4 OFF	FORCE OUT 4 TO OFF STATE	131072	20000
FORCE OUT4 FREQ	FORCE OUT 4 TO OUTPUT 1KHZ SIGNAL	196608	30000
FORCE OUT4 INP1	FORCE OUT 4 TO COPY THE STATE OF THE IN1	262144	40000
FORCE OUT4 INP2	FORCE OUT 4 TO COPY THE STATE OF THE IN2	327680	50000
FORCE OUT4 FREQ2	FORCE OUT 4 TO OUTPUT 64 HZ (SUB-CLOCK CHECK)	393216	60000
OUT4 DIAG BITS	DIAGNOSTIC BITS FOR OUT4 CONTROL	983040	000F0000
FORCE AOUT 4MA	FORCE ANALOG OUT TO 4 MA VALUE	1048576	100000
FORCE AOUT 20MA	FORCE ANALOG OUT TO 20 MA VALUE	2097152	200000
FORCE AOUT1 4MA	FORCE ANALOG OUT TO 4 MA VALUE	1048576	100000
FORCE AOUT1 20MA	FORCE ANALOG OUT TO 20 MA VALUE	2097152	200000
FORCE AOUT2 4MA	FORCE ANALOG OUT TO 4 MA VALUE	4194304	300000
FORCE AOUT2 20MA	FORCE ANALOG OUT TO 20 MA VALUE	8388608	400000
AOUT DIAG BITS	DIAGNOSTIC BITS FOR AOUT CONTROL	15728640	00F00000
FORCE SH HOLD	FORCE SAMPLE/HOLD TO HOLD POSITION (SWITCHES OPEN)	16777216	1000000



Function	Description	Code (decimal)	Code (hexadecimal)
FORCE SH SAMPLE	FORCE SAMPLE/HOLD TO SAMPLE POSITION (SWITCHES CLOSE)	33554432	2000000
SH DIAG BITS	DIAGNOSTIC BITS FOR SAMPLE/HOLD CONTROL	50331648	3000000
FORCE INPUTS GND	FORCE MEASURE INPUTS TO GROUND	67108864	4000000
FORCE INPUTS OPEN	FORCE MEASURE INPUTS TO OPEN (DISCONNECTED) STATE	134217728	8000000
INPUTS DIAG BITS	DIAGNOSTIC BITS FOR MEASURE INPUTS CONTROL	201326592	0C000000
FORCE ADC GND	FORCE ADC MEASURE CHANNEL TO GND	268435456	10000000
ADC DIAG BITS	DIAGNOSTIC BITS FOR ADC CONTROL	268435456	10000000
DIAG MODE ACTIVE	DIAGNOSTIC MODE ACTIVE MASK (ANY FUNCTION)	4294967295	FFFFFFF
FORCE AOUT 12MA	FORCE ANALOG OUT TO 12 MA VALUE (GENERIC OUT 1)	3145728	300000
FORCE AOUT1 12MA	FORCE ANALOG OUT TO 12 MA VALUE (OUT 1)	3145728	300000
FORCE AOUT2 12MA	FORCE ANALOG OUT TO 12 MA VALUE (OUT 2)	12582912	00C00000



## 7.6.12 System menu

```

SYSTEM
L1 code=*****
L2 code=*****
L3 code=*****
L4 code=*****
L5 code=*****
L6 code=*****
M Restr.access= ON
  010.011.012.013
  010.011.012.014
  255.255.255.000
KT=      0.96469
KS=      1.00000
KR=      1.00000
DAC1 4mA= 02460
DAC1 20mA= 11050
FW update
13-System
  
```

**i** The functionality and available capabilities of the flow sensor vary depending on the order configuration and type code.

Depending on the configuration of the flow sensor or activated functions, individual menus and selection functions may differ from the representations or be hidden.

Menu	Description	Password level / BCP command	
L1 code	<b>Access Code Level 1</b>	—	L1ACD
L2 code	<b>Access Code Level 2</b>	—	L2ACD
L3 code	<b>Access Code Level 3</b>	—	L3ACD
L4 code	<b>Access Code Level 4</b>	—	L4ACD
L5 code	<b>Access Code Level 5</b>	—	L5ACD
L6 code	<b>Access Code Level 6</b>	—	L6ACD
Restr.access	<b>Access rights limitation</b> If this function is activated, then only menus and functions can be accessed which correspond exactly to the level of the access code.  If this function is deactivated, then the menus and functions corresponding to the level of the access code and all the lower password levels can be accessed.	L 6	RSARE
xxx.xxx.xxx.xxx	<b>IP network address of the device</b>	L 3	DIPAD
xxx.xxx.xxx.xxx	<b>Client IP address</b>	L 3	CIPAD
xxx.xxx.xxx.xxx	<b>Network mask</b>	L 3	NETMS
KT	<b>Calibration coefficient KT</b>	L 6	CFFKT
KS	<b>Calibration coefficient KS</b>	L 5	CFFKS
KR	<b>Calibration coefficient KR</b>	L5	CFFKR



Menu	Description	Password level / BCP command	
DAC1 4mA	<b>DAC1 out 4mA calibration point</b> <ul style="list-style-type: none"> <li>Current output 1 (4 mA)</li> <li>Calibration point 1 (zero flow rate)</li> </ul>	L5	C1CP1
DAC1 20mA	<b>DAC1 out 20mA calibration point</b> <ul style="list-style-type: none"> <li>Current output 1 (20 mA)</li> <li>Calibration point 2 (maximum flow rate)</li> </ul>	L5	C1CP2
FW update	<b>Firmware update</b> If the function is activated, the firmware can be uploaded to the SD card ( <code>name.file</code> ). The BCP interface is activated with the command <code>FWUPD = name.file</code>	L 4	FWUPD

### 7.6.12.1 System menu - additional BCP commands

The following menus are also available as an BCP command in the command input of the BCP software:

Menu	Description	Password level / BCP command	
Device Unique Identity KEY	<b>Device unique identity key</b>	L 0	UIKEY
Device hardware configuration	<b>Device hardware configuration</b>	L 0	HWSET
Device hardware code	<b>Device hardware code</b>	L 0	HWCOD
Calibr.execution status memory	<b>Calibr.execution status</b> This function checks the internal calibration status of the sensor. <ul style="list-style-type: none"> <li><code>CALXM = 1</code> valid calibration This is the default value to avoid calibrations that are not required.</li> <li><code>CAKXM = 0</code> invalid calibration If the function is zero, the calibration function must be started with the <code>CALIC</code> BCP command.</li> </ul>	L 6	CALXM
Select the function code	<b>Selection of the function code</b>	L 0	FCODS
Select the enable state of func.	<b>Selection of the function release</b>	L 6	FNESS





Menu	Description	Password level / BCP command	
Select enable state of ALL func.	<b>Selection of function release of all functions</b>	L 6	AFNSS
Select fun.for quick start menu	<b>Selection of function release of functions of the quick start menu</b>	L 6	QSFNS
Select ALL fun.for quick.s.menu	<b>Selection of function release of all functions quick start menus</b>	L 6	QSLST
List quick start group functions	<b>List of released functions of the quick start menu</b>	L 6	QSLST
List enable status of functions	<b>List of unlocked features</b>	L 6	FSLST
Access code	<b>Access code</b> Enter the access code for the BCP commands	L 0	ACODE
Terminate the PPP data link	<b>Termination of the PPP traffic</b>	L 0	LTERM
Quit the MCPI connection	<b>Termination of the BCPI connection</b>	L 0	MQUIT
List all available functions	<b>List of all functions</b>	L 0	FLIST
List all function (compr.mode)	<b>Compressed list of all functions</b>	L 0	FLISC
Select menu for functions list	<b>Selection menu for function list</b>	L 0	FMSEL
List parameters configuration	<b>List for internal parameters</b>	L 0	CFLST
Totaliz.T+ value set	<b>Setting the value of the positive total counter</b>	L 4	VTTPS
Totaliz.P+ value set	<b>Setting the value of the positive part counter</b>	L 4	VTPPS
Totaliz.T- value set	<b>Setting the value of the negative total counter</b>	L 4	VTNS
Totaliz.P- value set	<b>Setting the value of the negative part counter</b>	L 4	VTPNS
Totaliz.T+ overflow value set	<b>Setting the overflow value of the positive total counter</b>	L 4	VTPOS
Totaliz.P+ overflow value set	<b>Setting the overflow value of the positive part counter</b>	L 4	VPPOS
Totaliz.T- overflow value set	<b>Setting the overflow value of the negative total counter</b>	L 4	VTNOS

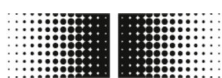

Menu	Description	Password level / BCP command	
Totaliz.P- overflow value set	<b>Setting the overflow value of the negative part counter</b>	L 4	VPNOS
CPU max.recorded temperature	<b>Maximum recorded CPU temperature</b>	L 6	CPUMX
CPU min.recorded temperature	<b>Low recorded CPU temperature</b>	L 6	CPUMN
Calibration offset register 0	<b>Calibration offset register 0</b>	L 6	COFR0
Calibration gain register 0	<b>Calibration gain register 0</b>	L 6	CGAR0
Calibration gain register 1	<b>Calibration gain register 1</b>	L 6	CGAR1
Calibration gain register C	<b>Calibration gain register C</b>	L 6	CGARC

## 7.6.13 Process data menu

The following menus are only available as an BCP command in the command input of the BCP software:

Menu	Description	Password level / BCP command	
Set value for Digital output 1	<b>Setting the value for the Digital output 1</b>	L 0	OUT1S
Set value for Digital output 2	<b>Setting the value for the Digital output 2</b>	L 0	OUT2S
F.rate f.scale in chosen units	<b>Flow rate / scale end value in selected unit of measure</b>	L 0	FRFSN
Flow rate value in percentage	<b>Flow in percent</b>	L 0	FRVPC
F.rate in perc.without cut-off	<b>Flow in percent without cut-off</b>	L 0	FRVPX
F.rate in binary.without cut-off	<b>Flow in binary representation without cut-off</b>	L 0	FRVBX
F.rate value in unit of measure	<b>Flow rate in selected unit of measure</b>	L 0	FRVTU
Totaliz.T+ read value	<b>Reading out the positive total counter</b>	L 0	VTPPV



Menu	Description	Password level / BCP command	
Totaliz.P+ read value	<b>Reading the positive part counter</b>	L 0	VTPPV
Totaliz.T- read value	<b>Reading the negative total counter</b>	L 0	VTTNV
Totaliz.P- read value	<b>Reading the negative part counter</b>	L 0	VTPNV
Totaliz.T+ number of overflows	<b>Total number of positive total counter overflows</b>	L 0	VTTPO
Totaliz.P+ number of overflows	<b>Total number of positive part counter overflows</b>	L 0	VTPPO
Totaliz.T- number of overflows	<b>Total number of negative total counter overflows</b>	L 0	VTTNO
Totaliz.P- number of overflows	<b>Total number of overflows of the negative sub-counter</b>	L 0	VTPNO
Temperature T1 value	<b>T1 temperature value</b>	L 0	T1VUM
Temperature T1 value percentage	<b>T1 temperature value in percent</b>	L 0	T1VPC
CPU temperature	<b>CPU temperature</b>	L 0	CPUTP
Liquid velocity	<b>Flow velocity</b>	L 0	LQVEL
N.of samples for averaged values	<b>Number of values for average</b>	L 0	AVGSN
Active alarm(s) status	<b>Active alarm status</b>	L 0	ALARM
Sensor test result code	<b>Sensor test result</b>	L 0	STSRC
Equivalent input resistance	<b>Equivalent input resistance</b>	L 0	INRES
Electrodes input voltages	<b>Electrodes input voltage</b>	L 0	INVLS
Sequence number	<b>Sequence number</b>	L 0	SEQNB

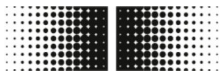

## 8 Maintenance

The flow sensor PF55S does not require maintenance.

No special maintenance activities are required.

Regular cleaning and regular review of the plug connections are recommended.

### 8.1 External cleaning

During external cleaning of the flow sensor PF55S care must be taken that the cleaning agent used does not come into contact with the housing surface and seals.



#### **NOTICE!**

##### **Property damage due to improper cleaning**

Unsuitable cleaning agents and methods can result in leaks on the flow sensor, at the seals or connections and thus in property damage.

- Always use a cleaning agent with a flash point above 55 °C.
- Always check that the cleaning agent is suitable for cleaning the surfaces that require cleaning.
- Never use abrasives, solvents or other aggressive cleaning agents for cleaning.
- Never clean using a jet of liquid, e.g. pressure washer.
- Never scratch off dirt using sharp objects.

### 8.2 Internal cleaning

No internal cleaning of the flow sensor PF55S is provided for.

### 8.3 Replacing the seals

The seals between the flow sensor PF55S and piping system (especially aseptic form seals) must be replaced periodically.

The interval between replacements depends on the frequency of the cleaning times and on the medium and cleaning temperature.

The service intervals for the seals must therefore be determined by the operator.

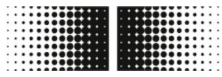

## 9 Fault elimination

The flow sensor monitors itself during operation.

When faults occur, they are displayed in the visualization `alarm` message:

↳ 9.1 "Alarms" on page 93

When diagnostics are run in the `Diagnostic` menu, error messages are generated:

↳ 9.2 "Error messages" on page 95

### Conduct with regard to faults



#### WARNING!

Risk of injury due to improper troubleshooting

The following always applies:

1. In the event of faults that pose an immediate danger to people or material assets, bring the PF55S into a safe state immediately.
2. Also observe the information regarding faults in the operation manual for the higher-level machine.
3. Identifying the cause of the fault.
4. If work in the danger zone is required in order to eliminate the fault, deactivate the PF55S and ensure that it cannot be switched back on.

Inform those responsible at the site about the fault immediately.

5. Depending on the type of fault, either have it eliminated by authorized specialist personnel or rectify it yourself.

### 9.1 Alarms

Message	Cause	Troubleshooting
NO ALARMS	No error	—
[000] SYSTEM RESTART	Restart the software	—
[001] INTERNAL PS FAIL	Internal power supply error	Contact Service.
[005] F-RAM ERROR	Error writing or reading the internal memory	Contact Service.
[006] EXCITATION ERROR	Error in controlling the sensor coils	Check the cable connections of the sensor.

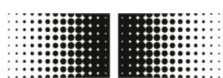

Message	Cause	Troubleshooting
[007] SIGNAL ERROR	The measurement is heavily influenced by external interference or the connection cable is damaged.	<ul style="list-style-type: none"> <li>■ Check the cable connections.</li> <li>■ Check ground connections.</li> <li>■ Eliminate possible sources of interference.</li> </ul>
[008] PIPE EMPTY	The measuring pipe is empty or the sensor has not been properly calibrated.	<ul style="list-style-type: none"> <li>■ Check the fill level of the measuring tube.</li> <li>■ Check the empty calibration of the sensor.</li> </ul>
[009] FLOW>MAX+	The flow rate is higher than the set maximum positive threshold value.	<ul style="list-style-type: none"> <li>■ Check process conditions.</li> <li>■ Check the set maximum threshold for the positive flow rate in the <i>Scales</i> menu.</li> </ul>
[010] FLOW>MAX-	The flow rate is higher than the set negative maximum threshold.	<ul style="list-style-type: none"> <li>■ Check process conditions.</li> <li>■ Check the set maximum threshold for the negative flow rate in the <i>Scales</i> menu.</li> </ul>
[011] FLOW<MIN+	The flow rate is lower than the set minimum positive threshold.	<ul style="list-style-type: none"> <li>■ Check process conditions.</li> <li>■ Check the set minimum positive flow rate threshold in the <i>Scales</i> menu.</li> </ul>
[012] FLOW<MIN-	The flow rate is lower than the set minimum negative threshold.	<ul style="list-style-type: none"> <li>■ Check process conditions.</li> <li>■ Check the set minimum negative flow rate threshold in the <i>Scales</i> menu.</li> </ul>
[013] FLOW>FULL SCALE +	The flow rate is higher than the set positive scale end value.	<ul style="list-style-type: none"> <li>■ Check process conditions.</li> <li>■ Check the set maximum value for the positive flow rate in the <i>Scales</i> menu.</li> </ul>
[014] FLOW>FULL SCALE-	The flow rate is lower than the set negative scale end value.	<ul style="list-style-type: none"> <li>■ Check process conditions.</li> <li>■ Check the maximum negative flow rate set in the <i>Scales</i> menu.</li> </ul>
[015] PULSE1>RANGE	The pulse generator of the Output 1 of the sensor can not generate the sufficient number of pulses.	<ul style="list-style-type: none"> <li>■ Increase set value for volume unit in the <i>Units</i> menu.</li> <li>or</li> <li>■ Reduce the set interval for pulse generation in the <i>Scales</i> menu.</li> </ul>
[016] PULSE2> RANGE	The pulse generator of the Output 2 of the sensor can not generate the sufficient number of pulses.	<ul style="list-style-type: none"> <li>■ Increase set value for volume unit in the <i>Units</i> menu.</li> <li>or</li> <li>■ Reduce the set interval for pulse generation in the <i>Scales</i> menu</li> </ul>
[017] CALIBR.ERROR	Calibration error	Contact Service.

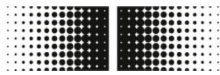

Message	Cause	Troubleshooting
[018] SYSTEM FREQ.ERR	System frequency error	Contact Service.
[019] B.DATA NOT INIT	Uninitialized data system	Contact Service.
[020] FL.SENSOR ERROR	Sensor error flow rate	Contact Service.
[024] MAIN PS V.ERR	Void beyond the tolerance range	Contact Service.
[025] USB VOLTAGE ERR	Voltage of USB port out of tolerance	Contact Service.

## 9.2 Error messages

The error messages are displayed in a code based on the hexadecimal system. For each digit an error meaning is deposited. For this reason, multiple error combinations are possible. The error combinations are displayed in the numerical code.

Code	Cause	Troubleshooting
0000	No error	—
0001	Sensor insulator test: Generator power too low	Contact Service.
0002	Sensor insulator test: Generator power too high	Contact Service.
0004	Sensor insulator test: Phase 1 generator voltage too low	Contact Service.
0008	Sensor insulator test: Generator voltage of phase 1 too high	Contact Service.
0010	Sensor insulator test: Phase 1 terminal voltage coil 1 too low	Contact Service.
0020	Sensor insulator test: Terminal voltage coil 2 of phase 1 too low	Contact Service.
0040	Sensor insulator test: Phase 2 generator voltage too low	Contact Service.
0080	Sensor insulator test: Phase 2 generator voltage too high	Contact Service.
0100	Sensor insulator test: Terminal voltage coil 2 of phase 1 too low	Contact Service.

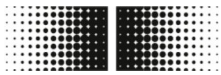

Code	Cause	Troubleshooting
0200	Sensor insulator test: Terminal voltage coil 2 of phase 1 too low	Contact Service.
0400	Sensor insulator test: Insulation loss, out of tolerance flow	<ul style="list-style-type: none"><li>■ Check wiring between sensor and transmitter.</li><li>■ Check process conditions.</li><li>■ Check the settings of the sensor.</li></ul>
0800	Test temperature (resistance) coils: Temperature (resistance) out of tolerance	
1000	Test time for the current phase (A): Test time out of tolerance	
2000	Test time for the current phase (B): Test time out of tolerance	
4000	Test Resistance Inputs Electrodes (A): Value out of tolerance	
8000	Test Resistance Inputs Electrodes (B): Value out of tolerance	



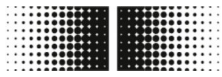

### 10 Disassembly and disposal

When disposing of the products, the applicable country-specific waste disposal regulations apply.



#### **ENVIRONMENT!**

#### **Risk to the environment due to incorrect disposal**

Incorrect disposal can result in risks to the environment.

- Always dispose of the flow sensor in an eco-friendly manner.
- Always observe the locally applicable disposal regulations. Instruct a specialist company to undertake disposal, if necessary.

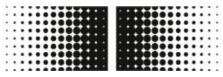

## 11 Technical data

Dimensions for flow sensor with  
DN 10 to 20

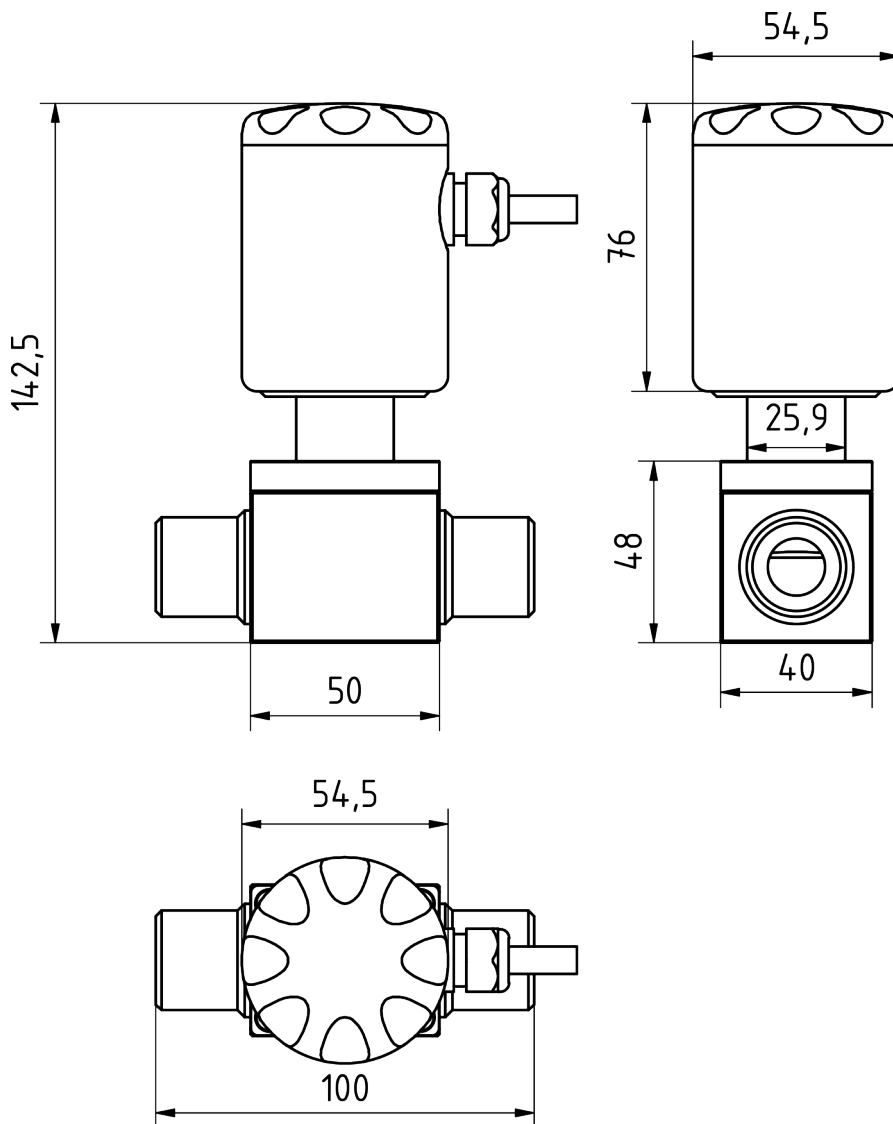
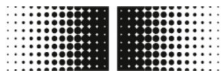

Fig. 8: Dimension sheet in mm

DN	Ports	A	H
10	1/2 "	—	—
15	3/4 "	—	—
20	1 "	—	—



### Dimensions for flow sensor with DN 25 to 50

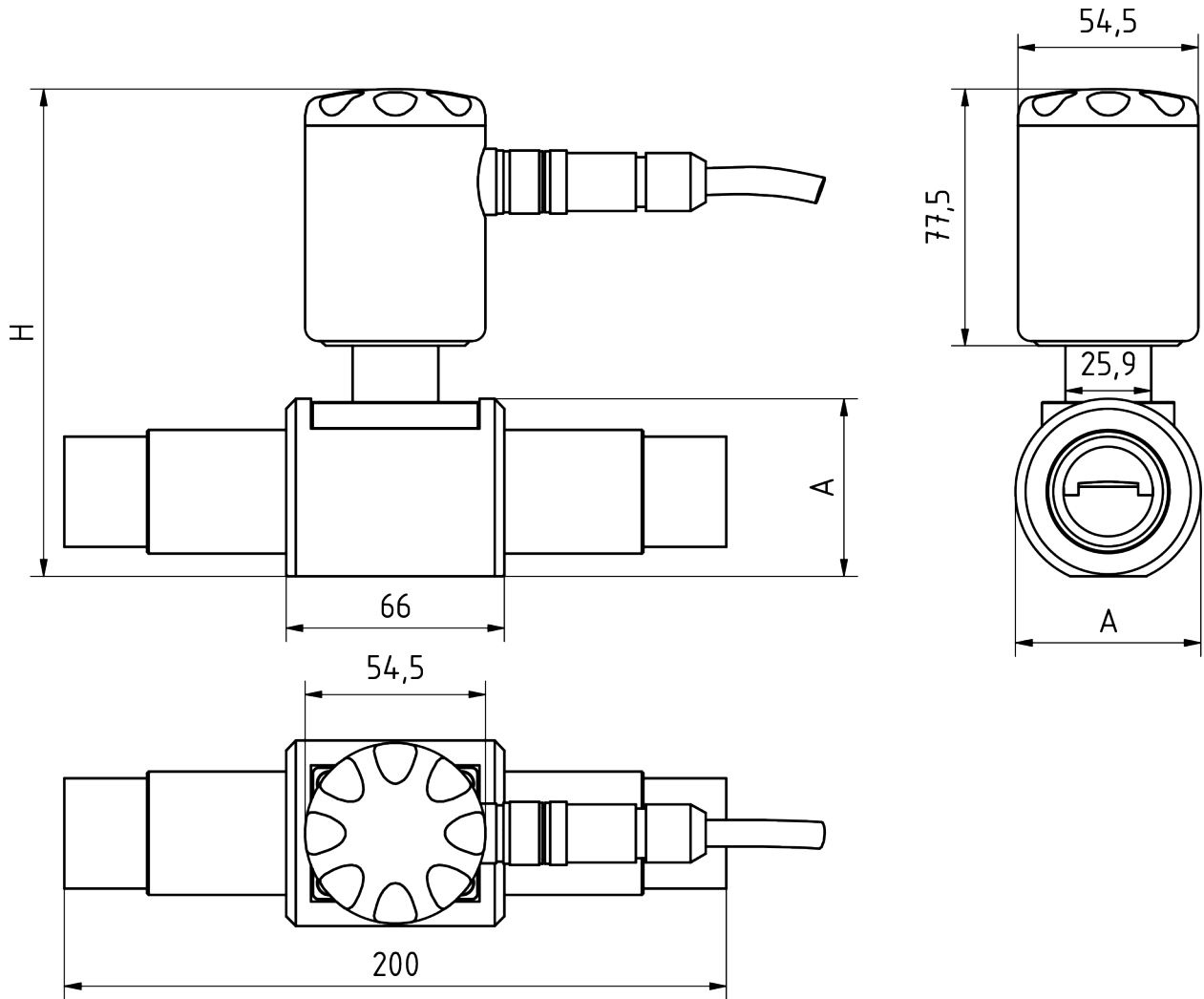
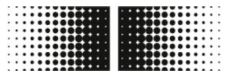

Fig. 9: Dimension sheet in mm

DN	Ports	A	H
25	1 "	56 mm	148 mm
32	1 1/4 "	56 mm	148 mm
40	1 1/2 "	62 mm	156 mm
50	2 "	69 mm	164 mm

### Operating conditions

Data	Value	Unit
Ambient temperature	-10 – 100	°C



Data	Value	Unit
	14 – 212	°F
Height above sea level	-200 – 2000	m
	-656 – 6560	ft
Relative humidity, maximum, non-condensing	0 – 100	%
Pressure, maximum	16	bar
Temperature of the fluids	-20 – 100	°C
	-4 – 212	°F

### Technical data

This flow sensor complies with the Pressure Equipment Directive (PED) and is designed and manufactured as per the state of the art for media in fluid group 2.

Data	Value	Unit
IP protection class	IP67	—
Conductibility of the fluids, minimum	50	μS/cm
Viscosity of the fluids at 40 °C, maximum	70	mm <sup>2</sup> /s
Viscosity of the fluids at 104 °F, maximum	70	cST

### Supply data, electrical

Data	Value	Unit
Power supply (± 10 %)	10 – 30	V <sub>DC</sub>
Power consumption, maximum	1	W
Output, isolated	500	V
Number of switch outputs	2	—
Load output 4 (20 mA at 30 V), maximum	500	Ω

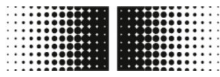

### Type plate

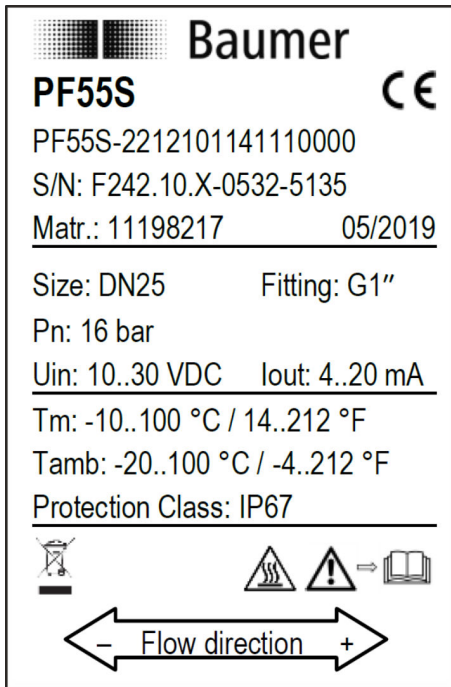

The type plate is located on the transmitter of the control unit and contains the following information:

- Manufacturer
- Type
- Serial number
- Date of manufacture
- Technical data
- CE mark
- Identification of the flow direction

Fig. 10: Sample illustration

**12 Replacement parts**

For mounting parts and other accessories, see [www.baumer.com](http://www.baumer.com).

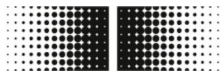

## 13 Index

### A

Access codes	
Software	53
Alarms	
PF55S	93
Alarms menu	
Software	71

### B

BCP command input	
PF55S	50
BCP Software	
PF55S	47
BCP software installation	
PF55S	42

### C

Commissioning	
PF55S	41
Communication menu	
Software	79
Configuration files	
PF55S	49
Contamination	22
Control software BCP	
PF55S	28
Copyright protection	4
Create USB interface	
PF55S	41

### D

Delivery	29
Description	
PF55S	26
Designated use	
PF55S	10
Diagnostic menu	
Software	82
Dimensions and weight	
PF55S DN 10 to 20	98
PF55S DN 25 to 50	99
Display menu	
Software	80
Disposal	
PF55S	97

### E

Electrical accident	15
Electrical connection	
PF55S	38
Error messages	
PF55S	95

External cleaning	
PF55S	92

### F

Fault	
PF55S	93
Faults	24
Functional principle	
PF55S	26
Functions menu	
Software	81

### H

Hazard zones	10
--------------	----

### I

Immediate measures following an electrical accident	15
Improper assembly	20
Improper maintenance	23
Improper troubleshooting	24
Inputs menu	
Software	73
Installation	20
PF55S	31, 35
Installation position of the flow sensor	
PF55S	32
Installation positions to be avoided	
PF55S	34
Integrator	13
Internal cleaning	
PF55S	92

### M

Main menu	
Software	58
Maintenance	23
PF55S	92
Marking	
Safety	11
Measure menu	
Software	68
Menu navigation	
Quick start menu	53
Software	58
Misuse	
PF55S	10

### O

Operating company's obligations	11
Operation	
PF55S	47



Operation: Example		Technical data . . . . .	99
Software . . . . .	54	Ports	
Operation: Example main menu		PF55S . . . . .	27
Software . . . . .	56	Prerequisites for installation	
Operation: Example quick start menu		PF55S . . . . .	31
Software . . . . .	54	Protective equipment . . . . .	18
Other applicable documents . . . . .	3		
Outputs menu		<b>Q</b>	
Software . . . . .	75	Qualifications . . . . .	16
Overview		Quick start	
PF55S . . . . .	7	Software . . . . .	53
Owner . . . . .	11	Quick start menu	
		Menu navigation . . . . .	53
<b>P</b>		Software . . . . .	53
Packaging			
disposal . . . . .	29	<b>R</b>	
Personal protective equipment . . . . .	18	Recommended installation position	
Personnel . . . . .	16	PF55S . . . . .	32
PF55S		Replacement parts . . . . .	24
Alarms . . . . .	93	Invalidation of the warranty . . . . .	25
BCP command input . . . . .	50	PF55S . . . . .	102
BCP Software . . . . .	47	Reference . . . . .	25
BCP software installation . . . . .	42	Replacing the seals	
Commissioning . . . . .	41	PF55S . . . . .	92
Configuration files . . . . .	49		
Control software BCP . . . . .	28	<b>S</b>	
Create USB interface . . . . .	41	Safety marking . . . . .	11
Description . . . . .	26	Scales menu	
Designated use . . . . .	10	Software . . . . .	66
Disposal . . . . .	97	Sensor menu	
Electrical connection . . . . .	38	Software . . . . .	60
Error messages . . . . .	95	Signs . . . . .	11
External cleaning . . . . .	92	Software	
Fault . . . . .	93	Access codes . . . . .	53
Functional principle . . . . .	26	Alarms menu . . . . .	71
Installation . . . . .	31, 35	Communication menu . . . . .	79
Installation position of the flow sensor . . . . .	32	Diagnostic menu . . . . .	82
Installation positions to be avoided . . . . .	34	Display menu . . . . .	80
Internal cleaning . . . . .	92	Functions menu . . . . .	81
Maintenance . . . . .	92	Inputs menu . . . . .	73
Misuse . . . . .	10	Main menu . . . . .	58
Operation . . . . .	47	Measure menu . . . . .	68
Overview . . . . .	7	Menu navigation . . . . .	58
Ports . . . . .	27	Operation: Example . . . . .	54
Prerequisites for installation . . . . .	31	Operation: Example main menu . . . . .	56
Recommended installation position . . . . .	32	Operation: Example quick start menu . . . . .	54
Replacement parts . . . . .	102	Outputs menu . . . . .	75
Replacing the seals . . . . .	92	Quick start . . . . .	53
Structure . . . . .	26	Quick start menu . . . . .	53
Transport . . . . .	29	Scales menu . . . . .	66
Visualization view . . . . .	50	Sensor menu . . . . .	60
PF55S DN 10 to 20		System menu . . . . .	87
Dimensions and weight . . . . .	98	Units menu . . . . .	62
Technical data . . . . .	98	Storage . . . . .	29
PF55S DN 25 to 50		Structure	
Dimensions and weight . . . . .	99	PF55S . . . . .	26



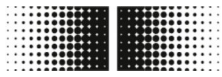

Symbols	
in the manual . . . . .	8
System menu	
Software . . . . .	87
<b>T</b>	
Technical data	
PF55S DN 10 to 20 . . . . .	98
PF55S DN 25 to 50 . . . . .	99
Technical limitations . . . . .	10
Weakest component . . . . .	10
Training . . . . .	18
Transport	
PF55S . . . . .	29
Transport inspection . . . . .	29
<b>U</b>	
Units menu	
Software . . . . .	62
<b>V</b>	
Visualization view	
PF55S . . . . .	50
<b>W</b>	
Weakest component	
Technical limitations . . . . .	10
Working range . . . . .	10