

OHDK 25G6911

Diffuse sensors with background suppression - standard

Article number: 11079949

Overview

- background suppression
- 100 ... 1750 mm
- pulsed red laser diode
- push-pull
- Teach-in
- cable, 2 m
- 50 °C
- IP 67



Picture similar



Technical data

General data

Type	Background suppression
Light source	Pulsed red laser diode
Sensing distance Tw	100 ... 1750 mm
Sensing range Tb	100 ... 1750 mm
Power on indication	LED green
Light indicator	LED yellow
Sensing distance adjustment	Teach-in
Laser class	1
Wave length	656 nm
Beam diameter	3.7 ... 22 mm
Black/white shift	0%

Electrical data

Response time / release time	< 10 ms
Voltage supply range +Vs	10 ... 30 VDC
Current consumption max. (no load)	80 mA
Voltage drop Vd	< 3.5 VDC

Electrical data

Output function	Light / dark operate
Output circuit	Push-pull
Output current	< 100 mA
Number of outputs	1
Short circuit protection	Yes
Reverse polarity protection	Yes

Mechanical data

Width / diameter	23.4 mm
Height / length	63 mm
Depth	45 mm
Type	Rectangular
Housing material	Plastic (SAN LURAN 378P)
Front (optics)	PMMA
Connection types	Cable, L=2 m

Ambient conditions

Protection class	IP 67
Operating temperature	0 ... +50 °C
Storage temperature	-10 ... +70 °C

Remarks

- qTeach

OHDK 25G6911

Diffuse sensors with background suppression - standard

Article number: 11079949

Dimension drawing

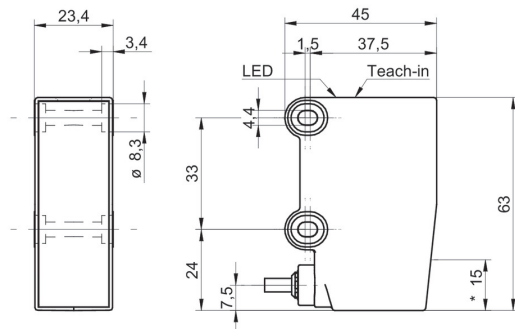

- * emitter axis

Laser warning

**CLASS 1 LASER
PRODUCT**

IEC 60825-1/2014

Complies with 21 CFR 1040.10 and 1040.11 except for conformance with IEC 60825-1 Ed. 3., as described in Laser Notice No. 56, dated May 8, 2019

Connection diagram

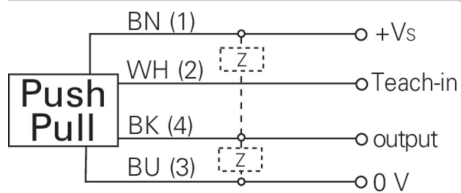

Switching point

