

Overview

- 18 mm
- NPN complementary (NO / NC)
- connector M12
- -25 ... 75 °C
- IP 67



Picture similar



Technical data

General data

Mounting type	Flush
Special type	Enhanced distance (GammaProx)
Nominal sensing distance Sn	18 mm
Temperature drift	± 10 %
Hysteresis	3 ... 20 % of Sr
Output indicator	3 port LED red
Correction factor typ.	Mild steel 100 %, stainless steel 70 %, aluminum 40 %

Electrical data

Switching frequency	500 Hz
Voltage supply range +Vs	6 ... 36 VDC
Current consumption max. (no load)	10 mA
Output circuit	NPN complementary (NO / NC)

Electrical data

Voltage drop Vd	< 2 VDC
Output current	< 200 mA
Short circuit protection	Yes
Reverse polarity protection	Yes

Mechanical data

Type	Cylindrical threaded
Material (sensing face)	PBT
Housing material	Brass nickel plated
Dimension	30 mm
Housing length	60 mm
Connection types	Connector M12
Tightening torque max.	140 Nm

Ambient conditions

Operating temperature	-25 ... +75 °C
Protection class	IP 67

Remarks

- Increased sensing distance
- Complementary output

Dimension drawing

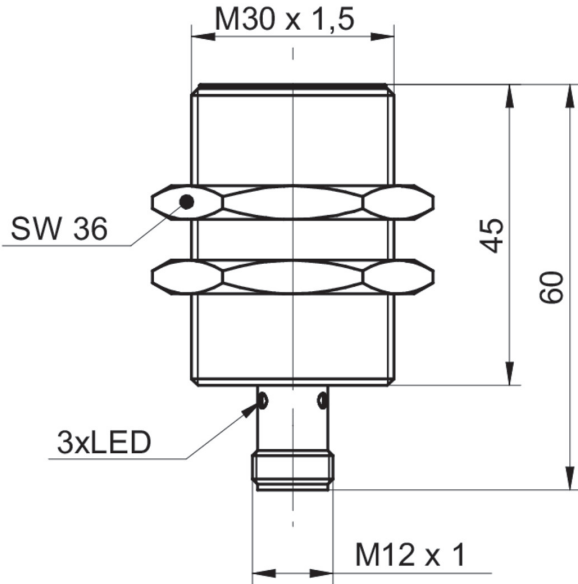

Connection diagram

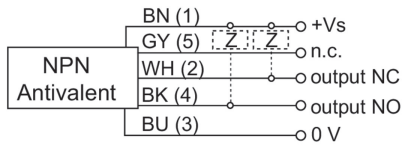

Correction factors for different mounting situation (approx.)

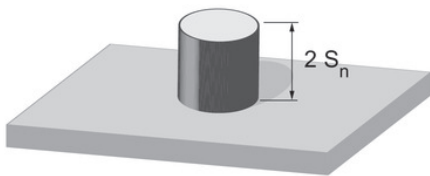

Mounting material	Correction factor
Mild steel	100 %
Stainless steel	100 %
Aluminum	100 %

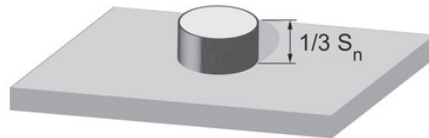

Mounting material	Correction factor
Mild steel	105 %
Stainless steel	105 %
Aluminum	100 %

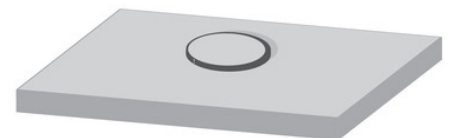

Mounting material	Correction factor
Mild steel	not possible
Stainless steel	not possible
Aluminum	75 %

Mounting instructions

