

Overview

- 10 mm
- PNP break function (NC)
- cable, 2 m
- -25 ... 75 °C
- IP 67



Picture similar



Technical data

General data

Mounting type	Non-flush
Special type	Enhanced distance (GammaProx)
Nominal sensing distance S _n	10 mm
Temperature drift	± 10 % (0 ... +60 °C) ± 15 % (-25 ... +75 °C)
Hysteresis	3 ... 20 % of S _r
Output indicator	LED red
Correction factor typ.	Mild steel 100 %, stainless steel 75 %, aluminum 50 %

Electrical data

Switching frequency	1.5 kHz
Voltage supply range +Vs	6 ... 36 VDC
Current consumption max. (no load)	10 mA
Output circuit	PNP break function (NC)

Electrical data

Voltage drop V _d	< 2 VDC
Output current	< 100 mA
Short circuit protection	Yes
Reverse polarity protection	Yes

Mechanical data

Type	Cylindrical threaded
Material (sensing face)	PBT
Housing material	Brass nickel plated
Dimension	12 mm
Housing length	40 mm
Connection types	Cable, L=2 m
Tightening torque max.	15 Nm (A: 10 Nm)

Ambient conditions

Operating temperature	-25 ... +75 °C
Protection class	IP 67

Remarks

- Increased sensing distance

Dimension drawing

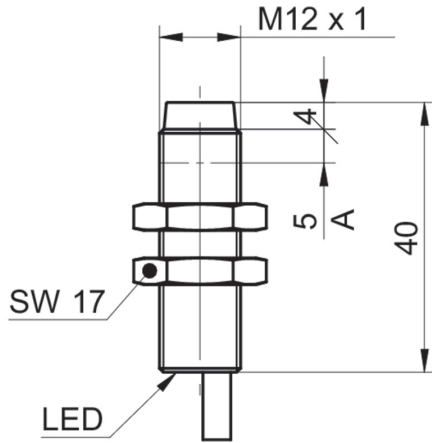

Connection diagram



Correction factors for different mounting situation (approx.)

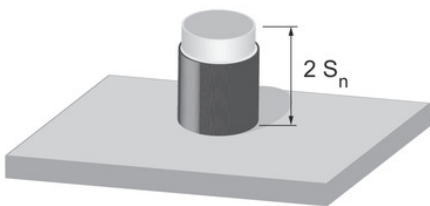

Mounting material	Correction factor
Mild steel	100 %
Stainless steel	100 %
Aluminum	100 %

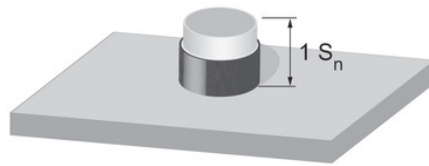

Mounting material	Correction factor
Mild steel	105 %
Stainless steel	100 %
Aluminum	100 %

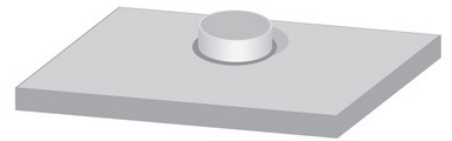

Mounting material	Correction factor
Mild steel	not possible
Stainless steel	not possible
Aluminum	90 %

Mounting instructions

