

IFRD 08N17A1/S35L

Inductive sensors special versions

Article number: 10150429

Overview

- 2 mm
- NPN make function (NO)
- connector M8
- -25 ... 75 °C
- IP 68/67 (sensing face/sensor)



Picture similar



Technical data

General data

Mounting type	Quasi-flush
Special type	Full metal housing (<kursiv>Duro-Prox</kursiv>)
Nominal sensing distance S _n	2 mm
Hysteresis	2 ... 20 % of S _r
Output indicator	3 port LED red

Electrical data

Switching frequency	150 Hz
Voltage supply range +V _s	10 ... 30 VDC
Current consumption max. (no load)	20 mA
Output circuit	NPN make function (NO)
Voltage drop V _d	< 2 VDC

Electrical data

Output current	< 200 mA
Short circuit protection	Yes
Reverse polarity protection	Yes

Mechanical data

Type	Cylindrical threaded
Material (sensing face)	Stainless steel 1.4404 (V4A)
Housing material	Stainless steel 1.4404 (V4A)
Operating pressure static	< 20 bar
Dimension	8 mm
Housing length	46 mm
Connection types	Connector M8

Ambient conditions

Operating temperature	-25 ... +75 °C
Protection class	IP 68/67 (sensing face/sensor)

Remarks

- Higher noise immunity (EMC), (EN 61000-6-2)

IFRD 08N17A1/S35L

Dimension drawing

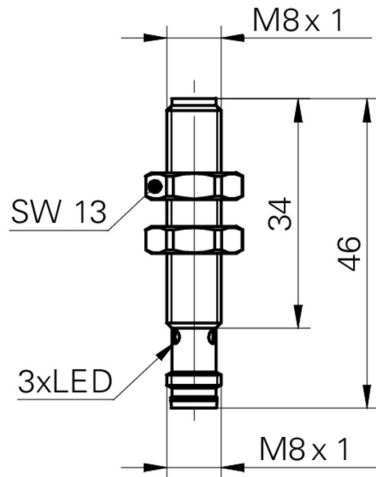

Connection diagram

