

FUF 025B1011

Glass fiber optic cable

Article number: 10217076

Overview

- Diffuse type
- Sensing distance up to 110 mm
- Threaded sensing head M4
- Metal jacket 25 cm long
- Operating temperature up to +250 °C
- For rugged fiber optic sensors FVDM 15



Picture similar

Technical data

General data

Operating principle	Diffuse type
Sensing distance Tw	110 mm
Fiber optic head	Cylindrical threaded
Operating temperature	-25 ... +250 °C
Exit angle	60°
Fiber optics can be shortened to length	No
Integrated lens	No
Adaptable lens	No
Infrared light compatibility (1450 nm)	Yes

Mechanical data

Width / diameter (head)	4 mm
Height / length (head)	26 mm
Material (head)	Brass
Thread	M4 x 0.7
Bending radius (fixed)	15 mm
Bending radius (mobile)	30 mm
Cable jacket diameter	5 mm
Material cable jacket	Brass chromium plated
Fiber cross section	2 mm ²
Material (fiber optic cable)	Glass
Length (fiber optic cable)	25 cm

Dimension drawing

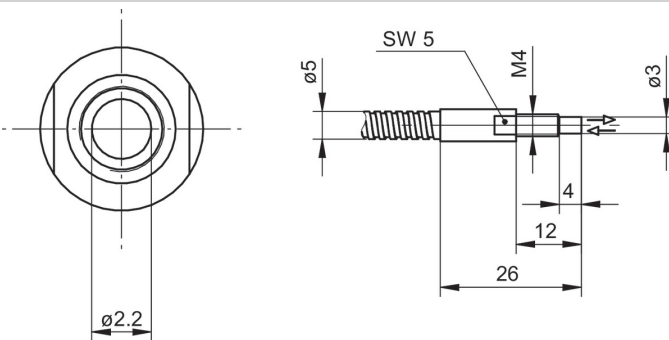

Fiber arrangement

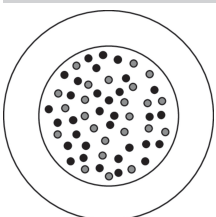

Accessories**Fitting fiber optic sensors**

10234639	FVDM 15N5103
10122368	FVDM 15N5103/S14
10234520	FVDM 15P5103
10239451	FVDM 15P5103/S14
10234519	FVDM 15P5130
10124952	FVDM 15P5130/S14

Mounting accessories

10103230	Replacement cap nut for fiber optics series 15
----------	--