

Manual

Absolute encoder with EtherNet/IP (with bus cover)

Firmware Version 1.01 and up

Content	Page
1. Introduction	4
1.1. Scope of delivery	4
1.2. Product allocation	4
2. Safety precautions and operating instructions	5
3. Bus cover – functional principle	6
4. Device profile	7
4.1. Introduction	7
4.2. Object model	8
4.3. Identity Object – 01hex	9
4.4. Position Sensor Object – 23hex	12
4.5. Assembly Object – 04hex	17
4.6. Assembly Instances	18
4.7. Parameter Object – 0Fhex	20
5. EtherNet/IP-specific objects	24
5.1. Introduction	24
5.2. Ethernet Link Object – F6hex	25
5.3. TCP/IP Interface Object – F5hex	27
6. Commissioning	31
6.1. Mechanical mounting	31
6.2. Electrical connection	31
6.2.1. Cabling	31
6.2.2. Connecting the bus cover	32
6.3. Operating display (multi-colour LED)	34
6.4. Activity display (green LEDs)	34
7. IP address allocation	35
7.1. EtherNet/IP bus cover with HEX rotary switches: IP-assignment after Power On	35
7.2. Allocate IP address with BOOTP/DHCP configuration tool	36
7.3. RSLinx Classic Lite	37
7.4. RSWho	37
8. Device configuration	38
8.1. Introduction	38
8.2. Using the parameter object	38
8.3. Application of the configuration assembly instance 105	41
8.4. Direct application of the position sensor object	43
9. RSLogix5000 project example	45
9.1. Reading in the input data	45
9.1.1. Configure Generic Ethernet Module	46
9.2. Explicit Messaging, PLC Program Example, Set Preset	48
9.2.1. Create program tags	48
9.2.2. Create Controller Tags	49
9.2.3. Configuration of the message tag	50
10. Used abbreviations and terms	51
11. FAQ's	51
11.1. Device not responding / IP address unknown	51

Disclaimer of liability

The present manual was compiled with utmost care, errors and omissions reserved. For this reason Baumer rejects any liability for the information compiled in the present manual.

Baumer nor the author will accept any liability for direct or indirect damages resulting from the use of the present information.

At any time we should be pleased receiving your comments and proposals for further enhancement of the present manual.

Created by:

Baumer Germany GmbH & Co. KG

Bodenseeallee 7

DE-78333 Stockach

www.baumer.com

Registered Trademarks

RSLinX™, RSNetWorX™ und RSLogix5000™ are registered trademarks of Rockwell Automation. The EtherNet/IP logo is a registered trademark of ODVA, Inc. This and other trademarks referred to in the present manual which at the same time might be registered trademarks bear no corresponding mark. Having omitted the respective mark does not necessarily implicate the conclusion of a free brand name, nor does it refer to any existing patents and protected patented designs.

1. Introduction

1.1. Scope of delivery

Please check the delivery upon completeness prior to commissioning.

Depending on encoder configuration and part number delivery is including:

Basic encoder, bus cover and CD with describing file and manual (also available as download)

1.2. Product allocation

Product mechanics Solid / Hollow shaft / Kit	E-IP Product-Code	EDS-File	Description
BMMV / BMMH / BMMK	32	Baumer_EIP_Encoder_BMMx_24l.eds	MT, <i>MAGRES</i>
BMSV / BMSH / BMSK	33	Baumer_EIP_Encoder_BMSx_24l.eds	ST, <i>MAGRES</i>
GBMMW / GBMMS / GBMMH	34	Baumer_EIP_Encoder_GBMMx_8EA2.eds	MT, Optical, 18 bit ST
GBAMW / GBAMS / GBAMH	35	Baumer_EIP_Encoder_GBAMx_8EA2.eds	ST, Optical, 18 bit ST
GXMMW / GXMMS / G0MMH	30	Baumer_EIP_Encoder_GXMMx_8EA2.eds	MT, Optical, 13 bit ST
GXAMW / GXAMS / G0AMH	31	Baumer_EIP_Encoder_GXAMx_8EA2.eds	ST, Optical, 13 bit ST

Explanation:

MT Multiturn encoder

ST Singleturn encoder

MAGRES Extremely robust encoder with magnetic sensing principle

18 Bit ST High resolution encoder – up to 18 bit physical singleturn resolution, i.e. 2^{18} steps / revolution

13 Bit ST Max. 13 bit physical singleturn resolution, i.e. 2^{13} steps / revolution

2. Safety and operating instructions

Intended use

- The encoder is a precision measuring device that is used to record positions and speeds. It provides measuring values as electronic output signals for the subsequently connected device. It must not be used for any other purpose. Unless this product is specially labeled, it may not be used for operation in potentially explosive environments.
- Make sure by appropriate safety measures, that in case of error or failure of the encoder, no danger to persons or damage to the system or operating facilities occurs.

Personnel qualification

- Installation and assembly of this product may be performed only by a person qualified in electronics and precision mechanics.

Maintenance

- The encoder is maintenance-free and must not be opened up nor mechanically or electronically modified. Opening up the encoder can lead to injury.

Disposal

- The encoder contains electronic components. At its disposal, local environmental guidelines must be followed.

Mounting

- Solid shaft: Do not connect encoder shaft and drive shaft rigidly. Connect drive and encoder shaft with a suitable coupling.
- Hollow shaft: Open clamping ring completely before mounting the encoder. Foreign objects must be kept at a sufficient distance from the stator coupling. The stator coupling is not allowed to have any contact to the encoder or the machine except at the mounting points.

Electrical commissioning

- Do not proceed any electrical modifications at the encoder.
- Do not proceed any wiring work while encoder is live.
- Do not remove or plug on connector whilst under power supply.
- Ensure that the entire system is installed in line with EMC/EMI requirements. Operating environment and wiring have an impact on the electromagnetic compatibility of the encoder. Install encoder and supply cables separately or far away from sources with high emitted interference (frequency converters, contactors, etc.).
- When working with consumers with high emitted interference provide separate encoder supply voltage.
- Completely shield encoder housing and connecting cables.
- Connect encoder to protective earth (PE) using shielded cables. The braided shield must be connected to the cable gland or connector. Ideally, aim at dual connection to protective earth (PE), i.e. housing by mechanical assembly and cable shield by the downstream devices.

Supplementary information

- The present manual is intended as a supplement to already existing documentation (e.g. catalogues, data sheets or mounting instructions).

3. Bus cover – functional principle

The product family architecture is modular. Depending on what is required from the encoder, the basic encoder and bus covers can be combined at will with the selected bus system.

The basic encoders differ in terms of accuracy, ambient conditions and the utilized sensing principle.

Bus cover

The bus cover accommodates the entire electronics for measured value processing and for Ethernet communication.

The bus covers differ by the respectively integrated bus interface.

Available bus interfaces: CANopen®, DeviceNet, EtherCAT, Ethernet/IP, Profibus-DP, Profinet, Powerlink, Power over EtherCAT, SAE J1939, SSI.

All encoders enable parameterization by bus interface.

Functional principle:

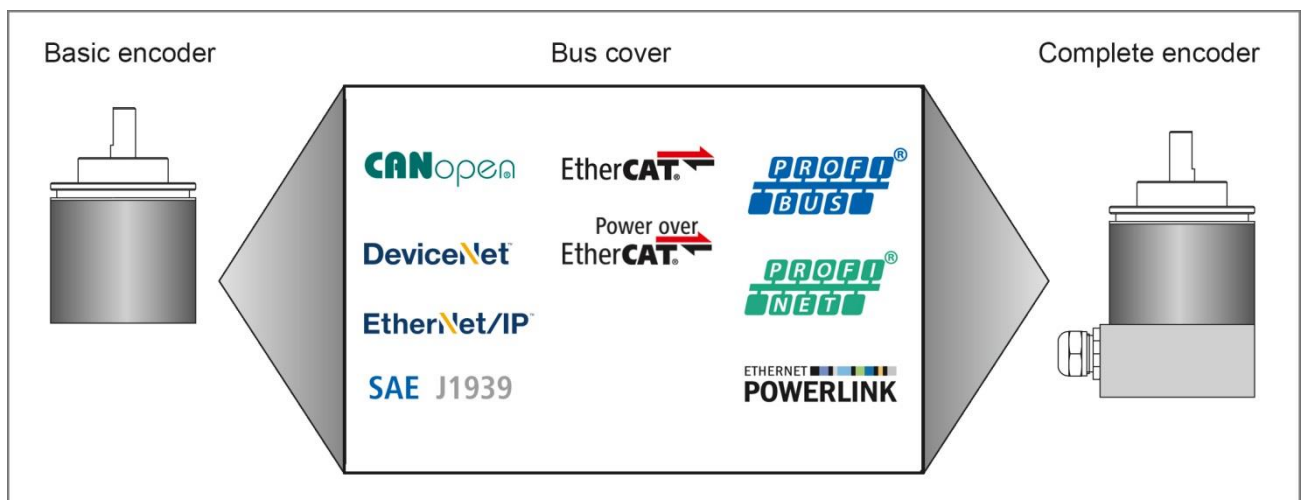

4. Device profile

4.1. Introduction

As an application layer, EtherNet/IP uses the Common Industrial Protocol (CIP) released by the ODVA. CIP is transmitted as an “encapsulated” protocol in the data section of standard Ethernet frames. Depending on the assignment and type of connection, the data transmission mechanisms UDP/IP or TCP/IP are used.

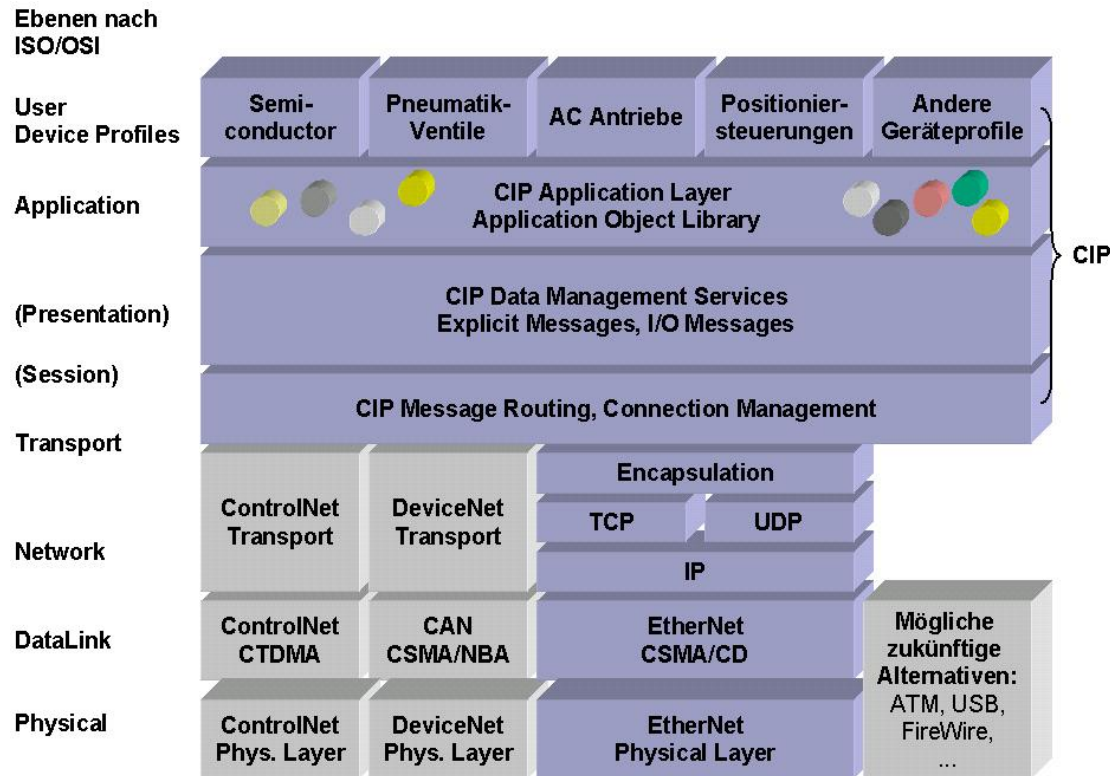

Fig. 1: EtherNet/IP and CIP levels in accordance with the OSI reference model

CIP is an object-oriented protocol. The device characteristics are described by objects (such as a parameter object) which have one or more instances. Each instance in turn has one or more attributes. Attributes describe individual characteristics of objects (such as parameter value or parameter unit).

In device profiles, the ODVA defines which CIP objects and attributes have to be supported by a certain device class. In addition, optional and manufacturer-defined objects and attributes are also possible.

Baumer encoders with Baumer EtherNet/IP bus cover support the Encoder Device Profile, device type 22 hex in accordance with the “Common Industrial Protocol Specification”, Volume 1 of the ODVA, Edition 3.7, November 2009.

Data transmission of CIP messages in EtherNet/IP networks takes place by means of implicit and explicit messages.

Typically, implicit messages are smaller data packages for time-critical data transmissions. When transmitting I/O data, implicit connections with long-term viability are generally involved. I/O data is transmitted by means of UDP and uses port 2222.

Non time-critical data is transmitted by means of explicit messages. Examples of explicit messages are configuration or information data, which use the TCP/IP transmission mechanism.

More detailed information on the Common Industrial Protocol (CIP) or on EtherNet/IP can be obtained from the ODVA (www.odva.org).

4.2. Object model

The object model describes the used object classes of the encoder and their mutual relationship. This is defined in the 22Hex device profile of the ODVA for encoder devices and depicted in the diagram below. Objects made available by the Baumer bus cover but which are only an optional component of the device profile are shaded in grey in this diagram.

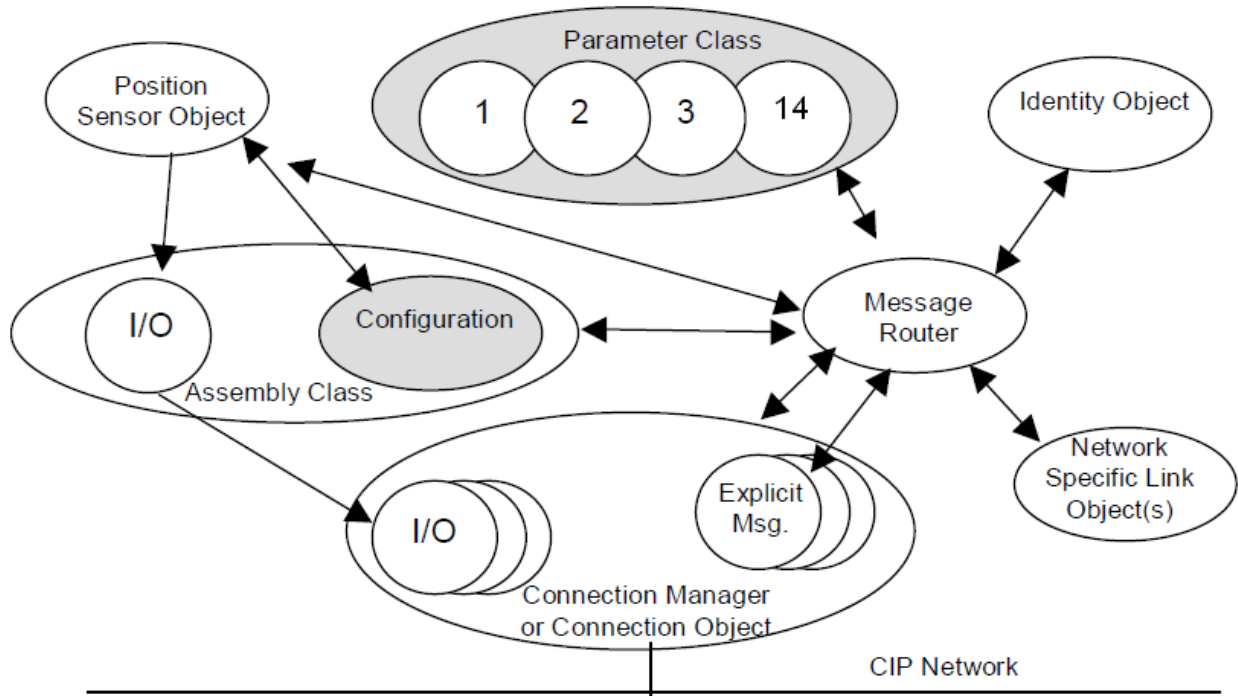

Fig. 2: Object model of the encoder device profile as a component of the Baumer bus cover

The following table indicates the object classes and the number of instances available in each class.

Object class	Number of instances
01h: Identity Object	1
02h: Message Router Object	1
04h: Assembly Object	6, the instances present are 1, 2, 3, 100, 105, 110
06h: Connection Manager Object	1
0Fh: Parameter Object	14
23h: Position Sensor Object	1
F4h: Port Object	2
F5h: TCP/IP Interface Object	1
F6h: Ethernet Link Object	3

Table 3: Available objects

The characteristics of these objects are described in the following sections and/or the relevant EDS file.

4.3. Identity Object – 01hex

The identity object is implemented in accordance with the Common Industrial Protocol Specification. The object revision is 1, and the class code is 01h.

Table 4 lists the available class attributes. Class attributes are addressed via instance 0.

For the class attributes of the identity object, the services

- 01h Get Attribute all
 - 0Eh Get Attribute single
- are supported.

Attribute ID	Access	Name	Data type	Description	Values
1	read	Revision	UINT	Object revision	1
2	read	Max Instance	UINT	Highest instance number existing in this class	1
3	read	Number of Instances	UINT	Number of existing instances	1
4	read	Optional attribute list	STRUCT of	List of supported optional instance attributes	
		number of attributes	UINT	Number of supported optional instance attributes	2
		optional attributes	ARRAY of UINT	Number of optional instance attribute numbers	11, 12
6	read	Maximum ID Number Class Attributes	UINT	Attribute number of last class attribute	7
7	read	Maximum ID Number Instance Attributes	UINT	Attribute number of last instance attribute	12

Table 4: Class attributes of the identity object

The table below contains all supported instance attributes of the identity object.

Attribute ID	Access	Name	Data type	Description	Values
1	read	Vendor ID	UINT	Manufacturer identification	468 = Baumer Vendor ID
2	read	Device Type	UINT	Product type identification (device profile)	34 = 22hex
3	read	Product Code	UINT	Identification of a manufacturer's part product	
4	read	Revision	STRUCT of	Product revision	
		Major Revision	USINT		
		Minor Revision	USINT		
5	read	Status	WORD	Summarized device status (see description below the table)	
6	read	Serial Number	UDINT	Device serial number	
7	read	Product Name	SHORT_STRING	Readable product identification	
11	read / write	Active Language	STRUCT of	Language currently supported by the device	Based on ISO 639-2/T) STRINGI Data type
			USINT	Field 1 of STRINGI type	
			USINT	Field 2 of STRINGI type	
			USINT	Field 3 of STRINGI type	
12	read	Supported Language List	ARRAY of STRUCT of	List of supported languages as field of individual elements as described in attribute 11	
			USINT	Field 1 of STRINGI type	
			USINT	Field 2 of STRINGI type	
			USINT	Field 3 of STRINGI type	

Table 5: Identity object, instance attributes

The status attribute (attribute number 5) is defined as a bit string. The meanings of the individual bits are described in Table 6.

Bit(s)	Name	meaning
0	Owned	= 1: at least 1 object of the device has an owner. The bit is set if at least a class 1 or a class 3 connection is in the "established status".
1		Reserved, value = 0
2	Configured	= 1: at least 1 application attribute has been changed as against the default settings. The bit is set if at least 1 writable attribute of the position sensor object has been changed.
3		Reserved, value = 0
4-7	Extended Device Status	= 0000: Self test = 0001: Firmware update is active = 0010: At least 1 I/O connection is in Error status (timeout detected) = 0011: There are no I/O connections in the Established status. This bit refers to Class 1 connections. = 0100: The saved configuration is defective. This bit is set if errors are detected when reading the data saved in the internal flash. = 0101: A serious error has been detected. Bit 10 or Bit 11 is additionally set = 0110: There is at least 1 I/O connection in the Run status (active). The bit refers to Class 1 connections. = 0111: There is at least 1 I/O connection in the Established status, but all connections are in the Idle Mode. Display of this status is not supported. All other bit combinations are reserved for manufacturer-defined information. These bit combinations are not used.
8	Minor Recoverable Fault	The device has detected a non-serious and reparable fault. This bit is set if a class 1 I/O connection has detected a timeout.
9	Minor Unrecoverable Fault	This fault category is not supported by the device.
10	Major Recoverable Fault	This bit is set if - an error is detected when reading the internal flash memory - an inadmissible jump of the position value has occurred (Position Error).
11	Major Unrecoverable Fault	This bit is set if no connected base encoder is detected when switching on the bus cover.
12-15		Reserved, value = 0

Table 6: Status attribute description

For the instance attributes of the identity object, the following services are supported:

- 01h Get Attribute all
- 05h Reset Service

The parameter values 0 and 1 are supported. After completed service, both parameter values bring about a reset of all connection configurations. No reset of application parameters to factory default takes place!

- 0Eh Get Attribute single
- 10h Set Attribute single

4.4. Position Sensor Object – 23hex

The position sensor object is implemented in accordance with the Common Industrial Protocol Specification. The object revision is 2 and the class code is 23h.

In Table 7 the available class attributes are listed. Class attributes are addressed via the instance 0.

For the class attributes of the position sensor object, the services
 - 0Eh Get Attribute single
 are supported.

Attribute ID	Access	Name	Data type	Description	Values
1	read	Revision	UINT	Object revision	2
2	read	Max Instance	UINT	Highest instance number existing in this class	1
3	read	Number of Instances	UINT	Number of existing instances	1
4	read	Optional Attribute List	STRUCT of	List of supported optional instance attributes	
		Number of Attributes	UINT	Number of supported optional instance attributes	18
		Optional Attributes	ARRAY of UINT	Number of optional instance attribute numbers	1,2, 11, 16, 17, 19, 24, 42, 43, 44, 45, 46, 47, 48, 49, 51,100, 101
6	read	Maximum ID Number Class Attributes	UINT	Attribute number of last class attribute	7
7	read	Maximum ID Number Instance Attributes	UINT	Attribute number of last instance attribute	101

Table 7: Class attributes of the position sensor object

The following table contains all supported instance attributes of the position sensor object. For a detailed description of individual instance attributes, see the table.

Attribute ID	Access	Name	Data type	Description	Values
1	read	Number of Attributes	USINT	Number of supported attributes	20
2	read	Attribute List	Array of USINT	List of supported attributes	1,2, 10, 11, 12, 16, 17, 19, 24, 42, 43, 44, 45, 46, 47, 48, 49, 51,100, 101
10	read	Position Value Signed	DINT	Current position value	
11	read	Position Sensor Type	UINT	Specifies the sensor type	
12	read / write	Direction Counting Toggle	BOOL	Defines the sense of rotation in which the position value rises.	CW = 0 CCW = 1
16	read/ write	Measuring Units per Span	UDINT	Number of required measuring units per revolution	
17	read/ write	Total Measuring Range in Measuring Units	UDINT	Number of required measuring units over the entire measuring range	
19	read / write	Preset Value	DINT	Position value is set to the reset value	
24	read	Velocity Value	DINT	Current speed value	
42	read	Physical Resolution Span	UDINT	Number of maximum distinguishable measuring units per revolution	
43	read	Number of Spans	UINT	Maximum number of revolutions	
44	read	Alarms	WORD	Indicates a detected error which can result in an incorrect position value or requires user intervention	
45	read	Supported Alarms	WORD	Information on supported alarms	
46	read	Alarm Flag	BOOL	Indicates whether an alarm has occurred.	
47	read	Warnings	WORD	Indicates any existing warnings	
48	read	Supported Warnings	WORD	Information about supported warnings	
49	read	Warning Flag	BOOL	Indicates if a warning is active	
51	read	Offset Value	DINT	The offset is calculated with the preset function. The actually measured position is displaced by this value.	
100	Read / write	Velocity Sample Rate	USINT	Velocity sample rate in ms	1..255
101	Read / write	Velocity Filter	USINT	Number of samples for calculating moving average value	1..255

Table 8: Position sensor object, instance attributes

Position Value Signed – attribute 10

Absolute position of the sensor. Zero correction of the preset function is taken into consideration in the displayed value. The unit of measurement for the position value is increments or scanning steps or counts.

Position Sensor Type – attribute 11

Depending on the used base encoder, one of the following values is displayed:

01 – Singleturn absolute encoder

02 – Multiturn absolute encoder

Direction Counting Toggle – attribute 12

Behaviour of the position data depending on the sense of rotation of the encoder when rotating the encoder shaft seen looking at the flange.

Setting CW (clockwise) = rising values when rotating clockwise

Setting CCW (counterclockwise) = rising values when rotating counterclockwise

The parameter value is saved in a non-volatile memory in case of changes.

Measuring Units per Span – attribute 16

The attribute defines the number of distinguishable steps per revolution of the sensor.

The value is an indication of the required single turn resolution (“measuring units per revolution”).

Values between 1 and the maximum resolution of the encoder per revolution (attribute 42) are admissible.

Reparameterization can result in a change of attribute 17 to the value of the equations (1) or (2), if the value of attribute 17 is smaller than the minimum value or greater than the maximum value.

Reparameterization deletes the previous offset value (attribute 51), so that the previous position reference is lost. The parameter value is saved in a non-volatile memory in the event of a change.

Total Measuring Range in Measuring Units – attribute 17

This attribute defines the total number of distinguishable steps over the entire measurement range.

The minimum setting value is calculated as:

$$\text{Minimum value attr. 17} = \text{Set value attr. 16} \quad (1)$$

The maximum setting value is calculated as:

$$\text{Maximum value attr. 17} = \text{Set value attr. 16} \times \text{value attr. 43} \quad (2)$$

If the number of revolutions is programmed to a value unequal to 2^n (1, 2, 4, - 65536) then after traversing the sensor zero in a de-energized status, reparameterization must be carried out.

The number of counted revolutions is calculated as:

$$\text{Number of counted revolutions} = \text{Set value attr. 17} \div \text{Set value attr. 16} \quad (3)$$

Reparameterization deletes the previous offset value (attribute 51), so that the previous position reference is lost. The parameter value is stored in a non-volatile memory in the event of a change.

Preset value – attribute 19**Offset value – attribute 51**

The preset function supports adjustment of the encoder zero at the mechanical zero point of the system. In the event of a “set attribute” at attribute 19, the current position of the encoder is set to the preset value. The internal offset value (attribute 51) is calculated and stored in the encoder.

The following rule applies:

$$\text{Preset value (attribute 19)} = \text{position value (attribute 10)} + \text{offset value (attribute 51)} \quad (4)$$

Note: The preset function should only be used when the encoder is at a standstill.

A preset must always be carried out after the following attributes have been changed:

- Measuring units per span – attribute 16,
- Total measuring range in measuring units – attribute 17

When carrying out the preset function, an offset value (attribute 51) is internally calculated and stored as a non-volatile value in the flash memory, ensuring that the encoder retains the same unchanged position after switching off and back on. The flash memory is typically rewritable 100,000 times. However, despite the high number of possible write cycles, frequent program or event-controlled setting of the preset could foreshorten

the service life. When configuring the control software, a certain amount of care is consequently called for here. The preset can be selected in a range between zero and a value smaller than the set overall measurement range (attribute 17).

Velocity Value – attribute 24

The current velocity value of the encoder. The velocity value is read out in the unit “counted scanning steps / second”.

Physical Resolution Span – attribute 42

Using this attribute, the physical resolution of the encoder can be read out in the form of scanning steps per revolution.

Number of Spans – attribute 43

Maximum number of distinguishable revolutions. The physical measurement range is made up of:

Physical measurement range = attribute 42 (Physical Resolution Span) x attribute 43 (Number of Spans) (5)

Alarms – attribute 44**Supported Alarms – attribute 45****Alarm Flag – attribute 46**

Attribute 44 delivers alarm messages. An alarm is set if the encoder has detected a status which can result in an incorrect encoder position. As soon as an alarm status is detected, the relevant bit is set to logical high. The alarm is automatically reset after 5 seconds. The alarm flag (attribute 46) is also set with each alarm.

The following alarms are supported:

0001 - Bit 0: Position error

0002 - Bit 1: Diagnostic error

1000 - Bit 12: Illegal jump detected in the position value. (Jump between 2 position values corresponds to an inadmissible velocity of more than 6200 revolutions/minute)

4000 - Bit 14: Flash error (unable to read saved data)

8000 - Bit 15: No encoder is detected

The alarm messages of bits 12, 14 and 15 are defined on a manufacturer-specific basis.

Warnings – attribute 47**Supported Warnings – attribute 48****Warning Flag – attribute 49**

Attribute 47 delivers warning messages. Warnings are signalled by the encoder if internal parameters of the encoder are out of tolerance. In contrast to alarm messages, warnings do not indicate an incorrect position. Warnings are reset as soon as the parameter which was out of tolerance is restored to the correct value. The warning flag (attribute 49) is also set with each warning.

The following warnings are supported:

0010 - Bit 4: Battery voltage is low. Battery exchange is recommended.

2000 – Bit 13: The encoder is operating with default settings. No valid encoder data was found in the flash.

The warning message of bit 13 is defined on a manufacturer-specific basis.

Velocity Sample Rate – attribute 100

Min Value: 1 Max Value: 255 Default Value: 1

Time in ms between two measuring samples (delta Steps and delta Time)

Velocity Filter – attribute 101

Min Value: 1 Max Value: 255 Default Value: 1

Number of sampled values for calculating moving average value

The position sensor object supports the following instance services:

Code	Service	Description
0Eh	Get_Attribute_Single	Supplies the content of a selected attribute
10h	Set_Attribute_Single	Changes the value of a selected attribute. If the value can be stored, it is filed in the non-volatile memory.

Table 9: Position sensor object supported attribute services

Note: Attributes with “write” access rights are stored as non-volatile data immediately subject to valid write access.

Product	Measuring Units per Span			Number of Spans			Total Measuring Range in Measuring Units		
	Decimal	Hex	Bit	Decimal	Hex	Bit	Decimal	Hex	Bit
BMSx	16384	4000	14	1	1	0	16384	4000	14
BMMx	16384	4000	14	65536	10000	16	1073741824	40000000	30
GXAMx, G0AMx	8192	2000	13	1	1	0	8192	2000	13
GXMMx, G0MMx	8192	2000	13	65536	10000	16	536870912	20000000	29
GBAMx	262144	40000	18	1	1	0	262144	40000	18
GBMMx	262144	40000	18	8192	2000	13	2147483648	80000000	31

Table 9a: Encoder resolution default

Product configurations of the same product family come with identical default settings.

4.5. Assembly Object – 04hex

The assembly object is created in accordance with the Common Industrial Protocol Specification. The object revision is 2. The class code is 04h.

The provided class attributes are listed in table 10. Class attributes are addressed via the instance 0. All instances of the assembly object are static instances. Dynamic instances are not supported.

The service

- 0Eh Get Attribute single

can be applied on the class attributes of the assembly object.

Attribute ID	Access	Name	Data type	Description	Values
1	read	Revision	UINT	Object revision	2
2	read	Max Instance	UINT	Highest instance number existing in this class	110
3	read	Number of Instances	UINT	Number of existing instances	6
4	read	Optional attribute list	STRUCT of	List of supported optional instance attributes	
		number of attributes	UINT	Number of supported optional instance attributes	1
		optional attributes	ARRAY of UINT	List of optional instance attribute numbers	4
6	read	Maximum ID Number Class Attributes	UINT	Attribute number of last class attribute	7
7	read	Maximum ID Number Instance Attributes	UINT	Attribute number of last instance attribute	4

Table 10: Class attributes of the assembly object

The following table contains all supported instance attributes of the assembly object.

Attribute ID	Access	Name	Data type	Description	Values
3	read	Data	ARRAY of BYTE	Data of the assembly instance	
4	read	Size	UINT	Number of bytes in attribute 3	See table 13

Table 11: Assembly object, instance attribute

The service

- 0Eh Get Attribute single

can be applied on the instance attributes of the assembly object.

4.6. Assembly Instances

The encoder supports 6 I/O assembly instances.

I/O assembly instances are also called connection points. A distinction is made between the following connection point types:

- Originator -> Target (O->T). These connection points represent output assembly instances for the encoder from the viewpoint of the network.
- Target -> Originator (T->O). These connection points represent input assembly instances for the encoder from the viewpoint of the network. These instances contain for instance the position value of the encoder.

For cyclical reading of the encoder input data, from the viewpoint of an EtherNet/IP scanner, the following connection types can be used:

- **Exclusive owner uses O->T connection point 100. (max. 1 simultaneous connection is allowed).**
- **Input Only, uses the O->T connection point 254.**
- **Listen Only, uses the O->T connection point 255.**
The requirement for construction of listen-only connections is that at least 1 exclusive owner or one input only connection exists for the required T->O connection point.

The encoder supports up to 128 simultaneous connections. These connections can be implemented as class 1 or class 3 connections.

Note Instance class 1 connections can only be generated to one input assembly simultaneously.

According to the Encoder Device Profile, assembly instances 1, 2 and 3 are provided for input data. The input data of the Baumer-defined assembly instances 110 can also be used.

The object instance 105 is defined as the configuration assembly instance. Use of this assembly instance when establishing class 1 connections is one possibility for configuration of the encoder (see also section 8, Device configuration).

The output assembly instance 100 is implemented for use in exclusive owner connections.

The following table compiles all assembly instances defined in the encoder.

Instance	Typ	Name	Size /Byte
1	Input	Position Value	4
2	Input	Position Value & Warning Flag	5
3	Input	Position Value & Velocity	8
110	Input	Vendor specific: Pos,Velocity,Warning,Alarm	9
100	Output	EIPScan	0
105	Configuration	Configuration	10

Table 12: Baumer bus cover – assembly instances

The data formats of the assembly instances are listed in the table below.

Instance	Byte	Bit7	Bit6	Bit5	Bit4	Bit3	Bit2	Bit1	Bit0	Input Assembly Instances
1	0	Position LSB								
	1	Position								
	2	Position								
	3	Position MSB								
2	0	Position LSB								
	1	Position								
	2	Position								
	3	Position MSB								
	4							Warn Flag	Alarm Flag	
3	0	Position LSB								
	1	Position								
	2	Position								
	3	Position MSB								
	4	Velocity LSB								
	5	Velocity								
	6	Velocity								
	7	Velocity MSB								
110	0	Position value LSB								
	1	Position value								
	2	Positionswert								
	3	Positionswert MSB								
	4	Velocity LSB								
	5	Velocity								
	6	Velocity								
	7	Velocity MSB								
	8							Warn Flag	Alarm Flag	
Instance	Byte	Bit7	Bit6	Bit5	Bit4	Bit3	Bit2	Bit1	Bit0	Configuration Assembly Instance
105	0	Measuring Units per Span LSB								
	1	Measuring Units per Span								
	2	Measuring Units per Span								
	3	Measuring Units per Span MSB								
	4	Total Measuring Range LSB								
	5	Total Measuring Range								
	6	Total Measuring Range								
	7	Total Measuring Range MSB								
	8	Direction Counting Toggle								
	9	reserved								

Table 13: Assembly instance data formats.

4.7. Parameter Object – 0Fhex

The parameter object is implemented in compliance with the CIP Specification. The object revision is 1. The class code is 0Fh.

In Table 14, the provided class attributes are listed. Class attributes are addressed via instance 0.

The service
- 0Eh Get Attribute single
can be applied on the class attributes of the parameter object.

Attribute ID	Access	Name	Data type	Description	Values
1	read	Revision	UINT	Object revision	1
2	read	Max Instance	UINT	Highest instance number existing in this class	16
3	read	Number of Instances	UINT	Number of existing instances	16
4	read	Optional attribute list	STRUCT of	List of supported optional instance attributes	
		Number of attributes	UINT	Number of supported optional instance attributes	0
		Optional attributes	ARRAY of UINT	Number of optional instance attribute numbers	0
8	read	Parameter Class Descriptor	WORD	Bit information which describes the parameters	0x000B
9	read	Configuration Assembly Instance	UINT	Instance number of the configuration assembly instance	105

Table 14: Class attributes of the parameter object

The class attribute 8 Parameter Class Descriptor provide the following bit information:

Bit 0: = 1 A parameter object instance is available for each parameter.

Bit 1: = 1 Each parameter instance contains all attributes.

Bit 2: = 0 Automatic data saving upon writing of error-free response

Bit 3: = 1 Non-volatile saving of all parameters

The following table contains all supported instance attributes of the parameter object.

Attribute ID	Access	Name	Data type	Description	Values
1	read / write	Parameter Value	Defined in attributes 4, 5 and 6	Current value of the parameter. The attribute is read only if bit 4 of attribute 4 is set.	
2	read	Link Path Size	USINT	Size of the link path (attribute 3)	No. of bytes
3	read	Link Path	Packed EPATH	CIP path to object, instance and attribute from which the parameter value is received	
4	read	Descriptor	WORD	Description of parameter object instance characteristics	
5	read	Data Type	EPATH	Data type code	
6	read	Data Size	USINT	No. of bytes of the parameter value (attribute 1)	
7	read	Parameter Name String	SHORT STRING	ASCII string with prefixed length of the parameter name	
8	read	Units String	SHORT STRING	ASCII string with prefixed length of the parameter unit (00 if the parameter value has no unit)	
9	read	Help String	SHORT STRING	ASCII string with prefixed length of the help description	
10	read	Minimum Value	Defined in attributes 4, 5 and 6	Minimum value on which the parameter can be set	
11	read	Maximum Value	Defined in attributes 4, 5 and 6	Maximum value on which the parameter can be set	
12	read	Default Value	Defined in attributes 4, 5 and 6	Default value of the parameter if no change has been carried out	
13	read	Scaling Multiplier	UINT	Value for scaling factor	1
14	read	Scaling Divisor	UINT	Divisor for scaling calculation	1
15	read	Scaling Base	UINT	Basis for scaling calculation	1
16	read	Scaling Offset	INT	Offset for scaling formula	0
17	read	Multiplier Link	UINT	Parameter Instance of the multiplier value (0, if no parameter)	0
18	read	Divisor Link	UINT	Parameter instance of the divisor values (0, if no parameter)	0
19	read	Base Link	UINT	Parameter instance of the basis values (0, if no parameter)	0
20	read	Offset Link	UINT	Parameter instance of the offset values (0, if no parameter)	0
21	read	Decimal Precision	USINT	Specifies the number of decimal places where an integer value has to be interpreted with decimal places in the used unit.	0

Table 15: Parameter object, instance attribute

The services

- 01h Get Attribute all
- 0Eh Get Attribute single
- 10h Set Attribute single

can be used on the instance attributes of the parameter object

The following bits of the instance attribute 4, descriptor can be set in the parameter instances of the Baumer bus cover and have the following meaning:

Bit 4: The parameter value is read only and can only be read.

Bit 5: The parameter value is updated in real time by the device.

Note

Writable parameter values are saved as non-volatile data in the device after a successful write access. Writing to the internal flash takes place when the new parameter value is distinguished from the old one and is accepted by the system as valid.

By means of the scaling attributes (instance attributes 13 to 16 and 21), integer parameter values can be displayed in other formats. The following formula applies for calculation of the value to be depicted:

$$\text{Value to be depicted} = \frac{(\text{Actual Value (Attr. 1)} + \text{Offset (Attr. 16)}) \times \text{Mult (Attr. 13)} \times \text{Base (Attr. 15)}}{\text{Div (Attr. 14)} \times 10^{\text{Precision (Attr. 21)}}} \quad (6)$$

Note

In the current firmware, only the default units (C = Count for position values) and CPS = Counts per second for velocity values) are supported by the encoder. Consequently the formula (6) always results in: Value to be depicted = Actual value (attr. 1)

Parameter instances always contain attributes from instances of other objects (for path see parameter instance attribute 3) as a source. In table 16, the individual parameter instances are named with their sources and important characteristics.

The functional significance of the parameter values corresponds to the functional description of the respective instance attributes of the source objects and is described in the relevant sections of the manual.

Parameter instance	Source object	Source instance	Source attribute	Parameter name	Minimum value	Maximum value	Default value
1	Position Sensor Object	1	12	DirCountToggle	0	1	0
2	Position Sensor Object	1	16	MeasUnitsPerSpan	1	See table 9.a	See table 9.a
3	Position Sensor Object	1	17	TotMeasRangeinUn	See table 9.a	See table 9.a	See table 9.a
4	Position Sensor Object	1	19	PresetValue	0	Smaller than set overall measurement range (see parameter instance 3)	0
5	Position Sensor Object	1	10	PositionValue	0	Set overall measurement range (see parameter instance 3)	0
6	Position Sensor Object	1	42	PhysResolSpan	See table 9.a	See table 9.a	See table 9.a
7	Position Sensor Object	1	43	NumberOfSpan	See table 9.a	See table 9.a	See table 9.a
8	Position Sensor Object	1	46	AlarmFlag	0	1	0
9	Position Sensor Object (23h)	1	44	Alarms	0	D003hex	0
10	Position Sensor Object	1	45	SupportedAlarms	D003hex	D003hex	D003hex
11	Position Sensor Object	1	49	WarningFlag	0	1	0
12	Position Sensor Object (23h)	1	47	Warnings	0	2010hex	0
13	Position Sensor Object	1	48	SupportedWarnings	2010hex	2010hex	2010hex
14	Position Sensor Object	1	24	Velocity	0	FFFFFFFFhex	0
15	Position Sensor Object	1	100	Velocity Sample Rate	1	255	1
16	Position Sensor Object	1	101	Velocity Filter	1	255	1

Table 16: Parameter object instances - characteristics

5. EtherNet/IP-specific objects

5.1. Introduction

The Baumer bus cover has two physical Ethernet ports P1 and P2 with integrated switch technology. Both physical ports use a common MAC address and a common IP address. Both ports support autonegotiation and automatically set the duplex mode and the interface speed.

The EtherNet/IP-specific objects existing in the bus cover and their mutual relationships.

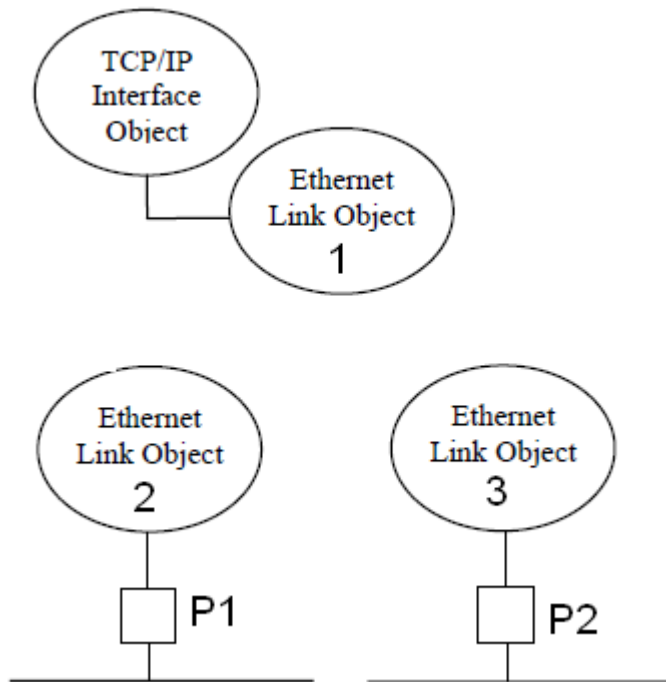

Fig. 3: Illustration of the existing EtherNet/IP-specific objects

Writing to the communication interface of the Baumer bus cover is carried out by an instance of the TCP / IP interface object and a total of 3 instances of the Ethernet link object.

Writing to the two physical Ethernet ports P1 and P2 is carried out by the instances 2 and 3 of the Ethernet link object. Instance 1 of the Ethernet link object is required for writing to the internal device port of the integrated switch.

5.2. Ethernet Link Object – F6hex

The Ethernet link object is created in accordance with the Common Industrial Protocol Specification. The object revision is 3. The class code is F6h.

In Table 17, the available class attributes are listed. Class attributes are addressed via the instance 0.

The services

- 01h Get Attribute all

- 0Eh Get Attribute single

can be applied on the class attributes of the Ethernet link object.

Attribute ID	Access	Name	Data type	Description	Values
1	read	Revision	UINT	Object revision	3
2	read	Max Instance	UINT	Highest instance number existing in this class	3
3	read	Number of Instances	UINT	Number of existing instances	3
4	read	Optional attribute list	STRUCT of	List of supported optional instance attributes	
		number of attributes	UINT	Number of supported optional instance attributes	3
		optional attributes	ARRAY of UINT	Number of optional instance attribute numbers	7, 8, 10
6	read	Maximum ID Number Class Attributes	UINT	Attribute number of last class attribute	7
7	read	Maximum ID Number Instance Attributes	UINT	Attribute number of last instance attribute	10

Table 17: Class attributes of the Ethernet link object

Instances of the Ethernet link Object

Instance	Significance
1	intern
2	Port P1
3	Port P2

Table 17.a: Instances of the Ethernet link Object

The following table contains all supported instances of the Ethernet link object.

Attribute ID	Access	Name	Data type	Description	Values
1	read	Interface Speed	UDINT	Current speed of the interface	
2	read	Interface Flags	DWORD	Interface status flags, see also the description below	
3	read	Physical Address	ARRAY of 6 USINT	MAC address	
7	read	Interface Type	USINT	Interface type, see also the description below	
8	read	Interface State	USINT	General interface status, see also the description below	
10	read	Interface Label	SHORT_STRING	Readable interface identification	

Table 18: Ethernet link object, instance attributes

Instance attribute 2 (interface flags) has the following meaning:

Bit 0:	Link Status:	= 1 Active link exists
Bit 1:	Half/Full Duplex:	= 0 Half duplex
		= 1 Full duplex
Bits 2-4:	Status Negotiation:	= 0 Auto negotiation in execution
		= 1 Error in auto negotiation and speed detection. Default values are used.
		= 2 Error in auto negotiation but speed detected. The default value for the duplex mode is used.
		= 3 Auto negotiation successfully completed. Duplex Mode and speed detected.
		= 4 Auto negotiation not completed. Values for speed and duplex mode forced.
Bit 5	Manual Settings required Reset:	= 0 The interface can automatically adopt changes of attributes of the Ethernet link objects and does not require a reset for activation
Bit 6:	Local Hardware Fault	= 0 No hardware error detected
		= 1 Hardware error detected
Bits 7-31: reserved		

The interface type (instance attribute 7) has the value 1 for internal interfaces (corresponds to instance 1 of the Baumer bus cover) or the value 2 (twisted pair interface for object instances 2 and 3).

The interface state attribute (instance attribute 8) has the following meaning:

0:	The interface status is unknown
1:	The interface is ready to transmit and receive data
2:	The interface is switched off
3:	The interface is in the test mode
4-256:	reserved

The services

- 0Eh Get Attribute single
- 01h Get Attribute all

can be applied on the instance attribute of the Ethernet link object.

5.3. TCP/IP Interface Object – F5hex

Das TCP/IP interface object is created in accordance with the CIP Specification. The object revision is 1. The class code is F5h.

In Table 19, the available class attributes are listed. Class attributes are addressed via the instance 0.

The services

- 0Eh Get Attribute single
- 01h Get Attribute all

can be applied on the class attributes of the Ethernet interface object.

Attribute ID	Access	Name	Data type	Description	Values
1	read	Revision	UINT	Object revision	1
2	read	Max Instance	UINT	Highest instance number existing in this class	1
3	read	Number of Instances	UINT	Number of existing instances	1
4	read	Optional attribute list	STRUCT of	List of supported optional instance attributes	
		number of attributes	UINT	Number of supported optional instance attributes	2
		optional attributes	ARRAY of UINT	List of optional instance attribute numbers	8, 9
6	read	Maximum ID Number Class Attributes	UINT	Attribute number of last class attribute	7
7	read	Maximum ID Number Instance Attributes	UINT	Attribute number of last instance attribute	9

Table 19: Class attributes of the TCP/IP interface object

The following table contains all supported instance attributes of the TCP/IP interface object.

Attribute ID	Access	Name	Data type	Description	Values
1	read	Status	DWORD	Interface status, see also the description below	
2	read	Configuration Capability	DWORD	Interface characteristics, see also the description below	14hex
3	read / write	Configuration Control	DWORD	Interface control flags, see also the description below	
4	read	Physical Link Object	STRUCT of	Path to the physical link object	Path to the Ethernet link object, instance 1
		Path size	UINT	Size of the path (number 16 bit words in the path)	2
		Path	Padded EPATH	Path	20 F6 24 01
5	read / write	Interface configuration	STRUCT of	TCP/IP network configuration	
		IP Address	UDINT	IP address of the device	
		Network Mask	UDINT	Network mask of the device	0 = No network mask configured
		Gateway Address	UDINT	Gateway address of the device	0 = no gateway address configured
		Name Server	UDINT	Primary name server of the device	0 = No primary name server configured
		Name Server 2	UDINT	Secondary name server of the device	0 = No secondary name server configured
6	read / write	Host Name	STRING	Host name of the device	ASCII characters, maximum length = 64 characters Is padded to an even number of characters
8	read / write	TTL Value	USINT	TTL (Time to live) value for EtherNet/IP multicast frames	

9	read	Mcast Config	STRUCT of	IP Multicast address configuration, see also description below	
		Alloc Control	USINT	Multicast address allocation control word, determines how addresses are allocated	
		reserved	USINT	ODVA, reserved for possible future upgrades	0
		Num Mcast	UINT	Number of IP multicast addresses allocated for EtherNet/IP	
		Mcast Start Addr	UDINT	Start address from which the multicast addresses are allocated (class D address)	

Table 20: TCP/IP interface object, instance attributes

Attribute 1 (status) has the following meaning:

- Bits 0 - 3: Interface configuration Status:**
- = 0:** *The interface configuration attribute (attribute 5) has not been configured.*
 - = 1:** *The interface configuration attribute (attribute 5) contains valid values taken from the BOOTP, DHCP or from the internal flash memory.*
 - = 2:** *The interface configuration attribute (attribute 5) contains valid values taken from the hardware settings (HEX Rotary-switches).*
 - = 3-15:** *reserved*
- Bit 4: Mcast Pending:**
- = 1** *This bit is set if the TTL value attribute (attribute 8) or the mcast config attribute (attribute 9) has been changed and is deleted on the next device start. The configuration changes carried out are stored in the device.*

Bits 5 – 31: reserved

Attribute 2 (configuration capability) has the following meaning:

The device returns the value 14hex, which means:

04 hex: *The bus cover has DHCP client functionality and can acquire the network configuration via DHCP.*

10 hex: *The interface configuration attribute is writable.*

Note

The device does not have a DNS client and does not transmit the host name in the DHCP request.

Using attribute 3 (configuration control) it is possible to set how the device acquires the initial setting of the interface configuration attribute (attribute 5). A change of attribute 3 (configuration control) without error message is immediately stored in the device's internal flash memory. The following values can be set:

- 0: The device reads its configuration from the internal flash memory or from Hardware-Rotary switches.**
- 2: The device acquires its configuration via DHCP (default setting).**

Note

When changing the attribute value from 2 to 0, the interface configuration setting (attribute 5) is also stored in the internal flash memory of the device. For this reason, the attribute value 0 is only accepted if the interface configuration (attribute 5) contains valid values at this point in time.

The value of alloc control as a component of the mcast config (attribute 9) has the following meaning:

- 0: For generation of the multicast addresses, the specified allocation algorithm is used. If this value is written, the values for Num Mcast and Mcast Start Addr of the Attribute in the set access must be transferred with 0.**
- 1: The multicast addresses are allocated in accordance with the value for Num Mcast and Mcast Start Addr of the attribute.**
- 2: Reserved**

The services

- 0Eh Get Attribute single
- 01h Get Attribute all
- 10h Set Attribute single
- 02h Set Attribute all

can be applied on the instance attributes TCP/IP interface object.

6. Commissioning

6.1. Mechanical mounting

Shaft encoders

- Mount the encoder with the help of the mounting holes and three screws (square flange: 4 screws) provided at the encoder flange. Observe thread diameter and depth.
- There is an alternative mounting option in any angular position by eccentric fixings, see under accessories.
- Connect drive shaft and encoder shaft by using an appropriate coupling. The shaft ends must not touch each other. The coupling must compensate temperature and mechanical tolerances. Observe the maximum permitted axial or radial shaft load. For appropriate couplings please refer to accessories.
- Tighten the mounting screws firmly.

Blind or through hollow shaft encoders

- Mounting by clamping ring
Prior to mounting the encoder open the clamping ring completely. Push encoder onto the drive shaft and tighten the clamping ring firmly.
- Adjusting element with rubber buffer
Push the encoder onto the drive shaft and insert the cylindrical pin into the adjusting element (customer-mounted) and the rubber buffer.
- Mounting angle
Push the encoder onto the drive shaft. Insert adjusting angle into the encoder's rubber buffer and fasten the mounting angle at the contact surface.
- Stud screw
Push the encoder onto the drive shaft and insert the stud screw (customer-mounted) into the encoder's rubber buffer.
- Spring washer
Fasten the spring washer at the mounting holes of the encoder housing using screws. Push the encoder onto the drive shaft and mount the spring washer to the contact surface.

6.2. Electrical connection

Ever store and transport the bus cover in the ESD bag only.

For electrical connection remove the bus cover as follows:

- Release the fastening screws of the bus cover
- Carefully loosen the bus cover and lift off in an axial direction

6.2.1. Cabling

EtherNet/IP utilizes Fast Ethernet cable (100MBit, Cat 5) composed of four wires AWG22 (white, yellow, blue and orange).

There are three types of EtherNet/IP cables:

- Type A – for fix or rigid cabling
- Type B – for occasional movements or vibrations (flexible)
- Type C – for permanent movements (highly flexible).

6.2.2. Connecting the bus cover

The bus cover provides three M12 connectors.

Two M12 connectors (D-coded, according IEC 61076-2-101) serve for EtherNet/IP implementation.

Shaft / blind hollow shaft encoder

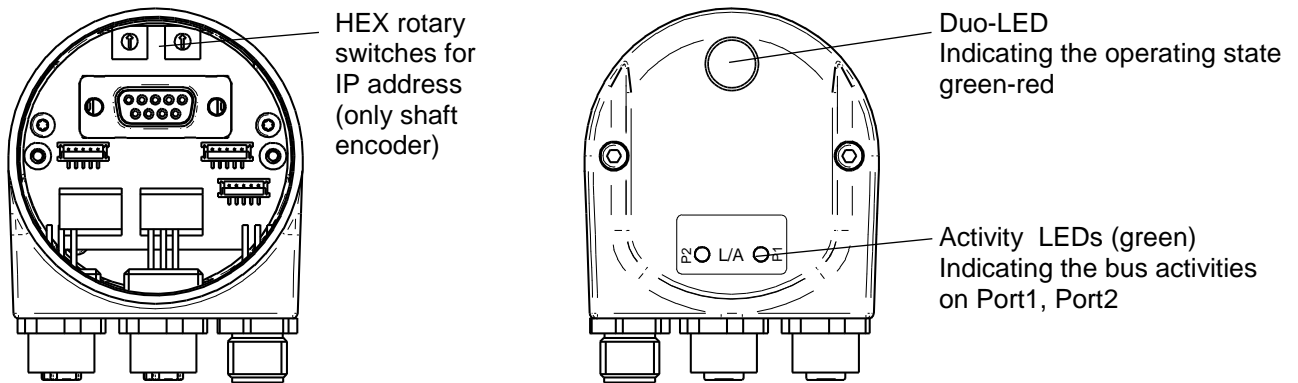

Fig. 4a: Bus cover shaft / blind hollow shaft – electrical assignment and LED

Through hollow shaft encoder

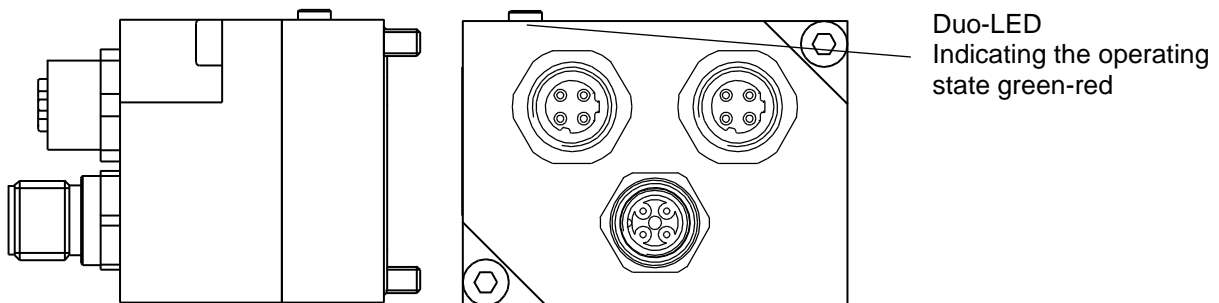
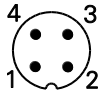

Fig. 4b: Bus cover hollow shaft– electrical assignment and LED

- For voltage supply use A-coded M12 connector only.
- For the bus lines both D-coded M12 connectors may be used at will.
- Seal up the unused cable gland using a sealing bolt (included in the delivery).

The IP address can be set via two HEX rotary switches (only shaft encoder) inside the bus cover (see section 7). There is no need to carry out further manual settings inside the bus cover.

Pin assignment
Supply voltage

1 x M12 (connector)
A-coded

Pin	Assignment
1	UB (10...30 VDC)
2	N.C.
3	GND
4	N.C.

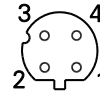
EtherNet/IP (data line)

2 x mating M12 (female)
D-coded

Pin	Assignment
1	TxD+
2	RxD+
3	TxD-
4	RxD-

Assembly of basic encoder and bus cover

- Carefully plug the bus cover onto the D-SUB connector of the basic encoder, then press it over the seal and take care not to tilt.
- Tighten both fastening screws firmly in the same direction.
- The bus cover must fully rest on the housing of the basic encoder and be firmly screwed on.

The encoder housing and braided shield of the connecting cable are only ideally connected if the bus cover is resting fully on the basic encoder (form-locking)..



If bus cover was removed from basic encoder, make sure supply is stable for at least 2 seconds at next power-on. Otherwise MAC ID and serial number may be deleted.

6.3. Operating display (multi-colour LED)

A DUO LED (green and red) is located in the bus cover. This reflects the machine status of the position sensor object in accordance with Ethernet/IP specifications and provides information on the encoder status.

LED status	Status	Description
Off	Not connected	No power supply
Green flashing	Device is active and online, no connection exists	The device is operating under normal conditions and is online. No connection has been established to a scanner. - Encoder has not yet been configured by the scanner - Configuration not complete or faulty
Green	Device is active and online Connections have been established	The device is operating under normal conditions and is online, connections are in the Established status
Red	Critical device fault or critical communication error	The device is in an irreparable error status
Red flashing	Recoverable fault	I/O connections are in the time-out status
2 Hz green/red	Self test	Immediately on connection of supply voltage, the device carries out a self-test.

Table 22: LED operating display statuses

6.4. Activity display (green LEDs)

In the bus cover, another two green LEDs are integrated. These indicate data traffic at the two ports P1 and P2. In case of occasional data traffic (e.g. during ramp-up), the LEDs flash intermittently, but in the event of fast cyclical data exchange can appear as if permanently on.

Immediately after connection of the supply voltage, both LEDs carry out a self test with a frequency of 2 Hz.

7. IP address allocation

For operation of the EtherNet/ IP encoder, the device must be allocated an IP address. This can be issued statically once only, or can be allocated again dynamically every time the device is switched on.

Devices featuring two HEX rotary switches will be allocated their IP address by the following procedure:

7.1. EtherNet/IP bus cover with HEX rotary switches: IP-assignment after Power On

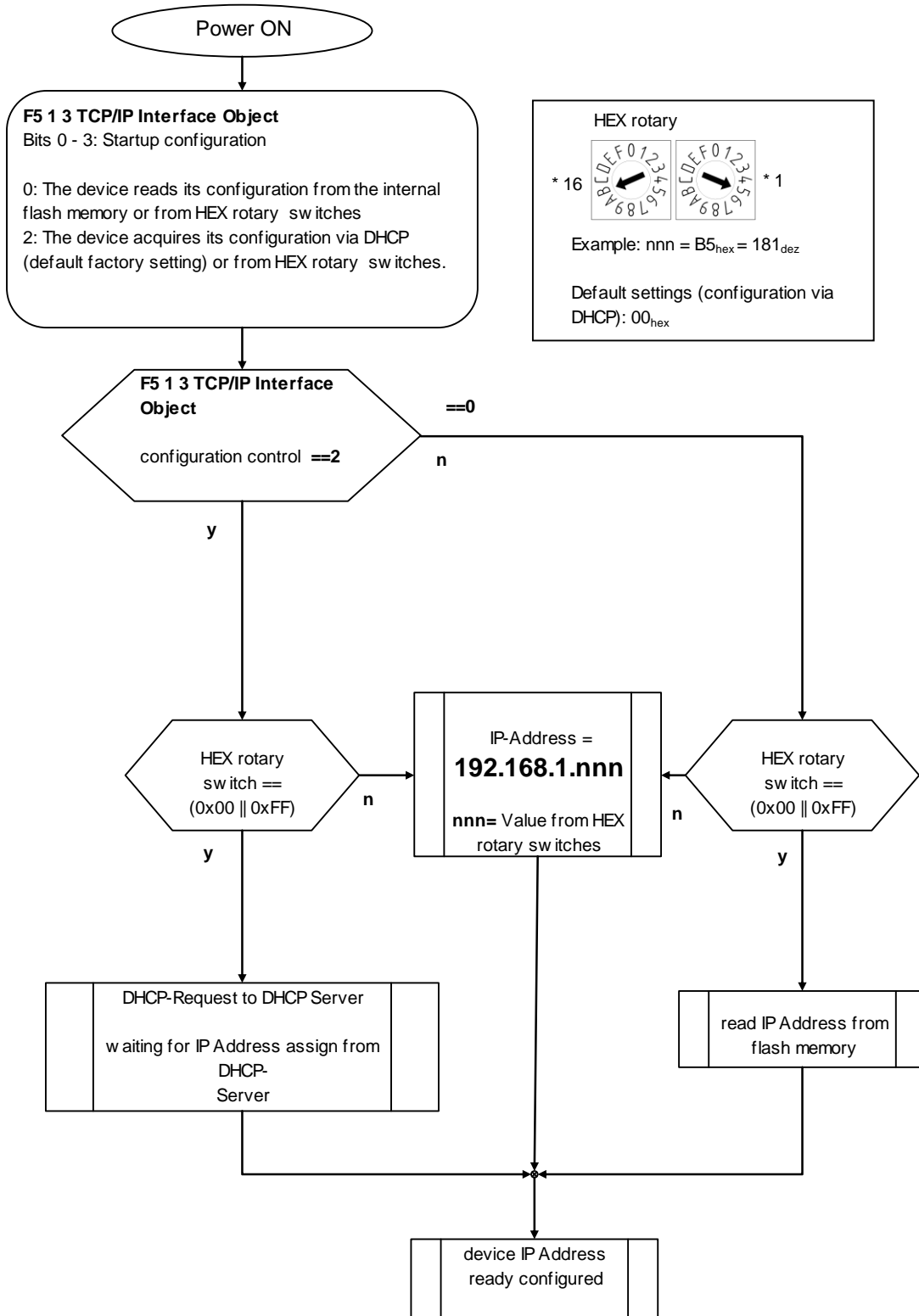

7.2. Allocate IP address with BOOTP/DHCP configuration tool

Factory Device default is mode „IP Address over DHCP-Request“

The IP address must be allocated by a DHCP server.

This DHCP server (software) can be obtained as freely available software from the Allen-Bradley Rockwell website.

www.ab.com/networks/ethernet/bootp.html

The DHCP server must be in the same network as the encoder.

Carry out the relevant settings under *Tools, Network Settings*

After installation, a connected Ethernet/IP encoder registers as follows:

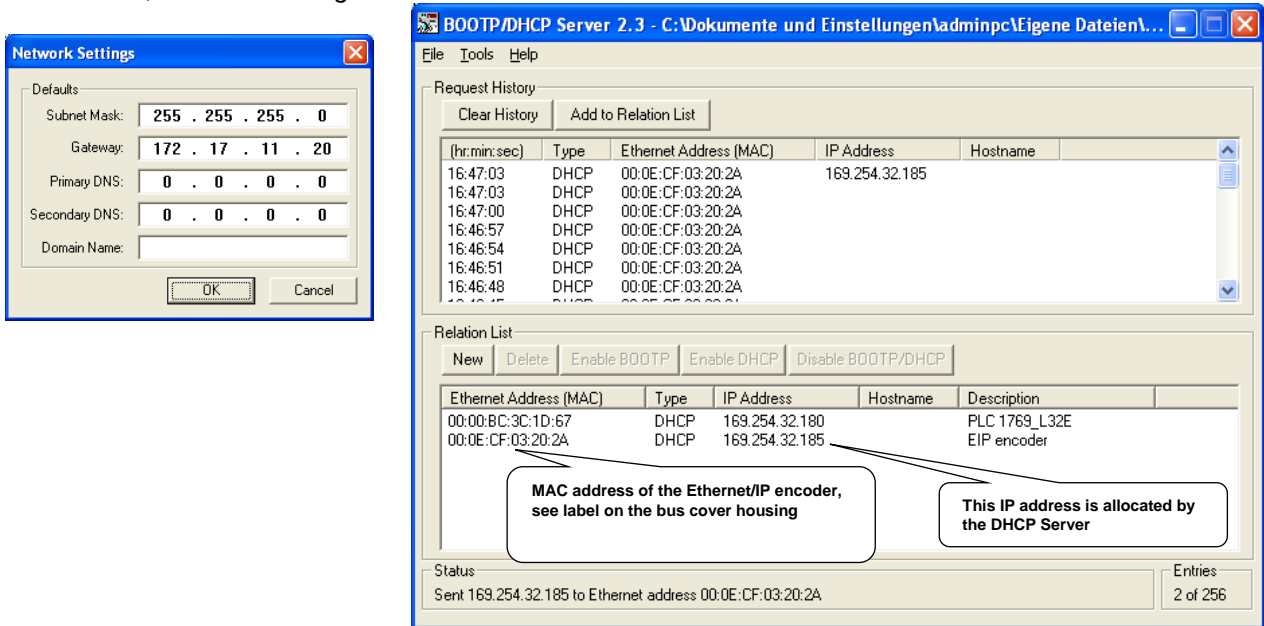
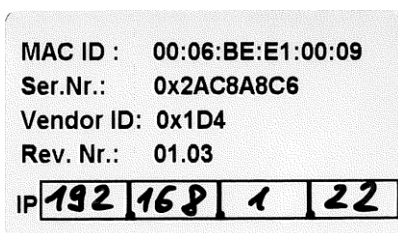

Fig. 5:DHCP server tool

Using the **Disable BOOT/DHCP** button (answer on successful execution: Command successful) this IP address can be statically allocated, i.e. the next time the encoder is switched on and off, no further request is sent to the DHCP Server. The encoder operates from now on with the previously assigned IP address. „**IP address out of internal flash**“.

Note:

Please carefully put down any updated IP address in the field provided on the product label (to prevent any future problems in operation in other networks, refer also to annex FAQs.)



Example: Product label with hand-written IP address

Instance attributes 3 of TCP/IP object, class code: F5_{Hex} holds IP Addressing Mode

Class ID	Attribute ID	Access	Name	Data type	Description
0xF5	3	read/write	Configuration Attribute	DWORD	Determines how the device receives its initial configuration after switching on

Table 23: Attribute 3 TCP/IP object

Values

- 0** = Interface configuration out of non-volatile memory **or** by Hardware (HEX rotary switch)
- 2** = Interface configuration via DHCP server (factory setting)

7.3. RSLinx Classic Lite

RSLinx Classic Lite for Rockwell Automation networks and devices is an operating communication solution for a large number of Rockwell Software and Allen-Bradley applications.

RSLinx Classic Lite has the minimum functionality required to support RSLogix and RSNetWorx.

This version is not commercially available, but is included in the scope of supply of products which only require direct access to RSLinx classic network drivers.

RSLinx classic lite can be used for the following processes:

- Programming of contact plan logic with the aid of RSLogix products.
- Network and device configuration and diagnosis with the aid of RSNetWorx.
- Configuration of Ethernet modules / devices (e.g. 1756-ENET, 1756-DHRIO etc.).
- Browsing networks and scanning device information (e.g. firmware version number).

7.4. RSWho

RSWho is the main window of RSLinx Classic Lite and is similar to the graphic display of networks and devices in the Windows Explorer.

The left-hand window area of RSWho is the directory control area which displays networks and devices.

In this example, the encoder previously configured with the DHCP server in the network is shown alongside the IP address.

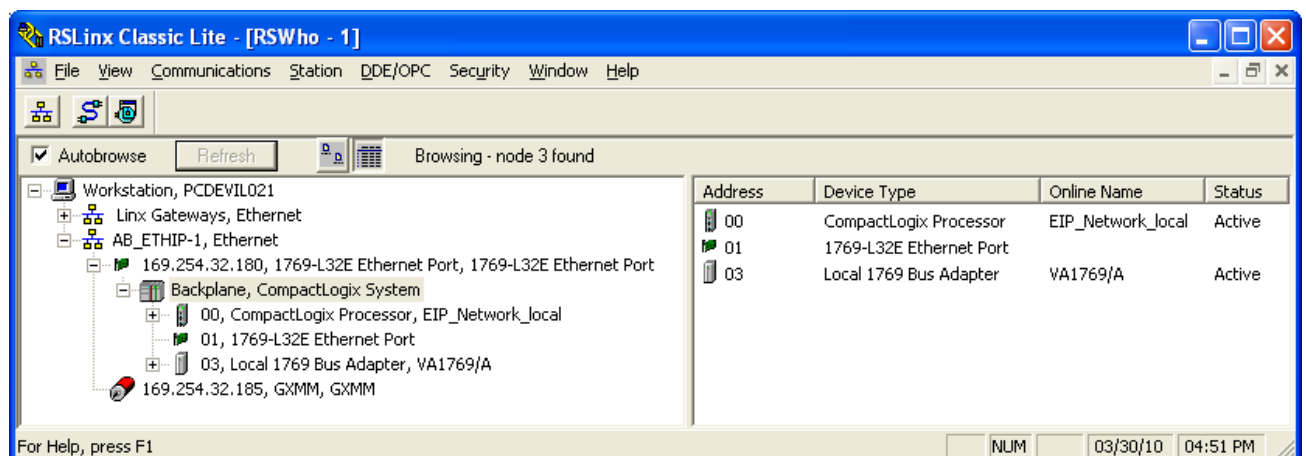

Fig. 6: View under RSLinx Classic Lite

8. Device configuration

8.1. Introduction

On principle, the encoder with the parameters preset in the factory is ready for operation. Despite this, after setting the IP address as described in section 7, it will be necessary to adjust the encoder configuration for the relevant application.

The encoder properties which will require adjusting include:

- ***Sense of rotation / definition of the counting direction***
- ***Measurement range within a rotation***
- ***Total measurement range of the encoder***
- ***Matching the encoder coordinate system with the coordinate system of the application (preset value)***

All the specified characteristics are saved immediately following an error-free transmission as non-volatile values in the device. However, the save process is only initiated if a value is changed. A repeat transmission of identical values does not initiate a save routine.

There are 3 independent mechanisms with identical rights available which can be used but which do not each individually have to be used. It makes sense and may be necessary to combine several different mechanisms (please observe the following note regarding setting the preset value).

The next 3 sections describe examples of the encoder configuration for each of these mechanisms.

Note

Matching the coordinate systems using the preset value is not possible in the case of the configuration assembly instance, as transmission of the configuration assembly instance takes place with the Forward Open Frames function while establishing communication.

Setting the position value is not customarily linked to the time at which a cyclical connection is established.

The preset value can be set for instance by using the parameter object, while all other settings are carried out using the configuration assembly instance.

8.2. Using the parameter object

When using the parameter object (class code 0Fhex), configuration takes place over the set attribute single service of the instance attribute (parameter value).

In order to check the required setting value, the admissible setting range of the parameter can be previously determined by reading the minimum value (instance attribute 10) and the maximum value (instance attribute 11).

As the setting limits of the encoder's total measurement range are calculated at a certain time from the currently set measurement range within a revolution, the measurement range should be set within a revolution before the encoder's total measurement range. Fig. 7 illustrates the schematic sequence of encoder configuration using the parameter object.

If invalid setting values are written (e.g. setting value outside the setting range of the parameter), the encoder rejects the value with an error message (see Fig. 8, status = 0x03hex).

If the set attribute single service is performed without errors, the status 0x00 hex is returned.

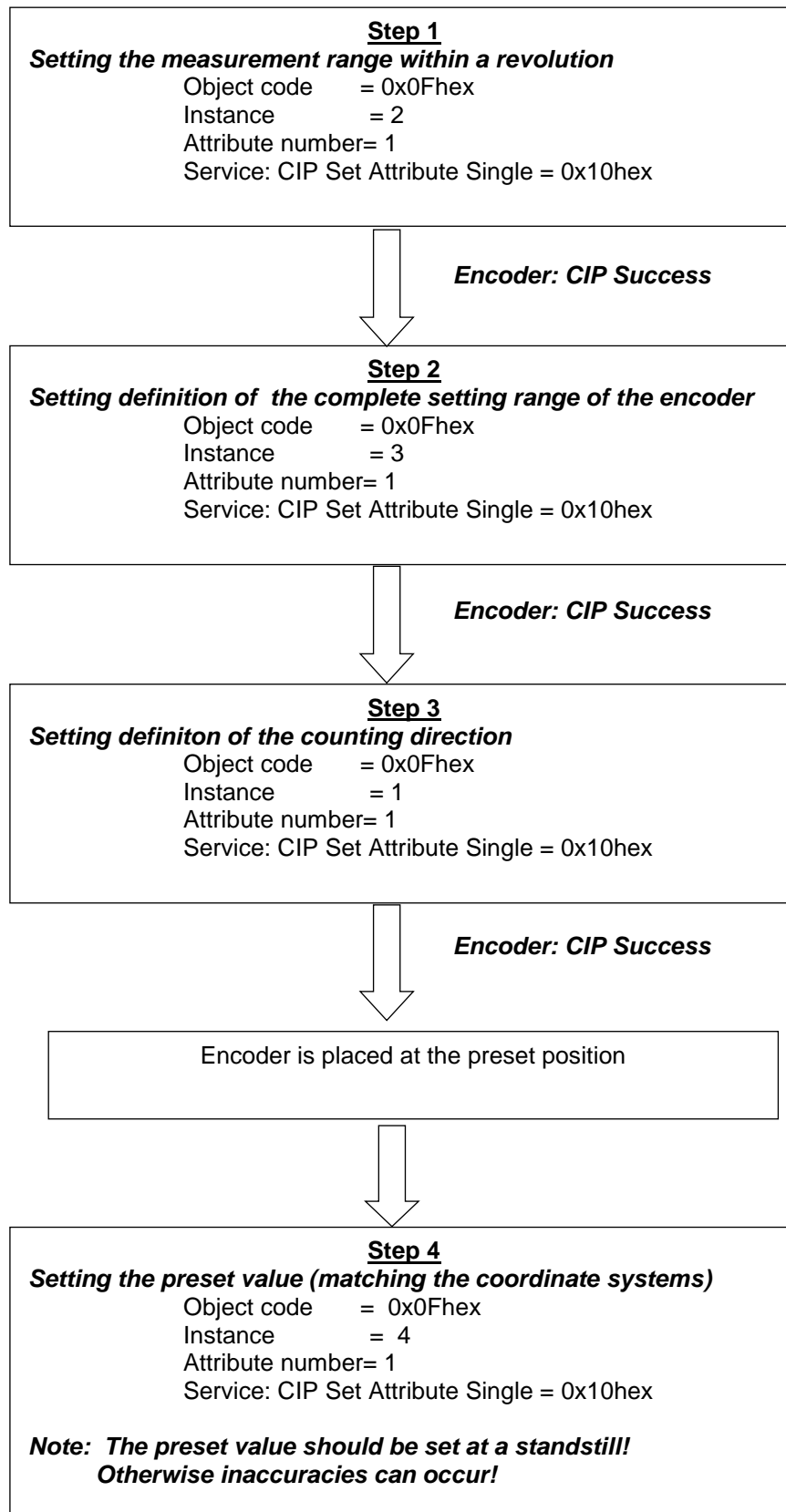

Fig. 7: Encoder configuration with the parameter object

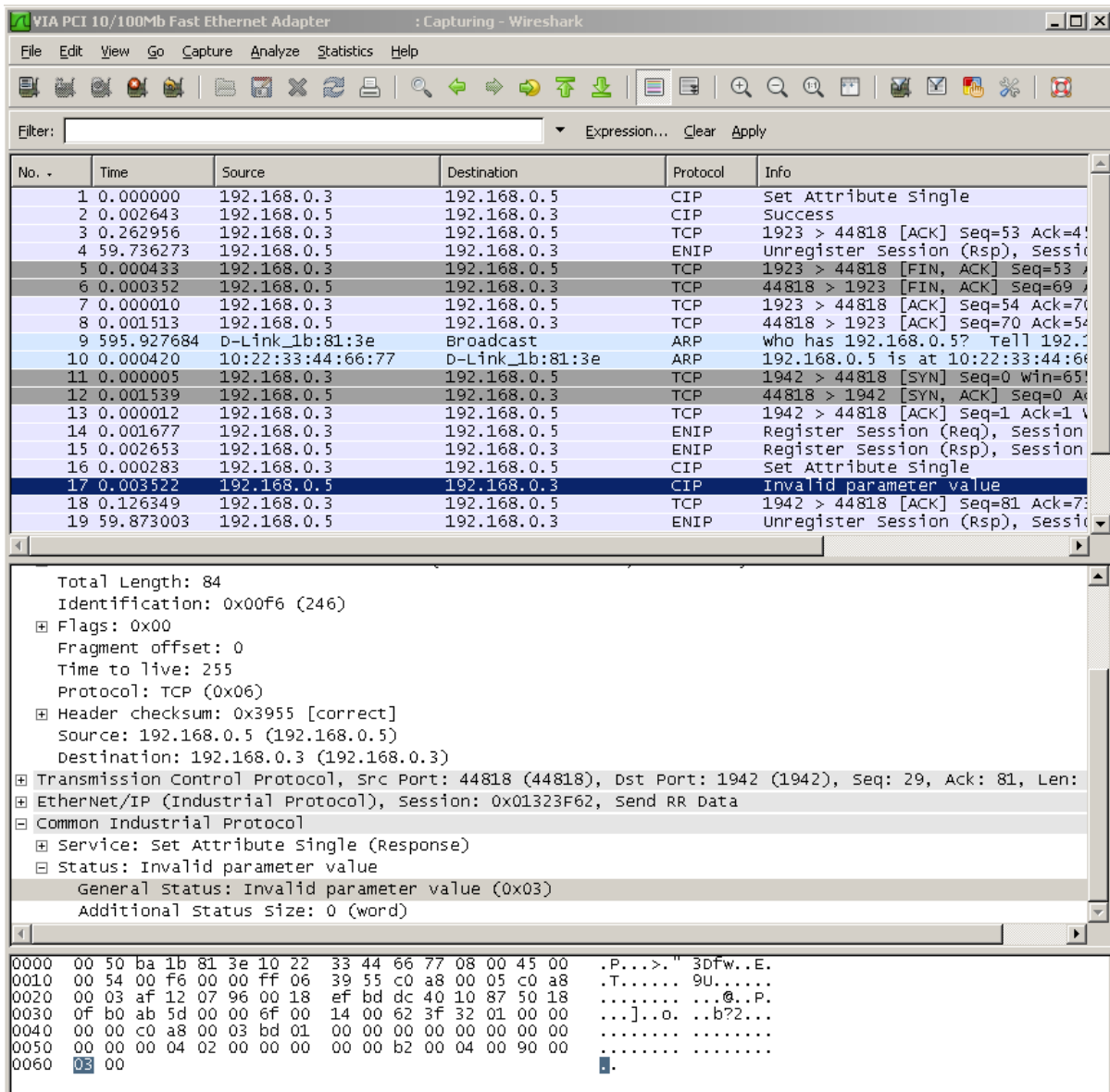

Fig. 8: Record of a faulty set attribute single service

From the viewpoint of the encoder, configuration of the setting values (steps 1-4 in Fig. 7) can only be carried out only once.

From the point of view of the application, it can also make sense to execute steps 1-3 for instance after switching on the encoder.

The parameter object also offers the possibility of reading out text strings for the parameter names, the parameter unit and a help text from the encoder in compliance with the “Common Industrial Protocol Specification”. The language used is English.

8.3. Application of the configuration assembly instance 105

When using configuration assembly instance 105, configuration of the encoder takes place with transmission in the Forward Open Frame while establishing the connection (see Fig. 9).

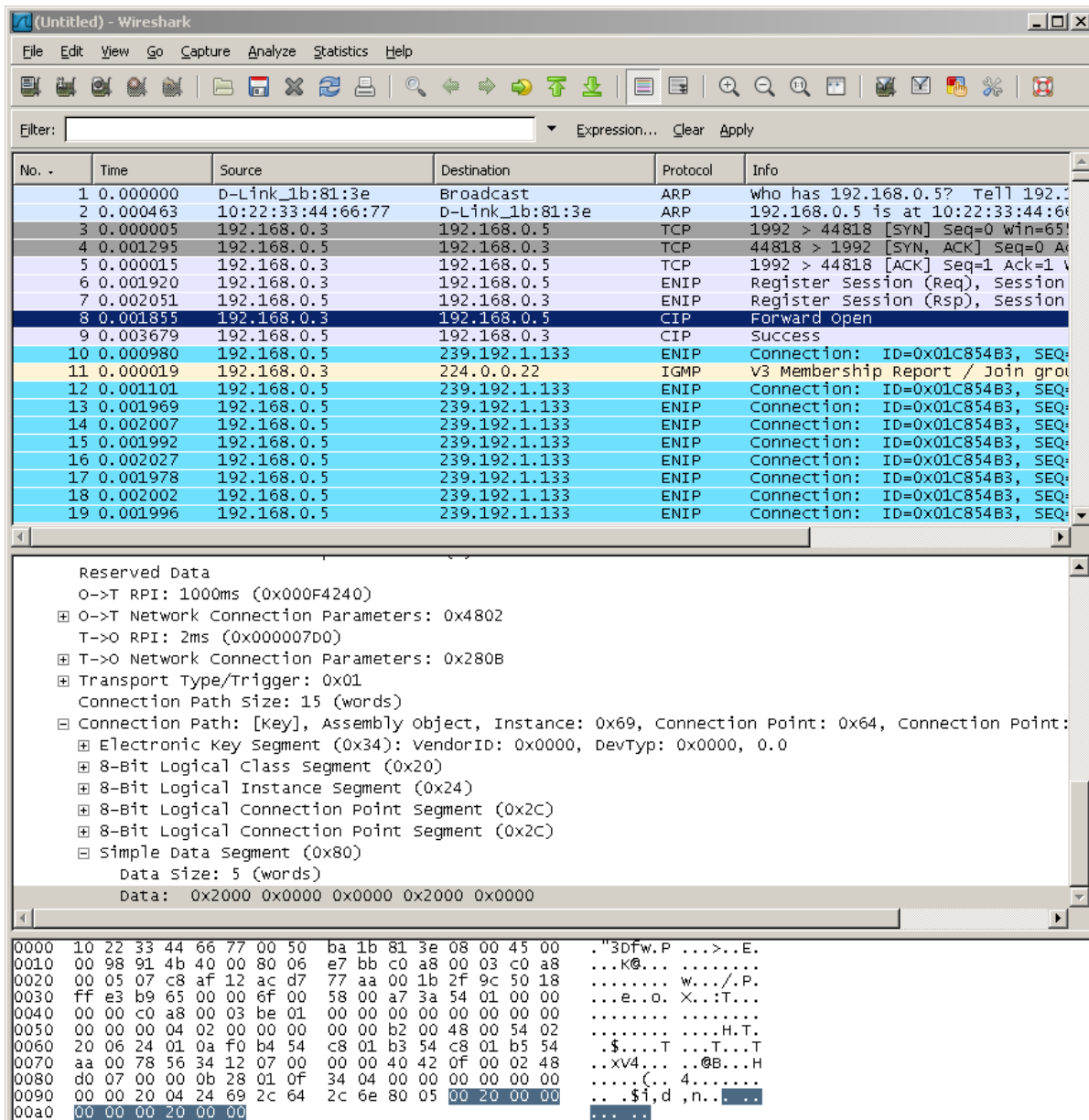

No.	Time	Source	Destination	Protocol	Info
1	0.000000	D-Link_1b:81:3e	Broadcast	ARP	who has 192.168.0.5? Tell 192.168.0.5
2	0.000463	10:22:33:44:66:77	D-Link_1b:81:3e	ARP	192.168.0.5 is at 10:22:33:44:66:77
3	0.000005	192.168.0.3	192.168.0.5	TCP	1992 > 44818 [SYN] Seq=0 Win=65535 Len=0
4	0.001295	192.168.0.5	192.168.0.3	TCP	44818 > 1992 [SYN, ACK] Seq=0 Ack=1992 Len=0
5	0.000015	192.168.0.3	192.168.0.5	TCP	1992 > 44818 [ACK] Seq=1 Ack=1992 Len=0
6	0.001920	192.168.0.3	192.168.0.5	ENIP	Register session (Req), Session ID=0x01C854B3, SEQ=0
7	0.002051	192.168.0.5	192.168.0.3	ENIP	Register session (Rsp), Session ID=0x01C854B3, SEQ=0
8	0.001855	192.168.0.3	192.168.0.5	CIP	Forward open
9	0.003679	192.168.0.5	192.168.0.3	CIP	Success
10	0.000980	192.168.0.5	239.192.1.133	ENIP	Connection: ID=0x01C854B3, SEQ=0
11	0.000019	192.168.0.3	224.0.0.22	IGMP	v3 Membership Report / Join group
12	0.001101	192.168.0.5	239.192.1.133	ENIP	Connection: ID=0x01C854B3, SEQ=0
13	0.001969	192.168.0.5	239.192.1.133	ENIP	Connection: ID=0x01C854B3, SEQ=0
14	0.002007	192.168.0.5	239.192.1.133	ENIP	Connection: ID=0x01C854B3, SEQ=0
15	0.001992	192.168.0.5	239.192.1.133	ENIP	Connection: ID=0x01C854B3, SEQ=0
16	0.002027	192.168.0.5	239.192.1.133	ENIP	Connection: ID=0x01C854B3, SEQ=0
17	0.001978	192.168.0.5	239.192.1.133	ENIP	Connection: ID=0x01C854B3, SEQ=0
18	0.002002	192.168.0.5	239.192.1.133	ENIP	Connection: ID=0x01C854B3, SEQ=0
19	0.001996	192.168.0.5	239.192.1.133	ENIP	Connection: ID=0x01C854B3, SEQ=0

```

Reserved Data
O->T RPI: 1000ms (0x000F4240)
O->T Network Connection Parameters: 0x4802
T->O RPI: 2ms (0x000007D0)
T->O Network Connection Parameters: 0x280B
Transport Type/Trigger: 0x01
Connection Path Size: 15 (words)
Connection Path: [key], Assembly Object, Instance: 0x69, Connection Point: 0x64, Connection Point:
Electronic Key Segment (0x34): vendorID: 0x0000, DevTyp: 0x0000, 0.0
8-Bit Logical Class Segment (0x20)
8-Bit Logical Instance Segment (0x24)
8-Bit Logical Connection Point Segment (0x2C)
8-Bit Logical Connection Point segment (0x2C)
Simple Data Segment (0x80)
Data size: 5 (words)
Data: 0x2000 0x0000 0x0000 0x2000 0x0000
    
```

Offset	Time	Source	Destination	Protocol	Info												
0000	10	22	33	44	66	77	00	50	ba	1b	81	3e	08	00	45	00	..3dfw.P ...>..E.
0010	00	98	91	4b	40	00	06	06	e7	bb	c0	a8	00	03	c0	a8	...K@...
0020	00	05	07	c8	af	12	ac	d7	77	aa	00	1b	2f	9c	50	18w.../..P.
0030	ff	e3	b9	65	00	00	6f	00	58	00	a7	3a	54	01	00	00	...e..o. X.:T...
0040	00	00	c0	a8	00	03	be	01	00	00	00	00	00	00	00	00
0050	00	00	00	04	02	00	00	00	00	00	b2	00	48	00	54	02H.T.
0060	20	06	24	01	0a	f0	b4	54	c8	01	b3	54	c8	01	b5	54	..\$....T ...T...T
0070	aa	00	78	56	34	12	07	00	00	00	40	42	0f	00	02	48	..xv4... ..@B...H
0080	d0	07	00	00	0b	28	01	0f	34	04	00	00	00	00	00	00(. 4... ..
0090	00	00	20	04	24	69	2c	64	2c	6e	80	05	00	20	00	00	...\$. ,d ,n... ..
00a0	00	00	00	20	00	00	00	00	00	00	00	00	00	00	00	00

Fig. 9: Configuration assembly instance 105 in the Forward Open Frame

As only one exclusive owner connection is accepted at any time by the bus cover (see also section 4.6), this connection type can be used, for example, in order to transmit the configuration assembly instance.

The data structure of the assembly instance 105 is shown in table 13 on page 22. The data is taken individually from the bus cover in the following sequence:

1. **Setting the measurement range within a revolution (measuring units per span)**
2. **Setting the total measurement range of the encoder (total measuring range in measuring units)**
3. **Setting the definition of the counting direction (direction counting toggle)**

Transfer of the configuration data takes place internally in the device via the parameter object. This ensures that the transfer of configuration values takes place after the same checks as with direct utilization of the parameter object (see section 8.2).

If an error is detected in the data of the configuration assembly instance, no connection is established. The connection is rejected on the part of the encoder with a connection failure frame (see Fig. 10, status = 0x01, additional status = 0x0118).

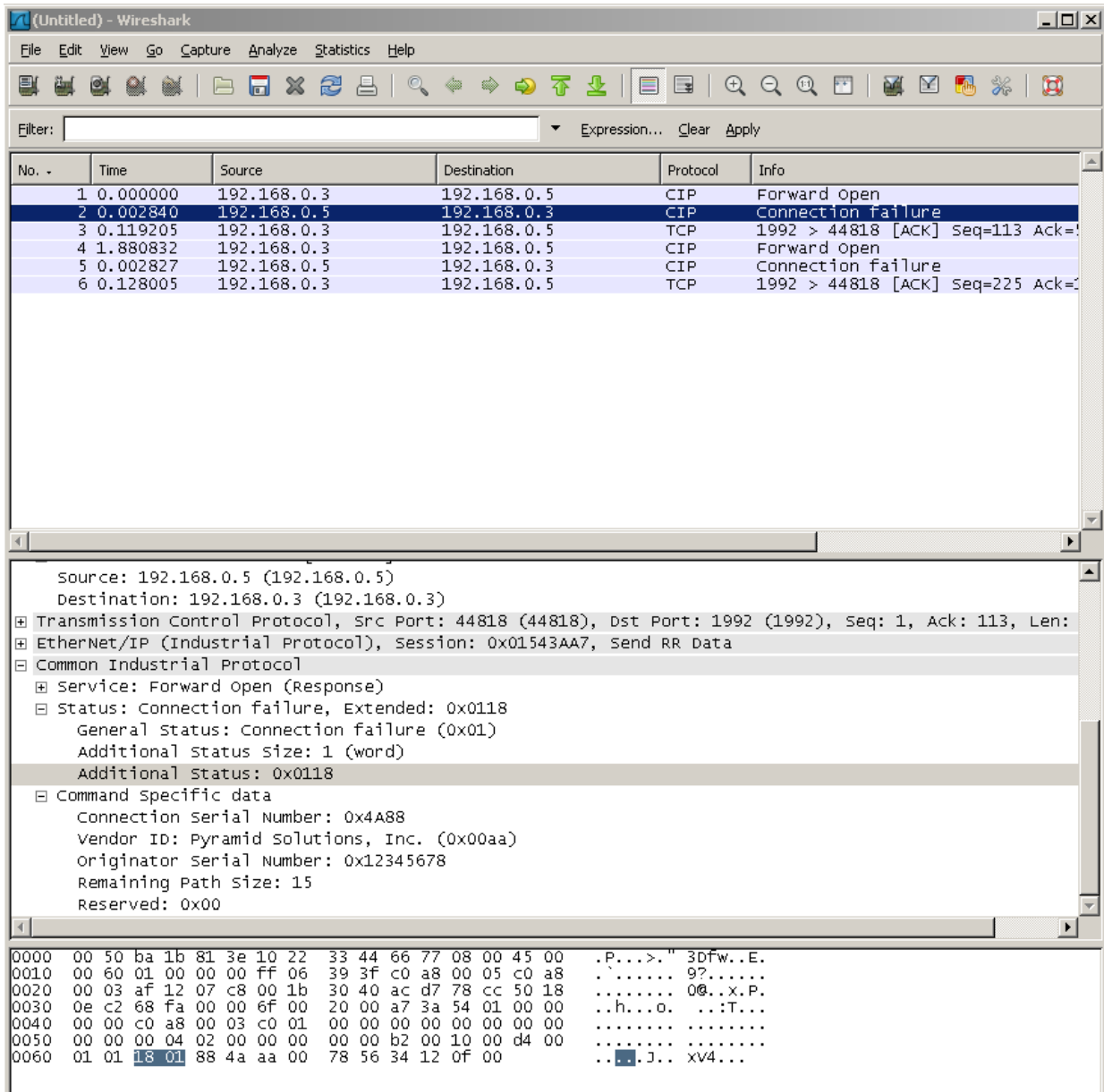

No. -	Time	Source	Destination	Protocol	Info
1	0.000000	192.168.0.3	192.168.0.5	CIP	Forward Open
2	0.002840	192.168.0.5	192.168.0.3	CIP	Connection failure
3	0.119205	192.168.0.3	192.168.0.5	TCP	1992 > 44818 [ACK] Seq=113 Ack=
4	1.880832	192.168.0.3	192.168.0.5	CIP	Forward Open
5	0.002827	192.168.0.5	192.168.0.3	CIP	Connection failure
6	0.128005	192.168.0.3	192.168.0.5	TCP	1992 > 44818 [ACK] Seq=225 Ack=

Source: 192.168.0.5 (192.168.0.5)
 Destination: 192.168.0.3 (192.168.0.3)

- Transmission Control Protocol, Src Port: 44818 (44818), Dst Port: 1992 (1992), Seq: 1, Ack: 113, Len:
- EtherNet/IP (Industrial Protocol), Session: 0x01543AA7, Send RR Data
- Common Industrial Protocol
 - Service: Forward Open (Response)
 - Status: Connection failure, Extended: 0x0118
 - General Status: Connection failure (0x01)
 - Additional Status Size: 1 (word)
 - Additional status: 0x0118
 - Command specific data
 - Connection Serial Number: 0x4A88
 - Vendor ID: Pyramid Solutions, Inc. (0x00aa)
 - Originator Serial Number: 0x12345678
 - Remaining Path Size: 15
 - Reserved: 0x00

```

0000  00 50 ba 1b 81 3e 10 22 33 44 66 77 08 00 45 00  .P...>." 3Dfw..E.
0010  00 60 01 00 00 00 ff 06 39 3f c0 a8 00 05 c0 a8  ..... 9?.....
0020  00 03 af 12 07 c8 00 1b 30 40 ac d7 78 cc 50 18  ..h...o.  :.X.P.
0030  0e c2 68 fa 00 00 6f 00 20 00 a7 3a 54 01 00 00  ..h...o.  :.T...
0040  00 00 c0 a8 00 03 c0 01 00 00 00 00 00 00 00 00  .....
0050  00 00 00 04 02 00 00 00 00 00 b2 00 10 00 d4 00  .....
0060  01 01 18 01 88 4a aa 00 78 56 34 12 0f 00      ...J.. xv4...
    
```

Fig. 10: Connection failure frame due to incorrect value in the assembly instance 105

Note

Even with incorrect data in assembly instance 105, a part of the configuration data may have become effective!

If for instance an incorrect value were written for the counting direction, but the values for setting the measurement range within a revolution and for setting the total measurement range of the sensor were still valid, then these two values would already have been accepted by the encoder before the connection was rejected.

When setting the preset value (matching the coordinate systems), note that the preset value has to be performed again with each change of the measurement range setting within a revolution, or of the encoder's total measurement range (see section 4.4).

For this reason, when using the assembly instance 105 for encoder configuration, ensure that before first setting the preset value (matching the coordinate system) error-free transmission of the assembly instance 105 has taken place at least once.

From the point of view of the encoder, it is also the case for utilization of the configuration assembly instance that the encoder configuration only has to be transmitted once.

From the point of view of the application, transmission must take place at least with each exclusive owner connection.

8.4. Direct application of the position sensor object

The procedure for direct utilization of the position sensor object to configure the encoder only differs marginally from utilization of the parameter object (see section 8.2).

Configuration takes place by means of the set attribute single service of the relevant instance attribute of the position sensor object (23hex).

Direct writing of the position sensor object uses the same control functions for data checking as the parameter object.

If invalid setting values are written (e.g. setting value outside the setting range of the attribute), the sensor rejects the value with an error message. (See also Fig. 8, status = 0x03hex).

In the event of error-free execution of the set attribute single service, the status 0x00 hex is returned.

From the point of view of the encoder, the configuration of setting values (steps 1 – 4 in Fig. 11) only needs to be performed once.

However, from the point of view of the application, it may make sense for example to carry out steps 1- 3 every time the encoder is switched on.

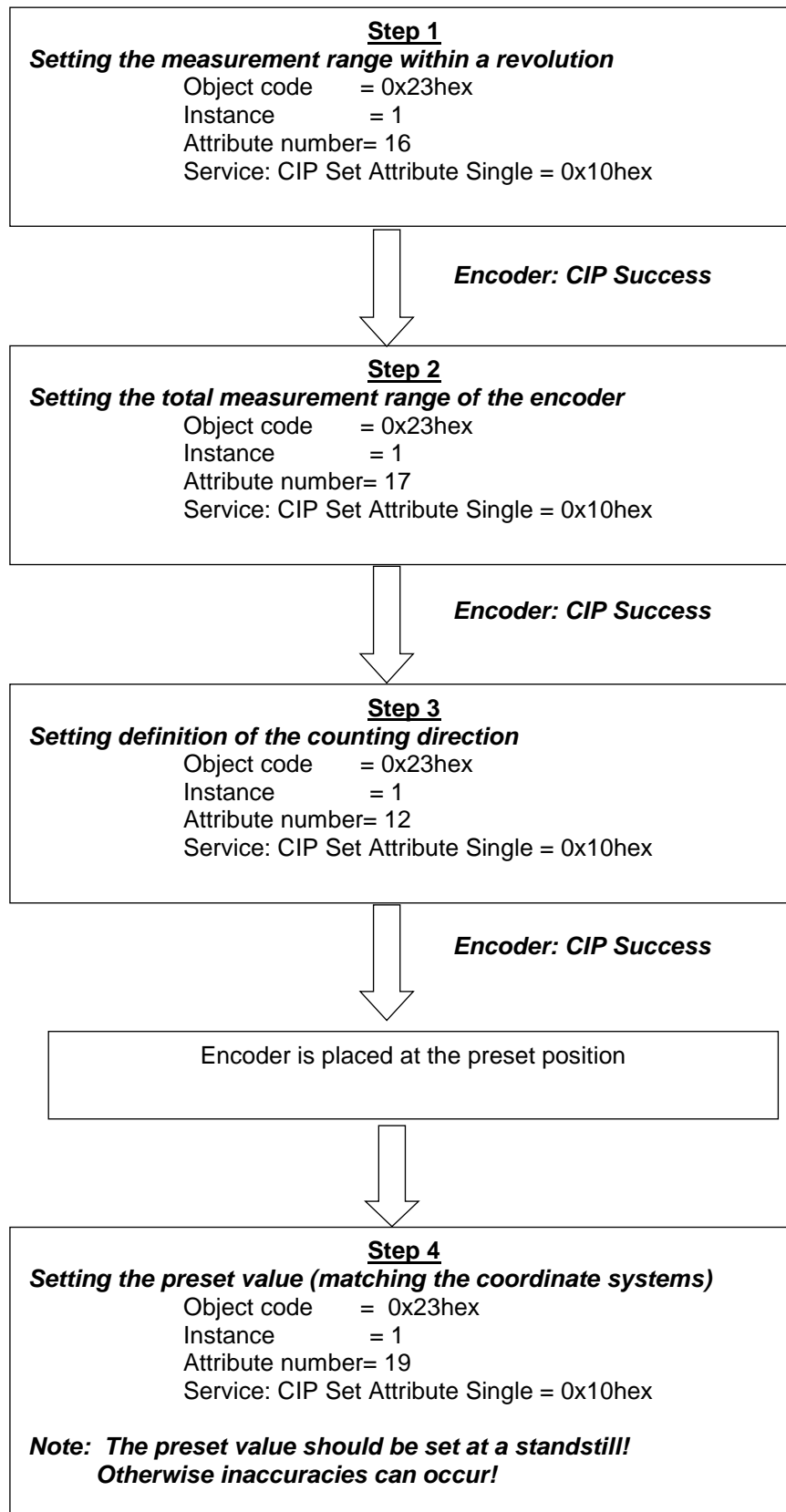

Fig. 11: Encoder configuration with the position sensor object

9. RSLogix5000 project example

9.1. Reading in the input data

- Create a new project under RSLogix5000
- Select New Module
- Select ETHERNET MODULE Generic Ethernet

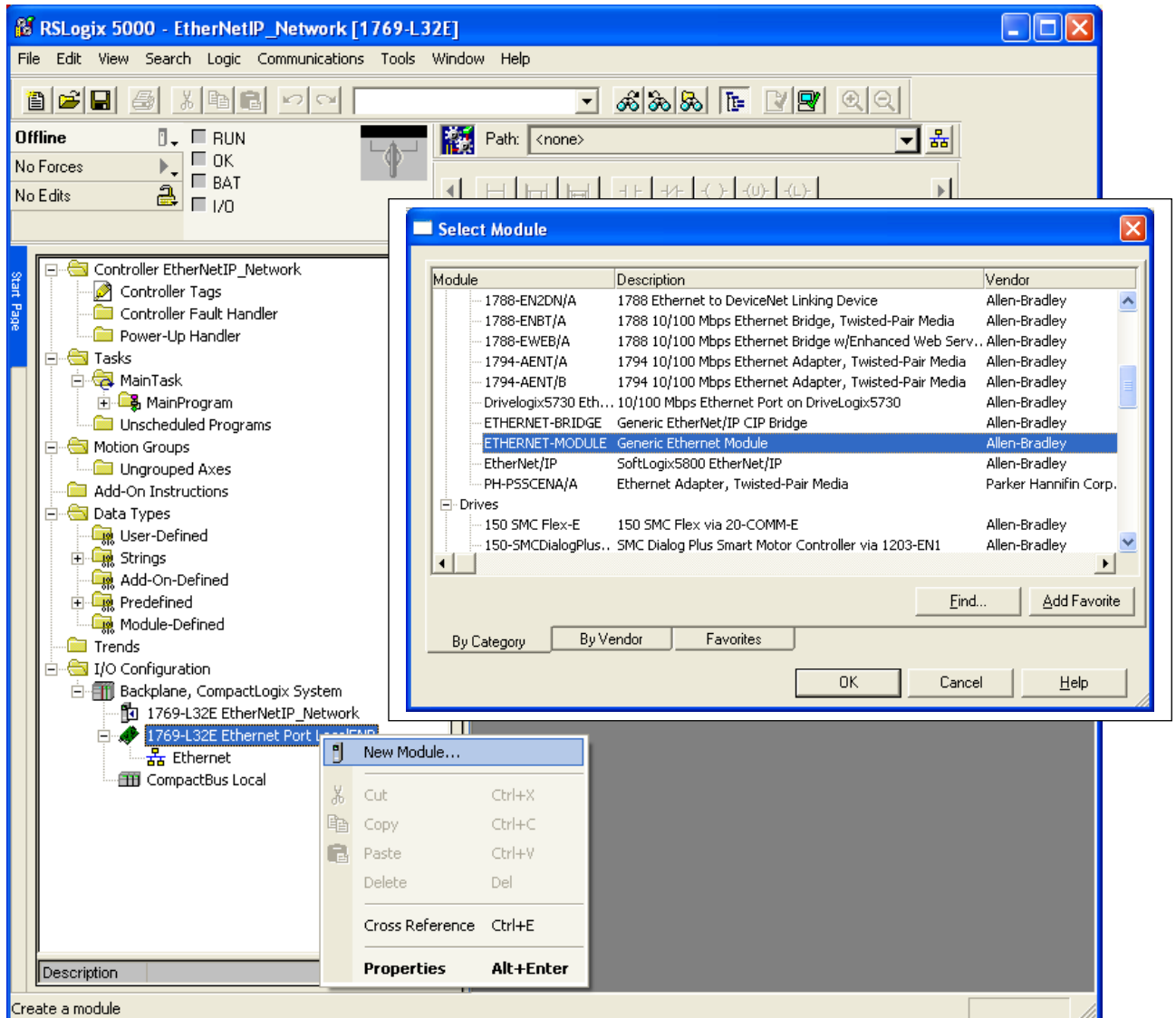

Fig. 12: Generic Ethernet Module

9.1.1. Configure Generic Ethernet Module

Select assembly instance (see chapter I/O assembly instances)

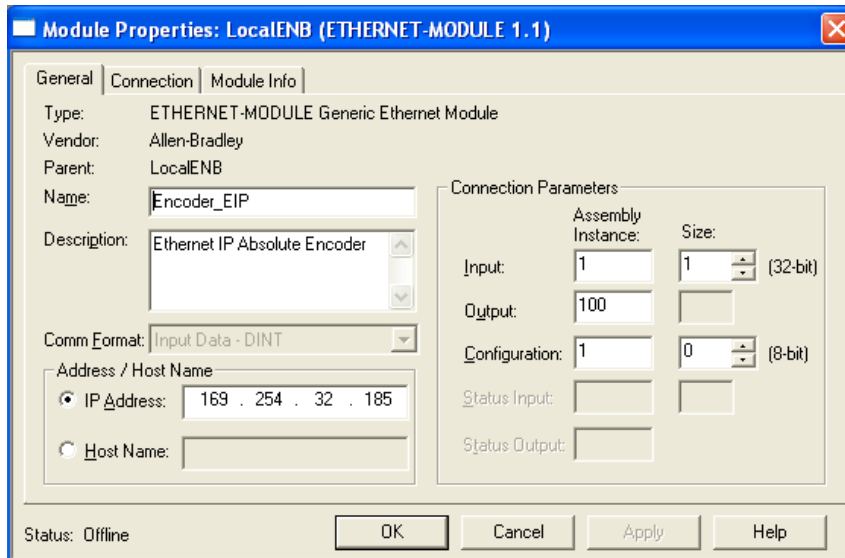

Fig. 13: Configuration assembly instances

Select requested packet interval

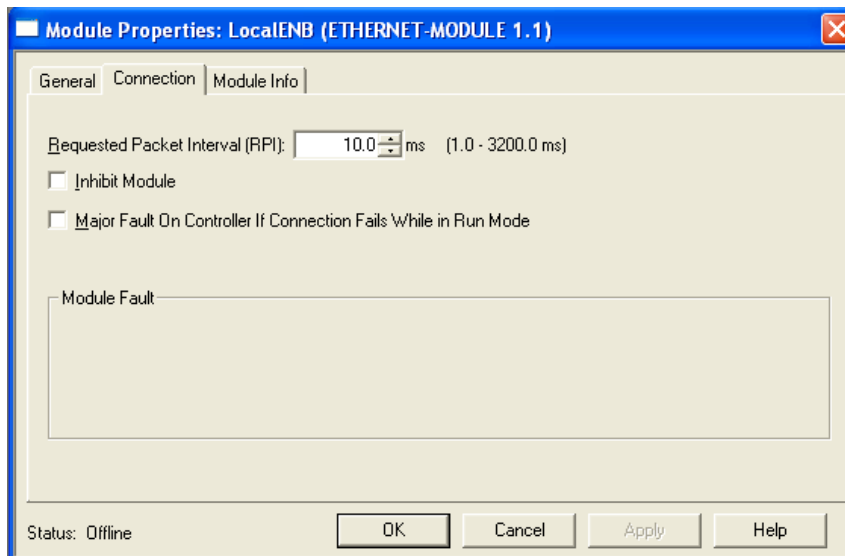



Fig. 14: Define cycle time inputs

Min. cycle time: 2 ms

Max. cycle time: 3200 ms

Select the network path by clicking on the symbol 

Go Online

With Download, start transmission to the PLC and start the PLC program with RUN.

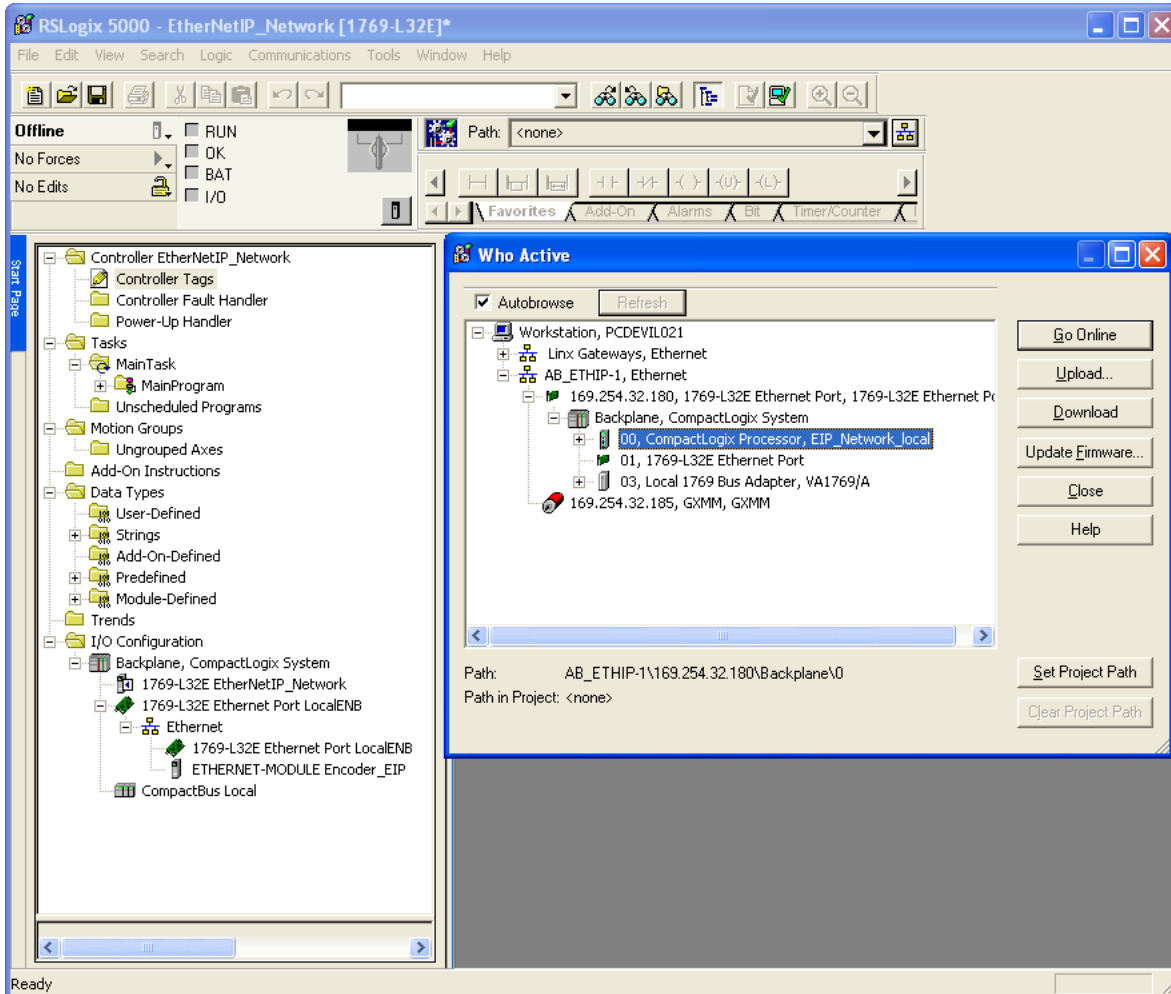

Fig. 15: Select network path

Observe encoder position (input data) with monitor tags

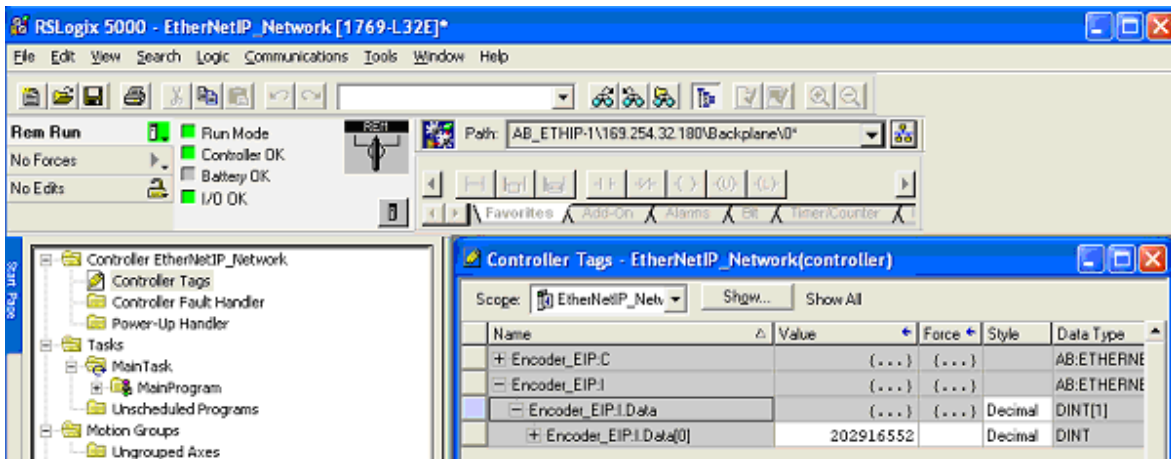

Fig. 16: Monitor tags position data

9.2. Explicit Messaging, PLC Program Example, Set Preset

Here: Set attribute single to class 0x23, instance 1, attribute 0x13

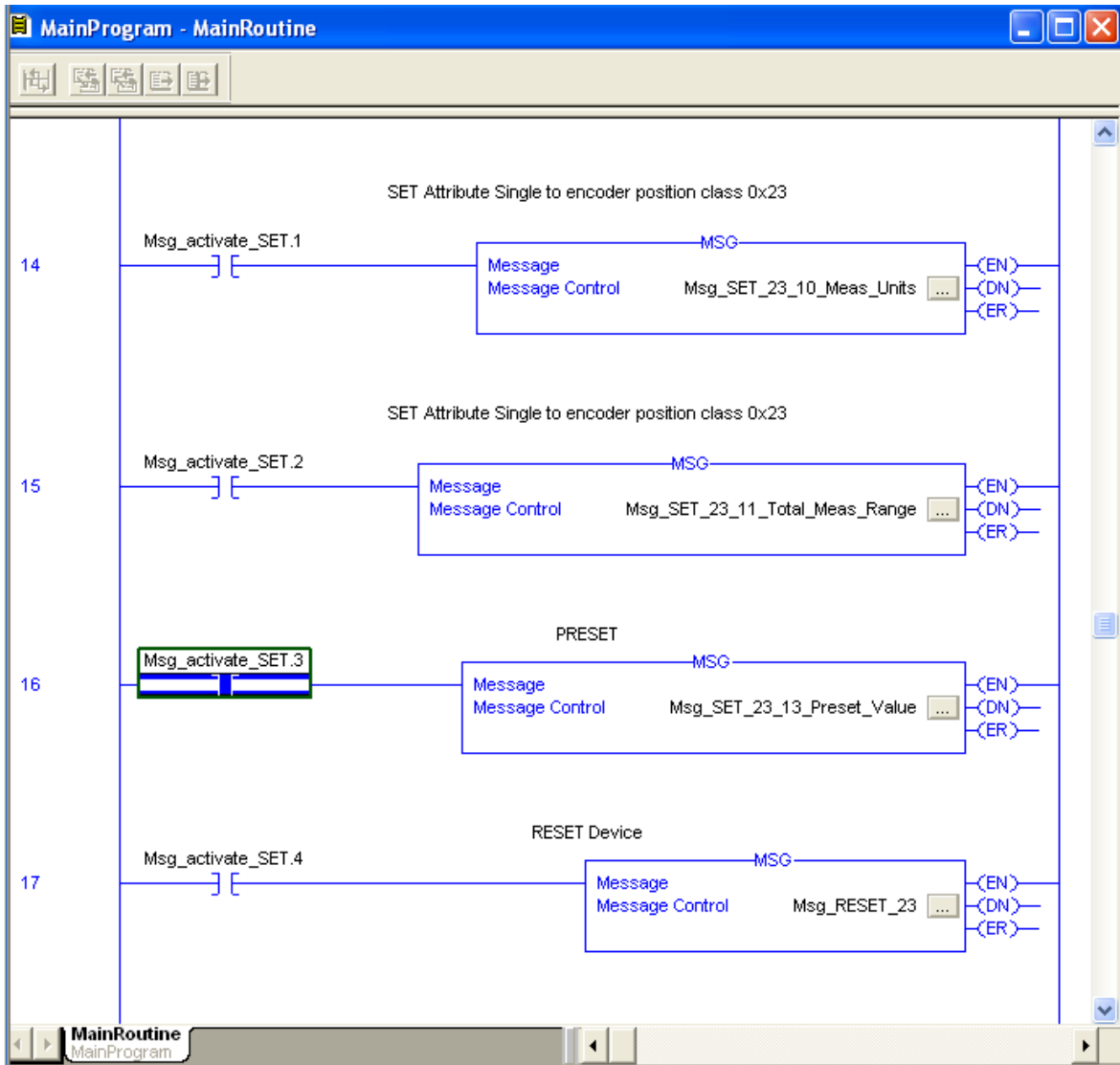

Fig. 17: Ladder logic depiction

9.2.1. Create program tags

Create Msg_activate_SET for activation of the preset command

The screenshot shows the 'Program Tags - MainProgram' window with the following table:

Name	Alias For	Base Tag	Data Type
Msg_activate_GET			DINT
Msg_activate_SET			DINT

Fig. 18: Structure of Msg_activate_SET

9.2.2. Create Controller Tags

1. MESSAGE-type tag for the preset set command
2. DINT-type tag for input of the required values

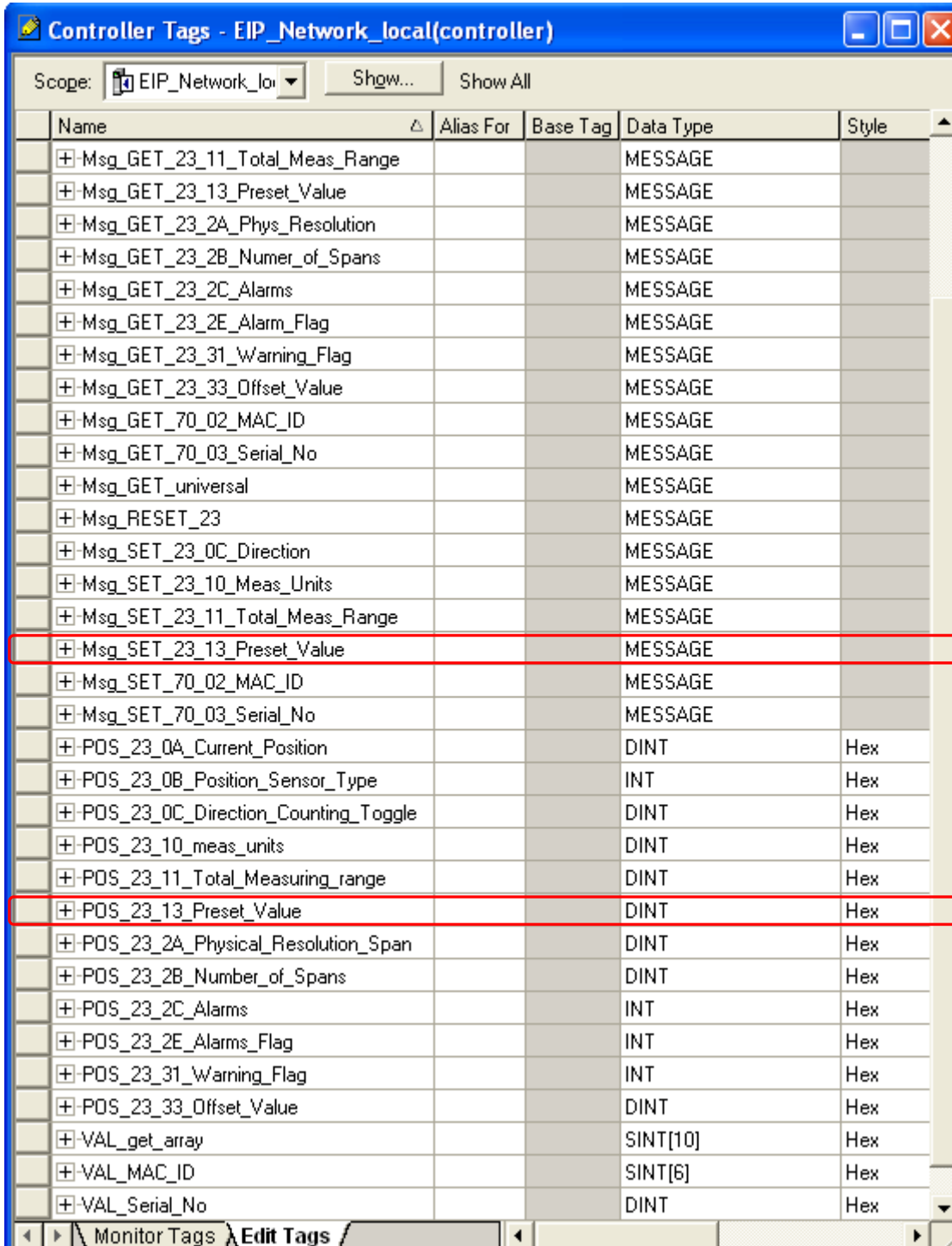

Name	Alias For	Base Tag	Data Type	Style
+Msg_GET_23_11_Total_Meas_Range			MESSAGE	
+Msg_GET_23_13_Preset_Value			MESSAGE	
+Msg_GET_23_2A_Phys_Resolution			MESSAGE	
+Msg_GET_23_2B_Numer_of_Spans			MESSAGE	
+Msg_GET_23_2C_Alarms			MESSAGE	
+Msg_GET_23_2E_Alarm_Flag			MESSAGE	
+Msg_GET_23_31_Warning_Flag			MESSAGE	
+Msg_GET_23_33_Offset_Value			MESSAGE	
+Msg_GET_70_02_MAC_ID			MESSAGE	
+Msg_GET_70_03_Serial_No			MESSAGE	
+Msg_GET_universal			MESSAGE	
+Msg_RESET_23			MESSAGE	
+Msg_SET_23_0C_Direction			MESSAGE	
+Msg_SET_23_10_Meas_Units			MESSAGE	
+Msg_SET_23_11_Total_Meas_Range			MESSAGE	
+Msg_SET_23_13_Preset_Value			MESSAGE	
+Msg_SET_70_02_MAC_ID			MESSAGE	
+Msg_SET_70_03_Serial_No			MESSAGE	
+POS_23_0A_Current_Position			DINT	Hex
+POS_23_0B_Position_Sensor_Type			INT	Hex
+POS_23_0C_Direction_Counting_Toggle			DINT	Hex
+POS_23_10_meas_units			DINT	Hex
+POS_23_11_Total_Measuring_range			DINT	Hex
+POS_23_13_Preset_Value			DINT	Hex
+POS_23_2A_Physical_Resolution_Span			DINT	Hex
+POS_23_2B_Number_of_Spans			DINT	Hex
+POS_23_2C_Alarms			INT	Hex
+POS_23_2E_Alarms_Flag			INT	Hex
+POS_23_31_Warning_Flag			INT	Hex
+POS_23_33_Offset_Value			DINT	Hex
+VAL_get_array			SINT[10]	Hex
+VAL_MAC_ID			SINT[6]	Hex
+VAL_Serial_No			DINT	Hex

Fig. 19: Controller tags

9.2.3. Configuration of the message tag

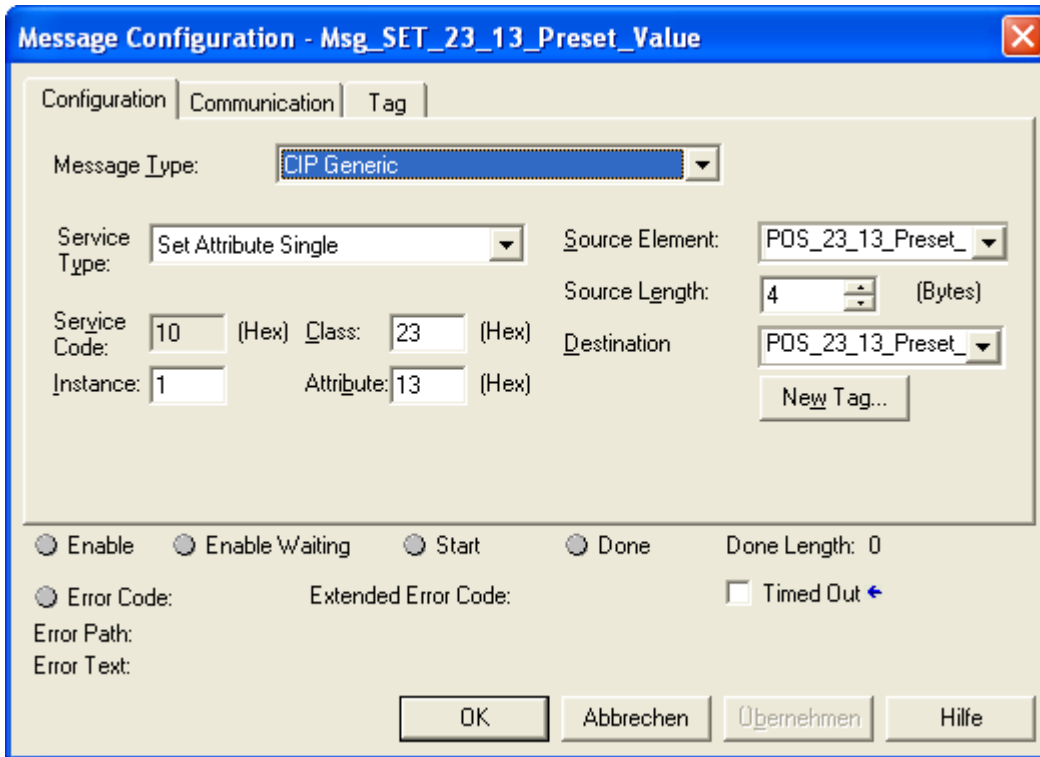

Fig. 20: Set Attribute Single message configuration

After downloading and running the PLC program, the preset command can now be executed with the button combination STRG-T.



Fig. 21: Activation of the preset command

Here, the current position of the encoder is set to the preset value.

10. Used abbreviations and terms

ARRAY	Field data type
Attr.	Attribute
BOOL	Data type which can only accept the values TRUE or FALSE
BYTE	Data type – 8 bit
CIP	Common Industrial Protocol
DINT	Signed 32-bit integer value
DWORD	Bit field – 32 bits
EMC	Electromagnetic compatibility
ERTEC	Enhanced Real-Time Ethernet Controller
h	Abbreviation for hexadecimal representation
hex	Abbreviation for hexadecimal representation
I/O	Input / output
IP	Internet protocol in conjunction with EtherNet/IP but industrial protocol
OSI reference model	Open Systems Interconnection Reference Model
ODVA	Open Device-Net Vendor Association
Packed EPATH	Data type – CIP path segments
PE	Potential earth
SHORT_STRING	Character string (1 byte per character, 1 byte length indicator) – Data type
STRING	Data type - .character string (1 byte per character)
STRINGI	International character string
STRUCT	Structure - data type
TCP	Transmission Control Protocol
UDINT	Unsigned 32-bit integer value
UDP	User Datagram Protocol
UINT	Unsigned 16-bit integer value
USINT	Unsigned 8-bit integer value
WORD	Bit field – 16 bits

11. FAQ's

11.1. Device not responding / IP address unknown

Device operation mode „IP address out of internal flash“.

The IP address is saved in the flash but unknown.

Encoder is not recognised in RSLinx. (Device not responding to PING command)

Troubleshooting:

- Disconnect device from power supply (device power off).
- Carefully undock the bus cover.
- At bus cover power-on (when undocked from basic encoder) the activity indicator (Duo- LED) is red continuous.
- Bus cover operational in mode „IP address via DHCP request“.
- In the NIC (network card) configuration, set „dynamic“ (DHCP enable).
- Run bus cover and NIC at BOOTP/DHCP server.
- NIC and bus cover IP address to be allocated within the same network.
- Bus cover now appears as bus user under RSLinx (device name: ERR_ see illustration below).
- Address bus cover as described under 7.2.
- Press button „**Enable DHCP**“.
- Device logs on with message „**Command successful**“.
- Disconnect bus cover from power supply.
- Dock bus cover onto basic encoder again.
- After power on, the device is operational in mode „IP address via DHCP request“.

IP addressing in operation „bus cover without basic encoder“ to RSLinx and BOOTP/DHCP server

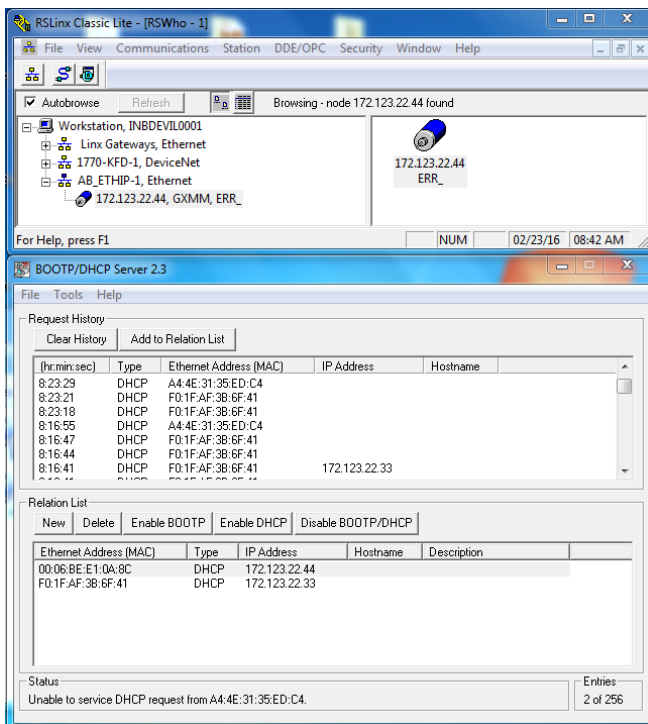

Devices with rotary switches:

- Carefully undock bus cover from basic encoder.
- Rotary switch setting unequally 00, for example 22.
- Device now in mode „IP address by HEX rotary switch“.
- In the present example, the encoder will respond again to address 192.168.1.22.