

Overview

- Gigabit Ethernet interface cable
- CAT6A
- M12/8-pin connector, X-coded (screw lock), 90° angled to RJ45
- cable carrier compatible
- suitable for robotic applications (+/- 180°/ 0.5 m, min. 1.000.000 torsion cycles)
- length 5,0 m



Picture similar

Technical data

Electrical data

Number of poles	8
Connectors	M12/x-kodiert, gewinkelt, verschraubbar RJ45

Mechanical data

Smallest bending radius static	70 mm
Bending cycles	1000000
Use in cable carriers	yes, flexible cable
Cable length [m]	5 m

Mechanical data

Weight	≤ 350 g
Material	TPU, halogen-free

Interface

Data interface	10 GigE GigE
----------------	-----------------

Environmental conditions

Conformity	RoHS CE
Protection class	IP 40

Dimension drawing

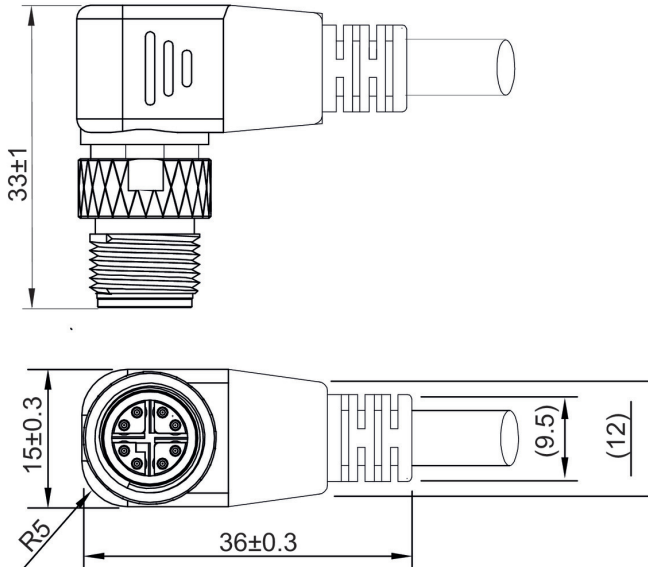

Pin assignment

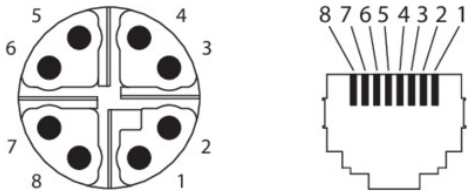

M12	RJ45	M12	RJ45
1:	1	7:	5
2:	2	8:	4
3:	3	5:	7
4:	6	6:	8