



Operating Manual

CM50I.PN
IO-Link Master with PROFINET

EN-US

1 About this document

1.1 Purpose and scope of application

This document instructs the technical staff of the machine manufacturer or machine operator on the safe use of the described devices.

It does not include instructions on the safe use of the machine in which the devices are integrated. Information on this is found in the operating manual of the machine.

- Read this chapter carefully before you start working with the device.
- Study the documentation carefully before device commissioning.
- Store the manual in a place that is accessible to all users at all times for the entire service life of the device.

Understanding the present manual requires general knowledge about automation technology. In addition, planning and using automation systems requires technical knowledge which is not included in this manual.

1.2 Applicable documents



- Available for download at www.baumer.com:
 - Instruction manual
 - Data sheet
 - Device description file
 - EU Declaration of Conformity
 - Certificates and Approvals
- Attached to product:
 - General information sheet (11042373)

1.3 Labels in this manual

Identifier	Usage	Example
<i>Dialog element</i>	Indicates dialog elements.	Click OK .
<i>Unique name</i>	Indicates the names of products, files, etc.	<i>Internet Explorer</i> is not supported in any version.
Code	Indicates entries.	Enter the following IP address: 192.168.0.250

1.4 Warnings in this manual

Warnings draw attention to potential personal injury or material damage. The warnings in this manual indicate different hazard levels:

Symbol	Warning term	Explanation
	DANGER	Indicates an imminent potential danger with high risk of death or serious personal injury if not being avoided.
	WARNING	Indicates potential danger with medium risk of death or (serious) personal injury if not being avoided.
	CAUTION	Indicates a danger with low risk, which could lead to light or medium injury if not avoided.
	NOTE	Indicates a warning of material damage.
	INFO	Indicates practical information and tips that enable optimal use of the devices.

1.5 Scope of delivery

Delivery includes:

- 1 x *CM50I* device
- 1 x instruction manual - multilingual
- 15 x designation label

1.6 Trademarks

The present documentation uses the trademarks of the following companies and institutions:

<i>PROFINET/PROFINET IO</i>	PROFIBUS Nutzerorganisation e.V. (PNO)
<i>EtherNet/IP</i>	ODVA, Inc.
<i>IO-Link</i>	c/o PROFIBUS Nutzerorganisation e.V. (PNO)
<i>STUDIO 5000 LOGIX DESIGNER</i>	Rockwell Automation Inc.

1.7 Software-Tools

Applied software
<i>Totally Integrated Automation (TIA) Portal</i> of Siemens AG
<i>Studio5000</i> , Rockwell Automation Inc
<i>Baumer Sensor Suite (BSS)</i>

1.8 Specifications

Specification	Link
<i>GSDML Technical Specification for PROFINET IO</i> Version 2.34 of 08.2017	www.profibus.com
<i>PROFINET</i> Specification V2.4	www.profibus.com
<i>IO-Link</i> Version 1.1.2 of 07.2013	www.io-link.com



INFO

The features of IO-Link specification V 1.1.3 are supported.

2 General information

Intended use

This product is a precision device and serves the detection of items, objects, or physical measurement variables and the preparation or provision of measured values as electric variables for the higher-level system.

Unless specifically labeled, this product may not be used in explosive environments.

Commissioning

Assembly, installation, and calibration of this product may only be performed by a specialist.

Installation

Only use the fasteners and fastener accessories intended for this product for installation. Outputs not in use must not be wired. Unused wires of cable outputs must be insulated. Do not go below the permissible cable bending radii. Disconnect the system from power before the product is electrically connected. Use shielded cables to prevent electro-magnetic interference. If the customer assembles plug connections on shielded cables, then EMC-version plug connections should be used and the cable shield must be connected to the plug housing across a large surface area.

Disposal (environmental protection)



Used electrical and electronic devices may not be disposed of in household waste. The product contains valuable raw materials that can be recycled. Therefore dispose of this product at the appropriate collection point. For additional information visit www.baumer.com.

3 Safety

3.1 General safety instructions



⚠ DANGER

High electrical voltage in the machine/system.

Death or severe injuries resulting from electric shock.

- a) While working on the machine/devices, comply with the five safety rules of electrical engineering.

Protection of persons and material assets

- According to DIN VDE 0105-100 - Operation of electrical systems - Part 100: General definitions

The 5 Safety Rules

Protect against *high electrical voltage*

1. Switch off the device.
2. Secure against unwanted switchon.
3. Ensure that each pole is not live respectively under voltage.
4. Grounding and short-circuiting.
5. Cover or block neighboring parts under voltage.

Qualified personnel

The appliance may only be installed, commissioned and operated by qualified personnel who have received safety training.

Qualified means fulfilling the following requirements:

- the personnel underwent suitable training in electrical engineering,
- the personnel is familiar with the safety standards which are common practice in automation engineering,
- the personnel has access to the Operating instructions and the present Instruction Manual,
- are familiar with the safety standards of automation technology,
- the personnel is familiar with the related and applicable basic and technical standards.

Intended use of the device

- During project engineering, installation, commissioning, operation, and testing of the device comply with the existing regulations on accident prevention as well as health and safety at work.
- Check material resistance against aggressive media.



INFO

Any manipulation/modification of hardware and software only qualified *Baumer* personnel, except for firmware updates.

**INFO**

Only use a power unit of max. 60 V DC respectively 25 V AC in single fault condition. Power supply must comply with *SELV* or *PELV*.

Protective measures by the machine operator

- Follow the instructions in this manual.
- Observe the specifications and operating instructions of each connected component.

4 Description

4.1 Device

CM50I.PN

- *PROFINET* compact module, plastic
- *PROFINET* encoding via M12 -D- encoding
- Power via M12 L- encoding, 5-pin
- 8x M12 slots, digital inputs/outputs/8 IOL, A-encoding



4.1.1 Device structure

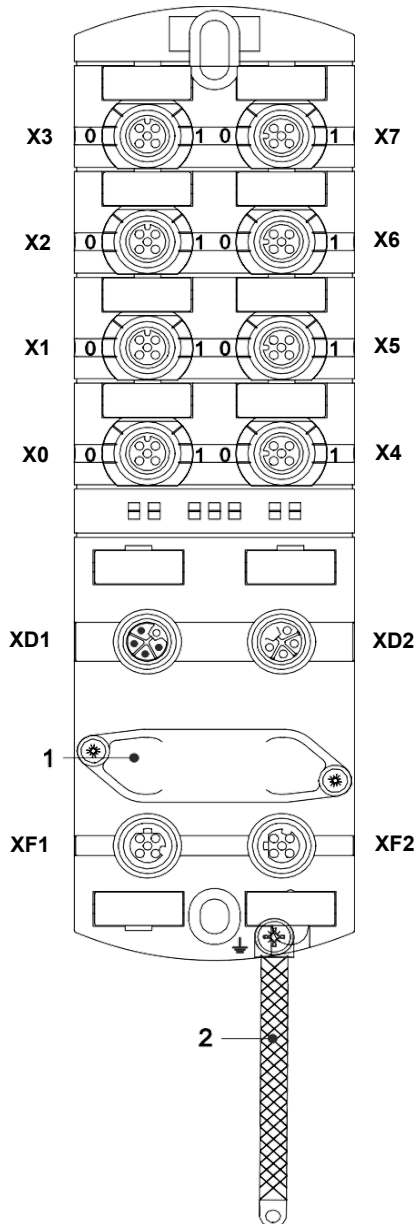

- X0 ... X7** Digital I/O or IO-Link
 - M12 A-encoding
 - 0 Channel corresponds to pin 4
 - 1 Channel corresponds to pin 2
- Examples:
 - Channel **02** = **Pin 4** port X2
 - Channel **16** = **Pin 2** port X6
- XD1** Power supply POWER IN, M12 L-encoding 5-pin
- XD2** Power supply POWER OUT, M12 L-encoding 5-pin
- 1** Rotary switch
- XF1** Ethernet Port 1, M12 D encoding
- XF2** Ethernet Port 2, M12 D encoding
- 2** Ground strap for functional ground

4.1.2 Product name nomenclature

The nomenclature is based on a scheme indicating the product functionality.

CM50I	Product family
PN	Industrial Ethernet Protocol <ul style="list-style-type: none"> ■ PROFINET

4.1.3 Pin assignment

M12 female connector A-encoding

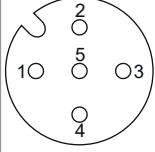
X0 ... X7		
	Pin 1	24V Us
	Pin 2	DIO / 24V Ua
	Pin 3	0V
	Pin 4	C/Q
	Pin 5	0V

M12 male/female connector, POWER IN/OUT

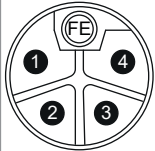
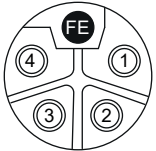
XD1			XD2
	Pin 1	24V Us	
	Pin 2	0V	
	Pin 3	0V	
	Pin 4	24V Ua	
	Pin 5	FE	

M12 female connector D-coded port 1 / port 2

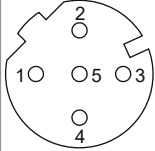
XF1 / XF2		
	Pin 1	Tx +
	Pin 2	Rx +
	Pin 3	Tx -
	Pin 4	Rx -
	Pin 5	n.a.
	Shield	FE

4.1.4 Display elements

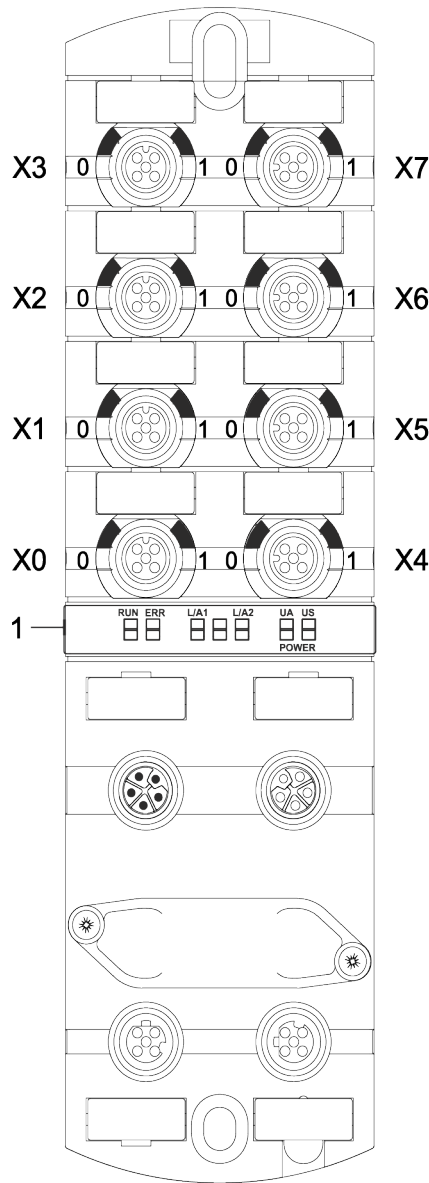

X0 ... X7 LED digital I/O or IO-Link

- 1 LED BUS RUN
- LED CfgF
- LED LNK1/ACT1
- LED LNK2/ACT2
- LED Status (ST)
- LED POWER UA
- LED POWER US

Also see about this

[LED indicator \[▶ 115\]](#)

4.2 IO-Link

Within the IO-Link standard, smart devices at sensor and actuator level connect to automation systems.

Communication takes place between the IO-Link master and one or more IO-Link peripheral devices. Each port connects a single device. IO-Link is a point-to-point communication standard, not a fieldbus system.

The IO-Link Master acts as interface between the superior fieldbus level and the IO-Link devices.

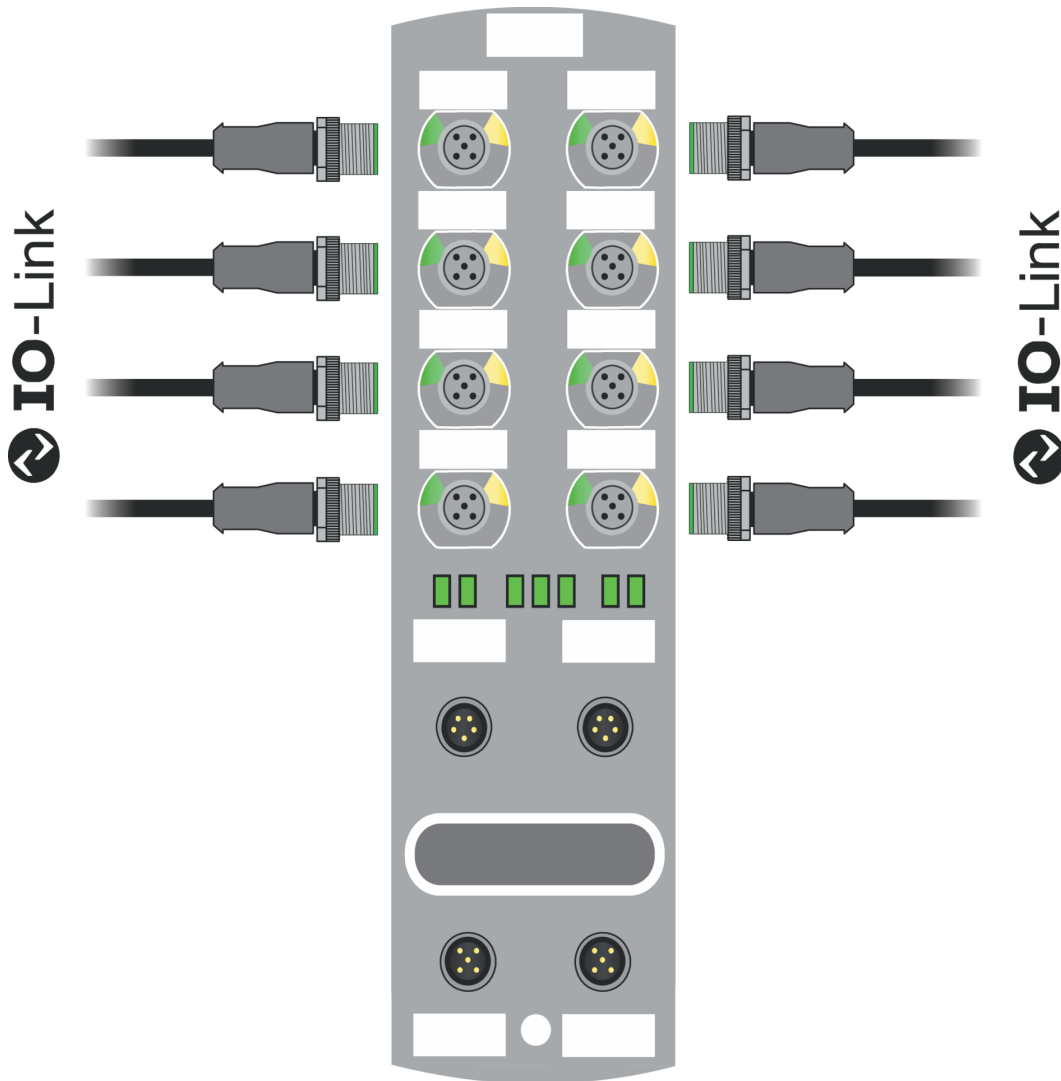

III. 1: IO-Link

IO-Link-Mode (IOL)

The IO-Link communication (C/Q) is assigned to pin 4, for connection and use of an IOL device.

Acyclic data may serve for writing device parameters of a IO-Link device or for reading parameters, measured values and diagnostic data from a IO-Link device.

IO-Link CALL

The following tasks can be performed:

- Parameterization/configuration of IO-Link devices during operation.

- Diagnostic of IO-Link devices by reading diagnostic parameters.
- Execute IO-Link port functions.
- Back-up/recovery of IO-Link device parameters.

IO-Link device data are uniquely addressed via index and sub-index.

Such data can be accessed with the so-called IOL CALL block. Usually, it is provided as data handling block by the PLC manufacturer.

IO-Link CALL

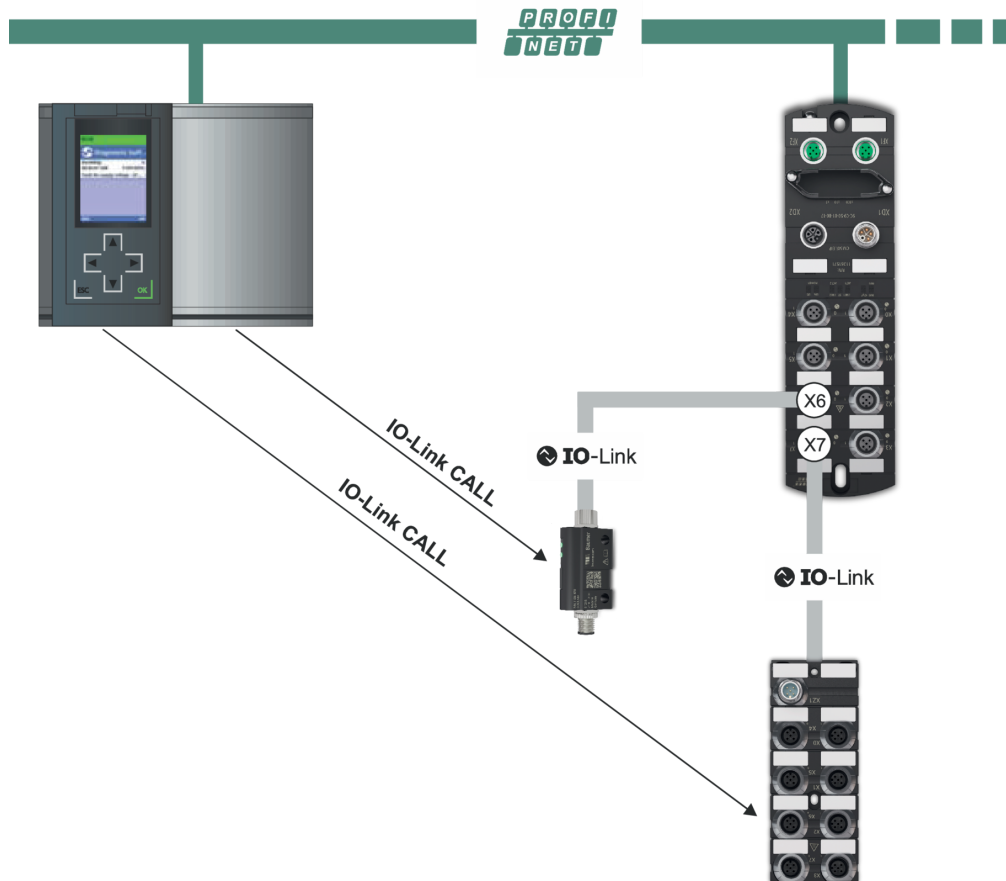

///. 2: IO-Link CALL

Also see about this

[IO-Link configuration \[▶ 70\]](#)

4.2.1 Data storage



INFO

Data storage is only available for IO-Link devices compliant to IO-Link version V1.1 and higher.

- Data storage allows for replacing IO-Link devices without the need for new configuration.
- IO-Link master and IO-Link device save the parameterization of the previous device.
- Data storage synchronizes the data memories of IO-Link master and IO-Link device.
- Once the IO-Link device has been replaced, the master will write the saved parameters into the new device, provided data storage is enabled in the IO- Link Master.
- This allows for application restart without parameterization from scratch.
- When replacing the IO-Link master, the new Master will read parameterization out of the IO-Link device and save it. Doing so requires the data storage option “Save and restore” being enabled.
- This allows for application restart without parameterization from scratch.
- For data storage application, vendor ID and device ID of the connected IO-Link device must be entered in the validation settings of each IO-Link master port.
- The IO-Link port mode must be set to “Manual”.
- To store the modified IO-Link device parameters again in the master, de- vice parameteriza- tion must be done via block parameterization.
 - After this, the device transmits an upload request to the Master.
 - Block parameterization can be carried out via the IO-Link device tool in the “Parameter” window and with the “Block Write Mode”.
 - Optionally, block parameterization can be done by device parameter writing via web server or PLC block, e.g. Siemens IOL_Call.
 - Always terminate block parameterization with command "Parameter Download Store" ISDU Index 0x02 Subindex 0 Value 05.
- In validation/backup mode “no Device check”, the saved device parameter content in the IO-Link master is deleted.

4.3 PROFINET IO

4.3.1 PROFINET IO Communication

IEC 61784-2

PROFINET IO is an open communication protocol compliant to *IEC 61784-2*. The communication protocol is based on Ethernet.

Data exchange

Data is exchanged between the control unit, the so-called *PROFINET IO* Controller and the connected users called *PROFINET IO* devices.

Communication

Communication is based on a full-duplex Ethernet network with 100 Mbit/s or 1 Gbit/s. IO controller and IO devices communicate by Ethernet telegrams. Devices exchange data cyclically based on the provider-consumer principle. Devices function as receiver (consumer) and transmitter (provider) at the same time.

The IO controller sends output data to the IO devices and receives input data from the IO devices. The IO devices send input data and receive output data.

Other components of the communication protocol include telegrams in form of acyclic communication for parameter transfer and read/write access to the I&M data or manufacturer-specific features.

4.3.2 Structure of the conformance classes

Structure

The scope of functions of *PROFINET IO* classified in *Conformance Classes (CC)*. These classes give a clear overview of the various minimum properties. There are three conformance classes:

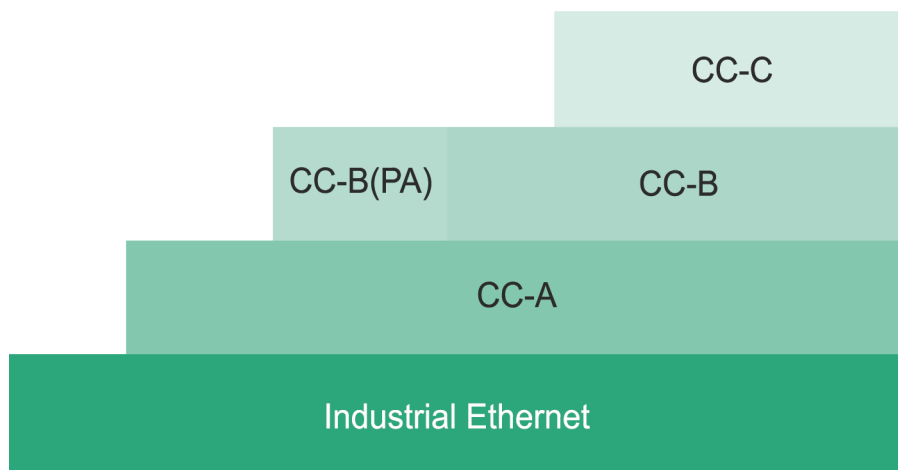

III. 3: Structure of the conformance classes

CC-A

CC-A offer basic functions for *PROFINET IO* with RT communication. Typical cycle times are 2 ms and more. Also unmanaged switches can also be used. Wireless communication is only enabled in this class.

All I *CM501.PN* comply with the **CC-A** class.

All *Baumer* switches (unmanaged and managed) can be used.

CC-B

CC-B expands the concept by the inclusion of network diagnostics and topology information. Typical cycle times are 2 ms and more. Topology information and projected device names enable easy device exchange. The defective device can be easily exchanged by a new device with factory settings. All *CM501.PN* comply with the **CC-B** class.

CC-C

CC-C describes the basic functions for devices with hardware-supported bandwidth reservation and synchronization (IRT communication) and hence is the basis for isochronous applications. Implementing Isochronous Real Time (IRT) in Ethernet controllers allows for update times of 31.25 μ s and jitter accuracy of less than 1 μ s.

4.3.3 Media redundancy (MRP)

The Media Redundancy Protocol (MRP) according to IEC 62439 describes the *PROFINET* redundancy with a typical reconfiguration time of <200 ms for communication paths with TCP / IP and RT frames after the occurrence of error. Failure-free operation of automation systems implies a Media Redundancy Manager (MRM) and several Media Redundancy Clients (MRC) in a ring arrangement.

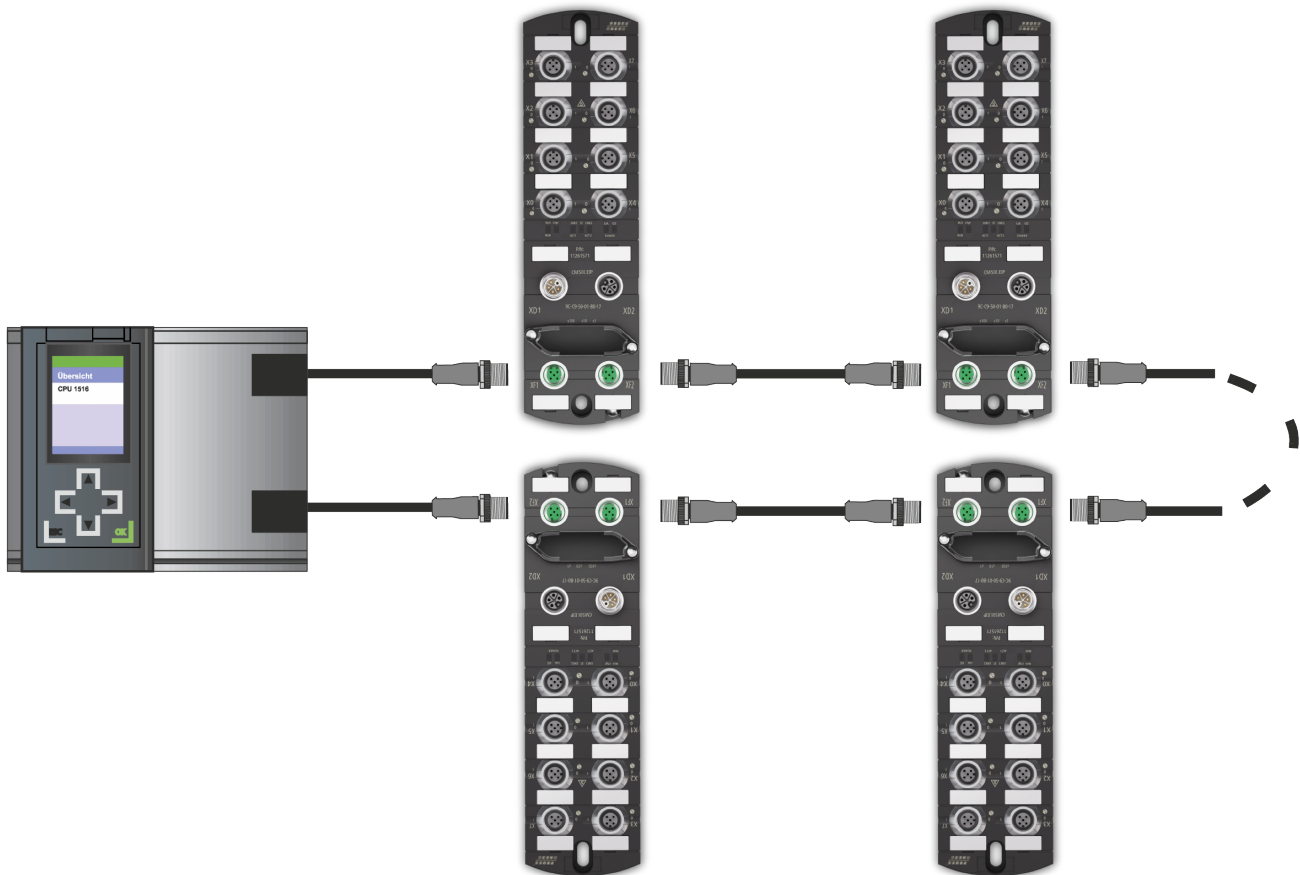

III. 4: Standard operation

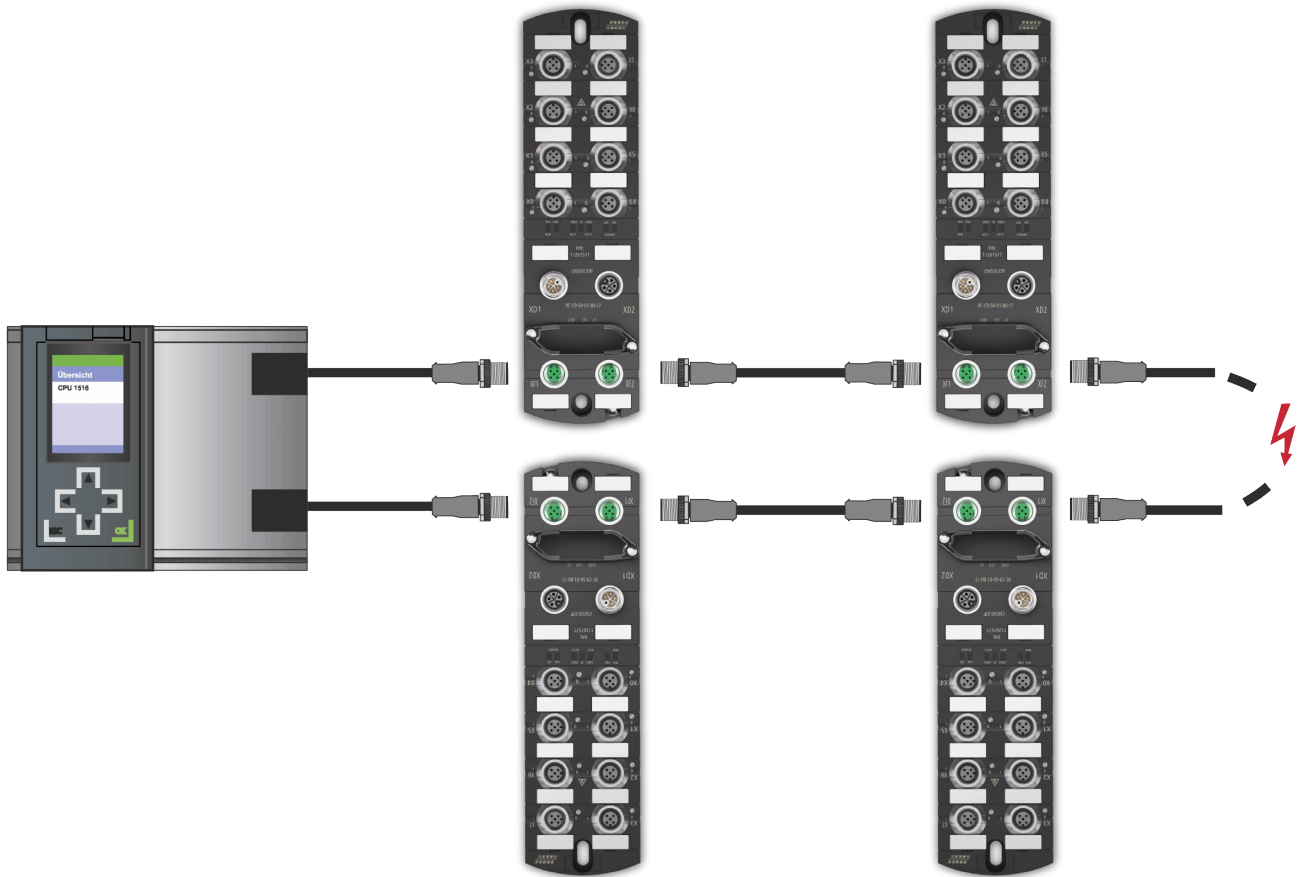

III. 5: Malfunction

Function of Media Redundancy Manager (MRM)

The function of a Media Redundancy Manager (MRM) is to check the operability of the ring structure specified by the configuration. This is done by cyclic transmission of telegrams. As long as the MRM is receiving the test telegrams, the ring structure is intact. The MRM uses this behavior to prevent telegram circulation and converts the ring structure into a line structure.

Media Redundancy Clients (MRC) are switches acting as so-called “telegram transfer hatch” and usually do not play an active role.

MRC must provide two switch ports to connect to other MRCs or the MRM in a single ring. Devices can be configured as MRC. When being interrupted from the ring, *PROFINET* communication is continued after reconfiguration.

Also see about this

[Media Redundancy Protocol \(MRP\) configuration \[▶ 85\]](#)

4.3.4 Isochronous-Real-Time (IRT)

In *PROFINET* communication, the IRT concept (Isochronous-Real-Time) defines , isochronous data exchange by transmission of data frames at regular time intervals ranging from few hundred milliseconds up to four milliseconds.

The beginning of a bus cycle is adhered to with the highest precision (jitter $\leq 1 \mu\text{s}$). Each of the individual time intervals in IRT communication is split into an IRT interval and an open standard interval; this requires special IRT switches.

Communication cycle using IRT and RT

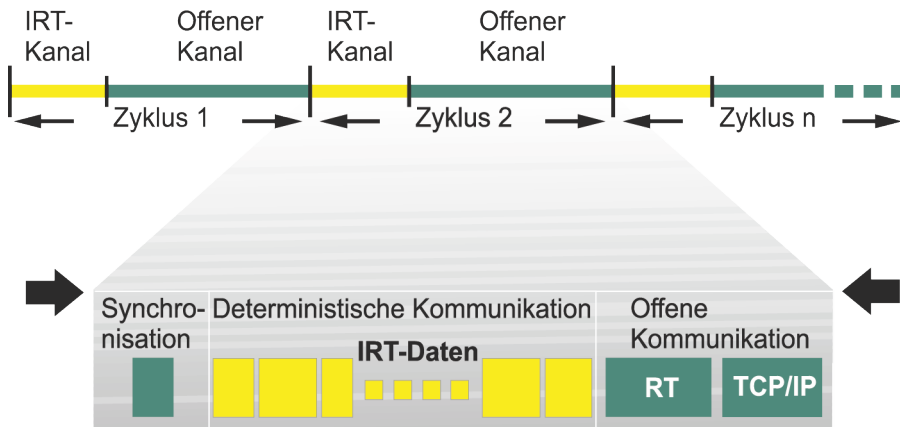

III. 6: Communication cycles split into IRT and RT

Also see about this

[Isochronous-Real-Time \(IRT\) configuration \[▶ 88\]](#)

4.3.5 I&M data

Identification and Maintenance (I&M)

The I&M function is a standard of the PROFIBUS Nutzerorganisation e.V (PNO) and a prerequisite for high-performance asset management.

Identification data

Identification data (I data) provides device information, such as order or serial number. Sometimes, this information can be seen on the device housing. I-data is manufacturer-specific device information. They provide read access only.

Maintenance data

Maintenance data (M data) is system-specific information, such as installation site and date. M-data is created during projecting, written into the remanent memory of the device.

Also see about this

[I&M-Daten \[▶ 72\]](#)

4.4 Simple Network Management Protocol (SNMP)

SNMP is a simplified network protocol with varied objects for monitoring the following:

1. Network components,
2. Remote control and configuration of network components,
3. Error detection and error messaging.

TCP/IP based network components relate to standard RFC 1213. This standard describes the access options and structure of the corresponding objects.

Also see about this

 [Simple Network Management Protocol \(SNMP\) \[▶ 90\]](#)

4.5 Industrial Internet of Things (IIoT)

The device supports the following IIoT functions for industrial communication: *JSONMQTT* and OPC UA.

5 Technical data

5.1 Electrical Data

IIoT functions		
Web Interface	http://	Yes
OPC UA	For IO-Link according to Companion Specification Release 1.0	Yes
OPC UA	Transport	UA TCP, UA Secure Conversation, UA Binary Encoding
OPC UA	Minimum release interval	100 ms
OPC UA	Maximum number of sessions/clients	5
JSON	JSON integration for IO-Link V1.0.0	Yes, via REST API and MQTT
Energy monitoring	Current and voltage	Yes
Temperature monitoring		Yes
Bus data		
Fieldbus protocol		PROFINET
Connection		4-pin M12, D- encoding
PROFINET Conformance Class		C
Transmission rate		100 Mbit/s
PROFINET addressing		Via DCP
Cycle time		≥1 ms
IRT	Network communication	Yes
	Application	No
MRP	Client	Yes
SNMP		Yes
PROFINET Netload Class		III
IO-Link		
Operating voltage IO-Link devices		24 V □
Voltage range IO-Link devices		20 ... 30 V □
Transmission rate		COM1 / COM2 / COM3
Standardized Master Interface (SMI)		According to IO-Link Specification V1.1.3
Transmission rate recognition		Automatic

Supply		
Operating voltage US		24 V □
Voltage range US		18 ... 30 V □
	When using IO-Link	20,3 ... 30 V □
Operating voltage UA		24 V □
Voltage range UA		18 ... 30 V □
Sensor current US	≤40 °C (see Derating)	≤16 A
Actuator current UA	≤40 °C (see Derating)	≤16 A
Current consumption	At idle	≤0,18 A
Protection against reverse polarization for US and UA		Yes
Reverse polarity protection		Yes
Connection		5-pin M12, L-encoding
Conductor cross-section	Current per supply ≤12 A	≥1.5 mm ²
	Current per supply >12 A	≥2.5 mm ²
Input (DI)		
Sensor supply +	Per port, ≤40 °C (see Derating)	≤2 A load Automatic start
Total current sensor supply	≤40 °C (see Derating)	≤10 A
Filter time		0 ... 15 ms + tcycle, adjustable
Delay time at changed signal		2 ... 5 ms
Input characteristic	EN 61131-2	Type 1 + Type 3
Short-circuit protection sensor supply		MOSFET with current measurement
Connection		5-pin M12, A-encoding
Cable cross-section M12		≤0.75 mm ²
Cable length		≤30 m
Total current	Per port	≤4 A
Output (DO)		
Output current DO (UA)	Per pin, ≤40 °C (see Derating)	≤2 A
Total current outputs	≤40 °C (see Derating)	≤10 A
Switching frequency		≤50 Hz
Short-circuit protection actuator		MOSFET with current measurement
Connection		5-pin M12, A-encoding
Cable cross-section M12		≤0.75 mm ²
Cable length		≤30 m
Total current	Per port	≤4 A

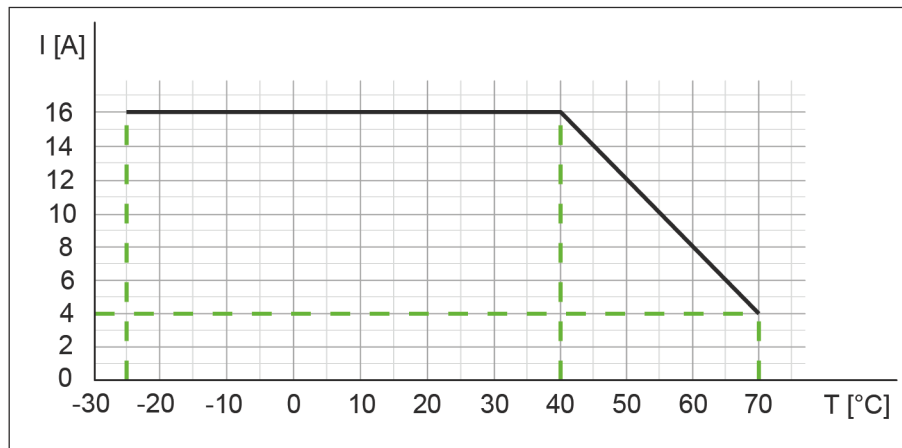
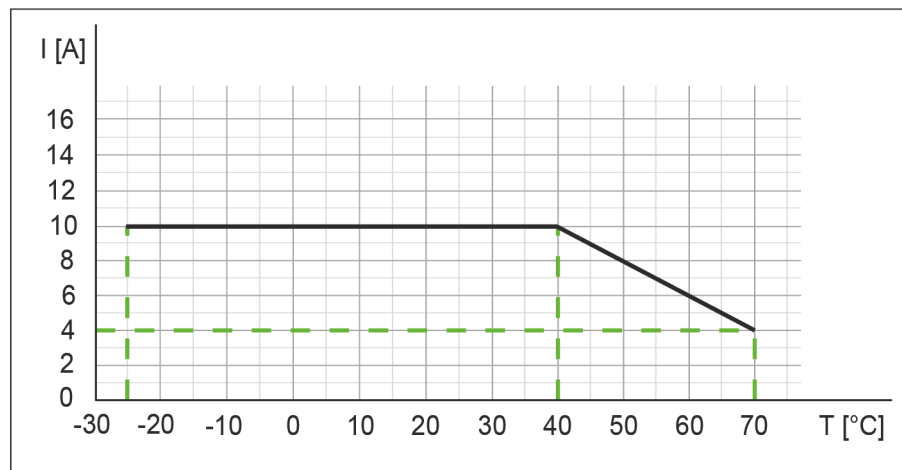
Derating sensor current I_{US} / actuator current I_{UA} III. 7: Derating sensor current I_{US} / actuator current I_{UA} **Derating total current, sensor power supplies/outputs total current**

III. 8: Derating total current, sensor power supplies and total current, outputs

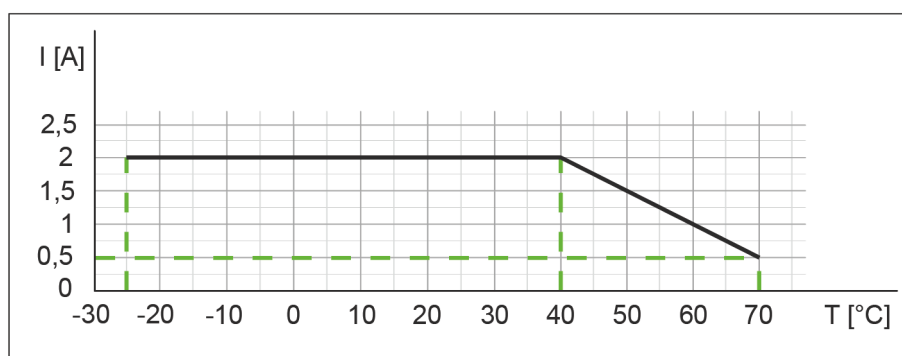
Derating current per sensor supply/output

III. 9: Derating current per sensor power supply and output

5.2 Ambient conditions

Climate		
Operating temperature		-25 °C ... +70 °C
Storage temperature	Ensure acclimatization for commissioning	-25 °C ... +85 °C
Transport temperature	Ensure acclimatization for commissioning	-25 °C ... +85 °C
Relative humidity		≤95 %
Installation hight	Above sea level	≤3000 m
Mechanical		
Oscillation test	EN 60068 Part 2-6	10 ... 58 Hz, amplitude 0.35 mm, 58 ... 150 Hz; 20 g
Shock test	EN 60068 Part 2-27	50 g for 11 ms
Electrical safety		
Protection	EN 60529	IP67
Protection rating	Using a SELV- or PELV- power supply	III
Level of contamination		2
EMC emission		
Radiated inteference E-field housing enclosure	EN 55016-2-3	Compliant
EMC-immunity		
Electrostatic discharge (ESD)	EN 61000-4-2	Compliant
Electromagnetic RF-fields	EN 61000-4-3	Compliant
Fast transient burst	EN 61000-4-4	Compliant
Shock tension surge	EN 61000-4-5	Compliant
Conducted RF-fields	EN 61000-4-6	Compliant
Voltage dips	EN 61000-4-11	Compliant

5.3 Protection

Device protection		
Overvoltage protection		Yes
Overload protection device supply	To be ensured by load circuit monitoring	Yes
Inverse-polarity protection device supply		Yes
Short-circuit protection sensor supply		Electronically
Short-circuit protection output		Electronically
Protective circuit input	Internal	Suppressor diode

5.4 Mechanical data

Material data		
Housing material		Plastic
Mounting data		
Weight	Net	470 g
Dimensions	L x W x H	225,4 x 63 x 36 mm

5.5 Conformity, Approvals

Conformity, Approvals		
Product standard	EN 61131-2 Programmable Logic Controllers Part 2	Compliant
CE	2014/30/EU 2011/65/EU	Compliant
UKCA		Compliant
EMC	2014/30/EU	Compliant
REACH	No. 1907/2006	SVHC List
WEEE	2012/19/EU	Compliant
ULus		E201820
RoHS	2011/65/EU & 2015/863	Exception 6c&7a
China RoHS	SJ/T 11364-2014	25 EPUP

Hazardous substance (有害物質)							
	Part Name	Lead	Mercury	Cadmium	Hexavalent	Polybrominated	Polybrominated
	零件名稱	(Pb) 鉛	(Hg) 汞	(Cd) 鎘	Chromium (Cr (VI)) 六价铬	biphenyls (PBB) 多溴联苯	diphenyl ethers (PBDE) 多溴联苯醚
	Component part PCB 组件部分 印刷电路板	X	O	O	O	O	O
	Connection Terminal/ Screws 接线端子 / 拧	X	O	O	O	O	O
<p>O: Indicates that the content of the harmful substance in all homogeneous materials of the component part is below the limit defined in GB/T 26572.</p> <p>O: 表明該有害物質在組成部分的所有均質材料的含量低於按GB/ T26572定義的限制。</p> <p>X: Indicates that the content of the harmful substance in at least one homogeneous material of the component part exceeds the limit defined in GB/T 26572.</p> <p>X: 表示該有害物質在組成部分中的至少一個均質材料的含量超過按GB / T26572定義的限制。</p>							

6 Installation

6.1 Requirements

Installation requirements:

- Even mounting surface to avoid mechanical tension.
- Provide proper grounding.
- Suitable installation site in terms of vibration and shock load, temperature and humidity (see [Technical data ▶ 20](#)).
- Protected site to prevent connection cables from being torn off accidentally.

6.2 Dimensions

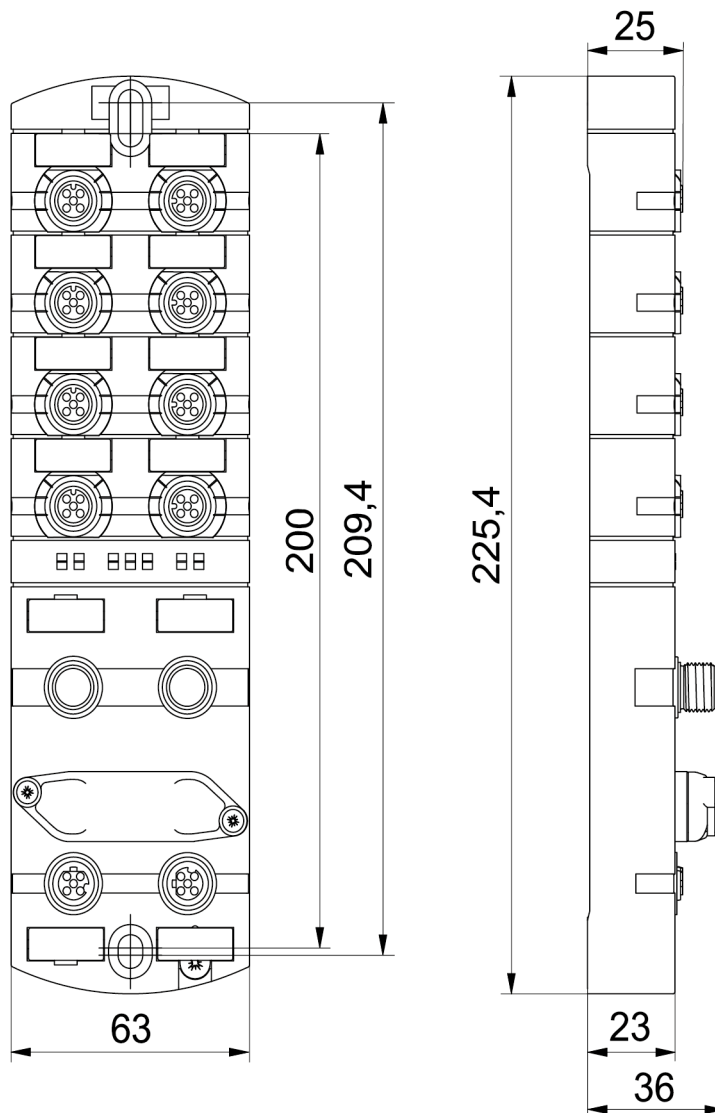

III. 10: Dimensions in mm

6.3 Mounting distance

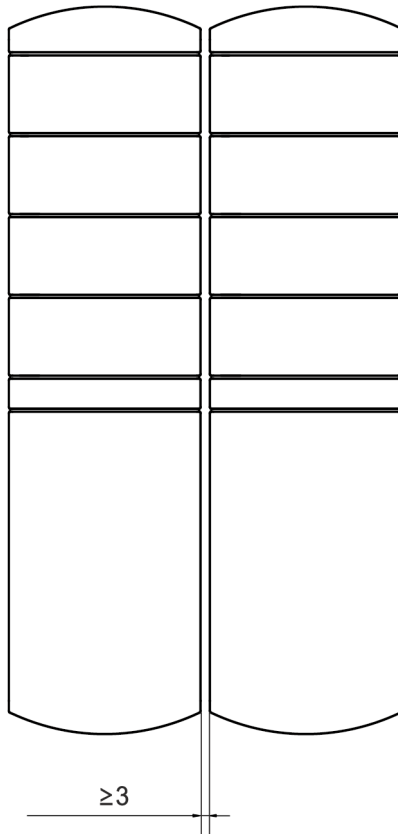

III. 11: Distance in mm

**INFO**

For proper installation and improved heat dissipation, we recommend maintaining a minimum distance of 3 mm when installing *CM50I*.

**INFO**

Minimum distance of 50 mm required where using angled connectors.

6.4 Mounting the device



⚠ WARNING

Material damage due to incorrect installation.

Use fastening screws that are appropriate for the mounting surface.

- a) Fastening screws and tightening torques depend on mounting surface.
- b) Tighten the screws carefully. Observe the specified tightening torques.



⚠ WARNING

Material damage through improper use.

Do not use the devices as climbing aids. Devices may come off by improper use or might be damaged.

- a) Install the device in such a way that it cannot be used as climbing aid.

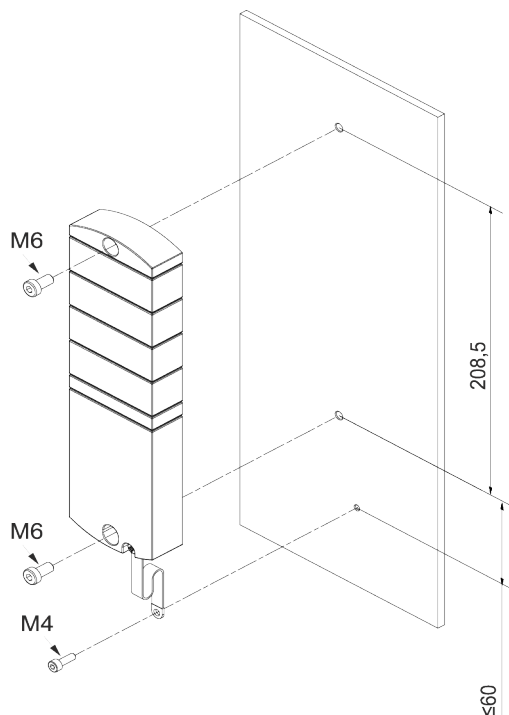

Ill. 12: Fasten the device. Dimensions in mm (illustration similar)

M6	3 Nm		Art.-No. 7000-98001-0000000
----	------	---	--------------------------------

When mounting the device, observe the order indicated below:

- a) Slightly tighten the top M6 screw.
- b) Align the housing.
- c) Slightly tighten the lower M6 screw.
- d) Tighten both M6 screws to the specified torque.
- e) *Device grounding*: Attach grounding strap (see [Functional ground \[▶ 28\]](#)).



INFO

The screws and grounding strap of the illustration are not included in the delivery.

6.4.1 Functional ground



INFO

Use a conductive screw to attach the grounding strap.

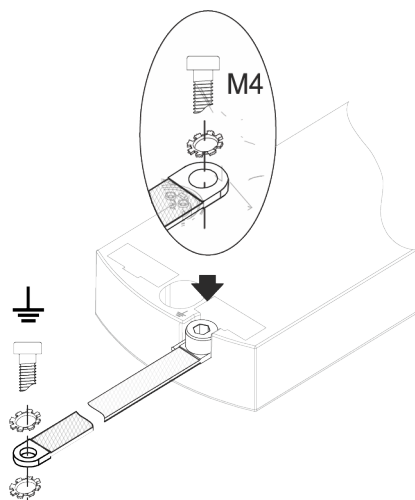

III. 13: Attach the grounding strap

Tool

- M4
- ♦ Tighten the screw at 1.2 Nm \pm 0.1 Nm.



INFO

The screws and grounding strap of the illustration are not included in the delivery. The grounding strap is available at the Baumer Website <http://baumer.com>.

Also see about this

[Accessories \[▶ 141\]](#)

6.4.2 Addressing lid

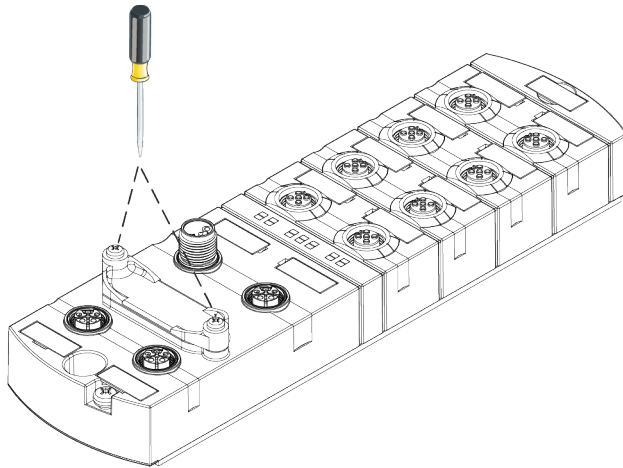

III. 14: Attaching the addressing lid

Tool

- ● M3

Instruction:

- ◆ Tighten the screws at 0.8 Nm \pm 0.1 Nm fest.

7 Installation

7.1 Electrical installation of the device

DANGER

High electrical voltage in the machine/system.

Death or severe injuries resulting from electric shock.

- a) While working on the machine/devices, comply with the five safety rules of electrical engineering.

Protection of persons and material assets

- In accordance with *DIN VDE 0105-100 - Operation of electrical installations - Part 100: General requirements*

WARNING

Risk of fire due to short circuit.

Supply lines and/or devices may short circuit when damaged causing overheating and fire.

- a) Ensure smart current monitoring or fuse
The fuse must be able to hold max. 9 A.

CAUTION

Loss of function due to improper installation.

Failure to observe may result in personal injury and/or damage to property.

- a) Only use cables and accessories compliant to the requirements and relevant regulations for safety, electromagnetic compatibility and, if required, telecommunication end devices and specifications.



CAUTION

Hot surface.

Minor personal injuries and damage to the device when contacting hot surfaces.

- a) Wear suitable isolating gloves.
- b) Only use connection cables that meet thermal requirements.

CAUTION

Damage to machine/system by improper voltage on/off.

Switching on the device by separate actuator and sensor voltage, the functions of the digital inputs and outputs cannot be guaranteed.

- a) For device switch-on observe the following order:

- a) Switch on sensor voltage.
- b) Switch on actuator voltage.



INFO

Only use a power unit capable of limiting voltage to max. 60 VDC resp. 25 AC at the occurrence of error. Power supply must comply with SELV or PELV.

7.1.1 Rotary switch settings



INFO

Factory defaults : Rotary switch position is **000**.



INFO

An unambiguous and unique IP address must be assigned to each user in the network.

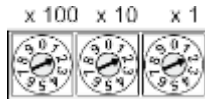

Address range 1 ... 999

x1	Rotary switch (units)
x10	Rotary switch (tens)
x100	Rotary switch (hundreds)

Tab. 1: Rotary switch for addressing

Position/ Range	Web server	JSON	OPC UA	MQTT	Description	
0	-	-	-	-	Standard operation	
001 ... 910	-	-	-	-	Reserviert**	
911	Disabled	Disabled	Disabled	Disabled	Secure Mode	Fieldbus communication in standard operation
912	-	Disabled	Disabled	Disabled	IloT mode disabled	
913	Disabled	-	-	-	Web server disabled	
914	Enabled	Enabled	Enabled	Enabled	Enables all IloT protocols and web server.	
915-978	-	-	-	-	Reserved	
979	Enabled	Enabled	Enabled	Enabled	Restore default	Sequence of actions only for this rotary switch position: <ol style="list-style-type: none"> 1. Disconnect device from power supply. 2. Set switch to position 979. 3. Connect device to power supply. 4. Wait for at least 2 minutes. 5. Disconnect device from power supply. 6. Set switch to position 000 or any other required. 7. Connect device to power supply.
980-999	-	-	-	-	Reserved	

Tab. 2: Setting the address

**INFO**

Reserved switch positions do not enable fieldbus communication, see [LED indicator \[▶ 115\]](#).

Service settings

Switch positions 911, 912 and 913 disable the device services marked in the "set address" matrix. With these settings, the switching behaviour of the device is according to the previous address configuration without limiting any functions, except the services disabled by this switch position. The services disabled by doing so could not be re-enabled in any other way, e.g. via the control's configuration parameters.

Switch position 914 will enable all services again. Again, the device functionalities are not limited.

1. Connect device to power supply.
2. Disconnect supply.
3. Set original address.

Setting the address**Setting the address**

1. Disconnect device from supply.
2. Remove addressing lid.
3. Set an address which is unique.
4. Fasten addressing lid again.
5. Connect device to power supply.

**INFO**

For appropriate tightening torque see [Addressing lid \[▶ 29\]](#).

7.1.2 Sensors and actuators

Connection of M12 female connector

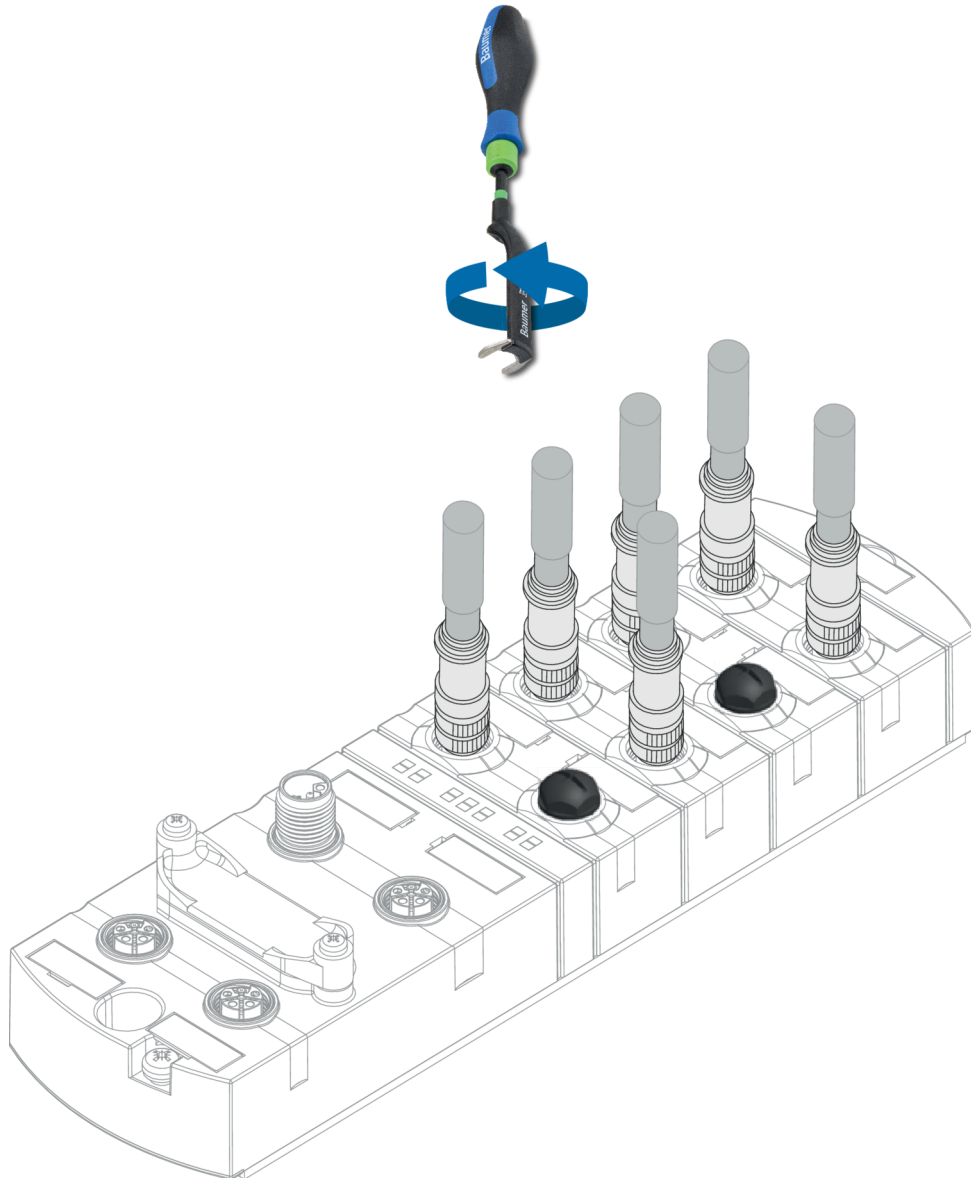
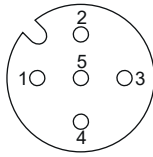

III. 15: Example of M12 connection inputs and outputs

M12	0.6 Nm		Art.-No. 7000-99102-000000
-----	--------	--	-------------------------------

**INFO**

Feeding external ground via M12 female connectors may lead to errors.

- a) Do not feed external ground into the device via the M12 female connectors.

**INFO**

Maximum length of sensor and actuator cables is limited to 30 m.

Sensor supply**Important:**

- Sensors supply is via **pin 1** (24 V) and **pin 3** (0 V) of the M12 female connectors.
- The maximum permissible current for supplying the sensors is **2 A** per M12 socket.
- In the event of overcurrent or short circuit, **disconnect** supply cable resp. sensor from the M12 female connector.

Supported IO-Link communication

The device supports IO-Link communication at the following rates:

- 4.800 Baud (COM 1)
- 38.400 Baud (COM 2)
- 230.400 Baud (COM 3)

**INFO**

The device would automatically select the communication rate appropriate for the related IO-Link device.

**INFO**

Maximum cable length for IO-Link communication is 20 m.

**INFO**

A large selection of connection cables can be found on the Baumer website <https://www.baumer.com>.

7.1.3 PROFINET IO Communication

Connection of M12 female connector

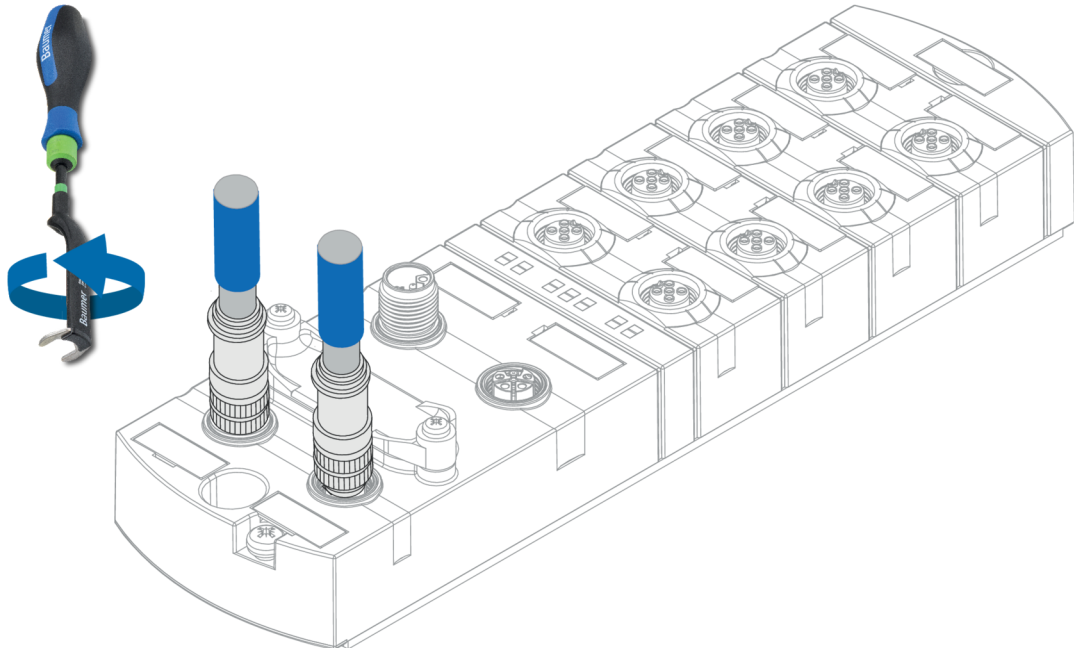
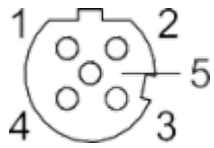

III. 16: Example of M12 connection (EtherNet/IP Bus)

M12	0.6 Nm		Art.-No. 7000-99102-000000
-----	--------	--	-------------------------------

Also see about this

 [Pin assignment \[▶ 10\]](#)

7.1.4 Power supply

According to *PROFINET Cabling and Interconnection Technologys [4] Guideline Version 4.00 May 2017*, a cable with a black outer sheath and 4 strands with the following colors must be used for an M12 L-coded style 4 (4 pin without FE):



III. 17: [4]: Excerpt from "PROFINET Cabling and Interconnection Technology"

A fifth strand which is not connected in the device can increase the interference on the 24 V conductor in the event of EMC interference due to capacitive coupling.

Connection with M12

POWER IN

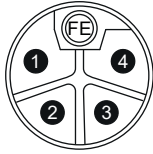

POWER OUT

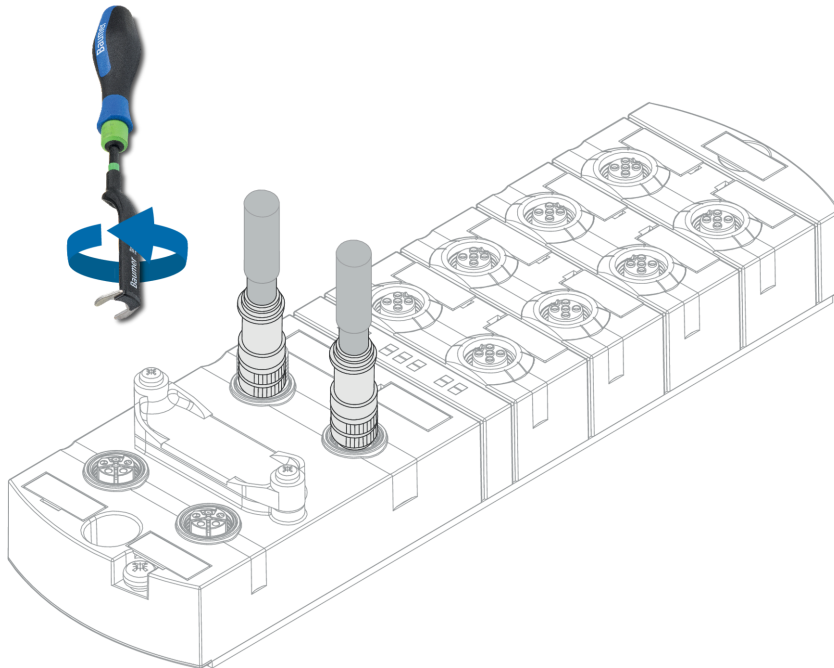
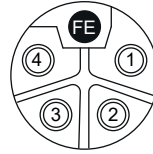

III. 18: Example of M12 connection (POWER)

M12	0.6 Nm		Art.-No. 7000-99102-000000
-----	--------	--	-------------------------------



INFO

A large selection of connection cables can be found on the Baumer website <https://www.baumer.com>.

7.2 Ensuring Tightness (IP67)

⚠ CAUTION

Leaky housing.

Risk of personal injury and material damage due to failure caused by ingress of conductive liquids.

- a) Seal any male and female connectors not in use.

Cable connection



III. 19:

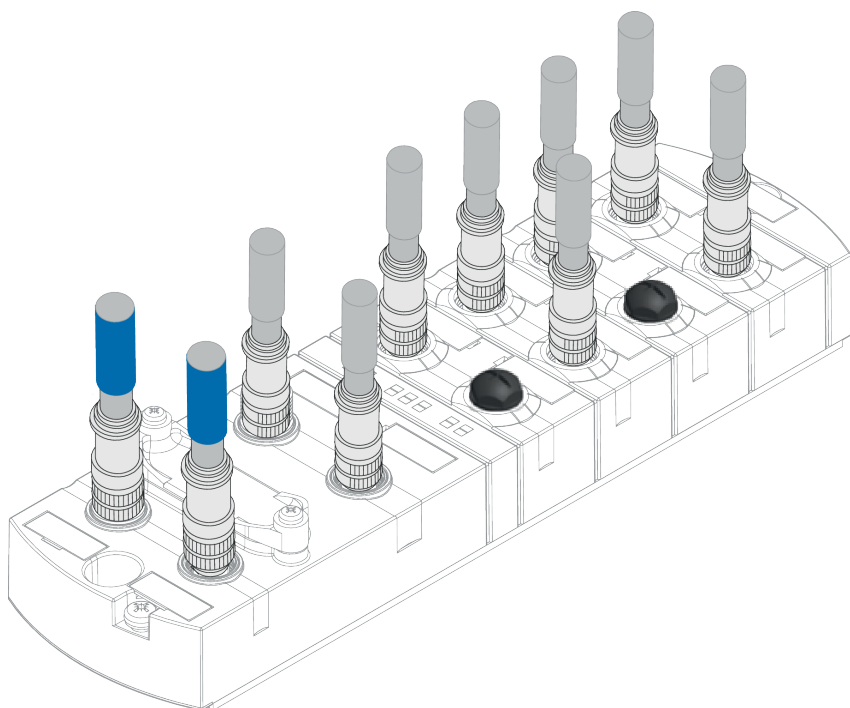

III. 20: Cable connection

M12	0,6 Nm		Art.-No. 7000-99102-000000
-----	--------	--	-------------------------------



INFO

A large selection of connection cables can be found on the Baumer website <https://www.baumer.com>.

8 Commissioning

WARNING

Risk of burns.

Prohibited to separate or establish electrical connection during operation. Failure to observe this warning may result in electric arcs that can cause burns.

- a) Disconnect device from power supply.

CAUTION

Uncontrolled processes.

Personal injury and material damage due to incorrect commissioning (initial commissioning, device restart or change in device configuration).

- a) Commissioning should always observe the order below:
 - a) Insert the device.
 - b) System check and approval by an expert.
 - c) Put into operation.

CAUTION

Functional errors in residential areas.

Devices of EMC Class A may cause interference in residential areas.

- a) The system operator must take appropriate measures.

8.1 Loading GSDML Files

GSDML Files"

Install GSDML file respectively description file

The GSDML file import procedure is described in your engineering software manual. In the engineering software, this is referred to as *Install GSDML files* or *Install device description file*.



INFO

The GSDML file is stored on the Baumer website <https://www.baumer.com> under the article number of the device in the download area.

Hardware catalog

- Read the GSDML file of the *CM50I.PN* into the hardware catalog of the hardware configuration program.

When using **TIA**, the module can then be found in the hardware catalog in the directory structure:

Other field devices | PROFINET IO | I/O | Baumer | CM50I.PN | V1.0

If the engineering software supports structuring in folders, the module is displayed in a similar way to the *hardware catalog* illustration.

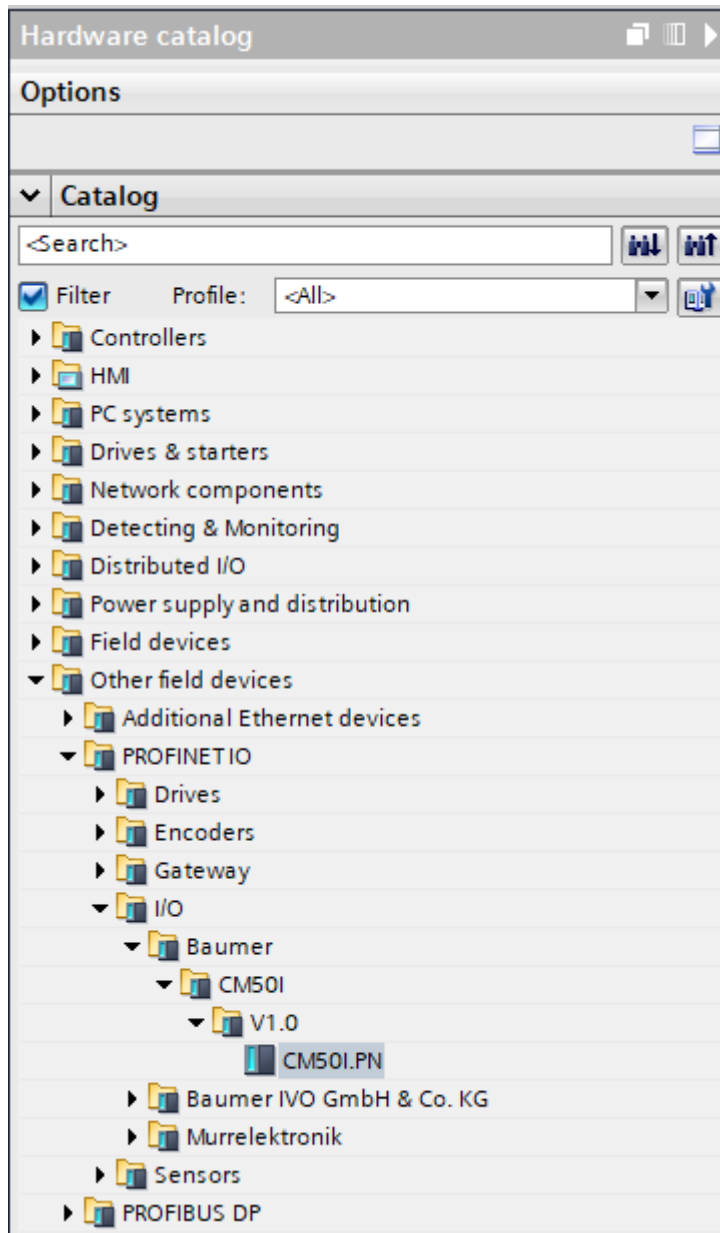

III. 21: Hardware catalog

- a) Select the module *CM50I.PN* in the hardware catalog.
- b) Drag & drop the entry to a free space in **Devices & networks**.

Assign module to new IO controller

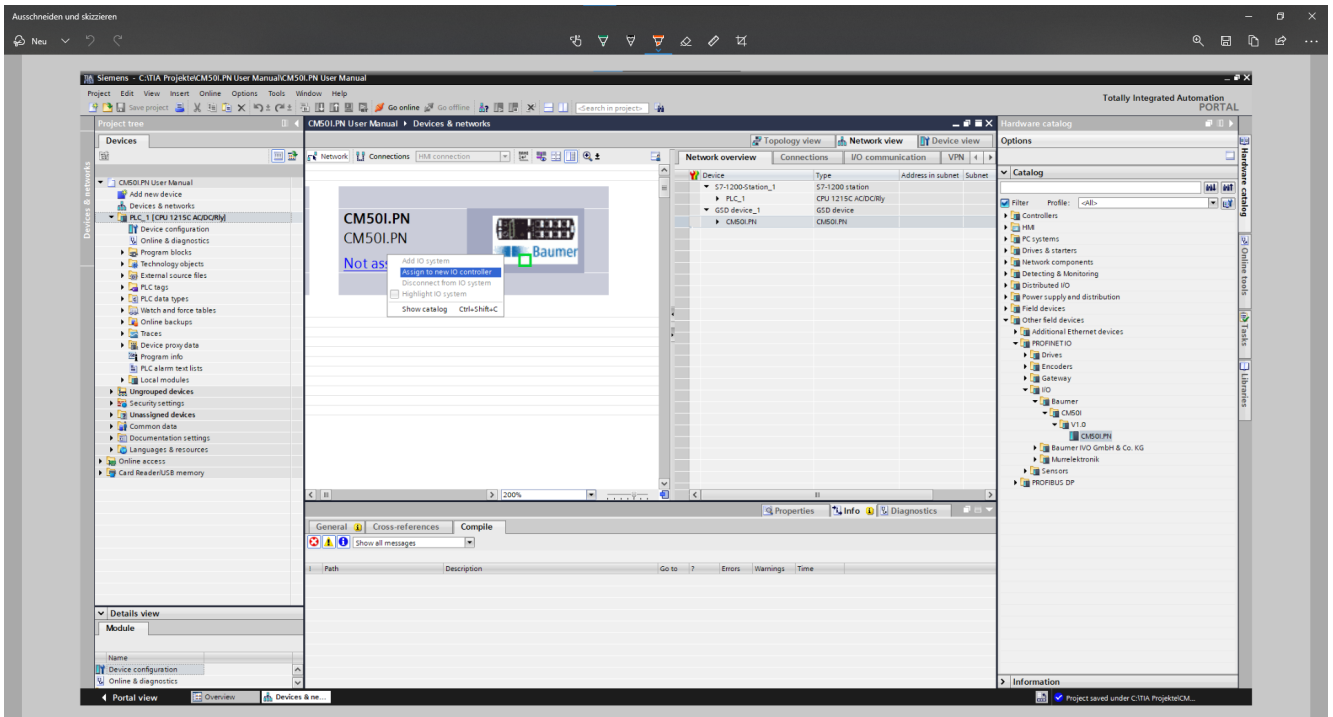

III. 22: Assign module to new IO controller

- On the module icon, click **not assigned**.
- Select **PLC_1.PROFINET-Schnittstelle_1**.
 - ✓ Module is assigned an IO controller.
- Double-click on module for further configuration.

9 Configuration/setting

Overview

There are two options for device configuration.

- First: GSDML file is available for download at the Baumer Website.
 - As described in chapter *Read GSDML files* they can be imported into the programming software to benefit from pre-configured connections.
- Second: Device configuration via the integrated web server.



INFO

To adopt index changes made via Webserver and via acyclic ISDU into DataStorage, a *Param-DownloadStore Command* must be transmitted after the index change.

- a) The *ParamDownloadStore Command* can be triggered by writing value 0x05 to index 0x02.

9.1 Changing the Configuration

⚠ WARNING

Device protection function impaired by changed device configuration.

- a) Only authorized persons may change configuration.
- b) When changing the configuration, use the password hierarchy provided by your engineering software.
- c) After every change in configuration, check proper activity of the safety equipment.

9.2 Module configuration

Individual IO-Link ports *and* virtual modules can be implemented and configured via the hardware catalog.

Standard Module	
MVK Pro device	<ul style="list-style-type: none"> ■ Module parameterization ■ Read and write access to the digital IOs ■ Read and write access to IO-Link devices/ports
MVK Pro options	<ul style="list-style-type: none"> ■ Access to system state and qualifier ■ Communication protocol parameterization ■ Output forcing and web server access

Tab. 3: Module_Configuration_Standard_Modules

9.2.1 Slots

The 8 hardware ports are configured and parameterized via slots 1.X0 to 1.X7. For more port-specific parameter settings please see module “SIO data/Module parameters” on slot 1.1.

The module has the following display in the TIA Portal device view:

- **Slot 1:** PROFINET user
 - with pre-configured “SIO data/Module parameter” slot for universal IO channels and parameter settings
 - with 8 IO-Link ports
- **Slot 2:** Optional module*
 - with 8 optional submodules for design and parameterization of
 - a) optional communication protocols
 - b) the qualifier
 - c) system status
 - d) output forcing
 - e) web server

Module	Rack	Slot	I address	Q address	Type	Articl...
CM501.PN	0	0			CM501.PN	1126...
CM501.PN	0	0 1			CM501.PN	
CM501.PN device_1	0	1	2...3	2...3	CM501.PN device	
SIO data / Module param...	0	1 1	2...3	2...3	SIO data / Module p...	
	0	1 X0 (IO-Link master port 1)				
	0	1 X1 (IO-Link master port 2)				
	0	1 X2 (IO-Link master port 3)				
	0	1 X3 (IO-Link master port 4)				
	0	1 X4 (IO-Link master port 5)				
	0	1 X5 (IO-Link master port 6)				
	0	1 X6 (IO-Link master port 7)				
	0	1 X7 (IO-Link master port 8)				
CM501.PN options_1	0	2			CM501.PN options	
	0	2 1				
	0	2 2				
	0	2 3				
	0	2 4				
	0	2 5				
	0	2 6				
	0	2 7				
	0	2 8				

III. 23: Slots for module configuration

As an option, the saved slots can be assigned specific virtual submodules.

Virtual modules are used to map the various diagnostic and status information to the process image of the IO-Link master.

Sub module to slot assignment is defined by GSDML file.



INFO

**At least one module, however, must be configured.

9.2.2 Modul MVK Pro device

Module *MVK Pro Device* is firmly assigned to slot 1.

Submodules

Name	Slot	Description
SIO data/Module parameters	1.1	<ul style="list-style-type: none"> ▪ Module parameterization ▪ Port parameterization ▪ 2 Byte In Digital input data of the ports ▪ 2 Bytes Out – digital output data of the ports
IO-Link Port X0	1.X0 (IO-Link master port 1)	IO-Link slot. Select a submodule from the hardware catalog.
IO-Link Port X1	1.X1 (IO-Link master port 2)	
IO-Link Port X2	1.X2 (IO-Link master port 3)	
IO-Link Port X3	1.X3 (IO-Link master port 4)	
IO-Link Port X4	1.X4 (IO-Link master port 5)	
IO-Link Port X5	1.X5 (IO-Link master port 6)	
IO-Link Port X6	1.X6 (IO-Link master port 7)	
IO-Link Port X7	1.X7 (IO-Link master port 8)	

Tab. 4: Submodule for MVK Pro Device

9.2.2.1 IO-Link-Ports

The module provides 8 IO-Link ports on slots 1 (X0 to X7), which can be assigned specific IO-Link devices or set to SIO mode.

- Read and write access to the IO-Link devices/ports.

Submodules

Disabled	1 Byte In <ul style="list-style-type: none"> ▪ The corresponding IO-Link port is disabled, i.e. the channel is neither used as digital input or output, nor as IO-Link port. ▪ Input byte is reserved.
Standard digital input	0 Byte In, 0 Byte Out <ul style="list-style-type: none"> ▪ IO-Link standard IO mode ▪ The data is provided at slot 1.1 “SIO data”. ▪ Output is addressed via slot 1.1 “SIO Data/ Module parameters”.
Standard digital output	0 Byte In, 0 Byte Out <ul style="list-style-type: none"> ▪ IO-Link standard IO mode ▪ Output is addressed via slot 1.1 “SIO Data”. ▪ The input is addressed via slot 1.1 “SIO Data/Module parameters”.

IO-Link In x bytes + PQI	<p>x Byte In</p> <ul style="list-style-type: none"> ■ IO-Link device with PQI and x byte(s) of input data. ■ Input data come in the following order: <ul style="list-style-type: none"> ▪ PQI-Daten (1 Byte)** ▪ one padding byte if required* ■ Optional parameterization of diagnostic and IO link properties.
IO-Link Out x bytes + PQI	<p>y Byte Out</p> <ul style="list-style-type: none"> ■ IO-Link device with PQI and y byte(s) of output data. ■ Input data: <ul style="list-style-type: none"> ▪ PQI-Daten (1 Byte) ▪ one padding byte if required* ■ Optional parameterization of diagnostic and IO link properties.
IO-Link In/Out x/y byte + PQI	<p>x Byte In, y Byte Out</p> <ul style="list-style-type: none"> ■ IO-Link device with x byte(s) of input data and y byte(s) of output data. ■ Input data come in the following order: <ul style="list-style-type: none"> ▪ current input data of IO-Link device ▪ PQI Daten (1 Byte) ▪ one padding byte if required* ■ Optional parameterization of diagnostic and IO link properties.
Profile Devices (diverse)	<p>Number of input and output bytes is module-specific.</p> <ul style="list-style-type: none"> ■ Input data come in the following order: <ul style="list-style-type: none"> ▪ current input data of IO-Link device (if present) ▪ PQI Daten (1 Byte) ▪ one padding byte if required* ■ Output data come in the following order: <ul style="list-style-type: none"> ▪ current output data of the IO-Link device (if present) ▪ one padding byte if required ▪ Optional parameterization of diagnostic and IO link properties.
ME devices (various)	<p>Number of input and output bytes is module-specific.</p> <ul style="list-style-type: none"> ■ Input data come in the following order: <ul style="list-style-type: none"> ▪ current input data of IO-Link device (if present) ▪ PQI Daten (1 Byte) ▪ one padding byte if required* ■ Output data come in the following order: <ul style="list-style-type: none"> ▪ current output data of the IO-Link device (if present) ▪ one padding byte if required ▪ Optional parameterization of diagnostic and IO link properties. ▪ Optional device parameterization by module-specific parameters (if present).

Tab. 5: Submodules for IO-Link ports

* **Padding byte:** Reserved byte to achieve even data length.

** **PQI**

The **Port Qualifier Information** (PQI) provides status information on IO-Link port and/ or device.

The flags "PQ"..and DevErr and DevCom" are copied directly from the Arg- Block of the SMI service "SMI_PDIn".

The flags in bit 2 to 4 are generated within the master application layer.

PQI-Flag-Bit Layout

Bit7	Bit6	Bit5	Bit4	Bit3	Bit2	Bit1	Bit0
Device process data validity	Port / device error	Device communication	Port operation	Replacement device identified	New parameter	Reserved ("0")	Reserved ("0")
PQ	DevErr	DevCom	PortActive	SubstDev	New-Par	–	–

Tab. 6: PQI-Flag-Bit Layout

Description of table "Layout of the PQI flag bits"

Flag	M/O	Value	Description
NewPar	M	0	No update of the device parameters identified.
		1	Device parameter update identified: Master has performed a data memory upload and a new IOLD-backup object (0xB901) is available.
SubstDev	M	0	No replacement device identified (identical serial number)..
		1	Replacement device identified (different serial number).
PortActive	M	0	Port disabled via port function.
		1	Port enabled (standard).
DevCom	M	0	No device available.
		1	Device identified and in status pre-operate or operate.
DevErr	M	0	No error/warning occurred.
		1	Error/warning assigned to device or port has occurred.
PQ	M	0	Invalid IO device process data.
		1	Valid IO device process data.

Byte assignment of the generic IO-Link In/Out xx/yy

Bytes	Submodule type																
	DEAC	SIO	Input data submodule							Output data submodule							
			00/yy	01/yy	02/yy	04/yy	08/yy	16/yy	32/yy	xx/00	xx/01	xx/02	xx/04	xx/08	xx/16	xx/32	
0	R		PQI	I	I	I	I	I	I			O	O	O	O	O	O
1				PQI	I	I	I	I	I			R	O	O	O	O	O
2					PQI	I	I	I	I					O	O	O	O
3					R	I	I	I	I					O	O	O	O
4						PQI	I	I	I					O	O	O	O
5						R	I	I	I					O	O	O	O
6							I	I	I					O	O	O	O
7							I	I	I					O	O	O	O

Byte s	Submodule type																
	DEA C	SIO	Input data submodule							Output data submodule							
			00/ yy	01/ yy	02/ yy	04/ yy	08/ yy	16/ yy	32/ yy	xx/ 00	xx/ 01	xx/ 02	xx/ 04	xx/ 08	xx/ 16	xx/ 32	
8								PQI	I	I						O	O
9								R	I	I						O	O
10									I	I						O	O
11									I	I						O	O
12									I	I						O	O
13									I	I						O	O
14									I	I						O	O
15									I	I						O	O
16									PQI	I							O
17									R	I							O
18										I							O
19										I							O
20										I							O
21										I							O
22										I							O
23										I							O
24										I							O
25										I							O
26										I							O
27										I							O
28										I							O
29										I							O
30										I							O
31										I							O
32										PQI							
33										R							

Legend:

- I = Input
- O = Output
- P = PQI (Port Qualifier Information)
- R = Reserved (Padding Byte)
- DEAC = Deaktiviert
- SIO Mode

9.2.3

Modul MVK Pro options

- is firmly assigned to **slot 2**
- All submodules are optional

- However, at least one module must be seated.

Submodules

Name	Slot	Description
Qualifier DI	2.1	2 Byte In <ul style="list-style-type: none"> ▪ Status of individual bits of the inputs in "Digital IO" <ul style="list-style-type: none"> ▪ 0 = invalid ▪ 1: valid ▪ Layout according to parameterization
Qualifier DO	2.2	2 Byte In <ul style="list-style-type: none"> ▪ Status of individual bits of the outputs in "Digital IO" <ul style="list-style-type: none"> ▪ 0 = invalid ▪ 1: valid ▪ Layout according to parameterization
System status *	2.3	4 Byte In <ul style="list-style-type: none"> ▪ Summary of the current system state.
MQTT	2.4	Option to enable MQTT
OPC UA	2.5	Option to enable OPC UA
JSON	2.6	Option to enable JSON
Web server	2.7	Option to enable web server
Output forcing	2.8	Option to enable output forcings
MQTT	2.4	Option to enable MQTT

Tab. 7: Submodules for MVK Pro options



INFO

* For further information on the system status refer to chapter* 8.2.3.1 "Digitale I/O and System Status"

9.2.3.1 Digital I/O and System Status

System status IO layout in decimal and hexadecimal format

Bit	Value in decimal (dec) format	Value in hexadecimal (hex) format	Description
0	1	0x00 00 00 01	Sensor undervoltage
1	2	0x00 00 00 02	Actuator undervoltage
2	4	0x00 00 00 04	No actuator supply
3	8	0x00 00 00 08	Reserved
4	16	0x00 00 00 10	Sensor short circuit on at least one channel.
5	32	0x00 00 00 20	Actuator short circuit on at least one channel.
6	64	0x00 00 00 40	Reserved

Bit	Value in decimal (dec) format	Value in hexadecimal (hex) format	Description
7	128	0x00 00 00 80	Reserved
8	256	0x00 00 01 00	Reserved
9	512	0x00 00 02 00	IO-Link error, e.g. validation or data storage failed.
10	1024	0x00 00 04 00	Sensor overvoltage
11	2048	0x00 00 08 00	Actuator overvoltage
12	4096	0x00 00 10 00	Reserved
13 - 31			Reserved

Tab. 8: System status IO-Layout

Bit assignment of system status binary IO layout

Byte 3

7	6	5	4	3	2	1	0
							Sensor undervoltage
							Actuator undervoltage
							No actuator supply
							Reserved
							Sensor short circuit on at least one channel
							Actuator short circuit on at least one channel
							Reserved
							Reserved

Byte 2

7	6	5	4	3	2	1	0
							Reserved
							IO-Link error, e.g. validation or data storage failed
							Sensor overvoltage
							Actuator overvoltage
							Reserved
							Reserved
							Reserved
							Reserved

Byte 0 and byte 1 system status reserved

9.2.4

Addresses

Once the module has been assigned to the IO-Controller, the I/O addresses are assigned to the project according to the allocated addresses.

I/O addresses manually may also be changed manually.

The screenshot displays the 'Device overview' table with the following data:

Module	Rack	Slot	I address	Q address	Type	Ar...
CM501.PN	0	0			CM501.PN	1...
CM501.PN	0	0 1			CM501.PN	
CM501.PN device_1	0	1			CM501.PN device	
SIO data / Module param...	0	1 1	2...3	2...3	SIO data / Module p...	
Standard digital input	0	1 X0 (IO-Link master port 1)			Standard digital inp...	
Standard digital output	0	1 X1 (IO-Link master port 2)			Standard digital ou...	
Deactivated	0	1 X2 (IO-Link master port 3)	4		Deactivated	
IO-Link In 02 bytes + PQI	0	1 X3 (IO-Link master port 4)	5...8		IO-Link In 02 bytes ...	
IO-Link Out 01 byte + PQI	0	1 X4 (IO-Link master port 5)	9...10	4...5	IO-Link Out 01 byt...	
IO-Link In/Out 02/02 byt...	0	1 X5 (IO-Link master port 6)	11...14	6...7	IO-Link In/Out 02/0...	
IO-Link In/Out 08/02 byt...	0	1 X6 (IO-Link master port 7)	15...24	8...9	IO-Link In/Out 08/0...	
IO-Link In/Out 08/02 byt...	0	1 X7 (IO-Link master port 8)	25...34	10...11	IO-Link In/Out 08/0...	
CM501.PN options_1	0	2			CM501.PN options	
	0	2 1				
	0	2 2				
	0	2 3				
	0	2 4				
	0	2 5				
	0	2 6				
	0	2 7				
	0	2 8				

The 'SIO data / Module parameters' window shows the following configuration:

I/O addresses

Input addresses

Start address: 2
End address: 3
Organization block: --- (Automatic update)
Process image: Automatische Aktualisierung

Output addresses

Start address: 2
End address: 3
Organization block: --- (Automatic update)
Process image: Automatische Aktualisierung

III. 24: Module configuration addresses

9.3 Module parameterization



INFO

The present chapter explains the parameterization options.

The following modules are described:

- MVK Pro device
- MVK Pro options

9.3.1 Modul MVK Pro device

Submodule overview

- SIO data/Module parameters
- Disabled
- Standard digital input
- Standard digital output

- Generic IO-Link modules
- Profile Devices
- ME devices

Submodule module parameters

No.	Sub-module	Parameter-No.	Parameter
1	SIO data/Module parameters	1	Pin/port-based
		2	Disable global diagnostics report
		3	Disable undervoltage bus/sensor supply report
		4	Threshold value undervoltage bus/sensor supply
		5	Disable undervoltage actuator supply report
		6	Enable threshold actuator undervoltage
		7	Disable missing actuator supply report
		8	Enable LED indication for suppressed diagnostics
		9	Enable IO-Link diagnostics report
		10	US disabled at pin 1
		11	SIO Channel functionality pin 2
		12	Input delay pin 2
		13	Rated current for pin 1
		14	Rated current for pin 2
		15	Rated current for pin 4
		16	IO-Link diagnostic event integration
		17	Manual restart pin 2 in the event of overcurrent
		18	Input value in the event of module failure
2	Disabled	19	Port mode
		20	Input value in the event of module failure
3	Standard digital input	21	Function pin 4
		22	Input delay pin 4
		23	Enable port diagnostics report
4	Standard digital output	24	Static output signal at pin 4
		25	Manual restart pin 4 in the event of overcurrent
		26	Enable port diagnostics report
5	Generic	27	Enable port diagnostics report
6	IO-Link modules	28	Enable process alarms report
7	Profile Devices, ME devices	29	Configuration via PDCT
		30	Input data fraction
		31	Enable pull/plug diagnostics report
		32	Port mode
		33	Validation/backup

No.	Sub-module	Parameter-No.	Parameter
		34	Cycle time
		35	Vendor ID
		36	Device ID

Tab. 9: Overview on submodule parameters 1 ... 36

9.3.1.1 Submodul 1_SIO data/Module parameters

Parameter 1

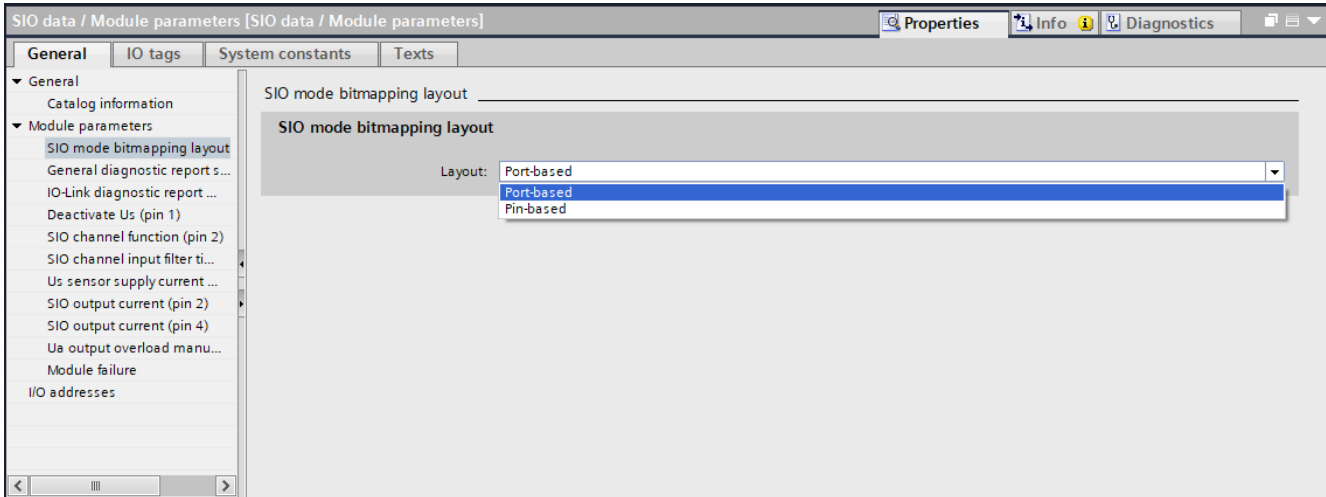

III. 25: Parameter No. 1_pin/port based

No.	Parameter	Selection (D-Default)	Description
1	Layout	Port-based (D)	Transmission of IO data in port-based format.
		Pin-based	Transmission of IO data in port-based format.

Port-based I/O data / Qualifier, DI/DO

I/O Byte 0							
Bit 0	Bit 1	Bit 2	Bit 3	Bit 4	Bit 5	Bit 6	Bit 7
Port X0 Pin 4	Port X0 Pin 2	Port X1 Pin 4	Port X1 Pin 2	Port X2 Pin 4	Port X2 Pin 2	Port X3 Pin 4	Port X3 Pin 2
I/O Byte 1							
Bit 0	Bit 1	Bit 2	Bit 3	Bit 4	Bit 5	Bit 6	Bit 7
Port X4 Pin 4	Port X4 Pin 2	Port X5 Pin 4	Port X5 Pin 2	Port X6 Pin 4	Port X6 Pin 2	Port X7 Pin 4	Port X7 Pin 2

Tab. 10: Port-based data layout

Pin-based I/O data / Qualifier, DI/DO

I/O Byte 0							
Bit 0	Bit 1	Bit 2	Bit 3	Bit 4	Bit 5	Bit 6	Bit 7

Port X0 Pin 4	Port X1 Pin 4	Port X2 Pin 4	Port X3 Pin 4	Port X4 Pin 4	Port X5 Pin 4	Port X6 Pin 4	Port X7 Pin 4
I/O Byte 1							
Bit 0	Bit 1	Bit 2	Bit 3	Bit 4	Bit 5	Bit 6	Bit 7
Port X0 Pin 2	Port X1 Pin 2	Port X2 Pin 2	Port X3 Pin 2	Port X4 Pin 2	Port X5 Pin 2	Port X6 Pin 2	Port X7 Pin 2

Tab. 11: Pin-based data layout

Parameter 2-8

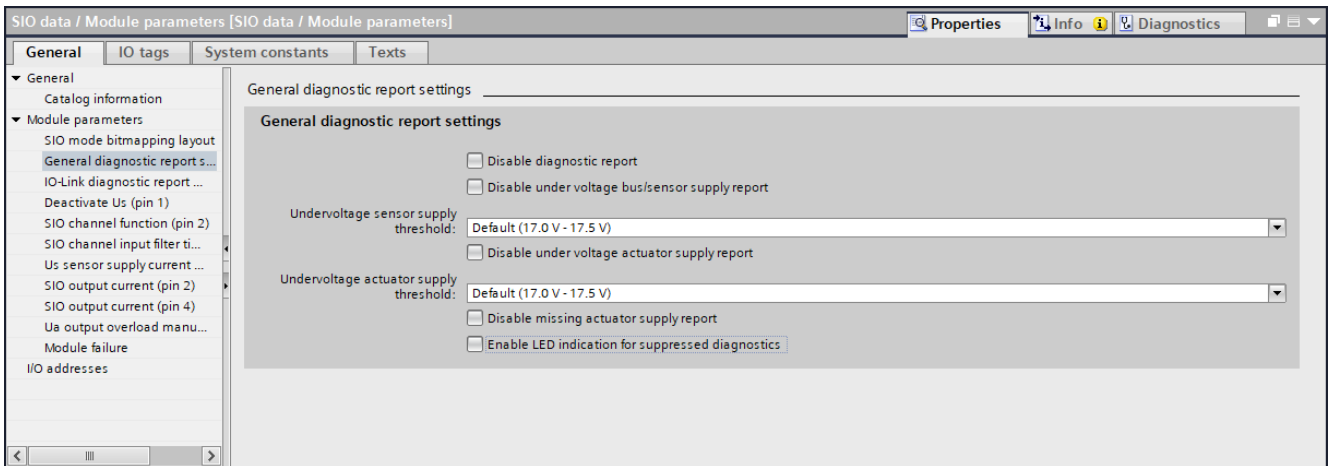

Ill. 26: Parameter no. 2-8 _General diagnostic messages

No.	Parameter	Selection (D-Default)	Description
2	Disable diagnostics report	Off (D)	Enable diagnostic report.
		On	Diagnostic report <i>disabled</i> .
3	Disable undervoltage bus/sensor supply report	Off (D)	Enable reporting undervoltage bus/sensor supply.
		On	Undervoltage bus/sensor supply is <i>disabled</i> .
4	Undervoltage sensor supply threshold	17.0 ... 17.5 V (D)	Reporting is within the selected range.
		17.5 ... 18.0 V (D)	
		18.0 ... 18.5 V (D)	
		18.5 ... 19.0 V (D)	
		19.0 ... 19.5 V (D)	
5	Disable missing actuator supply report	Off (D)	Reporting undervoltage of actuator supply is enabled.
		On	Reporting undervoltage of actuator supply <i>disabled</i> .
6	Undervoltage actuator supply threshold	17.0 ... 17.5 V (D)	Reporting is within the selected range.
		17.5 ... 18.0 V (D)	
		18.0 ... 18.5 V (D)	
		18.5 ... 19.0 V (D)	
		19.0 ... 19.5 V (D)	

No.	Parameter	Selection (D-Default)	Description
		19.5 ... 20.0 V (D)	
7	Disable missing actuator supply report	Off (D)	Reporting undervoltage of actuator supply is enabled.
		On	Reporting undervoltage of actuator supply <i>disabled</i> .
8	Enable LED indication for suppressed diagnostics	Off (D)	Disable LED indication for suppressed diagnostics.
		On	Enable LED indication for suppressed diagnostics.

Parameter 9

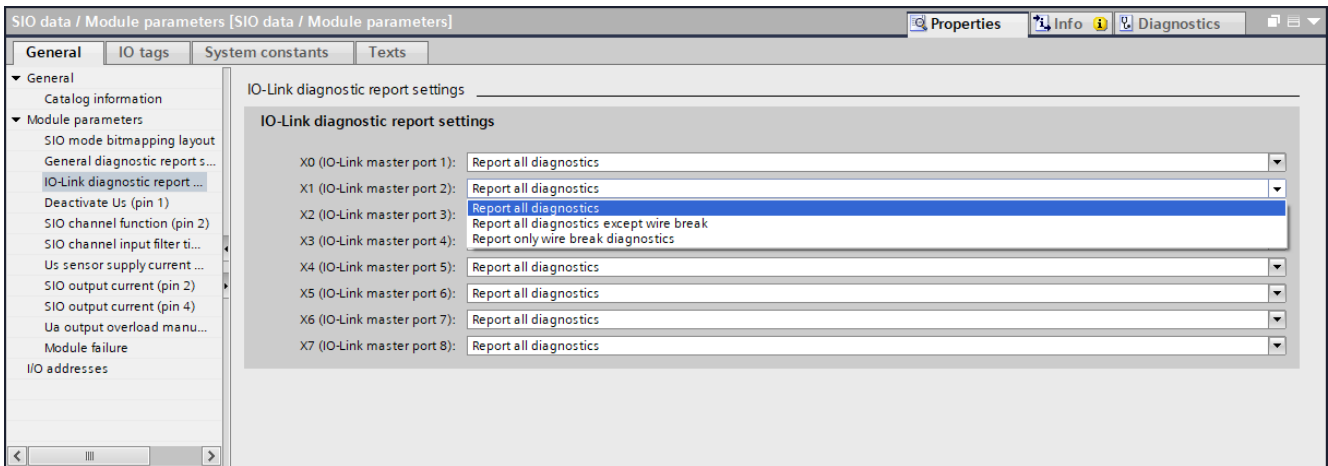

III. 27: Parameter No. 9_IO-Link diagnostics report

No.	Parameter	Selection (D-Default)	Description
9	Enable IO-Link master port report	Report all diagnostics	All diagnostics are displayed
		Report all diagnostics except wire break	No line break diagnostics are displayed.
		Report only wire break diagnostics	Only cable break diagnoses are displayed.

Parameter 10

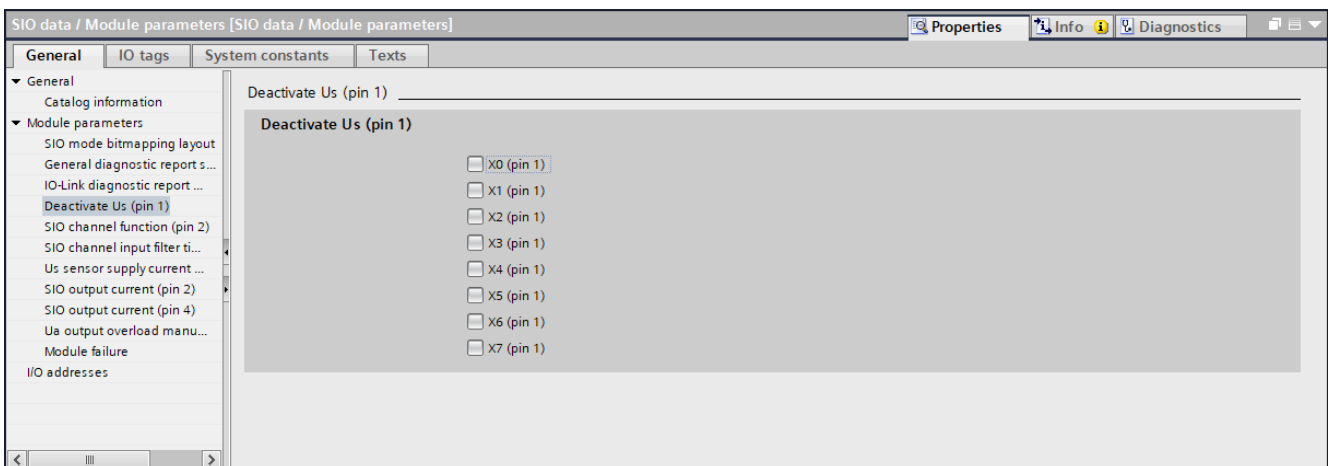

III. 28: Parameter No. 10_disable US at pin 1

No.	Parameter	Selection (D-Default)	Description
10	Deactivate US (pin1)	Off (D)	Pin 1 supplies 24 VDC, e.g. for sensor supply.
		On	No voltage on pin 1!



INFO

Free selection of the individual port settings.

Parameter 11

III. 29: Parameter No. 11_SIO channel function pin 2

No.	Parameter	Selection (D-Default)	Description
11	SIO channel function (pin 2)	Automatic mode (D)	Automatic configuration (automatic input or output recognition).
		Digital input (normally-open NO)	Input normally closed
		Output (CPU STOP =off)	Output
		AUX power	Static voltage +24 V DC for supply of Class B devices.
		Disabled	Disabled

Parameter 12

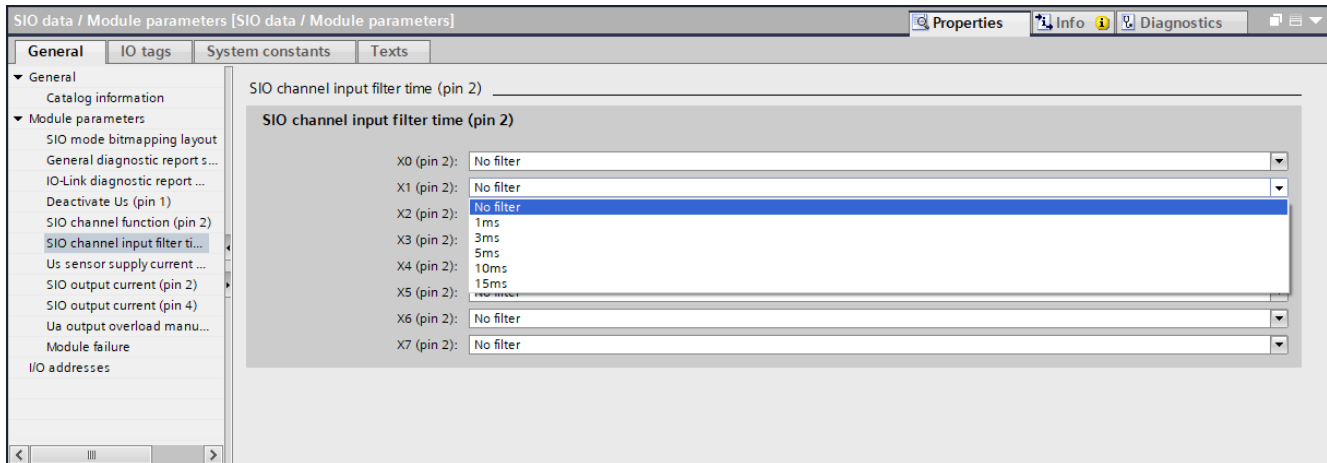

III. 30: Parameter No. 12_Input delay pin 2

No.	Parameter	Selection (D-Default)	Description
12	SIO channel input filter time (pin 2)	No filter (D)	No input delay
		1 ms	Input delay 1 ms
		3 ms	Input delay 3 ms
		5 ms	Input delay 5 ms
		10 ms	Input delay 10 ms
		15 ms	Input delay 15 ms



INFO

The input delay time acts as a filter that detects input signals as high only when time X is active.

Parameter 13

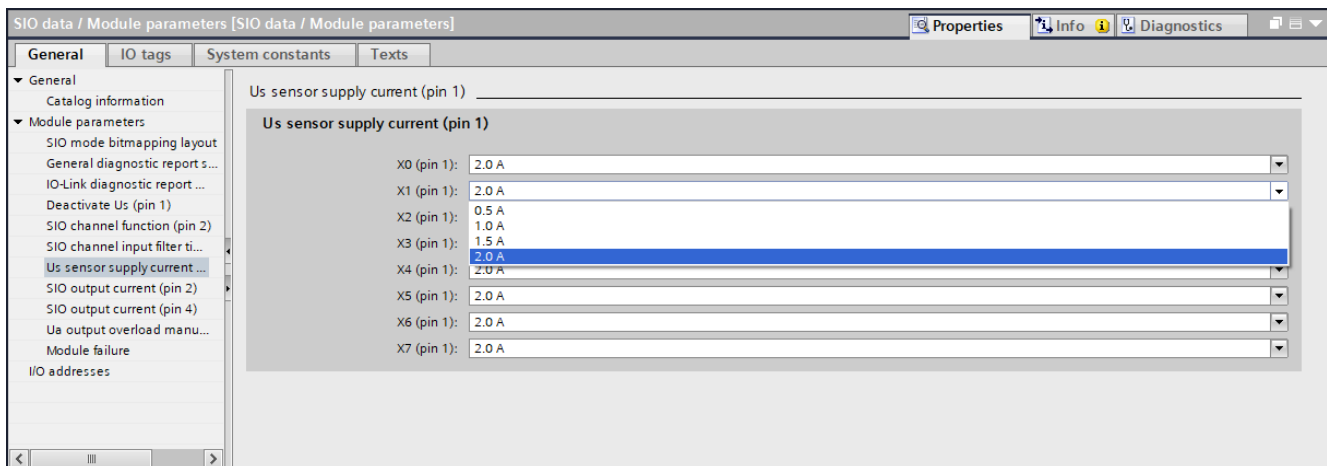

III. 31: Parameter No. 13_Rated current for pin 1

No.	Parameter	Selection (D-Default)	Description
13	Ua sensor supply current (pin 1)	2,0 A (D)	Overload of 125 % will switch off pin.
		1,5 A	
		1 A	
		0,5 A	

Parameter 14

SIO data / Module parameters [SIO data / Module parameters]

General IO tags System constants Texts

General

Module parameters

SIO mode bitmapping layout

General diagnostic report s...

IO-Link diagnostic report ...

Deactivate Us (pin 1)

SIO channel function (pin 2)

SIO channel input filter ti...

Us sensor supply current ...

SIO output current (pin 2)

SIO output current (pin 4)

Ua output overload manu...

Module failure

I/O addresses

SIO output current (pin 2)

X0 (pin 2): 2.0 A

X1 (pin 2): 2.0 A

X2 (pin 2): 0.5 A

X3 (pin 2): 1.5 A

X4 (pin 2): 2.0 A

X5 (pin 2): 2.0 A

X6 (pin 2): 2.0 A

X7 (pin 2): 2.0 A

III. 32: Rated current for pin 2 at the output

No.	Parameter	Selection (D-Default)	Description
14	Rated current for pin 2 at the output (SIO output current pin 4)	2,0 A (D)	Overload of 125 % will switch off pin.
		1,5 A	
		1 A	
		0,5 A	

Parameter 15

SIO data / Module parameters [SIO data / Module parameters]

General IO tags System constants Texts

General

Module parameters

SIO mode bitmapping layout

General diagnostic report s...

IO-Link diagnostic report ...

Deactivate Us (pin 1)

SIO channel function (pin 2)

SIO channel input filter ti...

Us sensor supply current ...

SIO output current (pin 4)

SIO output current (pin 2)

Ua output overload manu...

Module failure

I/O addresses

SIO output current (pin 4)

X0 (pin 4): 2.0 A

X1 (pin 4): 2.0 A

X2 (pin 4): 0.5 A

X3 (pin 4): 1.5 A

X4 (pin 4): 2.0 A

X5 (pin 4): 2.0 A

X6 (pin 4): 2.0 A

X7 (pin 4): 2.0 A

III. 33: Rated current for pin 2 at the output

No.	Parameter	Selection (D-Default)	Description
15	Rated current for pin 4 at the output (SIO output current pin 4)	2,0 A (D)	Overload of 125 % will switch off pin.
		1,5 A	
		1 A	
		0,5 A	

**INFO**

Free parameter selection for ports X0 to X7.

Parameter 17

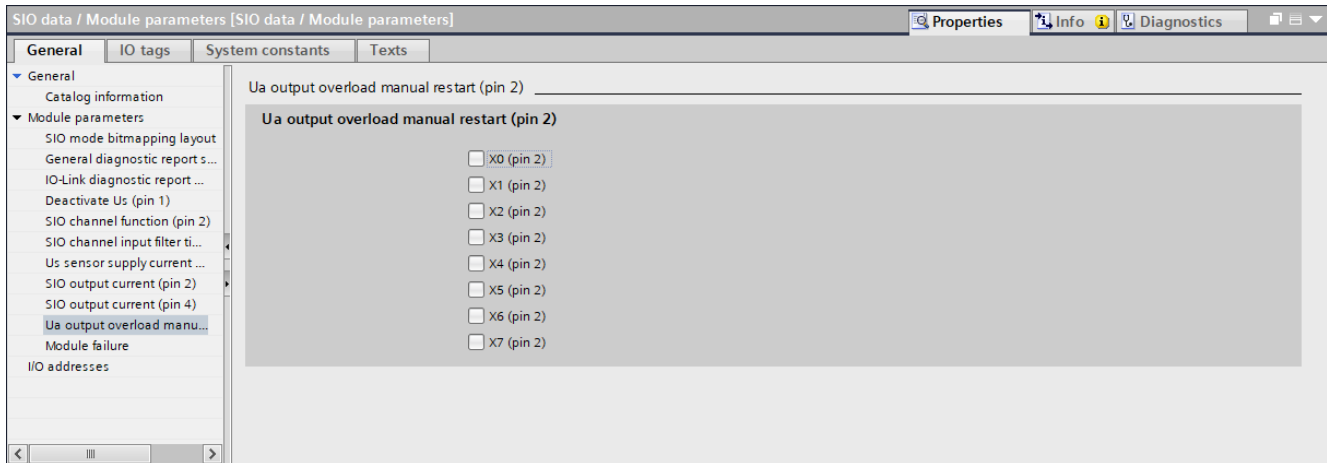

III. 34: Parameter No. 17_Manual restart pin 2 in the event of overcurrent

No.	Parameter	Selection (D-Default)	Description
17	Ua output overload manual restart pin 2	Off (D)	Autotmatic erro reset after approx. 10 seconds if error has not occurred again.
		On	No error reset until the related output signal has been manuallyset to 0. This function is currently not available. For this reason, this parameter is not accessible.

Parameter 18

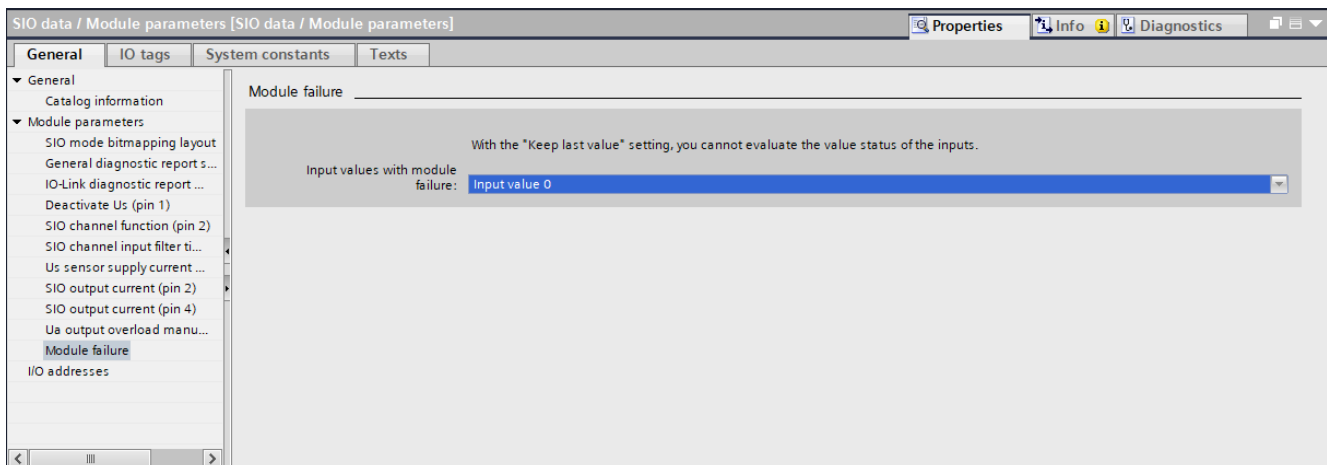

III. 35: Parameter No. 18_Input value in case of module failure

No.	Parameter	Selection (D-Default)	Description
18	Input values with module failure	Input value 0 (D)	The input value is set to 0.
		Keep last value	The last input value remains active.

9.3.1.2 Submodule 2_Disabled

Parameter 19 -20

The screenshot displays the CM501.PN configuration software. The 'Device overview' table is as follows:

Module	Rack	Slot	I address	Q address	Type	Article no.
CM501.PN	0	0			CM501.PN	11261571
CM501.PN	0	0.1			CM501.PN	
CM501.PN device_1	0	1			CM501.PN device	
SIO data / Module param...	0	1.1	2...3	2...3	SIO data / Module p...	
Standard digital input	0	1 X0 (IO-Link master port 1)			Standard digital inp...	
Standard digital output	0	1 X1 (IO-Link master port 2)			Standard digital ou...	
Deactivated	0	1 X2 (IO-Link master port 3)	4		Deactivated	
IO-Link In 02 bytes + PQI	0	1 X3 (IO-Link master port 4)	5...8		IO-Link In 02 bytes ...	
IO-Link Out 01 byte + PQI	0	1 X4 (IO-Link master port 5)	9...10	4...5	IO-Link Out 01 byt...	
IO-Link In/Out 02/02 byt...	0	1 X5 (IO-Link master port 6)	11...14	6...7	IO-Link In/Out 02/0...	
IO-Link In/Out 08/02 byt...	0	1 X6 (IO-Link master port 7)	15...24	8...9	IO-Link In/Out 08/0...	
IO-Link In/Out 08/02 byt...	0	1 X7 (IO-Link master port 8)	25...34	10...11	IO-Link In/Out 08/0...	
CM501.PN options_1	0	2			CM501.PN options	
	0	2.1				
	0	2.2				
	0	2.3				
	0	2.4				
	0	2.5				
	0	2.6				
	0	2.7				
	0	2.8				

The 'Properties' window for the 'Deactivated' port shows the following settings:

- Port Mode: Deactivated
- Input values with module failure: Input value 0

III. 36: Parameter Nor. 19-20_Module Parameters

No.	Parameter	Selection (D-Default)	Description
19	Port mode	Disabled (D)	Parameter cannot be edited!
20	Input values with module failure	Input value 0 (D)	The input value is set to 0.
		Keep last value	The last input value is used and not overwritten with 0.

9.3.1.3 Submodul 3_Standard digital input

Parameter 21 - 23

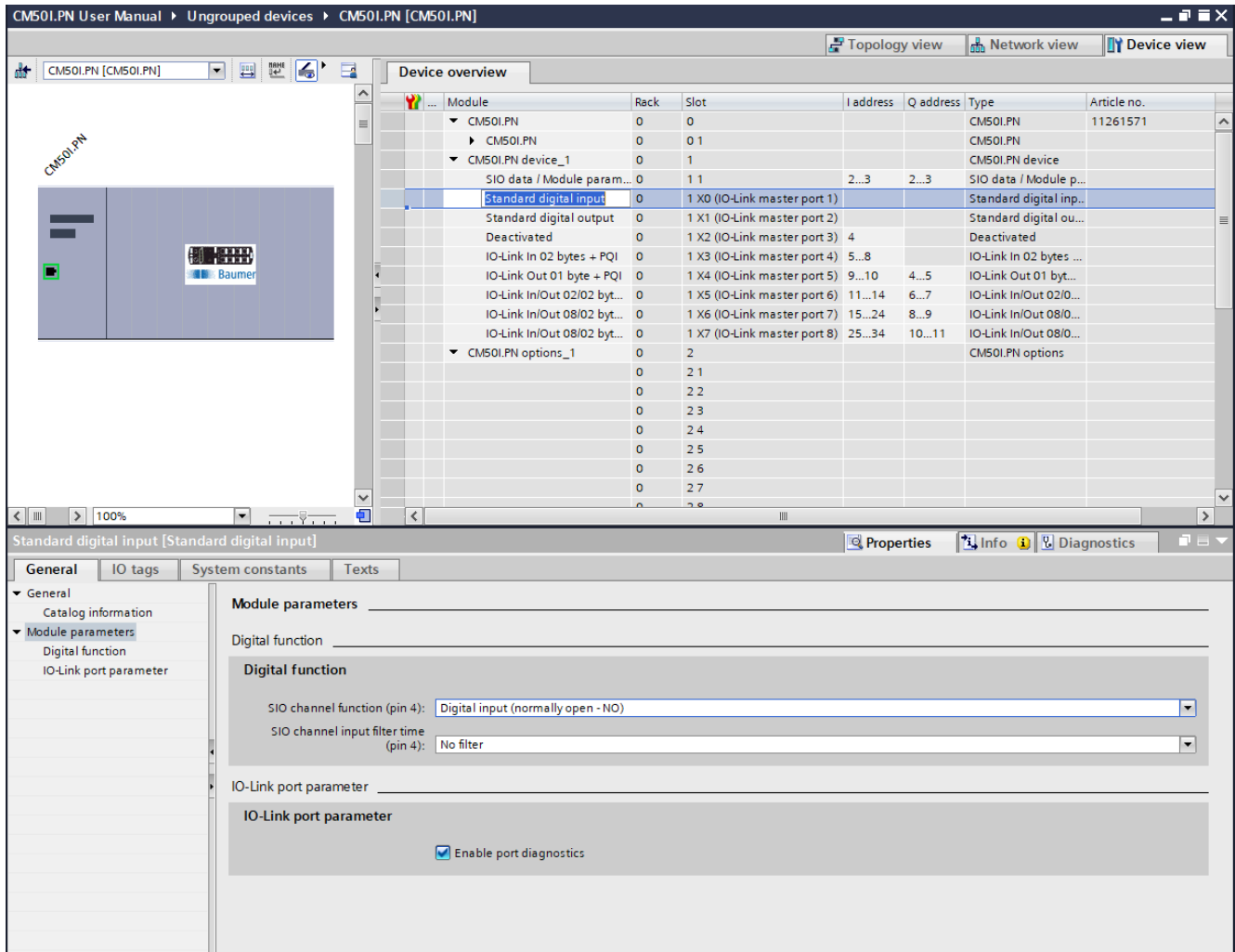

III. 37: Parameter No. 21, 22, 23_Digital input

No.	Parameter	Selection (D-Default)	Description
21	SIO channel function (pin 4)	Digital input (normally open NO) (D) Digital input (normally closed NC)	Normally open or closed
22	SIO channel input filter time (pin 4)	No filter	The input delay time acts as a filter that detects input signals as high only when time X is active.
23	Enable IO-Link port parameter report	Enable port diagnostics An (D)	Reporting of IO-Link device and IO-Link master errors.
		Enable port diagnostics Off	No reporting of IO-Link device and IO-Link master errors.

9.3.1.4 Submodul 4_Standard digital output

Parameter 24 - 26

The screenshot displays the CM501.PN User Manual software interface. The 'Device overview' table lists the following modules and parameters:

Module	Rack	Slot	I address	Q address	Type	Article no.
CM501.PN	0	0			CM501.PN	11261571
CM501.PN	0	0 1			CM501.PN	
CM501.PN device_1	0	1			CM501.PN device	
SIO data / Module param...	0	1 1	2...3	2...3	SIO data / Module p...	
Standard digital input	0	1 X0 (IO-Link master port 1)			Standard digital inp...	
Standard digital output	0	1 X1 (IO-Link master port 2)			Standard digital ou...	
Deactivated	0	1 X2 (IO-Link master port 3)	4		Deactivated	
IO-Link In 02 bytes + PQI	0	1 X3 (IO-Link master port 4)	5...8		IO-Link In 02 bytes ...	
IO-Link Out 01 byte + PQI	0	1 X4 (IO-Link master port 5)	9...10	4...5	IO-Link Out 01 byt...	
IO-Link In/Out 02/02 byt...	0	1 X5 (IO-Link master port 6)	11...14	6...7	IO-Link In/Out 02/0...	
IO-Link In/Out 08/02 byt...	0	1 X6 (IO-Link master port 7)	15...24	8...9	IO-Link In/Out 08/0...	
IO-Link In/Out 08/02 byt...	0	1 X7 (IO-Link master port 8)	25...34	10...11	IO-Link In/Out 08/0...	
CM501.PN options_1	0	2			CM501.PN options	
	0	2 1				
	0	2 2				
	0	2 3				
	0	2 4				
	0	2 5				
	0	2 6				
	0	2 7				
	0	2 8				

The 'Standard digital output' module properties are shown in the 'General' tab. The 'Digital function' section includes the following options:

- Output static = on (pin 4)
- Ua output overload manual restart (pin 4)

The 'IO-Link port parameter' section includes the following option:

- Enable port diagnostics

Ill. 38: Parameter No. 24, 25, 26_Digital output

No.	Parameter	Selection (D-Default)	Description
24	Static output signal at pin 4 (Output static = on (pin 4))	Off (D)	No static output signal os active.
		On	Static output signal is active.
25	Ua output overload manual restart (pin 4)	Off (D)	<i>Automatic</i> error reset after approx. 10 seconds, provided the error has not occurred again.
		On	The error is only logged off after the relevant output signal has been <i>manually</i> set to 0. This function is currently not available. For this reason, this parameter is not accessible.

No.	Parameter	Selection (D-Default)	Description
26	Enable IO-Link port parameter report	Enable port diagnostics On (D)	Reporting of every IO-Link device and IO-Link master error.
		Enable port diagnostics Off	No reporting of IO-Link device and IO-Link master errors.

9.3.1.5 Submodule 5, 6, 7

- Submodule 5 generic IO-Link modules
- Submodule 6 Profile Devices
- Submodule 7 ME devices

Parameter 27 - 36

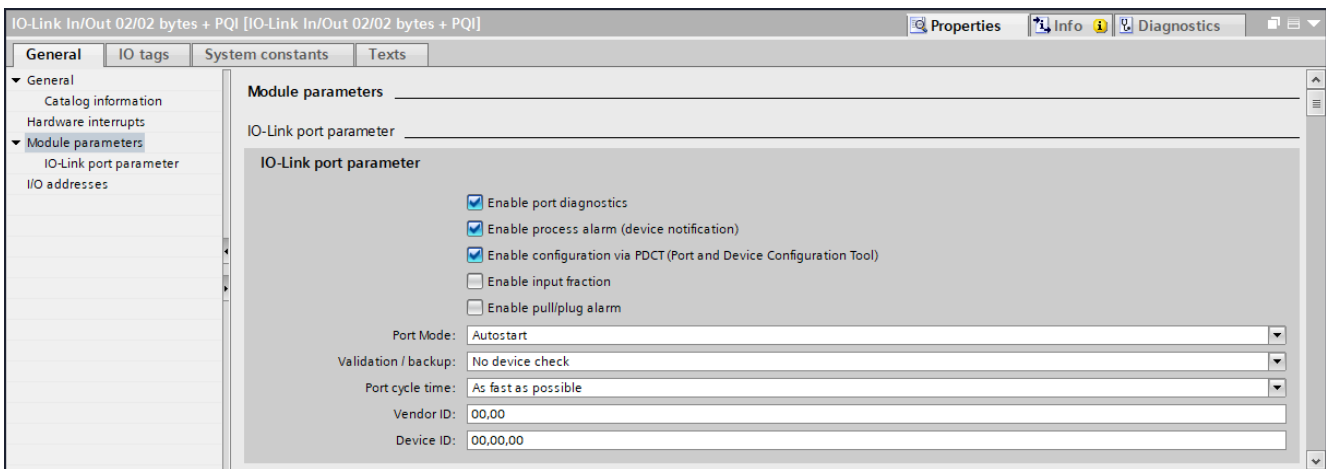

III. 39: Parameter Nr. 27 ... 36

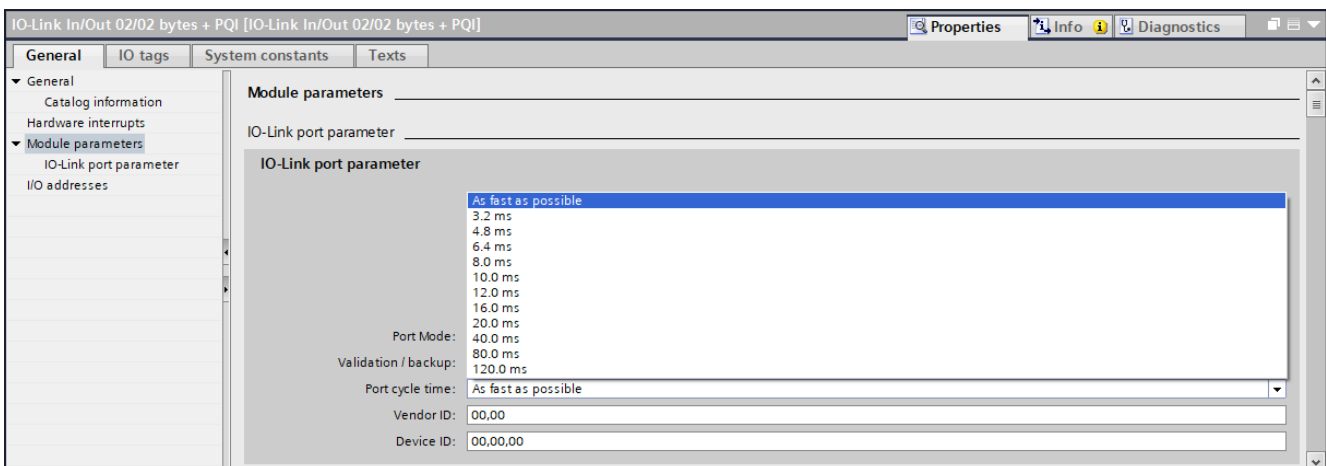

III. 40: Parameter No. 34_Cycle time

No.	Parameter	Selection (D-Default)	Description
27	Enable port diagnostics report	Off	NO reporting of IO-Link port diagnostics.
		On (D)	Reporting of IO-Link port diagnostics.
28	Enable process alarm report (device notification)	Off	No process alarm reporting.
		On (D)	Process alarm reporting enabled.

No.	Parameter	Selection (D-Default)	Description
29	Configuration via PDCT (Enable configuration via PDCT (Port and Device Configuration Tool))	Off	No configuration via PDCT enabled.
		On (D)	Configuration via PDCT enabled.
30	Enable input fraction	Off (D)	Validating input data length of the connected device.
		On	The input data length of the connected device may exceed the configured length. However, no error report. For more informationen see "IO-Link-data length"
31	Enable pull/plug diagnostics report	Off	No pull/plug diagnostics reporting if <ul style="list-style-type: none"> an IO-Link device connection gets lost a device has been identified.
		On (D)	Pull/plug reporting enabled if <ul style="list-style-type: none"> an IO-Link device connection gets lost a device has been identified.
32	Port mode*	Autostart (D)	IO-Link mode. Validity check and filter time setting not enabled.
		Manual	IO-Link mode. Validity check and filter time setting not enabled.
		Disabled	Disabled

No.	Parameter	Selection (D-Default)	Description
33	Validation/backup*	No device check (D)	No validity checks enabled
		Type compatible device (1.0)	Validity check is performed if port mode is set to Manual. Check is performed on IO-Link version 1.0. Output of diagnostics if device is not compatible.
		Type compatible device (1.1)	Validity check is performed if port mode is set to Manual. Check is performed on IO-Link version 1.1. Output of diagnostics if device is not compatible.
		Type compatible V1.1 device with backup + restore	Validity check is performed if port mode is set to Manual. Check is performed on IO-Link version 1.0. Output of diagnostics if device is not compatible. Restore+backup behavior as defined in the IO-Link specification, see "IO-Link_DataStorage. Option Restore"
		Type compatible V1.1 device with restore	Validity check is performed if port mode is set to Manual. Check is performed on IO-Link version 1.0. Diagnostics reporting if device is not compatible. Restore behavior as defined in the IO-Link specification.
34	<input type="checkbox"/> Cycle time (Port cycle time), see "Parameter cycle time"	as fast as possible (D)	The Master and connected IO-Link module will automatically determine the shortest cycle time.
		3.2 ms	Specified filter time
		4.8 ms	Specified filter time
		6.4 ms	Specified filter time
		8.0 ms	Specified filter time
		10 ms	Specified filter time
		12 ms	Specified filter time
		16 ms	Specified filter time
		20 ms	Specified filter time
		40 ms	Specified filter time
		80 ms	Specified filter time
120 ms	Specified filter time		
35	Vendor ID*	00, 00	Vendor ID of the IO-Link device to be used. Will be applied in validity check.

No.	Parameter	Selection (D-Default)	Description
		2-byte list, byte by byte, separated by comma and in hexadecimal format	
36	Device ID*	00, 00, 00 3-byte list, byte by byte, separated by comma and in hexadecimal format	Device ID of the IO-Link device to be used. Will be applied in validity check.

*Submodule 7 ME devices

Check the validity of the connected devices in submodule 7 "ME devices". Therefore the following restrictions apply to the parameter selection:

- **Port mode**
 - Parameter "Port mode" is permanently set to "Manual".
- **Validation/backup**
 - Parameter "Validation/backup" is preset to "Type compatible device (1.1)". Only the options "Type compatible device (1.1)" and "Type compatible device (1.0)" can be selected.
- **Vendor ID**
 - Parameter "Vendor ID" is permanently set to the ID of the described device.
- **Device ID**
 - Parameter "Device ID" is permanently set to the ID of the described device.

IO-Link data length



INFO

Different lengths of IO-Link data are transmitted to Profinet without error.

In this case, however, part of the input data is transferred via Profinet. We expect input data length may vary (4, 6, and 8 bytes) according to sensor parameterization or profile. Sub module configuration in Profinet can define 4 input bytes and enable parameter "enable input fraction". This prevents any mismatch alarm and the first 4 bytes of the sensor are mapped to Profinet. The other bytes will be ignored.

A use case would be the IOL sensor which provides optional additional diagnostic input bytes; these would be ignored in Profinet if they are not PLC/machine. relevant. In this case, data are accessible in another way, e.g. OPC UA, MQTT, JSON.

IO-Link-DataStorage. Option Restore



INFO

When switching to “Restore” status, any previous device configurations stored in the device will be discarded, especially when switching from “Back-up&Restore” to “Restore”.

Upon initial connection of a compatible device in “Restore” status:

- a) Master is retrieving the DataStorage data (one-time backup) from the device,
- b) saves it *and*
- c) will transmit the data to every compatible device which is connected next with different configuration (Restore).

Parameter cycle time

Communication cycle time

Selection (D = Default)	Description
As fast as possible (D)	The master and the IO-Link device automatically determine the fastest cycle time.
3,2 ... 128,0 ms	Set cycle time to this value.

Tab. 12: Communication cycle time

The parameter cycle time defines the cycle time applied in IO-Link Master and IO-Link device r communication.

For most applications, “As fast as possible” is best. When establishing communication, master and device select the shortest possible cycle time.

Specific conditions (e.g. using inductive couplers or other intermediate devices between master and IO-Link device) may require manual setting of cycle time.

If so, select a permanent cycle time (to be supported both by master and device) to remedy the problem.

Further information on the bits used in generic IO-Link devices please refer to section [IO-Link-Ports \[▶ 44\]](#)

9.3.2 Modul MVK Pro options

Submodule overview

- Qualifier DI
- Qualifier DO
- System status
- MQTT
- OPC UA
- JSON
- Web server
- Output Forcing

Submodule module parameters

No.	Sub-module	Parameter-No.	Parameter
1	Qualifier DI	37	Input value in the event of module failure
2	Qualifier DO		
3	Systemstatus		
4	MQTT	38	Activation
		39	Server IP-Adresse
		40	Client ID
		41	Client head topic
		42	Topic for system data
5	OPC UA	43	Activation
		44	TCP port number
		45	Writing of ISDU data
		46	Writing of PDO data
6	JSON	47	Activation
7	Web server	48	Activation
8	Output Forcing	49	Forcing rules

Tab. 13: Overview on submodule parameters 37 ... 49

9.3.2.1

Submodule 1-3

- Submodule Qualifier DI
- Submodule Qualifier DO
- Submodule System Status

Parameter 37

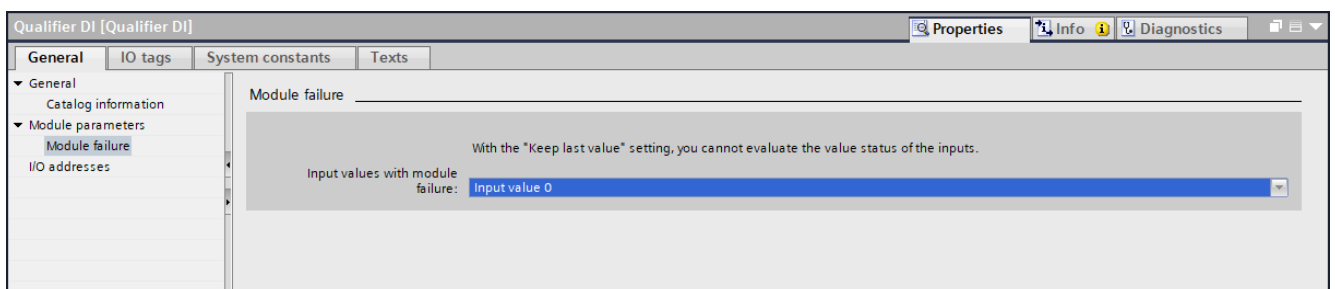

Ill. 41: Parameter no. 37

No.	Parameter	Selection (D-Default)	Description
37	Input values with module failure	Input value 0 (D)	The input value is set to 0.
		Keep last value	The last input value is applied and will not be overwritten by 0.

9.3.2.2 Submodule 4_MQTT

Parameter 38

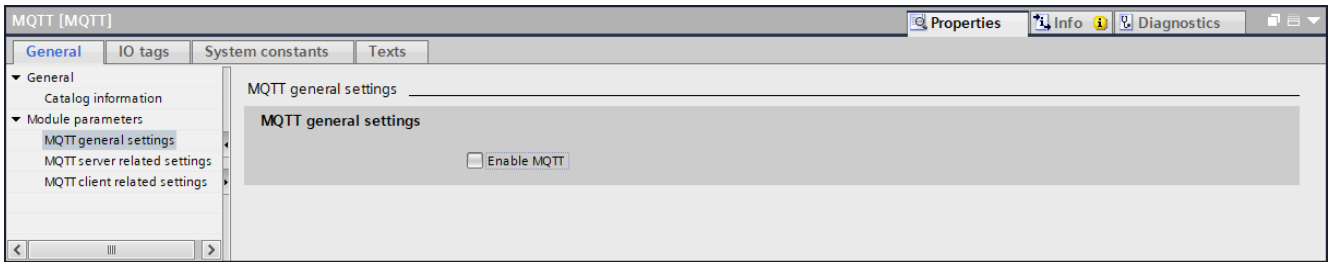

III. 42: Parameter no. 38_General settings

No.	Parameter	Selection (D-Default)	Description
38	Enable MQTT	Off (D)	MQTT is <i>not</i> available.
		On	MQTT is available.

Parameter 39

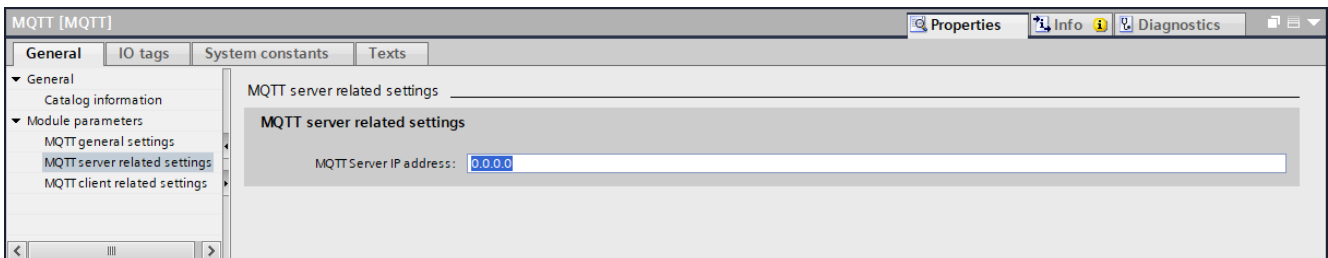

III. 43: Parameter No. 39_Server IP address

No.	Parameter	Selection (D-Default)	Description
39	MQTT Server IP-Address	0.0.0.0	MQTT server IP address.

Parameter 40-42

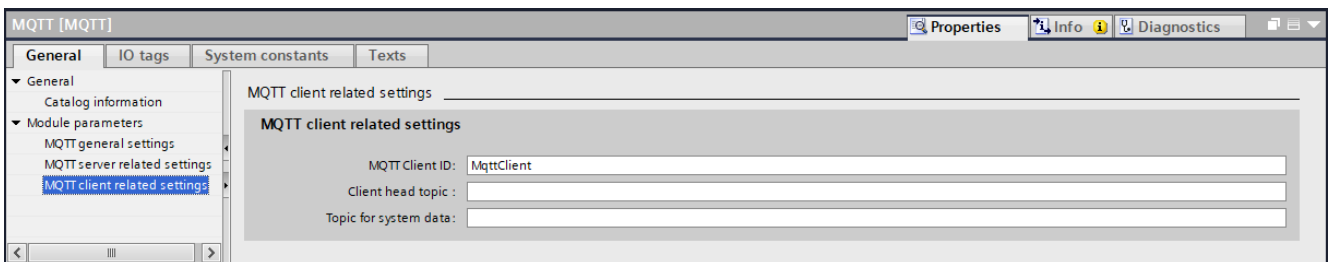

III. 44: Parameter 40, 41, 42_Client settings

No.	Parameter	Selection (D-Default)	Description
40	MQTT Client ID	MqttClient	ID des MQTT Clients
41	Client head topic		Client head topic
42	Topic for system data		Not applied!

9.3.2.3 Submodul 5_OPC UA

Parameter 43-46

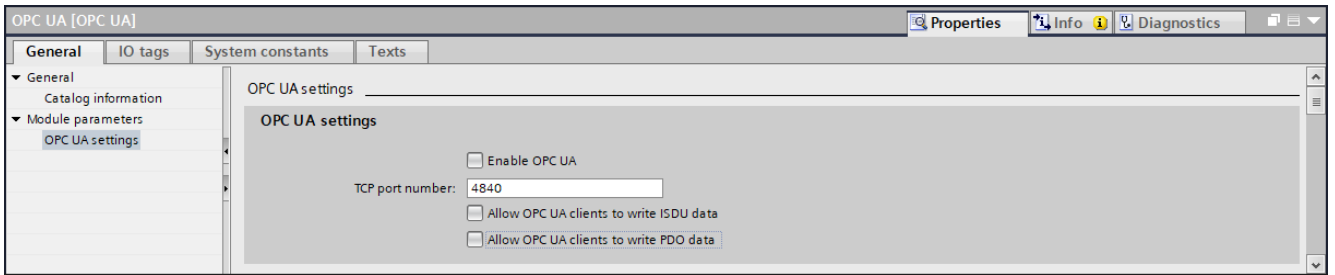

Ill. 45: Parameter 43, 44, 45, 46_OPC UA

No.	Parameter	Selection (D-Default)	Description
43	Enable OPC UA	Off (D)	Disabled. OPS UA <i>not</i> available.
		On	Enabled. OPC UA is available
44	TCP port number	4840	TCP port number
45	Allow OPC UA clients to write ISDU data	Off (D)	Disabled
		On	Enabled
46	Allow OPC UA clients to write PDO data	Off (D)	Disabled
		On	Enabled

9.3.2.4 Submodul 6_JSON

Parameter 47

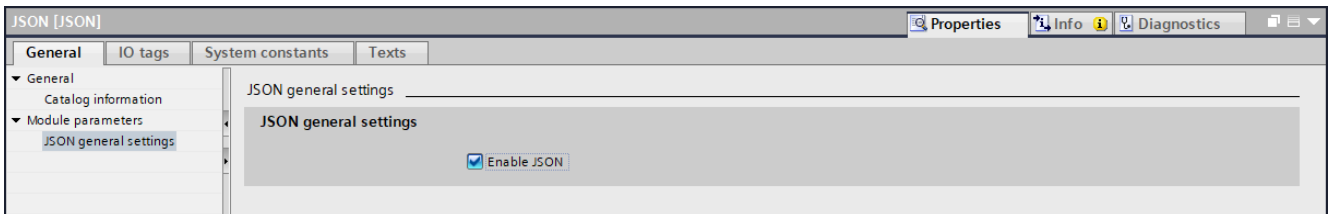

Ill. 46: Parameter no. 47_General settings

No.	Parameter	Selection (D-Default)	Description
47	Enable JSON	Off (D)	Disabled. JSON <i>not</i> available.
		On	Enabled. JSON available.

9.3.2.5 Submodul 7_Webserver

Parameter 48

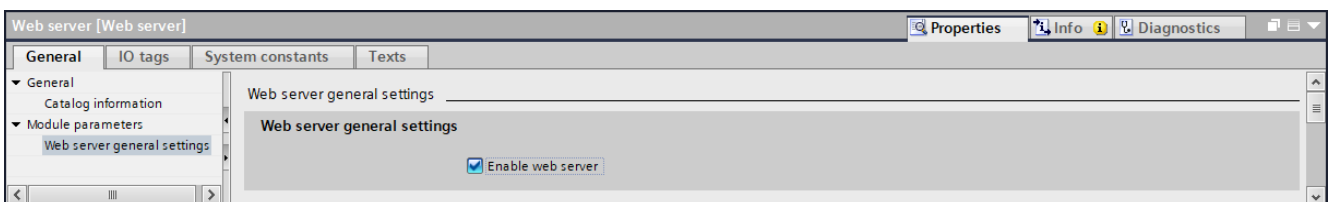

Ill. 47: Parameter No. 48_enable web server

No.	Parameter	Selection (D-Default)	Description
48	Enable web server	Off (D)	Disabled. Web server <i>not</i> available.
		On	Enabled. Web server available.

9.3.2.6 Submodul 8_Output Forcing

Parameter 49

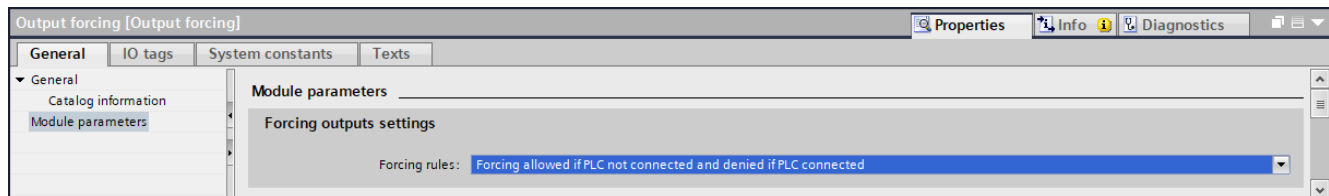

III. 48: Parameter No. 49_Forcing rules



INFO

Output Forcing:

Instead of transferring the controller process data, the data set via Output Forcing is transferred to the outputs. Output Forcing is accessible via Website or OPC UA.

Enable Output Forcing is only feasible if the set forcing rules are met.

No.	Parameter	Selection (D-Default)	Description
49	Forcing rules	Output forcing: <ul style="list-style-type: none"> ▪ permitted if no PLC connection established ▪ not permitted if PLC connection established (D) 	Output forcing of the output data is only allowed with no PLC connection established.
		Output forcing permitted	Output forcing is <i>always permitted</i> , no matter what is the PLC connection status.
		Output forcing not permitted	Output forcing is <i>never permitted</i> , no matter what is the PLC connection status.

9.4 IO-Link configuration

IO-Link configuration

Module *CM50I.PN* provides two ways for for IO-Link device configuration and parameterization:

- IO-Link parameterization via *PROFINET*
- *Baumer Sensor Suite (BSS)*

IO-Link-Integration in *PROFINET*

IO-Link integration in *PROFINET* is a standardized method for accessing IO-Link device parameterization and configuration via *PROFINET* interfaces.

CM50I.PN supports integration V1.0 Edition 2.

**INFO**

For further information please see document *IO-Link-Integration-for-PROFINET_Ed2_2_832_V10_Jun17*.

Baumer Sensor Suite (BSS)

BSS allows for IO-Link device parameterization.

IO-Link data is visualized via a graphical interface and the parameterization of the device is made possible in the simplest possible way.

**INFO**

Software *Baumer Sensor Suite (BSS)* and the corresponding manual is available at *Baumer* website <https://www.baumer.com/bss>.

9.5**Cyclic and acyclic communication**

The IO-Link specification defines three types of data in the transmission between IO-Link master and IO-Link device:

- Cyclic process data (process data objects input/output)
- Acyclic data as device data (on-request data objects)
- Acyclic data as events

Process data objects and their port qualifiers are transmitted cyclically once communication has been established.

Each IO-Link port enables individual parameterization of the transmission time as IO-Link cycle time (parameter *cycle time*).

Process data of the connected device may include 0 to 32 bytes (each input and output) and are transmitted via the set range of addresses.

The device defines the process data size. The port qualifier indicates whether process data is valid.

Device data (on-request data objects) comprise:

- Device parameters
- I&M data records (Identification & Maintenance)
- Diagnostic information

Device data can be written to the device as parameters or read out from the device as device status. Transmission is acyclically and on IO-Link Master request only.

IO-Link events are error messages and warnings/maintenance data.

The device flagging an event is followed by the IO Link master request for diagnostic data. *CM50I.PN* transmits diagnostics data via fieldbus to the control.

For more information on device diagnostics and IO-Link event codes please see chapter Kap. 9.2.3.1 "Description according IO-Link directive of integration edition 2" beschrieben.. "

9.5.1 Acyclic IO-Link access

Acyclic access to different data sections in the IO-Link master or access to IO-Link device data utilizes PN-IO read/write services:

- Read/Write services for I&M data in Master and IO-Link devices.
- IO-Link function block IOL_Call with ISDU (Index Service Data Unit)
 - IOL_Index 0x0000 – 0x7FFF and IOL_Subindex 0x00 – 0xFF

(See: IO-Link Integration Part1 2812_V100_080124 and IO-Link Integration for PROFINET_Ed2_2832_V10_Jun17).

The IO-Link function block supports the following tasks:

- IO-Link device parameterization,
- IO-Link device diagnostics,
- Execute IO-Link port functions,
- save and recover IO-Link device parameters.

The IO-Link function block is provided by the controller manufacturer (e.g. Siemens FB IO_Link_Device for TIA Portal), see chapter 8.5.3 "IO-Link Funktion block".



INFO

For more information please refer to the instruction manual of the related control manufacturer.

9.5.2 I&M-Daten

I&M data acyclic reading may be any time in order to identify the system-installed devices. The system-specific description, location, function and date of installation can be written to the module.

The module supports the following I&M data records:

- IM_Index = 0xAFF0 -> Read access to IM0 IOL_M
- IM_Index = 0xAFF1 -> Read access to IM1 IOL_M
- IM_Index = 0xAFF2 -> Read access to IM2 IOL_M
- IM_Index = 0xAFF3 -> Read access to IM3 IOL_M
- IM_Index = 0xAFF4 -> Read access to IM4 IOL_M
- IM_Index = 0xB063 -> Read access to IOL_M Directory

I&M0 (Slot0, Index 0xAFF0)

I&M0 Data	Size in bytes/access (read/write)	Description
VendorID	2 / r	Manufacturer ID
OrderID	20 / r	Product name
IM_Serial_Number	16 / r	Device serial number
IM_Hardware_Revision	2 / r	Device hardware revision
IM_Software_Revision	4 / r	Device software revision (V0.0.0)
IM_RevisionCounter	2 / r	Revision counter

I&M0 Data	Size in bytes/access (read/write)	Description
IM_Profile_ID	2 / r	ID IO-Link sub module profile (API = 0x4E01)
IM_Profile_Specific_Type	2 / r	Additional profile value (= 0 not used)
IM_Version	2 / r	I&M-Version (Default 0x0101)
IM_Supported	2 / r	Supported I&M data records (e.g. 0x0001 -> only I&M0 is supported)

Tab. 14: I&M0 data record

I&M1 (Slot0, Index 0xAFF1)

I&M1 Data	Size in bytes/access (read/write)	Description
TagFunction of submodule	32 / r/w	Device function
TagLocation of submodule	22 / r/w	Device location within the system

Tab. 15: I&M1 data record

I&M2 (Slot0, Index 0xAFF2)

I&M2 Data	Size in bytes/access (read/write)	Description
Installation_Date	16 / r/w	Device installation date

Tab. 16: I&M2 data record

I&M3 (Slot0, Index 0xAFF3)

I&M3 Data	Size in bytes/access (read/write)	Description
Descriptor	54 / r/w	Device description

Tab. 17: I&M3 data record

Reading of I&M data record**Function block RDREC_Instance in the TIA portal**

Website
http://support.industry.siemens.com

Example: I&M Index 0xAFF0



Ill. 49: Function Block RDREC_Instance

RDREC block	Functionality
RDREC_Instance	This function block is used

RDREC block	Functionality
	<ul style="list-style-type: none"> for acyclic reading via S7-program I&M data

9.5.3 IO-Link function block

IO_LINK_DEVICE function block in TIA Portal

The IO-Link function block is included in the library *IO_LINK_Library_V14.zal14*.

Library	Website
IO_LINK_Library_V14.zal14	http://support.industry.siemens.com

Function block **IO_LINK_DEVICE** in the TIA Portal is similar to *IOL_CALL*. *IOL_CALL* is defined in the IO-Link specification.



III. 50: Function block IO-Link device

IO-Link block	Functionality
IO_LINK_DEVICE	This function block is used <ul style="list-style-type: none"> for acyclic writing of device parameters to an IO-Link device via S7 program for reading parameters, measured values and diagnostic data from an IO-Link device

Input parameters

Parameter	Data type	Description
REQ	BOOL	Positive edge: initiate data transmission
ID	HW_IO	For S7-1200/1500 Hardware ID of the IO-Link communication module
	DWORD	For S7-300/400 Logical address of the IO-Link communication module (module or sub module)
CAP	DINT (S7-1200/1500)	Client Access Point (CAP = 0xB400)
	INT (S7-300/400)	
RD_WR	BOOL	Read or write access 0: read 1: write
PORT	INT	Port number the IO-Link device is operated at. Permitted values: 0 ... 63 Port 0 IO-Link Master Modul; Port 1 IO-Link device on port 1, etc.

Parameter	Data type	Description
IOL_INDEX	INT	Number of IO-Link index to be read out or described
IOL_SUBINDEX	INT	Number of IO-Link sub index to be read out or described; 0: entire record 1 ... 255: parameter of record
LEN	INT	Length of data to be written (net data) Read: 0 ... 232 (not relevant) Wrote 1 ... 232

Tab. 18: IO_LINK_DEVICE Input parameters

Output parameters

Parameter	Data type	Description
DONE_VALID	BOOL	Validity: 0: data not valid 1 = data valid
BUSY	BOOL	Order in progress: 0: order completed (valid or error) 1: Order in progress
ERROR	BOOL	Error status: 0: no error 1: aborted with error
STATUS	DWORD	ERROR = 1 -> function error, see table 8-19: "IO_LINK_DEVICE - Parameter STATUS" and Tab. 8-20: "IO_LINK_DEVICE - Parameter STATUS error code" ERROR = 0 -> status of function DW#16#000x0000 (x: processing step 0 ... 3)
IOL_STATUS	DWORD	ERROR = 1 -> IO Link error or communication error, see tab. 8-21: "IOL M Error Codes"
RD_LEN	INT	Length of the read data (net data)

Tab. 19: IO_LINK_DEVICE Output parameters

Input and output parameters

Parameter	Data type	Description
RECORD_IOL_D ATA	ARRAY [0 ... 231] of BYTE	Source and target areas for the data to be read and to be written

Tab. 20: IO_LINK_DEVICE Input and output parameters

Parameter STATUS

The STATUS is composed of 4 bytes:

Byte 3	Byte 2	Byte 1	Byte 0
Manufacturer-specific ID	0x80 defines error as acyclic communication error	STATUS Code	Manufacturer-specific ID

Tab. 21: IO_LINK_DEVICE - Parameter STATUS

Status-Code	Name	Description
0xFF000000	TIMEOUT	Internal error module communication error
0x00FFFF00	INVALID_HANDLE	
0x00FFFE00	HANDLE_OUT_OF_BUFFERS	
0x00FFFD00	HANDLE_DESTINATION_UNAVAILABLE	
0x00FFFC00	HANDLE_UNKNOWN	
0x00FFFB00	HANDLE_METHOD_INVALID	
0xxx80A0xx	MASTER_READ_ERROR	Reading error
0xxx80A1xx	MASTER_WRITE_ERROR	Writing error
0xxx80A2xx	MASTER_MODULE_FAILURE	IO-Link master failure, potential bus error
0xxx80A6xx	MASTER_NO_DATA	No data received
0xxx80A7xx	MASTER_BUSY	IO-Link master busy
0xxx80A9xx	MASTER_FEATURE_NOT_SUPPORTED	Feature not supported by IO-Link Master
0xxx80AAxx	MASTER_RESOURCE_UNAVAILABLE	IO-Link Master not available
0xxx80B0xx	ACCESS_INVALID_INDEX	Index invalid, incorrect <i>INDEX_CAP</i>
0xxx80B1xx	ACCESS_WRITE_LENGTH_ERROR	Module cannot process data length to be written, maybe you are addressing the wrong module
0xxx80B2xx	ACCESS_INVALID_DESTINATION	Incorrect slot addressing
0xxx80B03xx	ACCESS_TYPE_CONFLICT	<i>IOL_CALL</i> invalid
0xxx80B5xx	ACCESS_STATE_CONFLICT	error in sequence <i>IOL_CALL</i>
0xxx80B6xx	ACCESS_DENIED	Access denied by IO-Link Master block
0xxx80C2xx	RESOURCE_BUSY	IO-Link Master module busy resp. awaiting reply of connected IO-Link device
0xxx80C3xx	RESOURCE_UNAVAILABLE	
0xxx8901xx	INPUT_LEN_TOO_SHORT	The index to be read contains more data than specified in input variable <i>LEN</i>

Tab. 22: IO_LINK_DEVICE - Parameter STATUS error code

IOL_STATUS

The IOL_STATUS comprises the 2-byte IOL M error code and 2-byte IOL error type.

FB IO_LINK_DEVICE - Parameter IOL_STATUS / IOL M Error Codes

IOL M Error Codes (2 bytes)		
Error Code	Designation according to specification.	Description
0x0000	No error	no error
0x7000	IOL_CALL conflict	Unexpected write request, read request expected
0x7001	Wrong IOL_CALL	Decoding error
0x7002	Port blocked	Port blocked by another task
...	Reserved	-
0x8000	Timeout	Timeout, IOL master or IOL device ports busy
0x8001	Wrong index	Error: IOL index specified <32767 or >65535
0x8002	Wrong port address	Port address not available
0x8003	Wrong port function	Port function not available
...	Reserved	-

Tab. 23: IOL M Error Codes

FB IO_LINK_DEVICE - Parameter IOL_STATUS / IOL Error Types

IOL Error Types (2 bytes)		
Error Code	Designation according to specification.	Description
0x1000	COM_ERR	Communication error Potential cause: The addressed port is parameterized as DI and not in IO-Link mode
0x1100	I_SERVICE_TIMEOUT	Communication timeout, maybe device reply delayed
0x5600	M_ISDU_CHECKSUM	Master is reporting checksum error, device not accessible
0x5700	M_ISDU_ILLEGAL	Device cannot process master request
0x8000	APP_DEV	Device application error
0x8011	IDX_NOTAVAIL	Index not available
0x8012	SUBIDX_NOTAVAIL	Subindex not available
0x8020	SERV_NOTAVAIL	Service temporarily unavailable
0x8021	SERV_NOTAVAIL_LOCCTRL	Service temporarily unavailable, device busy (e.g. on-device teaching/ parametrization is active)
0x8022	SERV_NOTAVAIL_DEVCTRL	Service temporarily unavailable, device busy (e.g. device teaching/parameterization via DTM/PLC etc is active)
0x8030	PAR_VALOUTOFRNG	Parameter value outside valid range
0x8031	PAR_VALGTLIM	Parameter value exceeds maximum limit
0x8032	PAR_VALLTLIM	Parameter value below minimum limit

IOL Error Types (2 bytes)		
Error Code	Designation according to specification.	Description
0x8033	VAL_LENVERRUN	Length of the data to be written does not match the defined parameter length
0x8034	VAL_LENUNDRUN	
0x8035	FUNC_NOTAVAIL	Function in device unavailable
0x8036	FUNC_UNAVAILTEMP	Function in device temporarily unavailable
0x8040	PARA_SETINVALID	Set parameter invalid: May not match the general device parameterization
0x8041	PARA_SETINCONSIST	Set parameter not consistent
0x8082	APP_DEVNOTRDY	Application not ready, device busy
0x8100	UNSPECIFIC	Manufacturer-specific according to device documentation
0x8101 bis	VENDOR_SPECIFIC	
0x80FF		

Tab. 24: IOL Error Types

9.6 Basic settings

9.6.1 Topology

PROFINET offers numerous functions as well as options for diagnostics and maintenance based on the existing topology or utilizing knowledge of this topology.

All *CM50I.PN* support the topology settings and automatic topology recognition by the Engineering Tool.

The section below describes how to set the *CM50I.PN* topology. The settings for connected neighboring devices are made via the ports **X1 P1** and **X1 P2**, which represent the physical interfaces.

Tab **Port interconnection | Partner port** provides under menu item **Partner port** a list of all ports for the devices in the project.

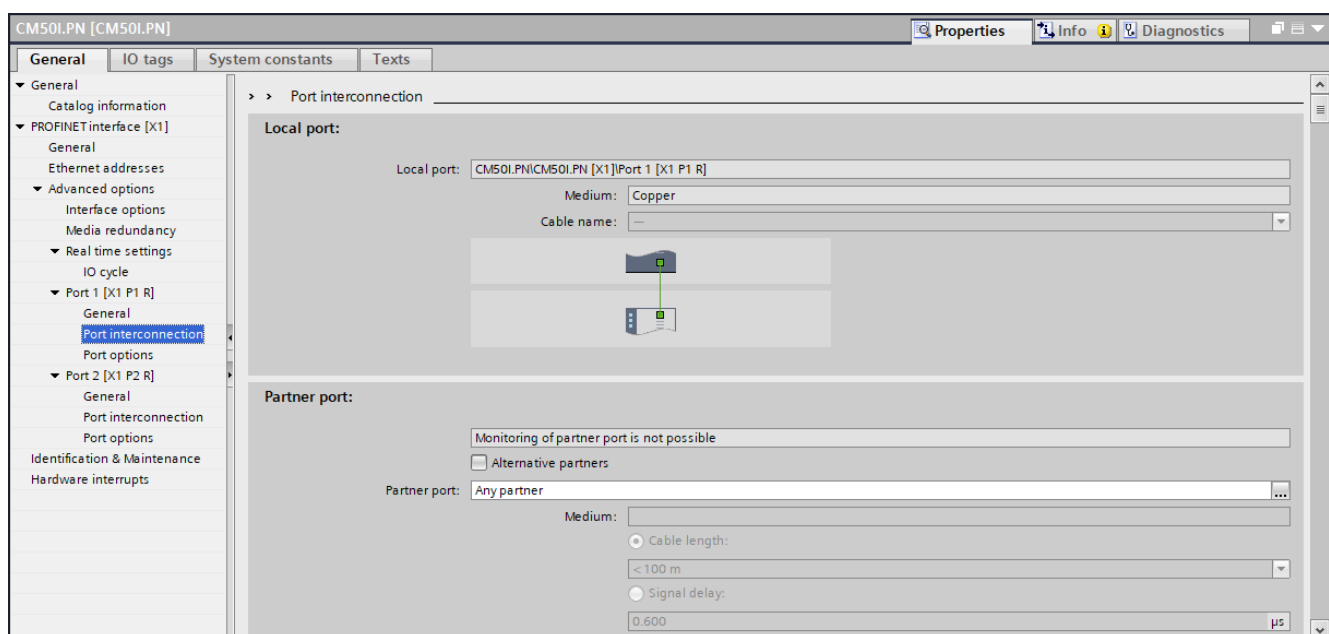

III. 51: Topology description

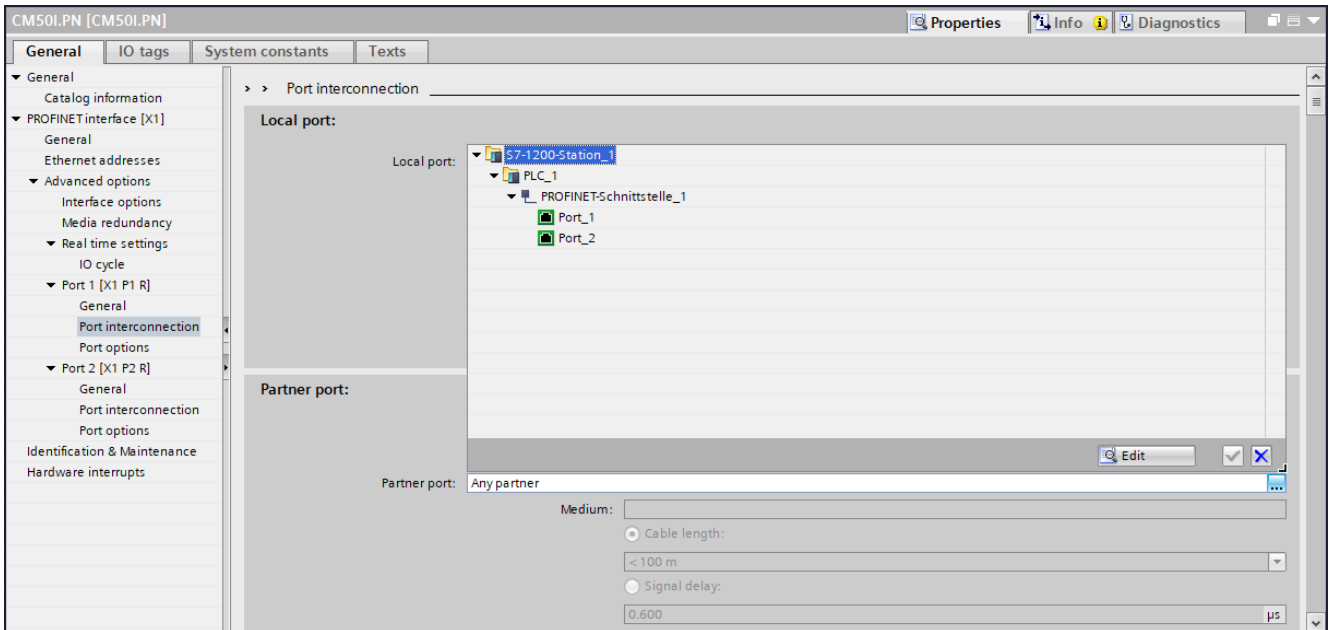

/// 52: Topology description

Module identification in the network

PNIO devices identify by their MAC address and the respective module type.

Putting several modules of the same type into operation requires them to be clearly differentiated from one another.

Using the following path and selecting the **PN/IE_1** network in the network view, you can search for available users **Online | Assign PROFINET device name**.

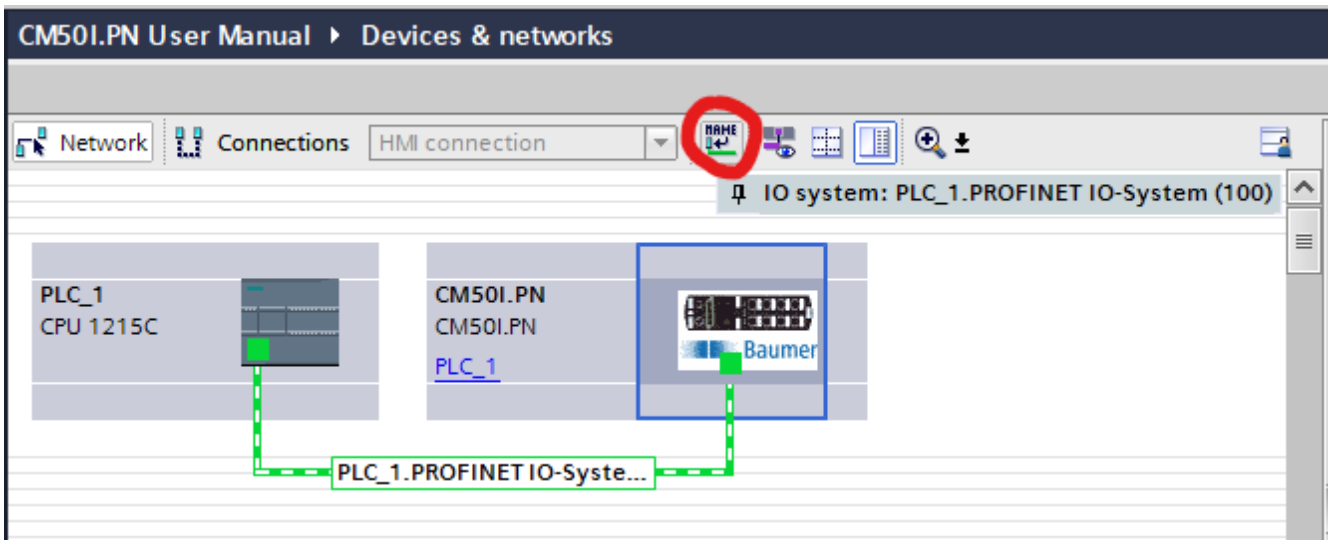

/// 53: Identify individual modules in the network

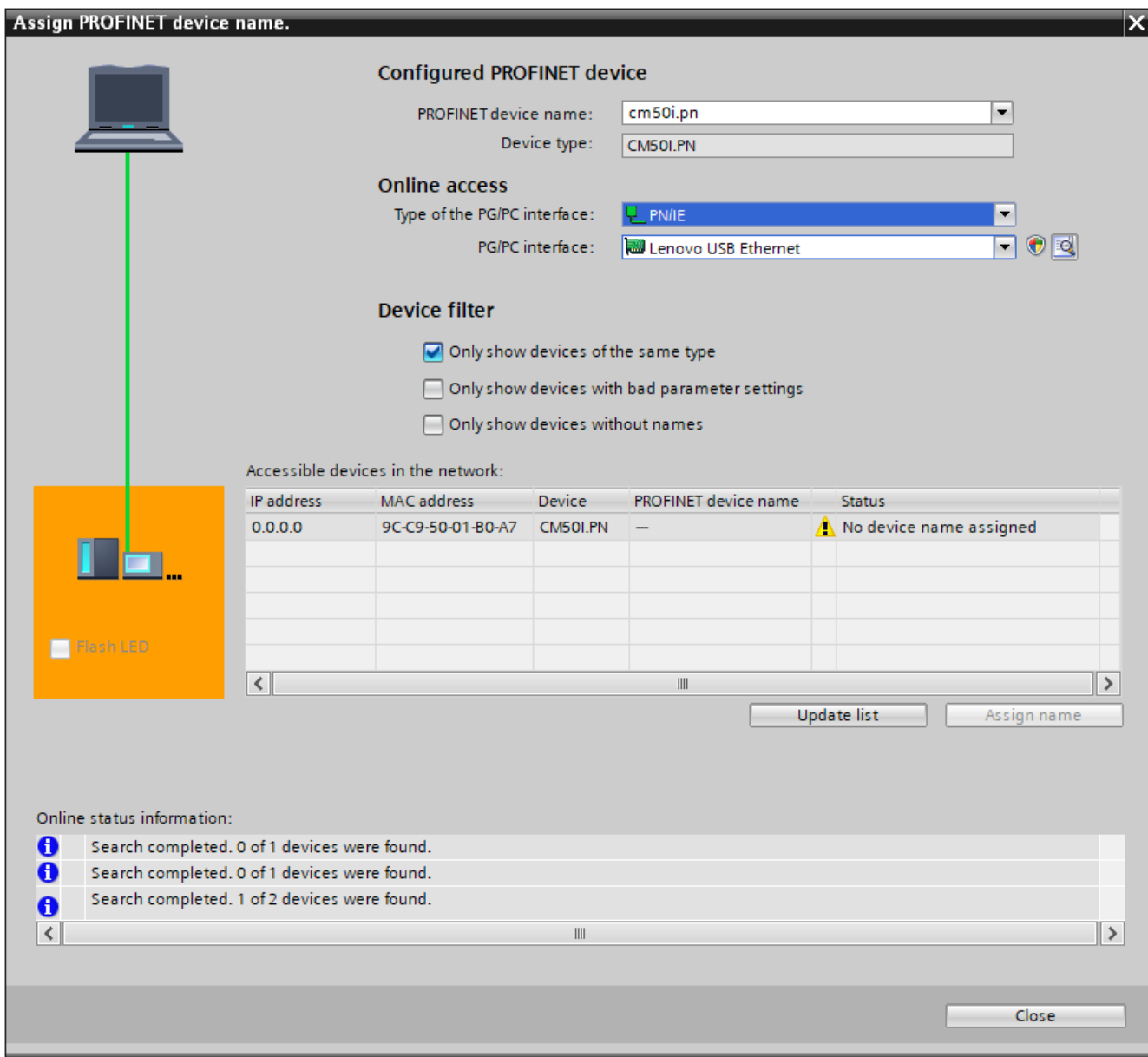

III. 54: Identify individual modules in the network

Device identifies by flashing. The LEDs of the selected *CM501.PN* start flashing.

Instruction:

- a) | Mark the available module.
- b) Select option **LED flashing**.

Also see about this

[LED indicator \[▶ 115\]](#)

9.6.2 PROFINET device name

Assigning the PROFINET device name

Once having clearly identified a module, you can assign it a name.

The PNIO controller will automatically assign the IP address via *DCP (Discovery and Configuration Protocol)*.

Address and name resolution are only managed via the name remanently saved in this module.

Instruction:

- a) Select module.
- b) Click **Assign name**.

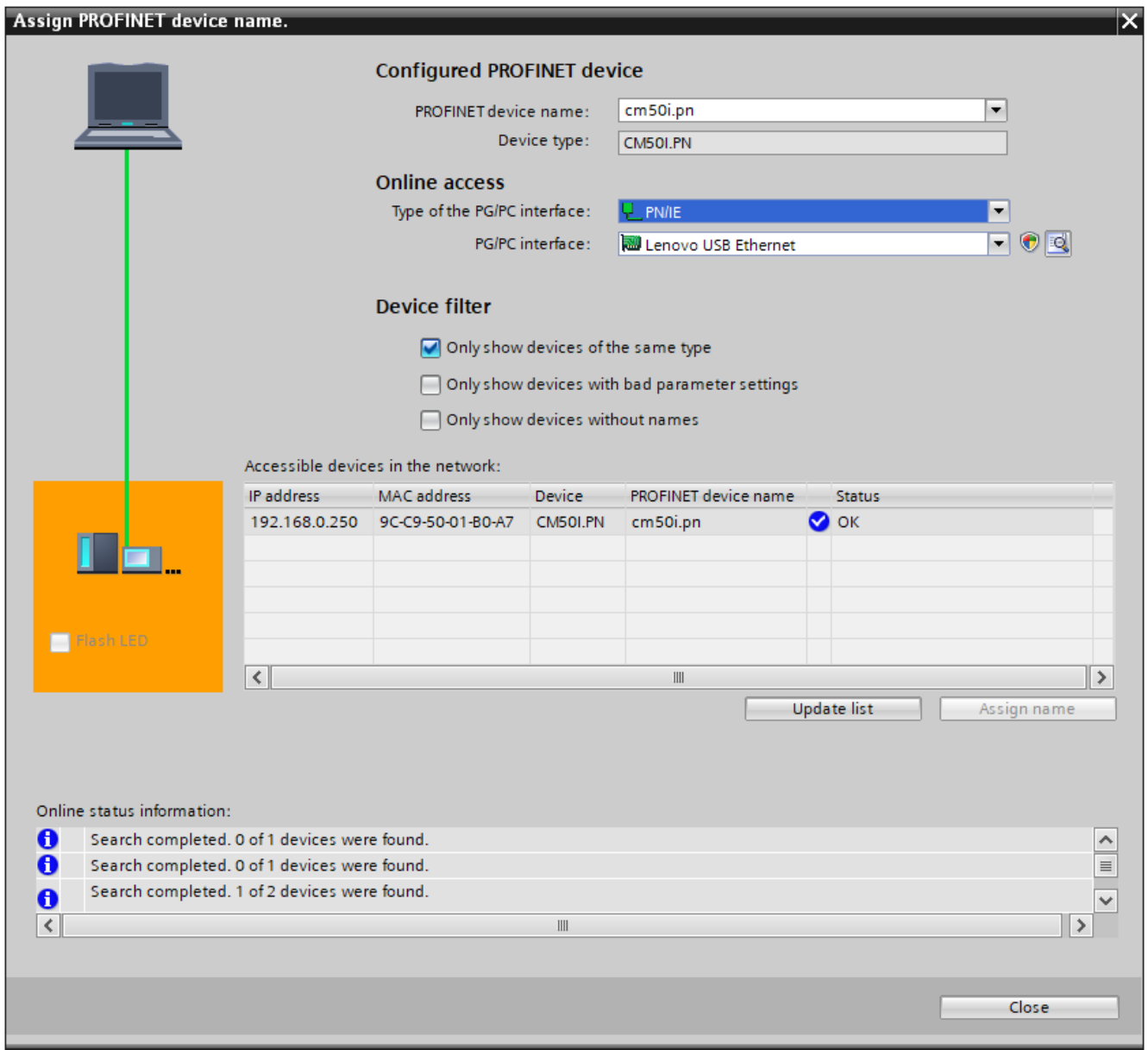

///. 55: PROFINET device name

TIA Portal now indicates the module *CM50I.PN* and the new assigned device name..

IP address assignment

You can assign an IP address to module *CM50I.PN* which will not be stored in the module. To do so, enter the required IP address and the subnet mask to be used.

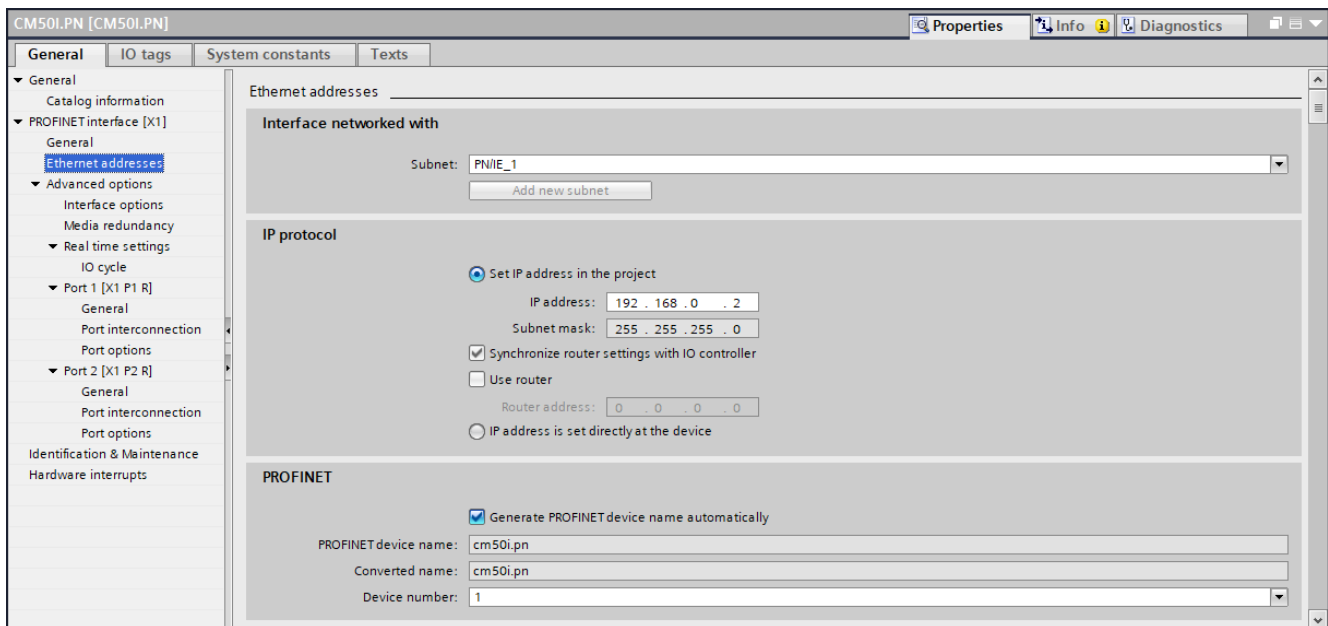

III. 56: IP address assignment

In tab **Properties** | **General**

- ◆ Double-click **Ethernet addresses**.

9.6.3 Default settings

Restore default

Function **Restore default - retain I&M data** will reset the module to the default settings while retaining the I&M data saved in the memory.

Proceed as follows:

Instruction:

- Click **Connect online** in the **TIA Portal**.
- Once connection has been established, select the related module.
- In the project navigator, open module **MVK-MPNIO**. Double-click **Online & Diagnostics**.
- Under tab **Functions** click **Restore default** to open a dialog window.
- Select **Retain I&M data**.
- Click button **Reset**.

Result:

- ✓ Module is reset to default.

Restore default - default parameters

Settings	Value
IP address	0.0.0.0
Subnet mask	0.0.0.0
Router address	0.0.0.0
PROFINET device name	Blank

Tab. 25: Restore default - default parameters

Restore default - I&M parameters

I&M parameters	Value
Installation ID	Blank
Location ID	Blank
Installation date	Blank
Description	Blank
Additional information	Blank

Tab. 26: Restore default - I&M parameters

Restore default - retain I&M data

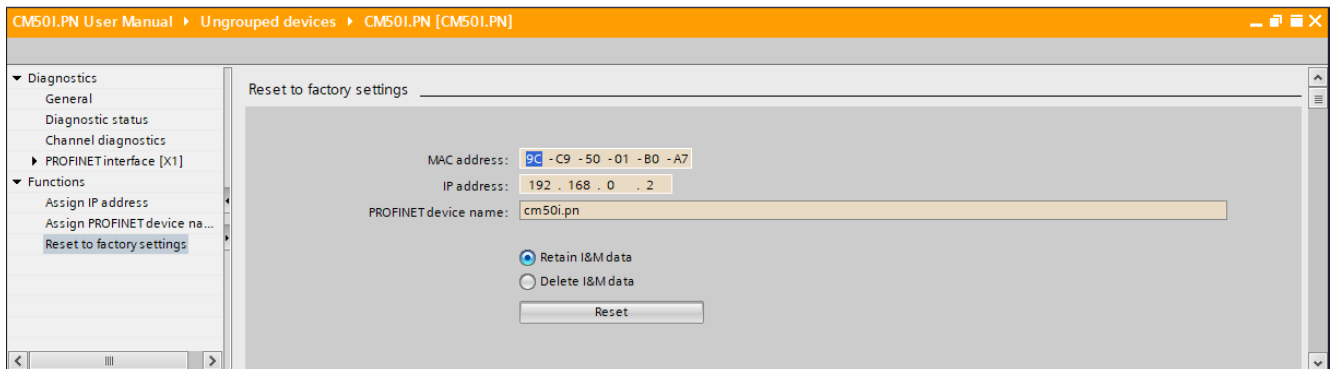

III. 57: Restore default - retain I&M data

Restore default - delete I&M data

The function **Restore default - delete I&M data** restores default settings in the module and at the same time deletes the I&M data stored in memory.

Proceed as follows:

- a) Click **Connect online** in the **TIA Portal**.
- b) Once connection has been established, select the related module.
- c) In the project navigator, open module **MVK-MPNI0**. Double-click **Online & Diagnostics**.
- d) Under tab **Functions** click **Restore default** to open a dialog window.
- e) enable selection **delete I&M data**.
- f) Click button **Reset**.

Result:

- ✓ Module is reset to default.

Restore default - delete I&M data

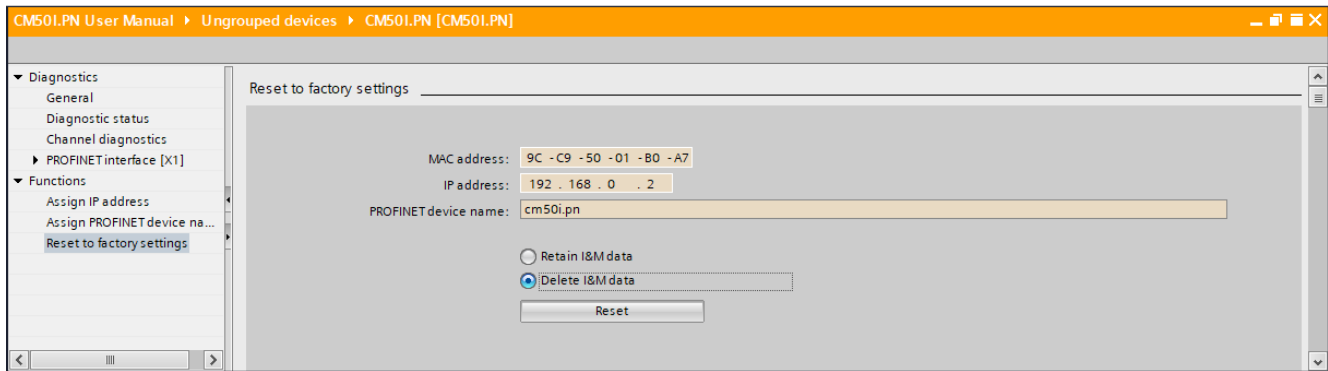

III. 58: Restore default, delete I&M data

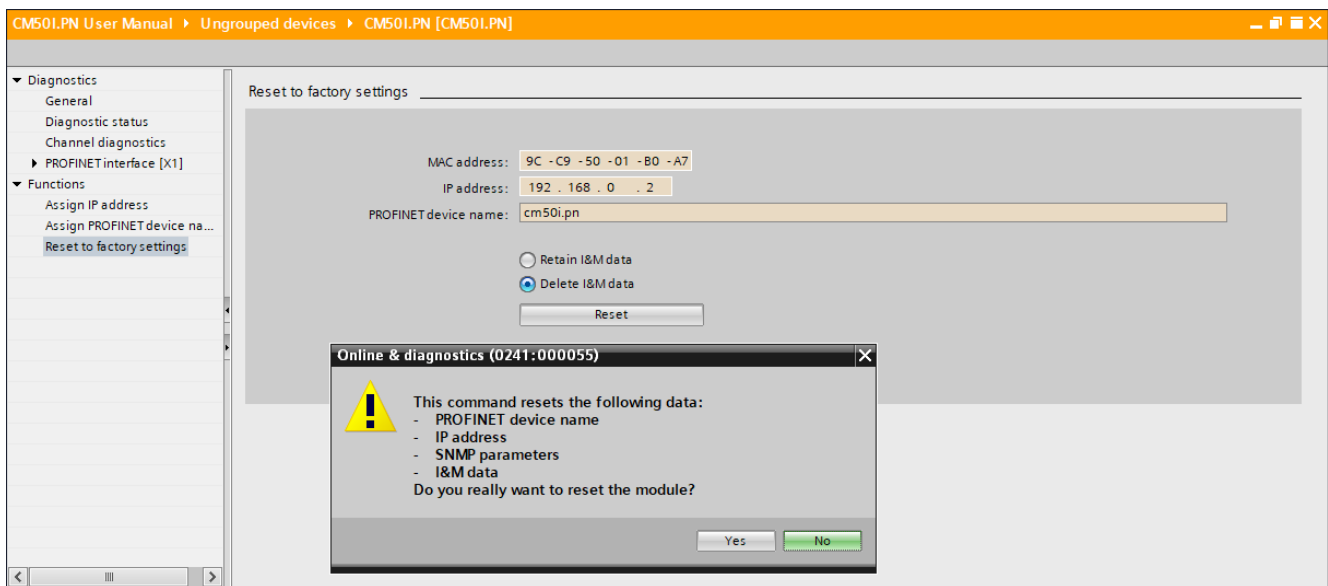

III. 59: Restore default, delete I&M data - confirmation dialog

9.7 Media Redundancy Protocol (MRP) configuration

How to configure media redundancy is described in the engineering software manual.

This document describes a configuration via the *Siemens TIA Portal Engineering Software*.

Preparation:

Instruction:

- a) Set up a project in the *TIA Portal*.
- b) Add a **controller** with two ports or an additional *PROFINET Managed Switch*.
- c) Add the *CM50I.PN* device.
- d) Assign the *CM50I.PN* device to the controller (see **MRP-Manager**).

MRP manager setup

A ring configuration requires 2 ports of a *PROFINET Managed Switch* or *S7 CPU* to be configured as ring managers and all remaining users as clients.

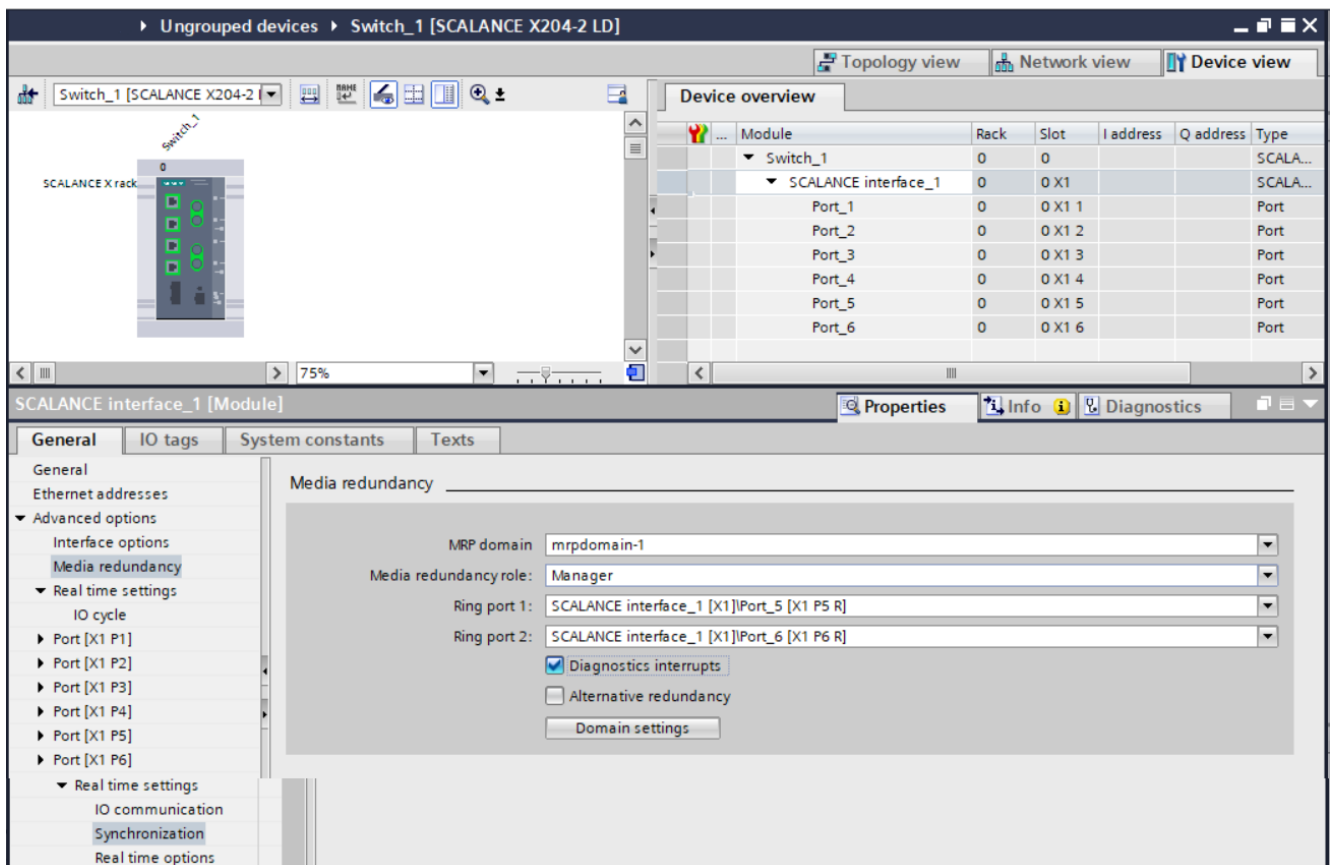

III. 60: MRP manager setup

- a) Select *PROFINET Managed Switch*.
- b) Navigate to menu item **PROFINET interface** | **Advanced options** | **Media redundancy**.
- c) Under **Media redundancy role** select *Manager (Auto)*.
- d) | Enable the selectionenable **Diagnostics interrupts**.

Setting up MRP client

The screenshot shows the 'Device overview' table and the 'Media redundancy' configuration window.

Module	Rack	Slot	I address	Q address	Type	Article no.	Firmware
CM501.PN	0	0			CM501.PN	11261571	V1.3.0
CM501.PN device_1	0	1			CM501.PN device		
SIO data / Module param...	0	1 1	2...3	2...3	SIO data / Module p...		
Standard digital input	0	1 X0 (...)			Standard digital inp...		
Standard digital output	0	1 X1 (...)			Standard digital ou...		
Deactivated	0	1 X2 (...)	4		Deactivated		
IO-Link In 02 bytes + PQI	0	1 X3 (...)	5...8		IO-Link In 02 bytes ...		
IO-Link Out 01 byte + PQI	0	1 X4 (...)	9...10	4...5	IO-Link Out 01 byt...		
IO-Link In/Out 02/02 byt...	0	1 X5 (...)	11...14	6...7	IO-Link In/Out 02/0...		
IO-Link In/Out 08/02 byt...	0	1 X6 (...)	15...24	8...9	IO-Link In/Out 08/0...		
IO-Link In/Out 08/02 byt...	0	1 X7 (...)	25...34	10...11	IO-Link In/Out 08/0...		
CM501.PN options_1	0	2			CM501.PN options		
Qualifier DI	0	2 1	35...36		Qualifier DI		
Qualifier DO	0	2 2	37...38		Qualifier DO		
System state	0	2 3	39...42		System state		
MQTT	0	2 4			MQTT		
OPC UA	0	2 5			OPC UA		
JSON	0	2 6			JSON		
Web server	0	2 7			Web server		
Output forcing	0	2 8			Output forcing		

The 'Media redundancy' configuration window shows the following settings:

- MRP domain: mrpdomain-1
- Media redundancy role: Client
- Ring port 1: CM501.PN [X1]Port 1 [X1 P1 R]
- Ring port 2: CM501.PN [X1]Port 2 [X1 P2 R]
- Diagnostics interrupts

III. 61: Setting up MRP client

- Select module *CM501.PN*.
- Navigate to menu item **PROFINET interface | Advanced options | Media redundancy**.
- Set *client* for **media redundancy role**.
- Activate **diagnostic alarms**.

Note: The *CM501.PN* module must be located in the same MRP domain.

Setting up the MRP cycle times

If media redundancy has been set, the IO cycle times must be parameterized for each module.

According to the PLC, RT requirements and system advancement requires setting the IO cycle times and factors in the following window.

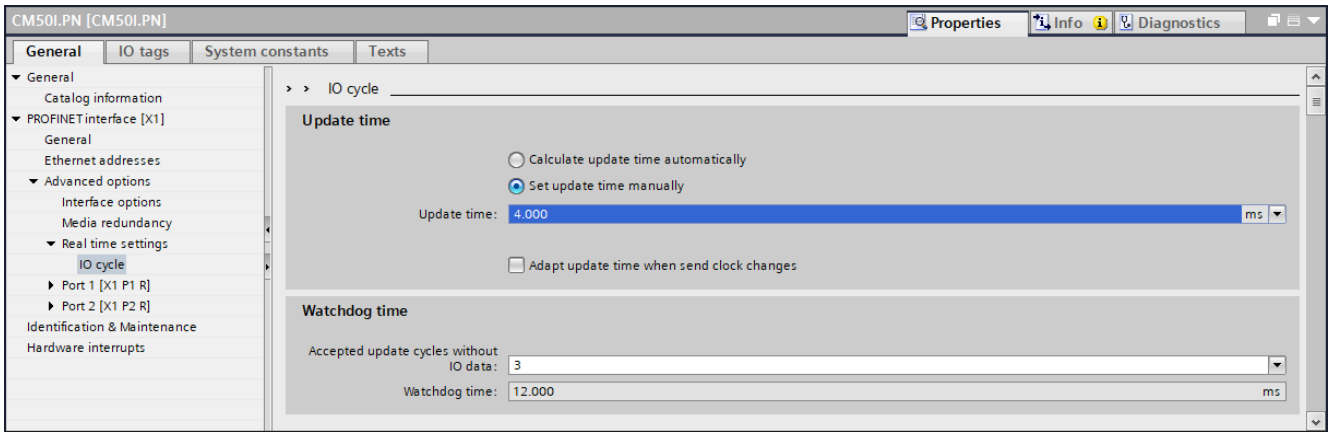

III. 62: Setting up the MRP cycle times

- Navigate to menu item **PROFINET interface | advanced options | media redundancy | IO cycle**.
- Enter the parameter values: *Update time* and *Accepted update cycles without IO data*

Setting up MRP domain

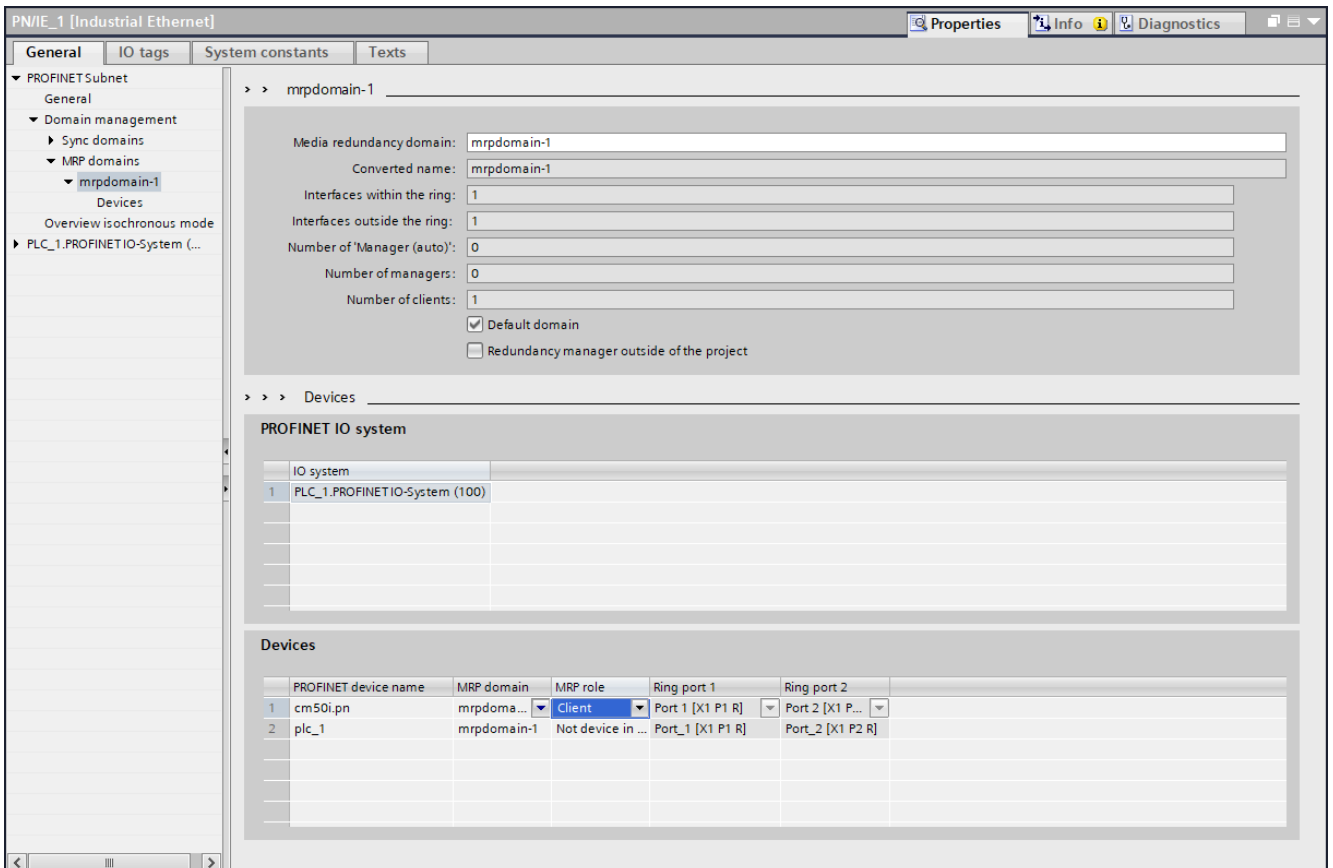

III. 63: Setting up MRP domain

- For an overview of ring users, navigate to menu item **Domain-Management | MRP-Domains | mrpdomain-1**.
- Assign the *PROFINET Managed Switch* to IO controller.
- Save the project.
- Click **PNIE sub net**.
 - ✓ Bus *PLC_1.PROFINET IO-System (100)* appears.
- Assign module *MVK-MPNIO* to the IO controller.

Result:

- ✓ All users of the ring configuration are listed under **Devices**.

Also see about this

 [Media redundancy \(MRP\) \[▶ 16\]](#)

9.8 Isochronous-Real-Time (IRT) configuration

IRT

You will find the procedure for configuring IRT operation in the manual for your engineering software.

This document describes a configuration via the *Siemens TIA Portal Engineering Software*. This communication type requires specialized real-time capable hardware components (IRT).

**INFO**

The device is no active user in IRT data exchange. It supports transmission of IRT telegrams without loss for synchronized fieldbus devices in the same Ethernet subnet.

Preparation:

- Set up a project in the *TIA Portal*.
- Add an IRT-capable controller.
- Add the device.
- Connect the *PROFINET* interfaces.

**INFO**

Make sure that media redundancy is not set (see chapter 8.7 "Media Redundancy Protocol (MRP) configuration").

IRT communication: Setting up the Sync master**INFO**

This procedure describes the projecting of non-synchronized IRT communication. For how to set up clock-synchronized IRT communication please refer to the manual of your engineering software.

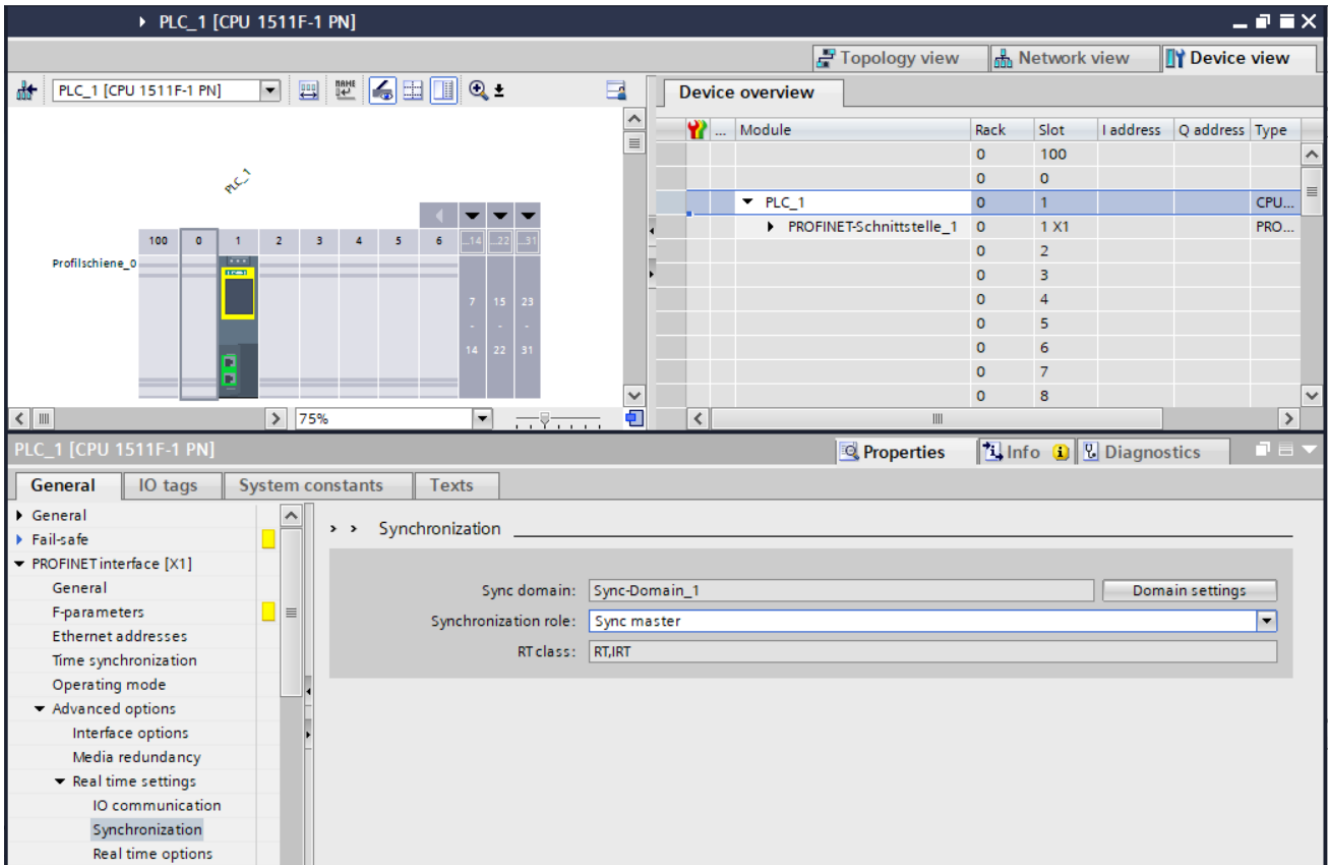

III. 64: IRT communication: Setting up the Sync master

- Double click **Controller PLC_1**.
- Navigate to menu item **Advanced Options | Real time settings | Synchronisation**.
- For **Synchronisation role** select **Sync-Master**.

IRT communication: Setting up Sync-Slave

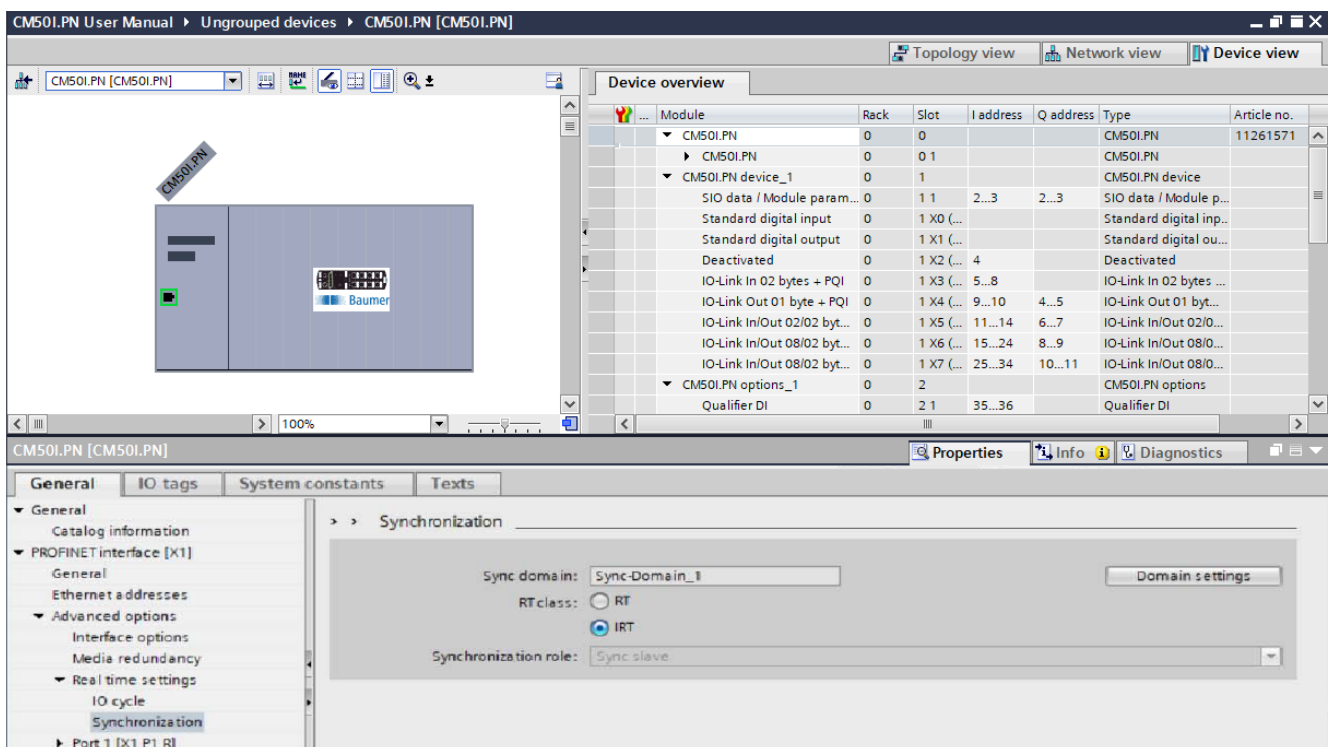

III. 65: IRT communication: Setting up Sync-Slave

Also see about this

 [Isochronous-Real-Time \(IRT\) \[▶ 18\]](#)

9.9 Simple Network Management Protocol (SNMP)

Transmitting SNMP request

- | | |
|-----------------|---|
| <i>Request</i> | On request, <i>Baumer CM50I.PN</i> will transmit a SNPM message. <ul style="list-style-type: none">▪ SNMPv2-MIB:sysDescr.0 Objekt (1.3.6.1.2.1.1.1.0) |
| <i>Response</i> | Device response structure: <ul style="list-style-type: none">▪ Baumer, CM50I, Art.-No., HW version, SW version, MAC address. |

9.10 Industrial Internet of Things (IIoT)

9.10.1 JSON

JSON standard settings

No.	REST API URL	Description	Supporting
1	GET /iolink/v1/gateway/identification	Identification of the gateway	Yes
2	GET /iolink/v1/gateway/capabilities	Capabilities of the gateway	Yes
3	GET /iolink/v1/gateway/configuration	Read network configuration of the gateway	Yes
4	POST /iolink/v1/gateway/configuration	Write network configuration of the gateway	Yes
5	POST /iolink/v1/gateway/reset	Reset the gateway including all masters	-
6	POST /iolink/v1/gateway/reboot	Reboot the gateway including all masters	-
7	GET /iolink/v1/gateway/events	Event log containing all events from gateway, masters, ports, and devices	Yes
8	GET /iolink/v1/masters	Get all available master number keys and identification information	Yes
9	GET /iolink/v1/masters/\$MASTER_NUMBER/capabilities	Capabilities of the master	Yes
10	GET /iolink/v1/masters/\$MASTER_NUMBER/identification	Read identification of the master	Yes
11	POST /iolink/v1/masters/\$MASTER_NUMBER/identification	Write identification of the master	Yes
12	GET /iolink/v1/masters/\$MASTER_NUMBER/ports	Get all available port number keys	Yes
13	GET /iolink/v1/masters/\$MASTER_NUMBER/ports/\$PORT_NUMBER/capabilities	Read capability information of the specified port	Yes
14	GET /iolink/v1/masters/\$MASTER_NUMBER/ports/\$PORT_NUMBER/status	Read status of the master	Yes
15	GET /iolink/v1/masters/\$MASTER_NUMBER/ports/\$PORT_NUMBER/configuration	Read configuration of the specified port	Yes
16	POST /iolink/v1/masters/\$MASTER_NUMBER/ports/\$PORT_NUMBER/configuration	Write configuration of the specified port	Yes
17	GET /iolink/v1/masters/\$MASTER_NUMBER/ports/\$PORT_NUMBER/datastorage	Read data storage content of the specified port	Yes
18	POST /iolink/v1/masters/\$MASTER_NUMBER/ports/\$PORT_NUMBER/datastorage	Write data storage content of the specified port	Yes
19	GET /iolink/v1/devices	Address all devices of all masters	Yes

No.	REST API URL	Description	Supporting
20	GET /iolink/v1/devices/{deviceAlias}/capabilities	Read capability information of the specified device	Yes
21	GET /iolink/v1/devices/{deviceAlias}/identification	Read identification information of the specified device	Yes
22	POST /iolink/v1/devices/{deviceAlias}/identification	Write identification information of the specified device	-
23	GET /iolink/v1/devices/{deviceAlias}/processdata/value?format=byteArray	Read process data value from the specified device	Yes
24	GET /iolink/v1/devices/{deviceAlias}/processdata/getdata/value?format=byteArray	Read process data input value from the specified device	Yes
25	GET /iolink/v1/devices/{deviceAlias}/processdata/setdata/value?format=byteArray	Read process data output value from the specified device	Yes
26	POST /iolink/v1/devices/{deviceAlias}/processdata/value	Write the process data output value to the specified device	Yes
27	GET /iolink/v1/devices/{deviceAlias}/parameters/{index}/value/?format=byteArray	Read a specific parameter value and its sub-parameter values (if the parameter has complex type) with the given index of the device	Yes
28	GET /iolink/v1/devices/{deviceAlias}/parameters/{index}/subindices/{subindex}/value/?format=byteArray	Read the value of a specific sub-parameter with the given index and subindex	Yes
29	GET /iolink/v1/devices/{deviceAlias}/parameters/{parameterName}/value/?format=byteArray	Read a specific parameter value with the given name	-
30	POST /iolink/v1/devices/{deviceAlias}/parameters/{index}/value	Write the parameter with the given index to the device	Yes
31	POST /iolink/v1/devices/{deviceAlias}/parameters/{parameterName}/value	Write the parameter with the given name to the device	-
32	POST /iolink/v1/devices/{deviceAlias}/parameters/{index}/subindices/{subindex}/value	Write the sub-parameter with the given index and subindex to the device	Yes
33	POST /iolink/v1/devices/{deviceAlias}/parameters/{parameterName}/subindices/{subParameterName}/value	Write the sub-parameter with the given parameter name and sub-parameter name to the device	-
34	POST /iolink/v1/devices/{deviceAlias}/blockparametrization/?format=byteArray	Read or write one or more parameters as a block	Yes
35	GET /iolink/v1/devices/{deviceAlias}/events	Read event log from the specified device	Yes
36	GET /iolink/v1/mqtt/configuration	Read configuration of MQTT clients	Yes

No.	REST API URL	Description	Supporting
37	POST /iolink/v1/mqtt/configuration	Write configuration of MQTT clients	-
38	GET /iolink/v1/mqtt/topics	Read list of MQTT topics	-
39	POST /iolink/v1/mqtt/topics	Write list of MQTT topics	-
40	DELETE /iolink/v1/mqtt/topics/{topicID}	Delete a specific MQTT topic	-
41	GET /iolink/v1/mqtt/topics/{topicID}	Read a specific MQTT topic	-
42	GET /iolink/v1/mqtt/connectionstatus	Read connection status	Yes

Vendor-specific JSON settings

No.	REST API URL	Description	Supporting
43	GET /iolink/v1/vendor/masters/\$MASTER_NUMBER/diagnostics/configuration	Diagnostic configuration of the master	Yes
44	GET /iolink/v1/vendor/masters/\$MASTER_NUMBER/diagnostics/value	Diagnostic values of the master	Yes
45	GET /iolink/v1/vendor/masters/\$MASTER_NUMBER/ports/\$PORT_NUMBER/statistics/current	Current statistic values of the specified port of the master	Yes
46	GET /iolink/v1/vendor/masters/\$MASTER_NUMBER/ports/\$PORT_NUMBER/statistics/voltage	Voltage statistic values of the specified port of the master	Yes
47	GET /iolink/v1/vendor/masters/\$MASTER_NUMBER/ports/\$PORT_NUMBER/statistics/temperature	Temperature statistic values of the specified port of the master	Yes
48	GET /iolink/v1/vendor/masters/1/ports/1/statistics/stack	IO-Link stack statistic values of the specified port of the master	-
49	GET /iolink/v1/vendor/masters/\$MASTER_NUMBER/ports/\$PORT_NUMBER/diagnostics/configuration	Diagnostic configuration of the specified port of the master	Yes
50	GET /iolink/v1/vendor/masters/\$MASTER_NUMBER/ports/\$PORT_NUMBER/diagnostics/current	Diagnostic current value of the specified port of the master	Yes
51	GET /iolink/v1/vendor/masters/\$MASTER_NUMBER/ports/\$PORT_NUMBER/diagnostics/voltage	Diagnostic voltage value of the specified port of the master	Yes

No.	REST API URL	Description	Supporting
52	GET /iolink/v1/vendor/masters/ \$MASTER_NUMBER/ports/ \$PORT_NUMBER/diagnostics/tem- perature	Diagnostic temperature value of the speci- fied port of the master	Yes

9.10.2 MQTT



INFO

If MQTT is enabled, mandatory that JSON is activated as well.

MQTT settings

No.	MQTT topics	Description
1	\$MQTT_CLIENT_HEAD_TOPIC /iolink/v1/ gateway/ identification	Identification of the gateway
2	\$MQTT_CLIENT_HEAD_TOPIC /iolink/v1/ gateway/ capabilities	Capabilities of the gateway
3	\$MQTT_CLIENT_HEAD_TOPIC /iolink/v1/ gateway/ configuration	Network configuration of the gateway
4	\$MQTT_CLIENT_HEAD_TOPIC /iolink/v1/ masters	Get all available master number keys and identification information
5	\$MQTT_CLIENT_HEAD_TOPIC /iolink/v1/ masters/\$MASTER_NUMBER/diagnostics/ value	Diagnostic values of the master
6	\$MQTT_CLIENT_HEAD_TOPIC /iolink/v1/ masters/\$MASTER_NUMBER/diagnostics/ configuration	Diagnostic configuration of the master
7	\$MQTT_CLIENT_HEAD_TOPIC /iolink/v1/ masters/\$MASTER_NUMBER/capabilities	Capabilities of the master
8	\$MQTT_CLIENT_HEAD_TOPIC /iolink/v1/ masters/\$MASTER_NUMBER/identification	Identification of the master
9	\$MQTT_CLIENT_HEAD_TOPIC /iolink/v1/ masters/\$MASTER_NUMBER/ports	Get all available port number keys
10	\$MQTT_CLIENT_HEAD_TOPIC /iolink/v1/ masters/\$MASTER_NUMBER/ports/ \$PORT_NUMBER/capabilities	Read capability information of the speci- fied port
11	\$MQTT_CLIENT_HEAD_TOPIC /iolink/v1/ masters/\$MASTER_NUMBER/ports/ \$PORT_NUMBER/status	Read actual status of the specified port
12	\$MQTT_CLIENT_HEAD_TOPIC /iolink/v1/ masters/\$MASTER_NUMBER/ports/ \$PORT_NUMBER/configuration	Read/Write configuration of the specified port
13	\$MQTT_CLIENT_HEAD_TOPIC /iolink/v1/ masters/\$MASTER_NUMBER/ports/ \$PORT_NUMBER/diagnostics/ configuration	Diagnostic configuration of the specified port of the master

No.	MQTT topics	Description
14	\$MQTT_CLIENT_HEAD_TOPIC /iolink/v1/masters/\$MASTER_NUMBER/ports/\$PORT_NUMBER/diagnostics/ current	Diagnostic current value of the specified port of the master
15	\$MQTT_CLIENT_HEAD_TOPIC /iolink/v1/masters/\$MASTER_NUMBER/ports/\$PORT_NUMBER/diagnostics/ voltage	Diagnostic voltage value of the specified port of the master
16	\$MQTT_CLIENT_HEAD_TOPIC /iolink/v1/masters/\$MASTER_NUMBER/ports/\$PORT_NUMBER/diagnostics/ temperature	Diagnostic temperature value of the specified port of the master
17	\$MQTT_CLIENT_HEAD_TOPIC /iolink/v1/masters/\$MASTER_NUMBER/ports/\$PORT_NUMBER/statistics/ current	Current statistic values of the specified port of the master
18	\$MQTT_CLIENT_HEAD_TOPIC /iolink/v1/masters/\$MASTER_NUMBER/ports/\$PORT_NUMBER/statistics/ voltage	Voltage statistic values of the specified port of the master
19	\$MQTT_CLIENT_HEAD_TOPIC /iolink/v1/masters/\$MASTER_NUMBER/ports/\$PORT_NUMBER/statistics/ temperature	Temperature statistic values of the specified port of the master
20	\$MQTT_CLIENT_HEAD_TOPIC /iolink/v1/devices/\$DEVICE_ALIAS/processdata/value	Read/Write process data value from/to the specified device
21	\$MQTT_CLIENT_HEAD_TOPIC /iolink/v1/devices/\$DEVICE_ALIAS/processdata/getdata/value	Read process data input value from the specified device
22	\$MQTT_CLIENT_HEAD_TOPIC /iolink/v1/devices/\$DEVICE_ALIAS/processdata/setdata/value	Read process data output value from the specified device
23	\$MQTT_CLIENT_HEAD_TOPIC /iolink/v1/devices/\$DEVICE_ALIAS/events	Read event log from the specified device
24	\$MQTT_CLIENT_HEAD_TOPIC /Asset	Information about the publisher (network, vendor, firmware)
25	\$MQTT_CLIENT_HEAD_TOPIC /Online	Status of the publisher (online when connected)

9.10.3 OPC UA



INFO

The devices shown in the screenshots serve as examples.

The device features OPC UA server. The OPC UA client can establish a connection to the device for access to the following parameters:

- Device identification,
- configuration parameters,
- process data,
- measured values,
- diagnostic information,
- statistical information, etc.

The OPC UA client establishes connection using the following URL:

opc.tcp://IP-Adresse:4840



INFO

The IP address of the device is used for **IP address** .

9.10.3.1 OPC UA PC Client

The device integrates OPC UA server. The OPC UA client is for device communication.

For test purposes, you can use *UaExpert* from *Unified Automation GmbH*, for example: <https://www.unifiedautomation.com>.

The OPC UA client has read access to the device using the authentication “Anonymous”. The OPC UA client has read and write access to the device using the authentication “User name and Password”, provided the related user has write rights.

Conneting to CM50I.PN

Condition:

- ⇒ You have OPC UA client.
- ⇒ For write access to the device, you need to know user name, password and have write access.
- ⇒ You know the device IP address.

Instruction:

- a) Start *UaExpert*.
- b) Create a new project via **File > New**.
- c) Add new server by selecting **Server r > Add**.

Result:

- ✓ Dialog window **Add Server** is shown in tab **Discovery**.

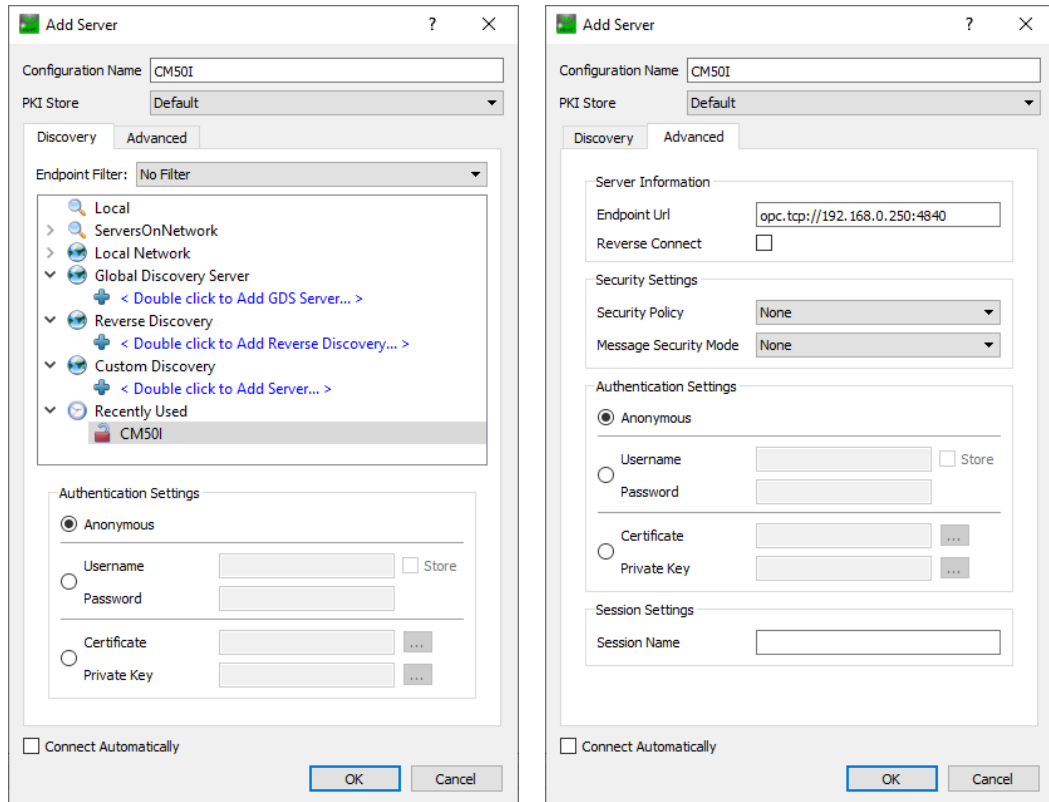

III. 66: Dialog window Add Server – tabs Discovery and Advanced

- a) In field **Configuration Name** enter a name for the configuration, e.g. Test.
- b) Select tab **Advanced**.
- c) In the **Server Information** area of the **Advanced** tab, enter the following in the **Endpoint Url** data field:
`opc.tcp://<IP address>:4840`
 Enter the IP address of the device for <IP address>.
- d) In the **Authentication Settings** area, select the option **Username/ Password** if you want write access to the device or **Anonymous** if read access is sufficient.
- e) If you have selected option **Username/Password**, enter your user name and your password.
- f) Click **OK**.
 - ✓ In the project window, *UaExpert* enters the server under **Project > Servers** with the selected name.
- g) Open server context menu (`Test` in the example) and select **Connect**.

Result:

- ✓ The connection is being established.

Client can access device parameters anonymously (read only) or with user name/password (read and write). User name and password are entered via web server.

The following figure shows an excerpt of the device information model.

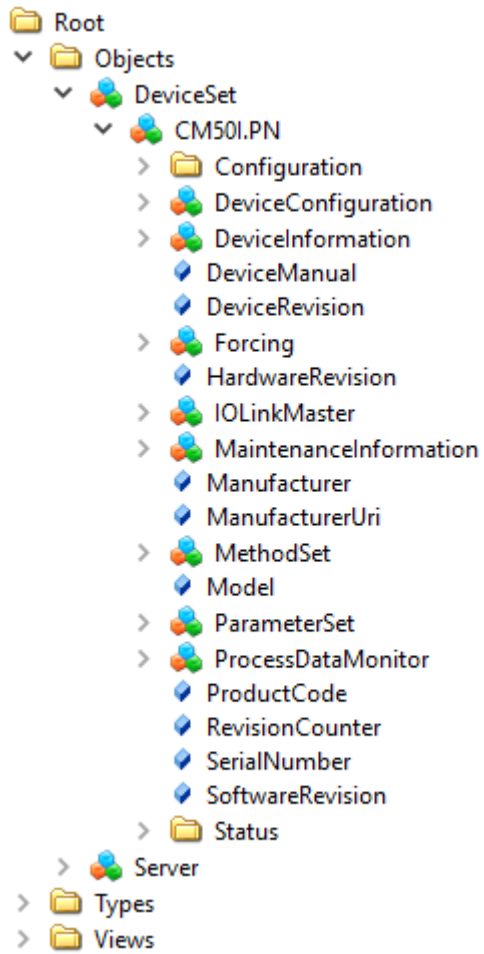

III. 67: OPC-UA-Server - Device information model

The following figure shows an excerpt of an IO-Link port information model.

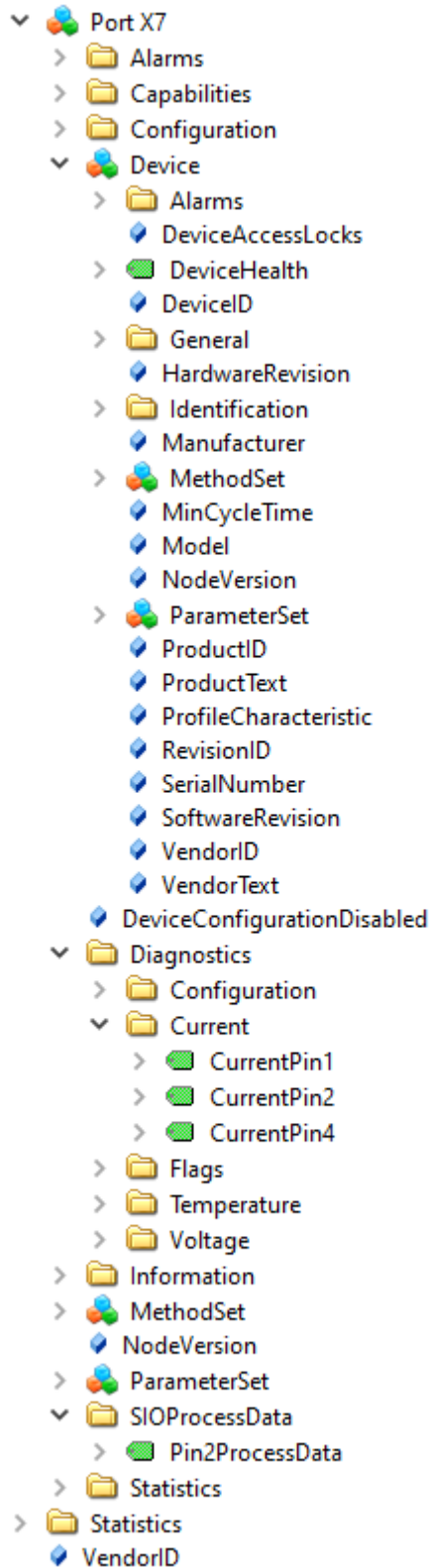

III. 68: OPC-UA-Server - Port information model

9.10.3.2 Authentication

User log on

OPC UA use the same users and passwords as those documented in the web server description.

OPC UA server connection is established via user **guest** allowing read access to the OPC UA objects.

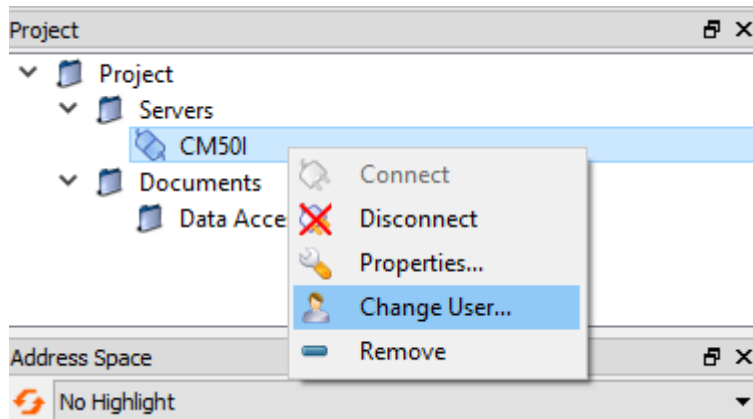

III. 69: Changing the user

For further actions, another user must be selected.

Instruction:

- a) User name **<admin>**
- b) Password **<private>**

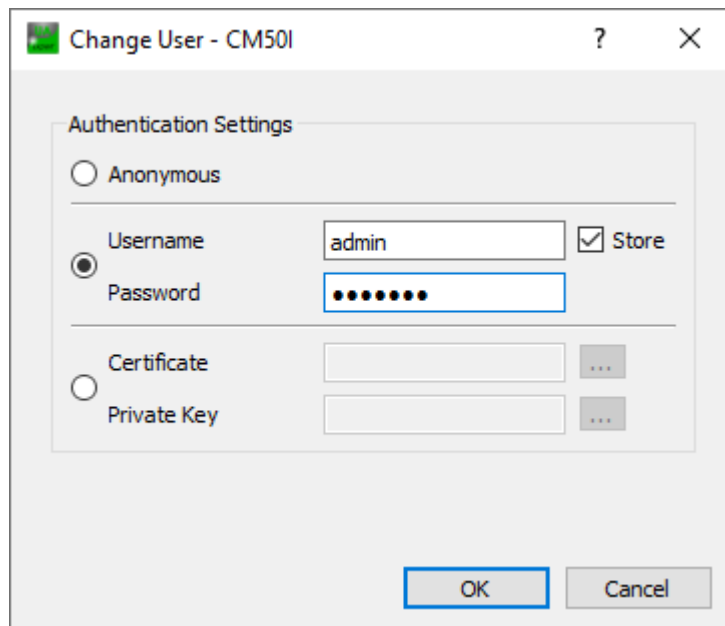

III. 70: User name and password

Forcing

Digital outputs enable manual switching via OPC UA(Forcing).

Step 1

Create an ID from the device using the *GetForcingID* method.

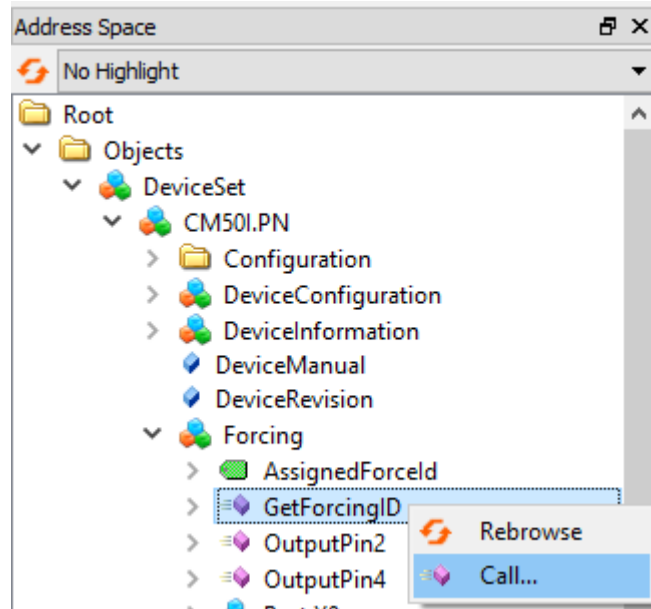

Ill. 71: Accessing *GetForcingID*-Methode

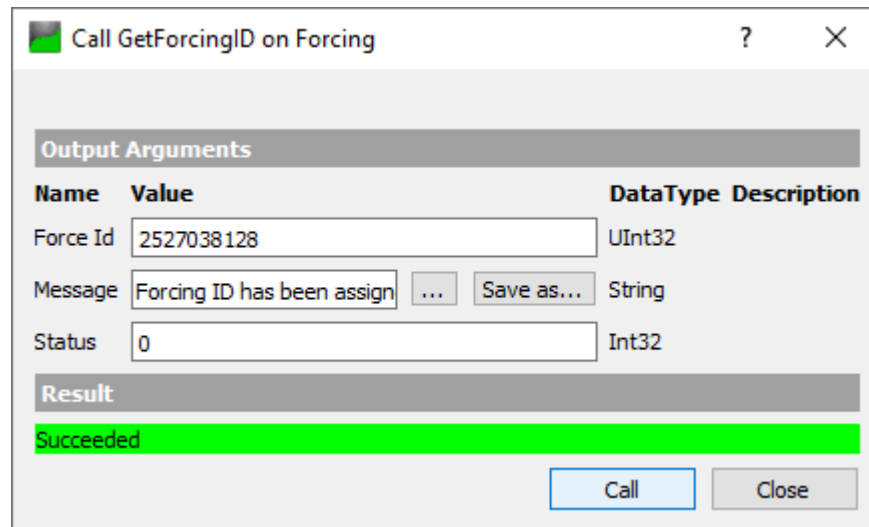

Ill. 72: Dialog window of the *GetForcingID* method



INFO

ForcingID is only valid for 10 seconds. Every access to *Forcing* will refresh validity to another 10 seconds.

Step 2

Set the digital outputs using methods *OutputPin2* respectively *OutputPin4*.

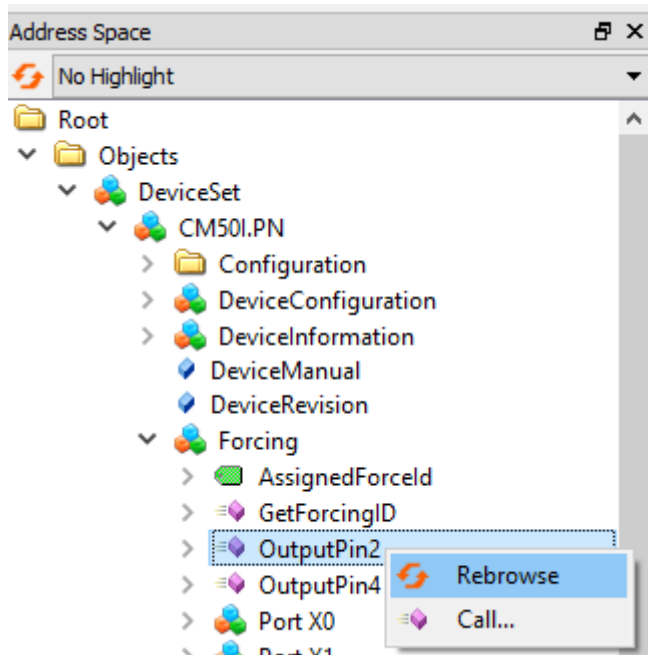

III. 73: Accessing method *OutputPin2*

This method expects as parameters the included *Forcing ID*, a bit mask and the data to be written.

9.10.3.3**Device identification**

The device provides nodes for device identification. From this node, the *OPC UA* client for example will read the applied device firmware revision.

Node ID	Node class	Access	Description
Manufacturer	Variable	read	Device manufacturer
ManufacturerUri	Variable	read	Device manufacturer URL
Model	Variable	read	Device model designation
ProductCode	Variable	read	Device product code
RevisionCounter	Variable	read	Device Hardware Revision
SerialNumber	Variable	read	Device serial number
SoftwareRevision	Variable	read	Device firmware revision

Tab. 27: Device identification

#	Server	Node Id	Display Name	Value	Datatype
1	CM50I	NS6 Numeric 161	Manufacturer	"en", "Baumer"	LocalizedText
2	CM50I	NS6 Numeric 166	ManufacturerUri	www.baumer.com	String
3	CM50I	NS6 Numeric 162	Model	"en", "CM50I.PN"	LocalizedText
4	CM50I	NS6 Numeric 167	ProductCode	11261571	String
5	CM50I	NS6 Numeric 163	RevisionCounter	1	Int32
6	CM50I	NS6 Numeric 164	SerialNumber	6040000002979658	String
7	CM50I	NS6 Numeric 165	SoftwareRevision	V1.3.0	String

Ill. 74: Device identification

9.10.3.4 Configuration parameters

The *OPC UA* server provides nodes with device configuration parameters. For example, in node **OverTemperature** the *OPC UA* client can read out the maximum temperature limit.

Node ID	Node class	Access	Default	Description
CurrentHysteresis	Variable	read	10 mA	Current hysteresis, unit: mA If the limit is exceeded by current, current must first drop below again by the hysteresis value to cancel diagnostics.
OverTemperature	Variable	read	70 °C	Maximum limit for port temperature, unit: 0.1 °C
OverVoltageL	Variable	read	30 V	Maximum power limit assigned to supply line 1 enabling monitoring of pins L+, DI, DO, DIO, IO-Link. Unit: mV
OverVoltageL2	Variable	read	30 V	Maximum power limit assigned to supply line 2, unit: mV
TemperatureHysteresis	Variable	read	2 °C	Temperature hysteresis, unit: 0.1 °C If the limit is exceeded by temperature, temperature must first drop below again by the hysteresis value to cancel diagnostics.
UnderTemperature	Variable	read	-25 °C	Minimum limit for port temperature, unit: 0.1°C°

Node ID	Node class	Access	Default	Description
UnderVoltage L	Variable	read	18 V	Minimum power limit assigned to supply line 1 enabling monitoring of pins L+, DI, DO, DIO, IO-Link. Unit: mV
UnderVoltage L2	Variable	read	18 V	Minimum power limit assigned to supply line 2, unit: mV
Voltage Hysteresis	Variable	read	300 mV	Voltage hysteresis, unit: mV If the limit is exceeded by voltage, voltage must first drop below again by the hysteresis value to cancel diagnostics.

Tab. 28: Device specific configuration parameters

#	Server	Node Id	Display Name	Value	Datatype
1	CM50I	NS6 Numeric 2057	CurrentHysteresis	10	UInt16
2	CM50I	NS6 Numeric 2050	OverTemperature	70	Float
3	CM50I	NS6 Numeric 2058	OverVoltageL	30000	Int32
4	CM50I	NS6 Numeric 2059	OverVoltageL2	30000	Int32
5	CM50I	NS6 Numeric 2051	TemperatureHyster...	2	Float
6	CM50I	NS6 Numeric 2049	UnderTemperature	-25	Float
7	CM50I	NS6 Numeric 2060	UnderVoltageL	17000	Int32
8	CM50I	NS6 Numeric 2061	UnderVoltageL2	17000	Int32
9	CM50I	NS6 Numeric 2062	VoltageHysteresis	300	UInt16

III. 75: Device specific configuration parameters

Node ID	Node class	Access	Default	Description
OverCurrentPin1, OverCurrentPin2, OverCurrentPin4	Variable	read	0	Warning level for maximum current limit at pin 1, pin 2 or pin 4, unit: 1mA

Node ID	Node class	Access	Default	Description
UnderCurrent-Pin1, UnderCurrent-Pin2, UnderCurrentPin4	Variable	read	0	Warning level for minimum current limit at pin 1, pin 2 or pin 4, unit: 1mA 0: monitoring not enabled

Tab. 29: Port-specific configuration parameters

#	Server	Node Id	Display Name	Value	Datatype
1	CM50I	NS6 Numeric 34860	OverCurrentPin1	0	Int32
2	CM50I	NS6 Numeric 34862	OverCurrentPin2	0	Int32
3	CM50I	NS6 Numeric 34864	OverCurrentPin4	0	Int32
4	CM50I	NS6 Numeric 34861	UnderCurrentPin1	0	Int32
5	CM50I	NS6 Numeric 34863	UnderCurrentPin2	0	Int32
6	CM50I	NS6 Numeric 34865	UnderCurrentPin4	0	Int32

III. 76: Port-specific configuration parameters

9.10.3.5 Process data

The *OPC UA* server provides nodes including process data. For example, in node **Pin2ProcessData** the *OPC UA* client can read out a port value provided at pin 2.

Node ID	Node class	Access	Description
Pin2ProcessData	Variable	read	Process data at pin 2
Pin4ProcessData	Variable	read	Process data at pin 4

Tab. 30: Process data

#	Server	Node Id	Display Name	Value
1	CM50I	NS6 Numeric 33340	Pin2ProcessData	false
2	CM50I	NS6 Numeric 33341	Pin4ProcessData	false

III. 77: Process data

9.10.3.6 Measured values

The *OPC UA* server provides nodes with calculated measured values. For example, in node **SumCurrentL** the *OPC UA* client can read in calculated total current of supply line 1.

Node ID	Node class	Access	Description
SumCurrentL	Variable	read	The total current calculated from individual measurements in supply line 1, unit: mA
SumCurrentL2	Variable	read	The total current calculated from individual measurements in supply line 2, unit: mA
MeanTemperature	Variable	read	Average temperature value assigned to the component, calculated from each temperature value individually measured at the three chips. Unit: °C
MeanVoltageL	Variable	read	Average voltage in supply line 1, unit: mV
MeanVoltageL2	Variable	read	Average voltage in supply line 2, unit: mV

Tab. 31: Device-specific (calculated) measured values

#	Server	Node Id	Display Name	Value	Datatype
1	CM50I	NS6 Numeric 2052	SumCurrentL	114	Int32
2	CM50I	NS6 Numeric 2053	SumCurrentL2	0	Int32
3	CM50I	NS6 Numeric 2054	MeanTemperature	34.6	Float
4	CM50I	NS6 Numeric 2055	MeanVoltageL	24037	Int32
5	CM50I	NS6 Numeric 2056	MeanVoltageL2	24180	Int32

III. 78: Device-specific (calculated) measured values

Node ID	Node class	Access	Description
CurrentPin1, CurrentPin2, CurrentPin4	Variable	read	Current measured at pin 1, pin 2 or pin 4, unit: mA
TemperaturePin1, TemperaturePin2, TemperaturePin4	Variable	read	Temperature measured at pin 1, pin 2 or pin 4, unit: °C
VoltagePin1, VoltagePin2, VoltagePin4	Variable	read	Voltage measured at pin 1, pin 2 or pin 4, unit: mA

Tab. 32: Port specific measuring values

#	Server	Node Id	Display Name	Value	Datatype
1	CM50I	NS6 Numeric 34836	CurrentPin1	31	Int32
2	CM50I	NS6 Numeric 34837	CurrentPin2	0	Int32
3	CM50I	NS6 Numeric 34838	CurrentPin4	0	Int32
4	CM50I	NS6 Numeric 34854	MaxTemperaturePin1	36.7	Float
5	CM50I	NS6 Numeric 34855	MaxTemperaturePin2	36.7	Float
6	CM50I	NS6 Numeric 34856	MaxTemperaturePin4	36.7	Float
7	CM50I	NS6 Numeric 34851	MinVoltagePin1	24022	Int32
8	CM50I	NS6 Numeric 34852	MinVoltagePin2	-162	Int32
9	CM50I	NS6 Numeric 34853	MinVoltagePin4	-153	Int32

III. 79: Port specific measuring values

9.10.3.7 Diagnostic tools

The *OPC UA* server provides nodes with diagnostic information. In node **DiagnosticsPin1**, the *OPC UA* client can read whether the device has identified presence of any over current at pin 1 of a port.

Node ID	Node class	Access	Description
DiagnosticsPin1, DiagnosticsPin2, DiagnosticsPin4	Variable	read	Diagnostics on pin 1, pin 2 or pin 4. The numerical value contains bit-coded information: <ul style="list-style-type: none"> ■ Bit 0: Short circuit, ■ Bit 1: Overload protection, ■ Bit 2: Overtemperature protection, ■ Bit 3: Overvoltage protection, ■ Bit 4: Overcurrent, ■ Bit 5: Undercurrent ■ Bit 0: Overtemperature ■ Bit 1: Undertemperature ■ Bit 2: Overvoltage ■ Bit 3: Undervoltage

Node ID	Node class	Access	Description
			<ul style="list-style-type: none"> Bit 4: Watchdog 0: Diagnosis not active 1: Diagnosis active

Tab. 33: Port-specific diagnostics

#	Server	Node Id	Display Name	Value	Datatype
1	CM50I	NS6 Numeric 34839	DiagnosticsPin1	0	Int32
2	CM50I	NS6 Numeric 34840	DiagnosticsPin2	0	Int32
3	CM50I	NS6 Numeric 34841	DiagnosticsPin4	0	Int32

III. 80: Port-specific diagnostics

9.10.3.8 Statistics

The OPC UA server provides nodes with statistical information. In node **MaxCurrentPin1**, the OPC UA client can read at pin 1 of a port the maximum measured current.

Node ID	Node class	Access	Description
Current			
MaxCurrentPin1, MaxCurrentPin2, MaxCurrentPin4	Variable	read	Maximum current at pin 1, pin 2 or pin 4 since value reset, unit: mA
MinCurrentPin1, MinCurrentPin2, MinCurrentPin4	Variable	read	Minimum current at pin 1, pin 2 or pin 4 since value reset, unit: mA
Temperature			
MaxTemperaturePin1, MaxTemperaturePin2, MaxTemperaturePin4	Variable	read	Maximum temperature at pin 1, pin 2 or pin 4 since value reset, unit: °C

Node ID	Node class	Access	Description
MinTemperaturePin1, MinTemperaturePin2, MinTemperaturePin4	Variable	read	Minimum temperature at pin 1, pin 2 or pin 4 since value reset, unit: °C
Voltage			
MaxVoltagePin1, MaxVoltagePin2, MaxVoltagePin4	Variable	read	Maximum voltage at pin 1, pin 2 or pin 4 since value reset, unit: mV
MinVoltagePin1, MinVoltagePin2, MinVoltagePin4	Variable	read	Minimum voltage at pin 1, pin 2 or pin 4 since value reset, unit: mV

Tab. 34: Port specific statistical information

#	Server	Node Id	Display Name	Value	Datatype
1	CM50I	NS6 Numeric 34842	MaxCurrentPin1	38	Int32
2	CM50I	NS6 Numeric 34843	MaxCurrentPin2	10	Int32
3	CM50I	NS6 Numeric 34844	MaxCurrentPin4	0	Int32
4	CM50I	NS6 Numeric 34845	MinCurrentPin1	9	Int32
5	CM50I	NS6 Numeric 34846	MinCurrentPin2	0	Int32
6	CM50I	NS6 Numeric 34847	MinCurrentPin4	0	Int32
7	CM50I	NS6 Numeric 34854	MaxTemperaturePin1	36.7	Float
8	CM50I	NS6 Numeric 34855	MaxTemperaturePin2	36.7	Float
9	CM50I	NS6 Numeric 34856	MaxTemperaturePin4	36.7	Float
10	CM50I	NS6 Numeric 34857	MinTemperaturePin1	28.8	Float
11	CM50I	NS6 Numeric 34858	MinTemperaturePin2	28.8	Float
12	CM50I	NS6 Numeric 34859	MinTemperaturePin4	28.8	Float
13	CM50I	NS6 Numeric 34848	MaxVoltagePin1	24068	Int32
14	CM50I	NS6 Numeric 34849	MaxVoltagePin2	23545	Int32
15	CM50I	NS6 Numeric 34850	MaxVoltagePin4	23111	Int32
16	CM50I	NS6 Numeric 34851	MinVoltagePin1	24022	Int32
17	CM50I	NS6 Numeric 34852	MinVoltagePin2	-162	Int32
18	CM50I	NS6 Numeric 34853	MinVoltagePin4	-153	Int32

III. 81: Port specific statistical information

9.10.3.9 NTP client configuration

The *OPC UA* server provides nodes for NTP client configuration.

Node ID	Node class	Access	Description
NtpClientServerIpAddress	Variable	Read / Write	<ul style="list-style-type: none"> NTP server IP address The NTP client uses the set IP address for retrieving the time information from the NTP server. The IP address must be converted into a decimal number. The table shows how to convert. Value 0 disables the function.
NtpClientServerIpAddressFallback	Variable	Read / Write	<ul style="list-style-type: none"> IP address of the NTP server (fallback) The optional IP address if the NTP server is not accessible via the IP address in node NtpClientServerIpAddress. The IP address must be converted into a decimal number. The table shows how to convert. Value 0 disables the function.
NtpClientUpdateConfiguration	Variable	Write	Method for writing the nodes NtpClientServerIpAddress and NtpClientServerIpAddressFallback

Tab. 35: NTP client configuration

The following formula is used to convert the IP address into a decimal number. Starting from an IP address in the format **A.B.C.D**:

$$((A * 256 + B) * 256 + C) * 256 + D = \text{IP address converted into a decimal number}$$

Example: IP address 192.53.103.108:

$$((192 * 256 + 53) * 256 + 103) * 256 + 108 = 3224725356$$

NTP server example

NTP-Server `ptbtime1.ptb.de` of the German National Metrology Institute in Braunschweig with the IP address `192.53.103.108`

Replacement NTP server (optional) is NTP server `ptbtime2.ptb.de` of the Physikalisch-Technische Bundesanstalt in Braunschweig with IP address `192.53.103.104`

Condition:

- ⇒ You have OPC UA client.
- ⇒ You know user name and password and have write access.
- ⇒ You know the IP Address of an NTP Server.
- ⇒ You have converted the IP address of this NTP server into a decimal number, as described in chapter "NTP Client Configuration".
- ⇒ Connection to the MVK device has already been established.

Instruction:

- a) In window **Address Space** pen context menu: Root > Objects > **DeviceSet** > [**device name**] > **Configuration** > **NtpClient** > **NtpClientUpdateConfiguration**.

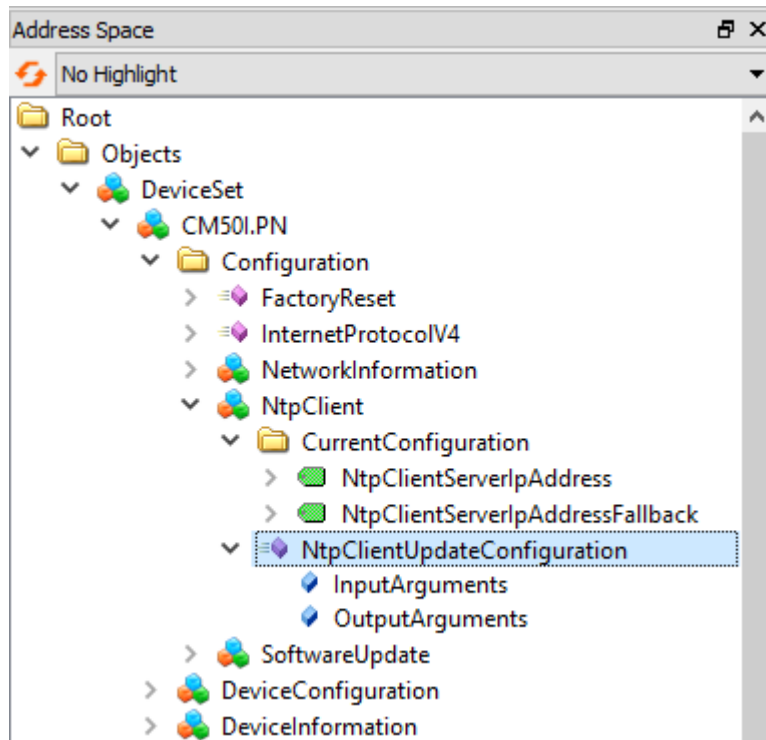

///. 82: NTP client update configuration

- b) In the context menu, select **Call**.

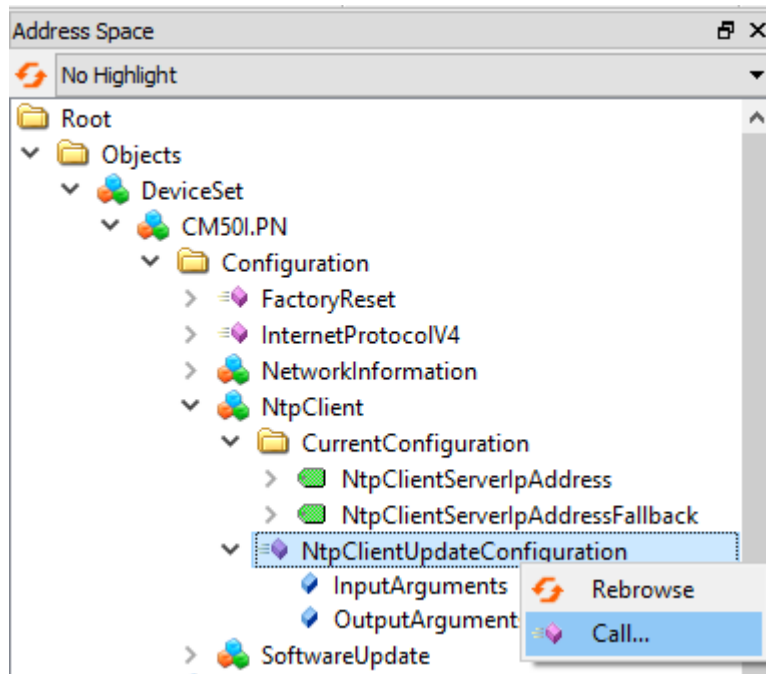

///. 83: NTP client configuration

- ✓ Dialog window **Call NtpClientUpdateConfiguration on NtpClient** pops up:

Input Arguments			
Name	Value	Data Type	Description
ServerIpAddress	3224725356	UInt32	
ServerIpAddressFallback	3224725356	UInt32	

Output Arguments			
Name	Value	Data Type	Description
Status	<input type="text"/>	Int32	

Result			
--------	--	--	--

Call Close

///. 84: Dialog window for NTP client configuration

- In the **Input Arguments** area, enter the value 3224725356 in the input field **ServerIpAddress** for the IP address of the NTP server.
- In the **Input Arguments** area, enter 3224725352 in the **ServerIpAddressFallback** input field for the IP address of the replacement NTP server.
- Click **Call**.

If the function call was successful, the output field to the right of the status in the **Output Arguments** area displays the value 0 . A green bar with the text *Succeeded* is displayed in the **Result** area.

Both variables *ServerIpAddress* and *ServerIpAddressFallback* are now set. The device receives the current time from the time server via NTP and synchronizes its internal time.

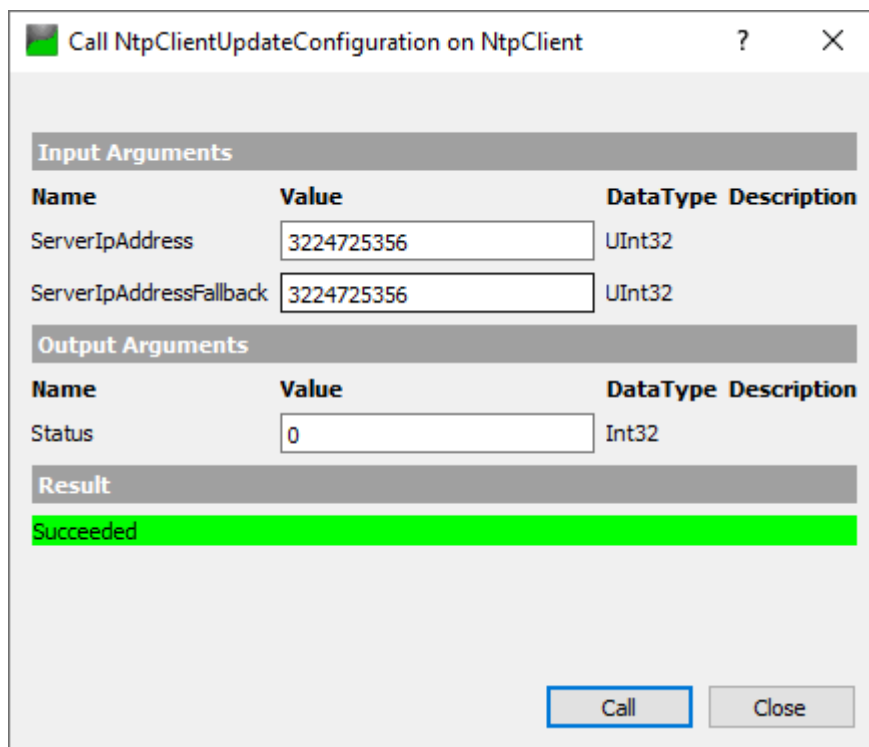

III. 85: Dialog window for NTP client configuration (successful)

10 Operation

10.1 LED indicator

The device provides clearly arranged indicators:

- LED indicator inputs / outputs
- LED indicator BUS
- LED indicator POWER
- Advanced LED indicator

The front LED indicators are correspondingly marked for clear assignment. Either indicated by continuous or flashing LEDs.

10.1.1 LED assignment to channel and pin

Each input and output is assigned an individual status indicator.

- LED channel 0X (X= port number) is assigned to **pin 4** .
- LED channel 1X (X= port number) is assigned to **pin 2** .

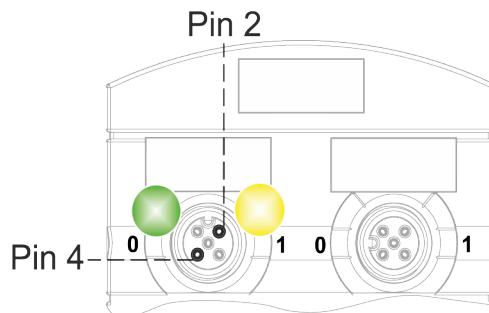

10.1.2 LED flashing behavior

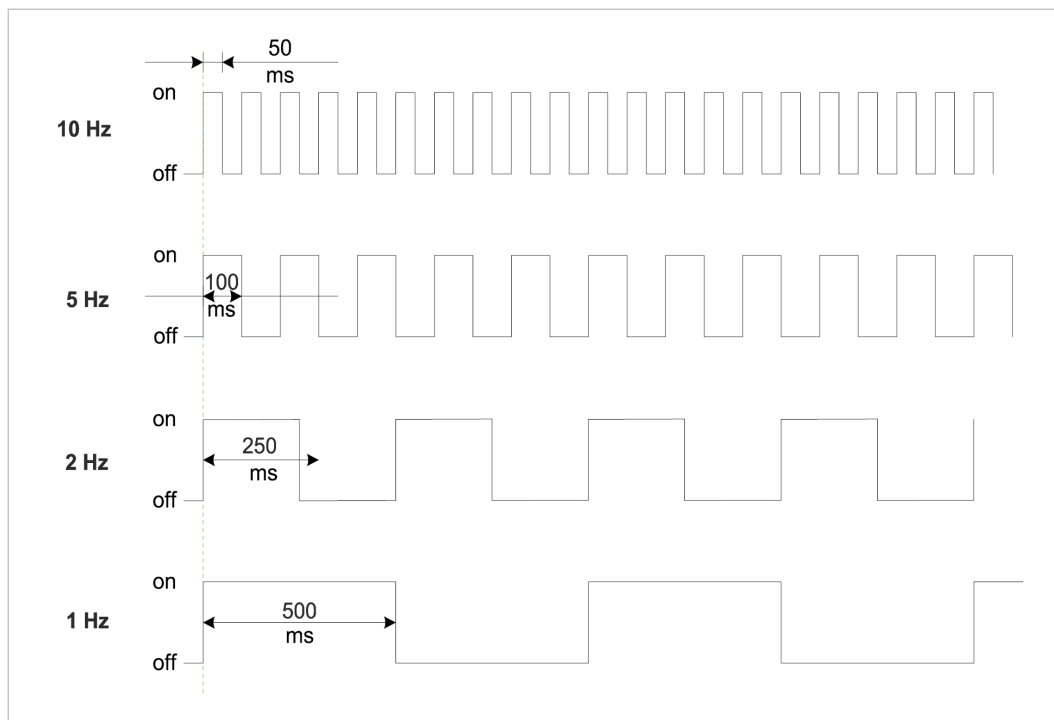



///. 86: LED flashing behavior

10.1.3 LED indicator for inputs and outputs







Each input and output is assigned an individual status indicator.

Pin 2 digital input DI

Indicator	Status	Description
 Yellow	On continuous	Permanent configuration: DI (NO) visible in process data. 24 V
 Red	Flashing at 1 Hz	Overload/short circuit in sensor supply 24 V + Pin1
 Off	Off	Pin 2 is not assigned or disabled

Tab. 36: LED indicator DI pin 2

PIN 2 digital output DO



Indicator	Status	Description
 Yellow	On continuous	Permanent configuration: DO switchable by process data 24 V
 Red	On continuous	Overload / short circuit at pin 2
 Red	Flashing at 1 Hz	Overload/short circuit in sensor supply 24 V + Pin1
 Off	Off	Pin 2 is not assigned or disabled

Tab. 37: LED indicator DO pin 2

Error at the input or output





In the event of error present at one of the inputs or outputs, the related LED at the M12 port will light up red.

Pin 4 digital input DI

Indicator	Status	Description
 Yellow	On continuous	Permanent configuration: DI (NO) visible in process data 24 V
 Red	Flashing at 1 Hz	Overload/short circuit in sensor supply 24 V + Pin1
 Off	Off	Pin 4 is not assigned or disabled







Tab. 38: LED indicator DI pin 4

PIN 4 digital output DO

Indicator	Status	Description
 Yellow	On continuous	Permanent configuration: DO switchable by process data 24 V
 Red	On continuous	Overload / short circuit at pin 4
 Red	Flashing at 1 Hz	Overload/short circuit in sensor supply 24 V + Pin1
 Grey	Off	Pin 4 is not assigned or disabled

Tab. 39: LED indicator DO pin 4

Pin 4 IO-Link mode

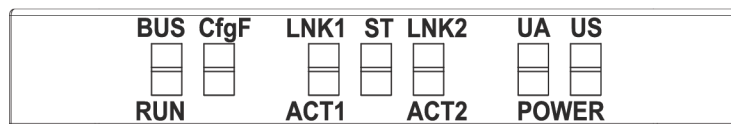

Indicator	Status	Description
 Green	On continuous	IO-Link in status <i>Operate</i> .
 Green	Flashing at 1 Hz	<ul style="list-style-type: none"> Device is not connected No communication with connected device.
 Green	Flashing at 10 Hz	<ul style="list-style-type: none"> IO-Link in status <i>Pre-Operate</i> during data storage Validation failed. Connected IO-Link not compatible.
 Red	On continuous	Overload / short circuit at pin 4
 Red	Flashing at 2 Hz	<ul style="list-style-type: none"> Validation failed. Connected IO-Link device for data storage is not compatible. Data storage failed.
 Grey	Off	IO-Link connection deactivated.

Tab. 40: LED indicator IO-Link mode Pin 4

10.1.4**BUS RUN- and CfgF LED**

- **BUS RUN** indicates the bus status.
- **CfgF** shows PLC configuration status.



LED indicator BUS_RUN

Indicator	Status	Description
 Red	On continuous	No configuration, no connection present
 Red	Flashing at 2 Hz	No data transfer

Indicator	Status	Description
	Off	Error-free operation

Tab. 41: LED indicator BUS_RUN

LED indicator CfgF

Indicator	Status	Description
 Red	On continuous	<ul style="list-style-type: none"> Channel, generic or advanced diagnostics available Watchdog-Timeout System error
 Red	Flashing at 1 Hz 3 s	DCP signal service initiated via bus
	Off	Error-free operation

Tab. 42: LED indicator CfgF

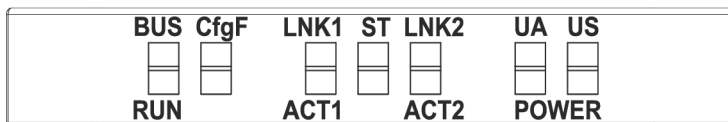

10.1.5

LED indicator LNK/ACT





- LNK/ACT LNK/ACT (Link/Activity) indicates the status of EtherCAT communication at each port.

LED indication LNK/ACT

LED indicator	LED status	Description
 Green	On continuous	Connection to network present.
	Off	No connection to network.

Tab. 43: LED indication LNK/ACT

LED indicator ACT

LED indicator	LED status	Description
 Yellow	Flashing	Device is transmitting / receiving Ethernet frames
	Off	The device is transmitting /receiving Ethernet frames

Tab. 44: LED indicator ACT

LED indicator off

This is what to do:

Instruction:



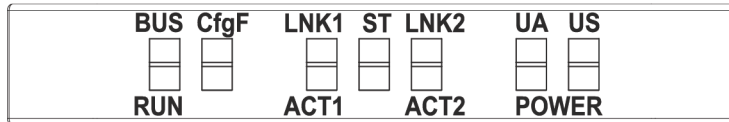

- ◆ Check the line connections.

10.1.6 LED status indicator



- ST indicates the overall device status.

LED indicator ST

Indicator	Status	Description
 Green	On continuous	Regular FW is running. Error-free operation.
 Green	Flashing at 4 Hz	The process requested by rotary switch position is being executed. Do not switch off device.
 Red	Flashing at 1 Hz	Invalid rotary switch position. System does not start.
 Red	On continuous	Initialization error. Error during device initialization. <ul style="list-style-type: none"> ▪ HW issues, ▪ no valid configuration, ▪ COM FW not found ▪ rotary switch operation failed, etc.

Tab. 45: LED indicator ST

LED indicator flashing red

This is what to do:

Instruction:

- Select a valid position.
- Restart device.

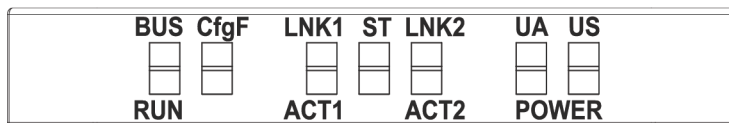

10.1.7 LED-Anzeige POWER US and UA





The power LEDs indicate the supply status

- **UA** actuator voltage
- **US** operating voltage





LED indicator POWER US

Indicator	Status	Description
 Green	On continuous	18 V ≤ US ≤ 30 V error-free operation
 Red	On continuous	11 V ≤ US ≤ 18 V undervoltage

Indicator	Status	Description
 Red	Flashing at 4 Hz	US >30 V overvoltage
	Off	US <11 V no voltage

Tab. 46: LED indicator POWER US

LED indicator POWER UA

Indicator	Status	Description
 Green	On continuous	18 V ≤ UA ≤30 V error-free operation
 Red	On continuous	11 V ≤ UA ≤18 V undervoltage
 Red	Flashing at 4 Hz	UA >30 V overvoltage
	Off	UA <11 V no voltage

Tab. 47: LED indicator POWER UA



INFO

Fault-free operation is no longer guaranteed at US <18 V.

10.1.8

Advanced LED indicator

h

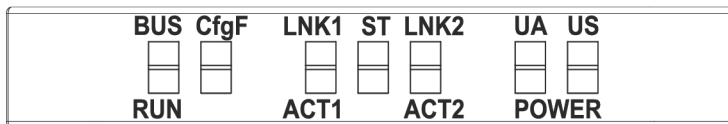

Device identification

LED	Indicator	Status	Description
CfgF	 Red	Flashing 3 times at 1 Hz	Device identification

Tab. 48: Advanced LED indicator, device identification

10.2

PROFINET Diagnostics

Alarm

CM50I transmits diagnostic information in the form of alarms based on *PROFINET* specification V2.3.

**INFO**

Diagnostics are signaled to the PLC in form of **inbound** or **outbound** alarms. For short-time alarms we recommend diagnostic buffer at the PLC. Such diagnostic buffer allows for later evaluation of alarm details. If the PLC does not feature a diagnostics buffer it should be provided in the form of application software.

10.2.1 Device-specific diagnostic messages

Channel Error Type	Description	Action
0x0100	Sensor undervoltage	Check the sensor supply voltage of the device.
0x0101	Sensor overvoltage	Check the sensor supply voltage of the device.
0x0102	Device overtemperature	Remove heat source.
0x0103	Sensor current overload	Check current consumption of connected load.
0x0104	Actuator current overload	Check current consumption of connected load.
0x0105	Device undertemperature	Insulate device.
0x0106	Actuator undervoltage	Check the device actuator supply.
0x0107	Actuator overvoltage	Check the device actuator supply.
0x0108	Force Mode Active	Deactivate Force mode via WebUI / OPC-UA / JSON.
0x0109	Short circuit pin 4	Check wiring to the mating connector.
0x010A	Short circuit pin 2	Check wiring to the mating connector.
0x010B	Short circuit pin 1	Check wiring to the mating connector.
0x010C	No actuator supply	Check the device actuator supply.
0x010D	No Connection to NTP Server	Check SNTP parameters and connection to NTP server.
0x010E	NTP Synchronisation lost	Check connection to NTP server.

Tab. 49: Device-specific diagnostic messages - error types, description and remedies

10.2.2 Diagnostic messages at IO-Link ports via IODD

Channel Error Type	Extended Channel Error Type	Description	Action
0x10 (16)	0x50E0 (20704)	IODD-on-Board: error in GSDML	Please contact <i>Baumer</i> .
0x10 (16)	0x50E0 (20704)	IODD-on-Board: general error	Please contact <i>Baumer</i> .
0x10 (16)	0x50E1 (20705)	IODD-on-Board: error in GSDML	Please contact <i>Baumer</i> .
0x10 (16)	0x50E2 (20706)	IODD-on-Board: error in GSDML	Please contact <i>Baumer</i> .
0x10 (16)	0x50E3 (20707)	IODD-on-Board: error in GSDML	Please contact <i>Baumer</i> .
0x10 (16)	0x50E4 (20708)	IODD-on-Board: error in GSDML	Please contact <i>Baumer</i> .

Channel Error Type	Extended Channel Error Type	Description	Action
0x10 (16)	0x50E5 (20709)	IODD-on-Board: invalid parameter value	Check device parameterization.
0x10 (16)	0x50E6 (20710)	IODD-on-Board: invalid parameter value	Check device parameterization.
0x10 (16)	0x50E7 (20711)	IODD-on-Board: invalid parameter value	Check device parameterization.

Tab. 50: Diagnostic messages at IO-Link ports via IODD – error types, meaning and action

10.2.3 Diagnostic messages at IO-Link ports

10.2.3.1 According to IO-Link integration guideline Edition 2

The listed diagnostics is available if the parameter for IO-Link event integration **Parameter 16** is set to **According to IO-Link integration guideline Edition 2**.

Channel Error Type	Extended Channel Error Type	IO-Link event code(s)	Description
0x9502	0x0000 – 0x7FFF	0x0000 – 0x7FFF	IO-Link master event. The <i>Extended Channel Error Type</i> corresponds to the original IO-Link event code.
0x9500	0x0000 – 0x7FFF	0x0000 – 0x7FFF	IO-Link device event. The <i>Extended Channel Error Type</i> corresponds to the original IO-Link event code.
0x9501	0x0000 – 0x7FFF	0x8000 – 0xFFF	IO-Link device event. The <i>Extended Channel Error Type</i> plus 0x8000 (32768) correspond to the original IO-Link event code.

Tab. 51: Diagnostic messages at IO-Link ports, according to IO-Link integration guideline Edition 2



INFO

The meaning of the IO-Link event codes can be found in the Profinet specification IO-Link Integration - Edition 2, Version 1.1 (IO-Link-Integration-for-PROFINET_Ed2_2832_V11_Feb20.pdf) or in the document IO-Link Interface and System, V1.1.3 (IOL-Interface-Spec_10002_V113_Jun19.pdf) of the IO-Link community.

11 Web server

The web server is a graphical tool with which you can obtain information about the device quickly and intuitively.

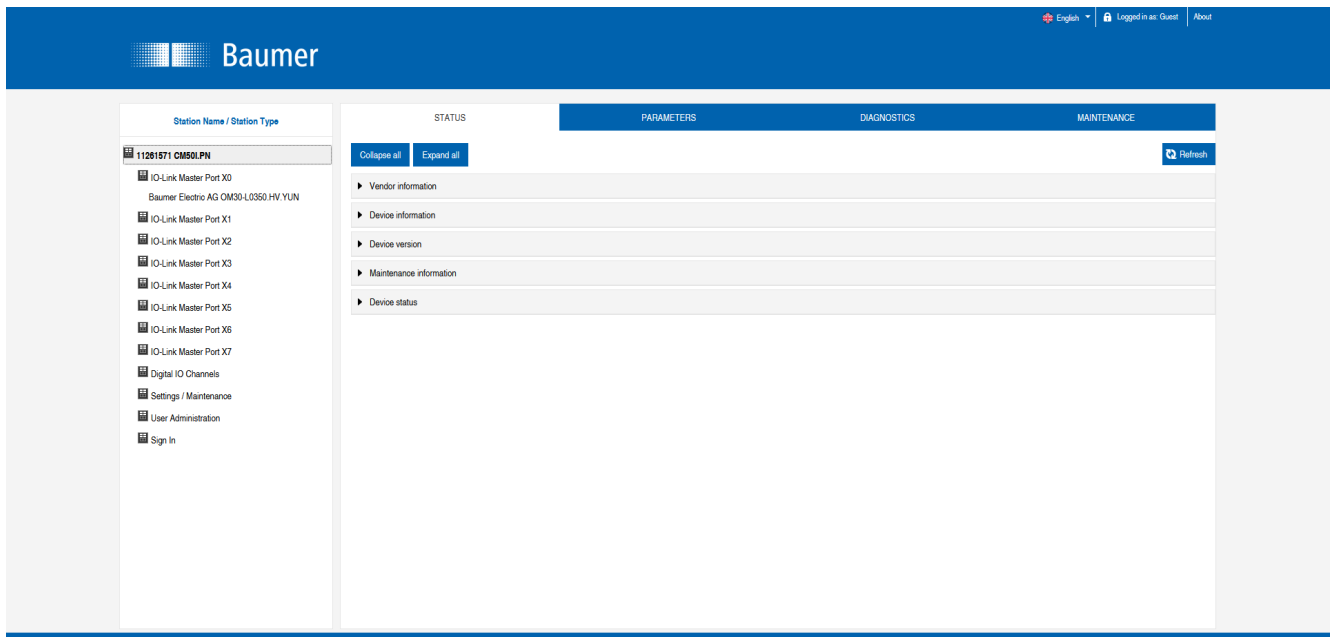

Ill. 87: Web server



INFO

The devices shown in the screenshots serve as examples.

11.1 Starting the web server

Condition:

⇒ The current versions of the following browsers with HTML5 and ES5 are supported: *Mozilla Firefox, Microsoft Edge, Google Chrome.*

Instruction:

- a) Start the web browser.
- b) Enter the device IP address in the web browser.

Result:

- ✓ The start screen of the web server is the **Status** page.

11.2 Access and login

Username and password

Instruction:

- ◆ Enter the login data for user name and password at the first start:
 - User name <admin>
 - Password <private>

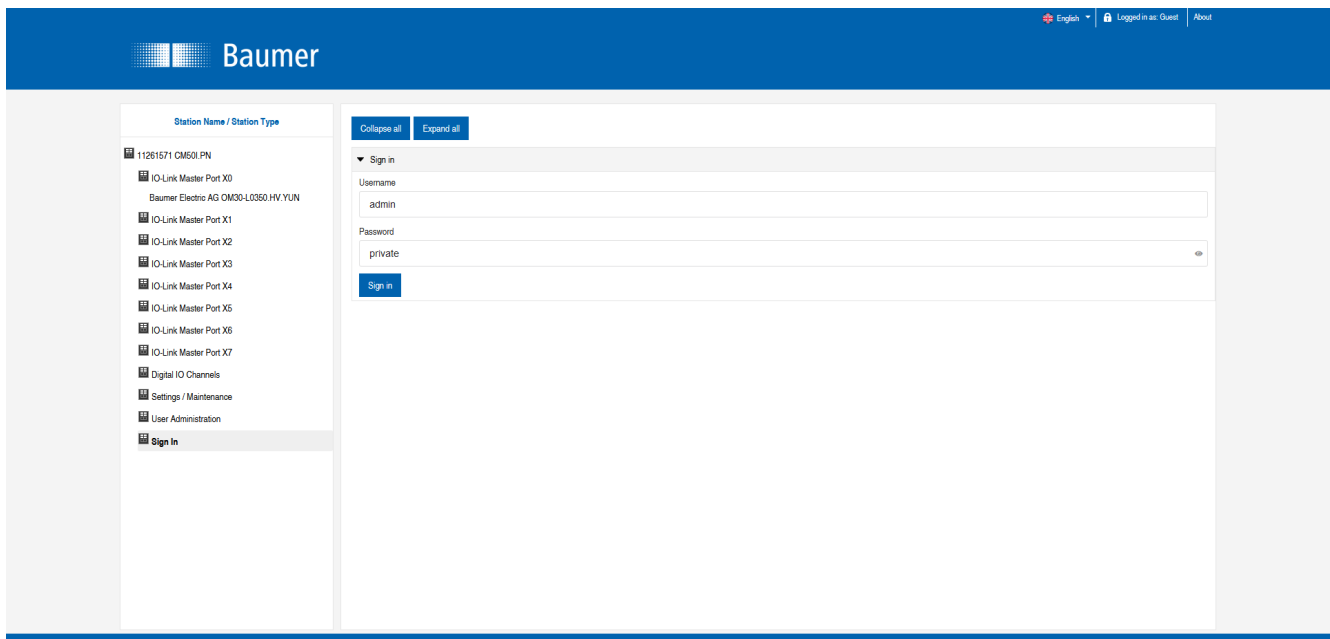

Change password

NOTICE

Ensure data security!

- a) Change username and password after first login and after every restore default.

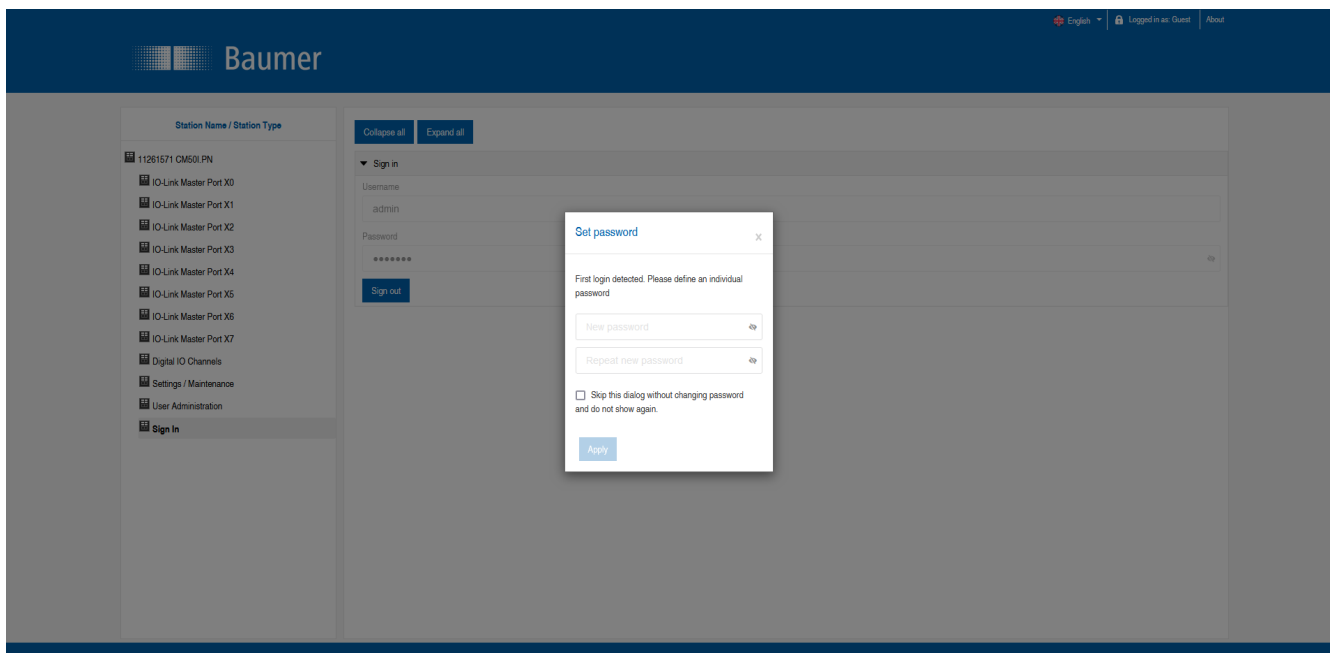

11.3 Initial screen

Operating areas

The web server provides 4 operating areas.

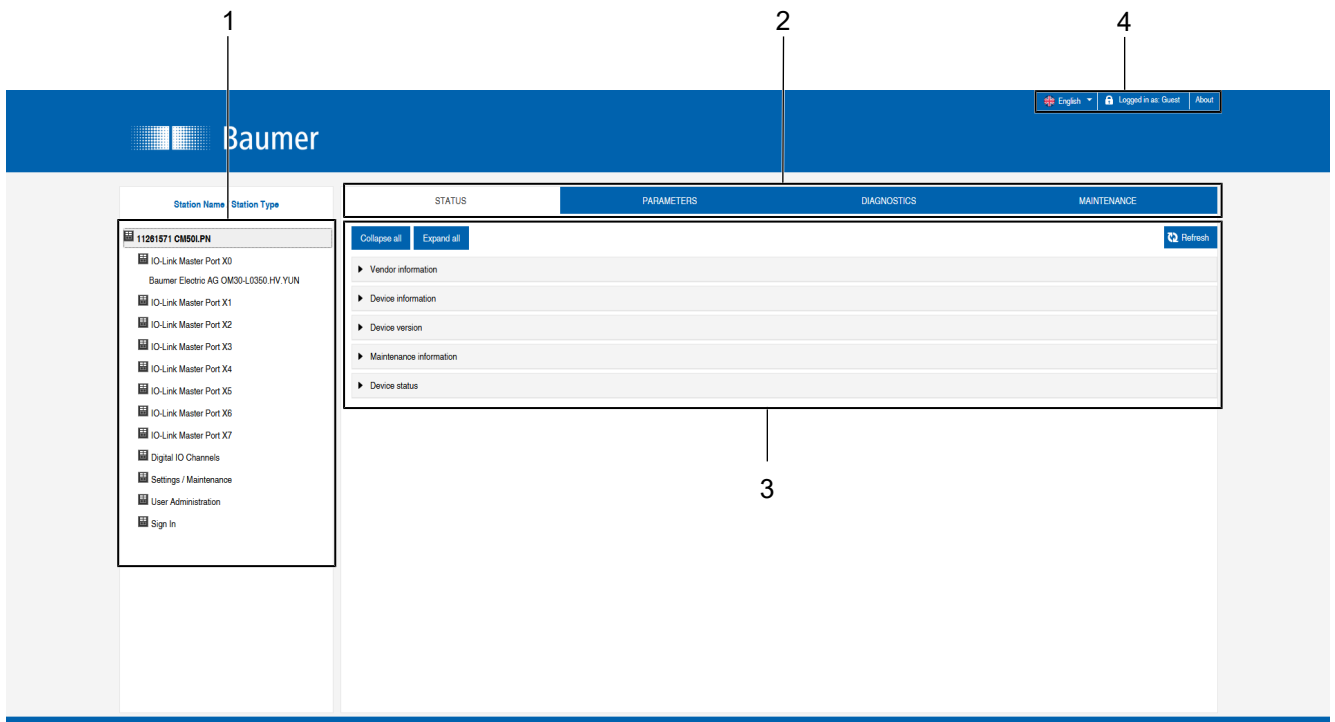

III. 88: Operating areas

1	System tree	Provides device and available sub functions.
2	Menu bar	The menu bar can be used to switch between the different pages of the device or the sub-function. In addition, the white highlighting indicates which page you are currently on.
3	Page content	This area displays the content of the selected page.
4	Header bar	Language and interface settings, system information.

11.4 Menu bar

The first line in the system tree provides device with article number and product name.

The menu bar comprises the following menu items:

- **Status**
- **Parameter**
- **Diagnostic tools**
- **Preventive maintenance**

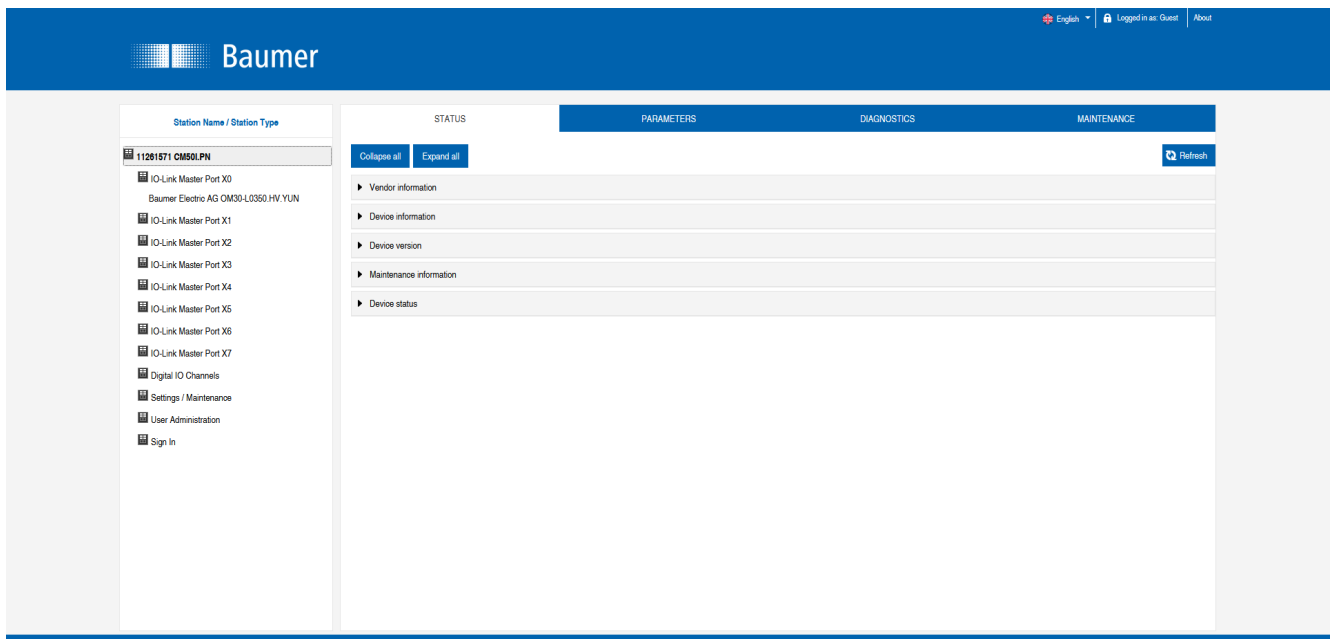

III. 89: Menu bar

11.4.1 STATUS menu

The **Status** menu item contains the following sub-items:

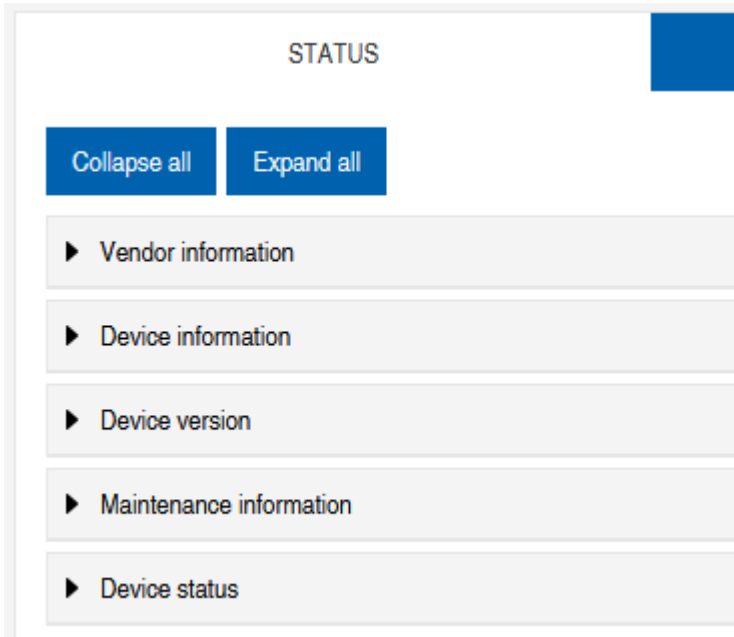

III. 90: **Status** menu item

Manufacturer information

Manufacturer information displays the following information:

Parameter designation	Description
Manufacturer name	Fixed data from the manufacturer
Manufacturer address	Fixed data from the manufacturer
Manufacturer telephone	Fixed data from the manufacturer
Manufacturer URL	Website of the manufacturer

Device information

Device information displays the following information:

Parameter designation	Description
Order number	Article number of the device
Hardware name	Permanent article number of the device
Software name	Fieldbus designation of the device
Software number	Device manufacturing number

Device version

Device version displays the following information:

Parameter designation	Description
Hardware version	Hardware execution version
Software version	Software version run in the device
Website version	Web server version currently run in the device

Maintenance information



INFO

Maintenance information is read only. The fields are entered or changed via **Settings/Maintenance | Maintenance information**.

Maintenance information provides the following information:

Parameter designation	Description
Name	Device name, free text
Installation location	Name of place, free text
Contact information	Contact, free text
Description	Description, free text
Last maintenance date (yyyy-mm-dd)	Free date entry
Next maintenance date (yyyy-mm-dd)	Free date entry

IO-Link device information

IO-Link device information displays the following information:

Parameter designation	Description
1L Voltage [V]	Provides sensor voltage in volts
1L Current [A]	Provides sensor voltage in amperes
2L Voltage [V]	Provides actuator voltage in volts
2L Current [A]	Provides actuator voltage in amperes
Temperature [°C]	Display of the appliance temperature in Celsius
Total operating time [hh:mm:ss]	Operating time since the device was switched on
Number of starts	Number of restarts

11.4.2 Menu PARAMETERS

The **Parameters** menu item contains the following sub-items:

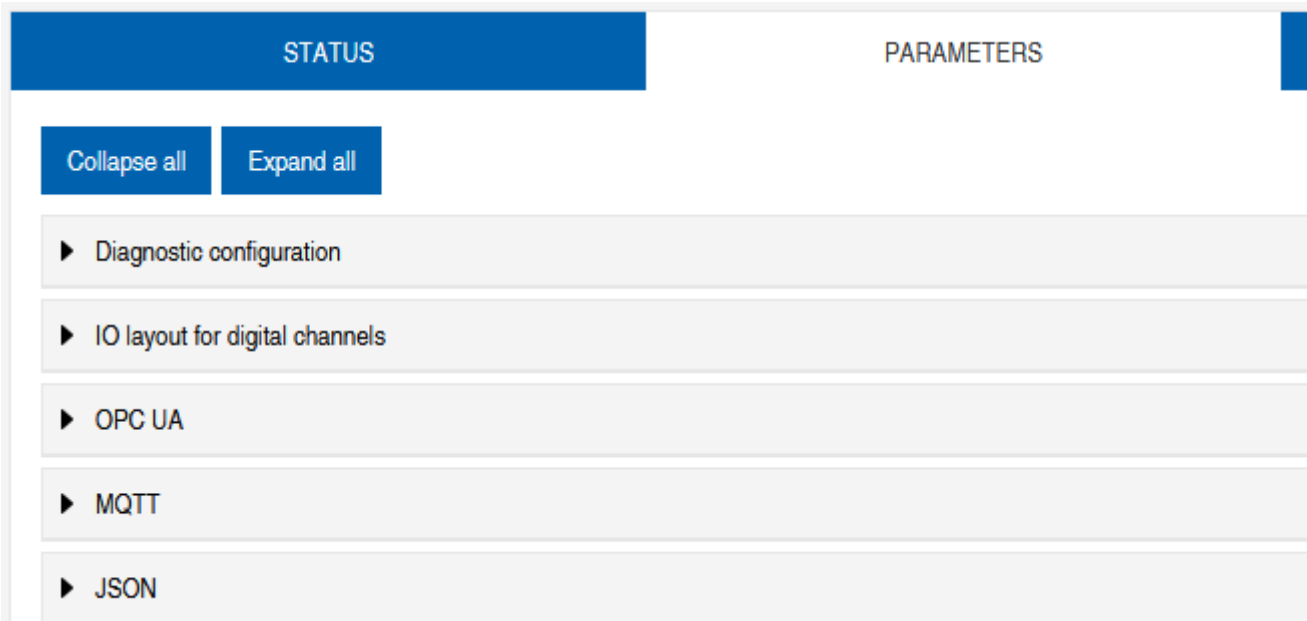

Ill. 91: **Parameter** menu

OPC UA

Users with admin and operator rights can change settings and enter the OPC UA port number. Guest users with read rights only.

OPC UA displays the following information:

Parameter designation	Description
Activate OPC UA Server	OPC UA server on the module active / passive
Allow OPC UA clients to write ISDU data	OPC UA client may write ISDU data (Indexed Service Data Unit) to the module on the IO-Link master
Allow OPC UA clients to write PDO data	OPC UA client may write PDO (process data objects) to the module on the IO-Link master
OPC UA port number	Display / definition of the OPC UA port

MQTT

Users with admin and operator rights can change settings and enter the IP address of the MQTT server. Guest users with read rights only.

MQTT displays the following information:

Parameter designation	Description
Enable MQTT	MQTT client on component active / passive
MQTT server IP address	MQTT server IP address
MQTT Client ID	Read/write MQTT client ID
Client head topic	Read/write MQTT topic
Topic for system data	Read/write MQTT topic

JSON

Users with admin and operator rights can activate and deactivate JSON. Guest users with read rights only.

JSON displays the following information:

Parameter designation	Description
Enable JSON	JSON interface on component active / passive

11.4.3 DIAGNOSTICS menu

The incoming and outgoing alarms of the master are displayed in the **Diagnosics** menu item.

The menu shows an overview of the diagnostic messages.

Depending on the setting in the **Please select an entry** drop-down menu, the following device diagnostics are displayed:

- **Enabled**
 - All pending diagnostics at the time of the web server call.
 - All diagnoses that no longer exist are not displayed.
- **History**
 - All diagnostics from the retentive diagnostics memory that no longer exist are displayed.
 - More than 40 diagnostics in the memory. The latest diagnostics overwrites the most previous one in the memory.

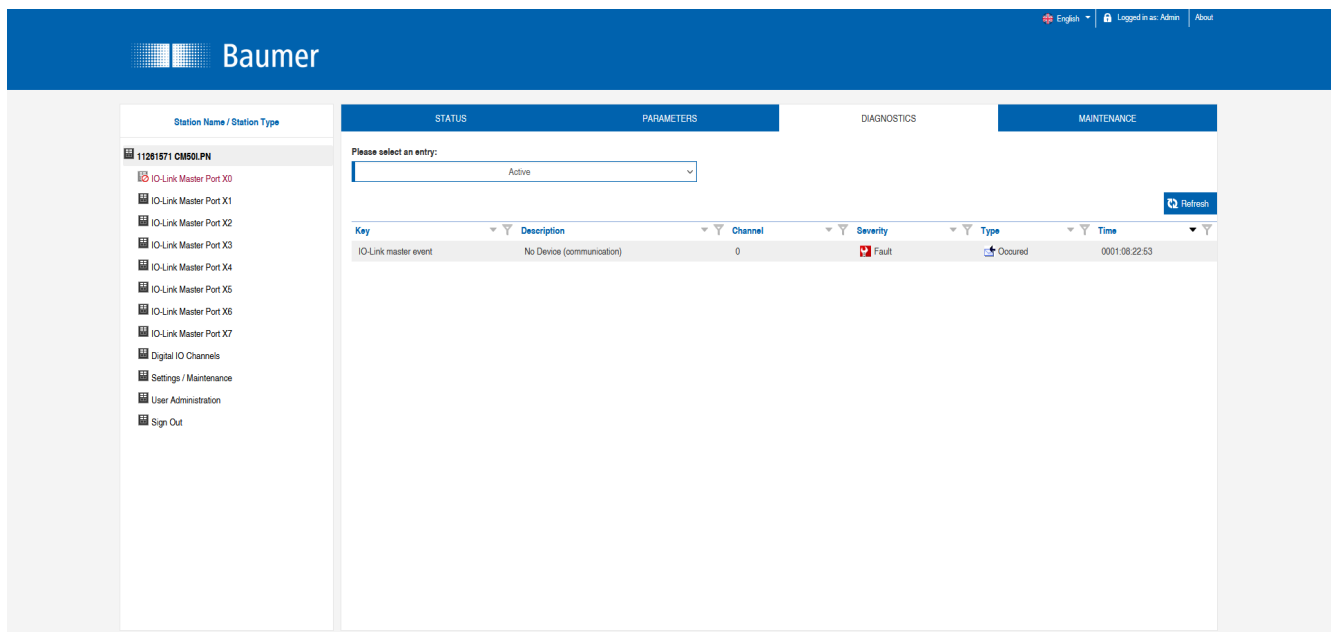

III. 92: **Diagnosics** menu item

11.4.4 MAINTENANCE menu

In the **Maintenance** menu item, users with admin and operator rights can delete the diagnostic memory.

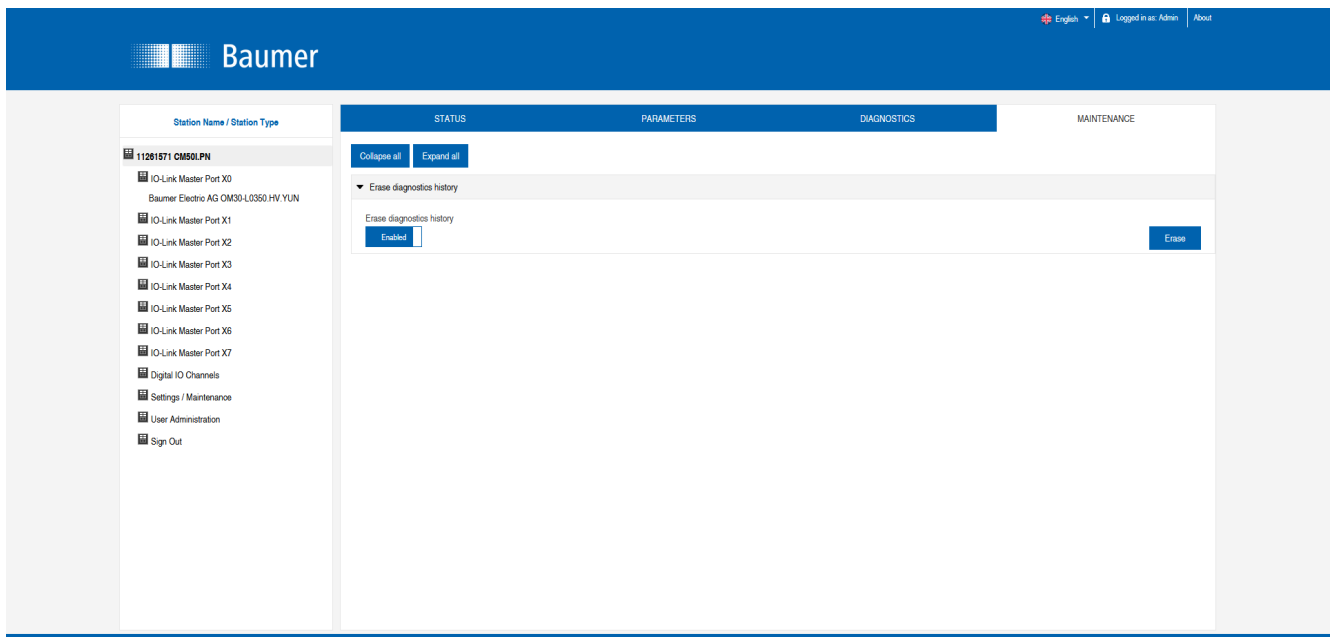

///. 93: Delete diagnostic memory

11.5 IO-Link master port

The system tree provides 8 IO-Link master ports (X0 ... X7) for individual selection. According to the user role, information is read only or enables configuration.

In active IO-Link communication, the IO-Link device name automatically appears under the relevant port.

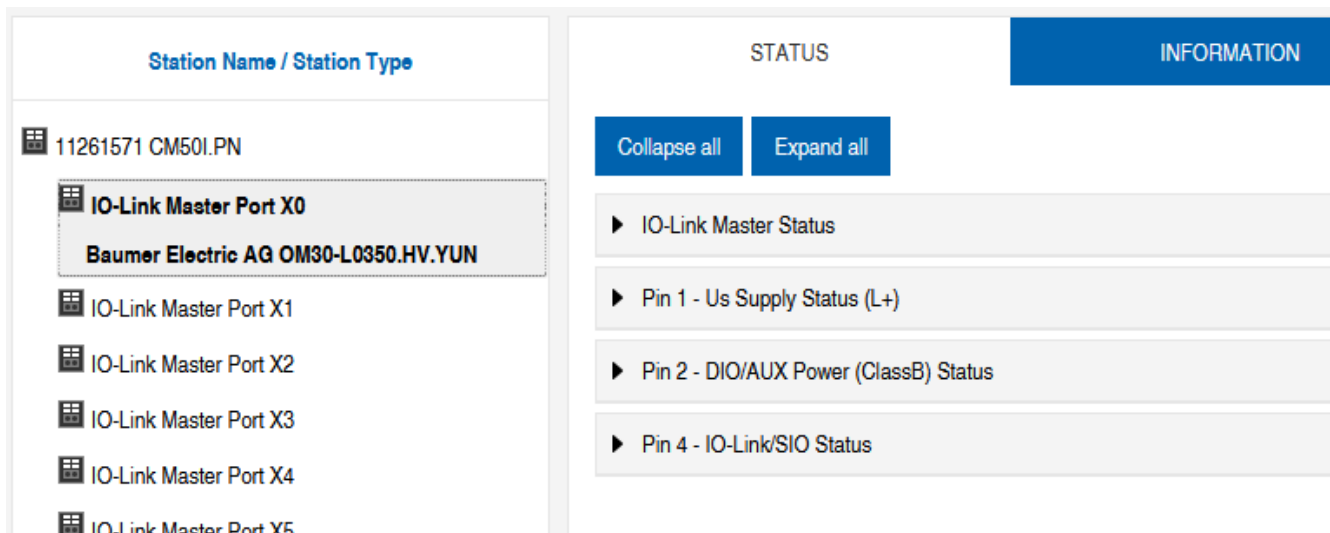

///. 94: IO-Link master port

11.5.1 STATUS menu

The IO-Link master status is displayed here in the **Status** menu.

STATUS	INFORMATION	CONFIGURATION
Collapse all Expand all		
▼ IO-Link Master Status		
- State		Operate
- Quality		0x2
- Revision ID		0x11
- Baudrate		230.4 kbps
- Cycle time		1.0 ms
- Input data length		6
- Output data length		1
- Vendor ID		0x15E
- Device ID		0x25F

///. 95: IO-Link master port - IO-Link master status

If pin 4 is in IO-Link mode, all relevant IO-Link data including the I/O bytes of the device are displayed.

If pin 4 is in operation without a connected IO-Link device, it is displayed that no device is connected.

▼ IO-Link Master Status		
- Port function		Digital input

///. 96: IO-Link master port - IO-Link master status for digital operation

If pin 4 is configured as a digital input, you can see it here.

Optional indication of:

- Status: Disabled
- Status: Digital input
- Status: Digital output

Port Status - Pin 1

Port status - pin 1 provides the following information

Parameter designation	Description
Temperature [°C]	Temperature in degrees Celsius
Voltage [V]	Voltage in Volts
Current [A]	Current in Ampere
Status	Pin status

Port Status - Pin 2

Port status - pin 2 provides the following information

Parameter designation	Description
Temperature [°C]	Temperature in degrees Celsius

Parameter designation	Description
Voltage [V]	Voltage in Volts
Current [A]	Current in Ampere
Status	Pin status

Port Status - Pin 4

Port status - pin 4 provides the following information

Parameter designation	Description
Temperature [°C]	Temperature in degrees Celsius
Voltage [V]	Voltage in Volts
Current [A]	Current in Ampere
Status	Pin status

11.5.2 INFORMATION menu

Menu item **Information** provides the following subitems:

STATUS	INFORMATION	CONFIGURATION	IO-LINK PARAM
Collapse all Expand all			
▼ IO-Link Device Information			
- Min cycle time	1.0 ms		
- Function ID	0		
- Number of profile IDs	1		
- Vendor name	Baumer Electric AG		
- Vendor text	www.baumer.com		
- Product name	OM30-L0350.HV.YUN		
- Product ID	11232075		
- Product text	Optical distance sensor, Connector M8		
- Serial number	R245.85343		
- Hardware revision	01.00.01		
- Firmware revision	01.01.09		

III. 97: IO-Link Master Port – Information

IO-Link device information

Technical data and manufacturer information of a connected and active IO-Link device is provided at the related master port.

“IO-Link device information” provides the following information:

Parameter designation	Description
Minimum. cycle time	Minimum process cycle time of IO-Link device
Function ID	Function ID IO-Link device
Number of profile IDs	Number of profiles supported by the IO-Link device
Manufacturer name	Manufacturer name IO-Link device
Manufacturer text	Manufacturer text IO-Link device

Parameter designation	Description
Product name	Product name IO-Link device
Product ID	Article number IO-Link device
Product text	Additional description IO-Link device
Serial number	Serial number
Hardware version	Hardware version
Firmware version	Firmware version

11.5.3 CONFIGURATION menu

Menu item **Configuration** of the selected IO-Link port provides the setting of pin 1, pin 2 and pin 4 and allows also for configuration.

Users with operator and admin rights can set the functions and behavior of pin 1, pin 2 and pin 4.

Users with service and maintenance rights have read rights.

Pin 4 can be deactivated or configured as an IO-Link master, input or output.

/// 98: IO-Link master port - configuration (pin 4)

Pin 2 can be deactivated or configured as an input, output or DIO in **Automatic Mode**.

/// 99: IO-Link master port - Configuration - IQ behavior (pin 2)

If pin 2 or pin 4 is configured as an input, the digital input filters can be set individually.

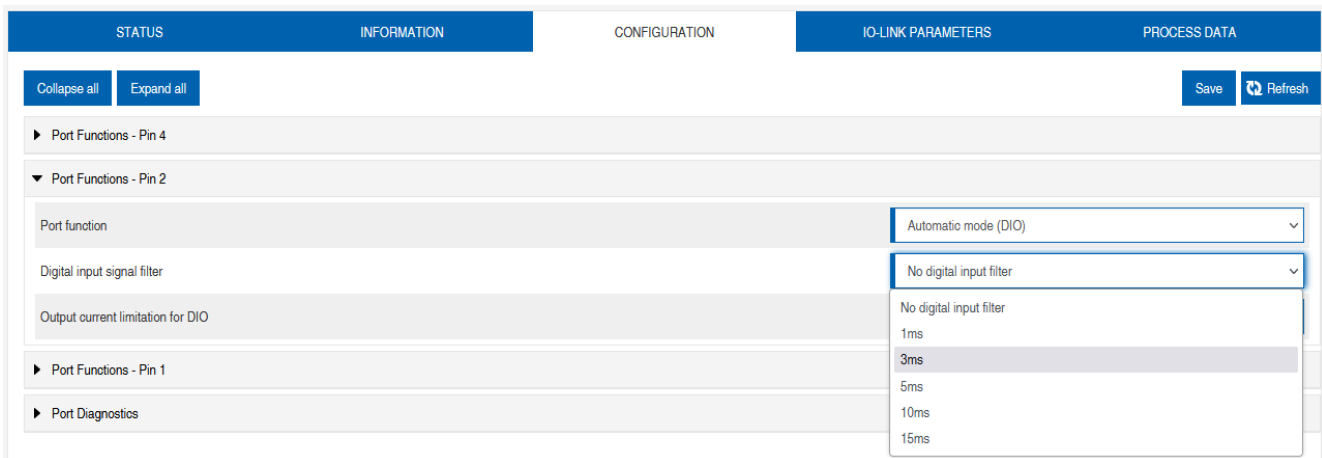

III. 100: IO-Link master port - Configuration - Setting digital input filters

11.5.4 IO-LINK PARAMETERS menu

In this menu item, the *ISDU (Index Service Data Unit)* of the device can be read and written during IO-Link operation. This primarily allows an IO-Link device to be evaluated or parameterized without a controller. The input can be made in both hex and ASCII format.



INFO

Observe the information in the IO-Link device manufacturer's manual.

Users with maintenance and admin rights can write ISDU values. Users with service rights have read rights.

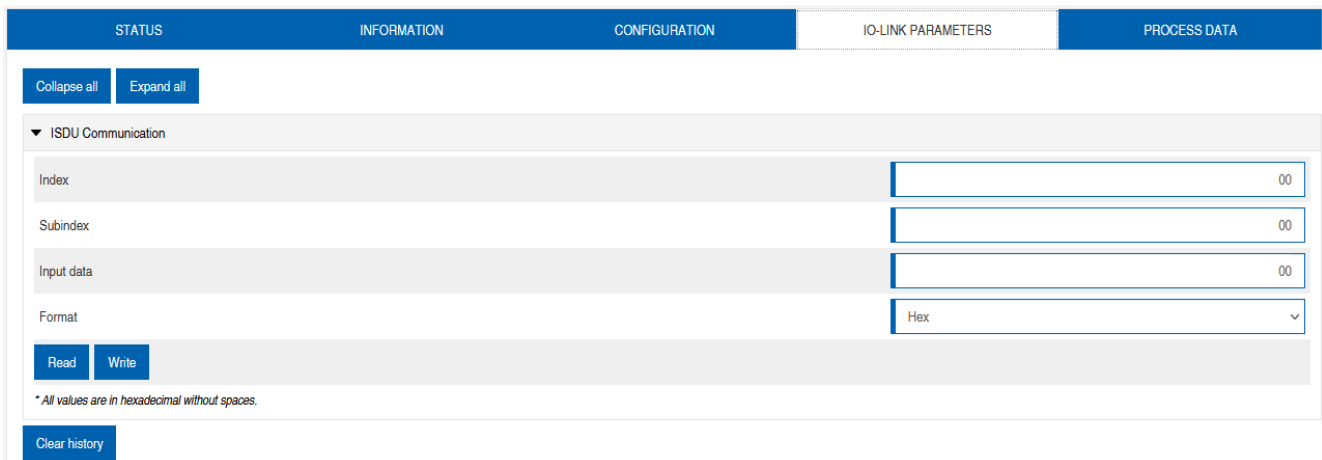

III. 101: IO-Link master port - IO-LINK PARAMETER

11.5.5 PROCESS DATA menu

In the **Process data** menu item, the current process data of the connected IO-Link device is continuously displayed if pin 4 of the corresponding port has been configured as an IOL port. Example: Port X2: Pin 4 (IO- Link Autostart) and Pin 2 (Digital output static on).

STATUS	INFORMATION	CONFIGURATION	IO-LINK PARAMETERS	PROCESS DATA
Collapse all Expand all				
▼ Process Data				
Pin 4 IOL Input				00,01,0f,42,fa,01
Pin 4 IOL Output				00
Force Pin 4 IOL Output Data			Write Disable Forcing	0
Pin 2 DO				0
Pin 2 DI				0
Format				Hexadecimal

III. 102: IO-Link Master Port - PROCESS DATA

The current statuses of the digital inputs are displayed in this menu item. Example: Port X1: Pin 4 (DI) and pin 2 (DI)

STATUS	CONFIGURATION	PROCESS DATA
Collapse all Expand all		
▼ Process Data		
Pin 4 DI		0
Pin 2 DO		0
Pin 2 DI		0
Format		Hexadecimal

III. 103: IO-Link master port - Digital inputs - PROCESS DATA

11.6 Digital IO channels/ IO overview

In the **Configuration** menu of the selected IO-Link port, the setting of pin 2 and pin 4 on the selected port is displayed. Outputs can be set under certain conditions.

11.6.1 Input data

Each user can monitor the digital statuses of the inputs configured on the device.

Station Name / Station Type	IO OVERVIEW
11261571 CM50I.PN	Collapse all Expand all
IO-Link Master Port X0	▼ Input data
IO-Link Master Port X1	Port X0 Pin 4 (Channel 00) Disabled
IO-Link Master Port X2	Port X0 Pin 2 (Channel 10) Disabled
IO-Link Master Port X3	▶ Allow forcing outputs
IO-Link Master Port X4	▶ Output data
IO-Link Master Port X5	
IO-Link Master Port X6	
IO-Link Master Port X7	
Digital IO Channels	
Settings / Maintenance	
User Administration	
Sign Out	

III. 104: Overview of input data

11.6.2 Output data

Allow outputs to be set

Users with admin, service and maintenance rights can allow the outputs to be set in this menu.

The right to do this is only granted if the device is not in an active fieldbus connection with the control unit. The control system has priority.

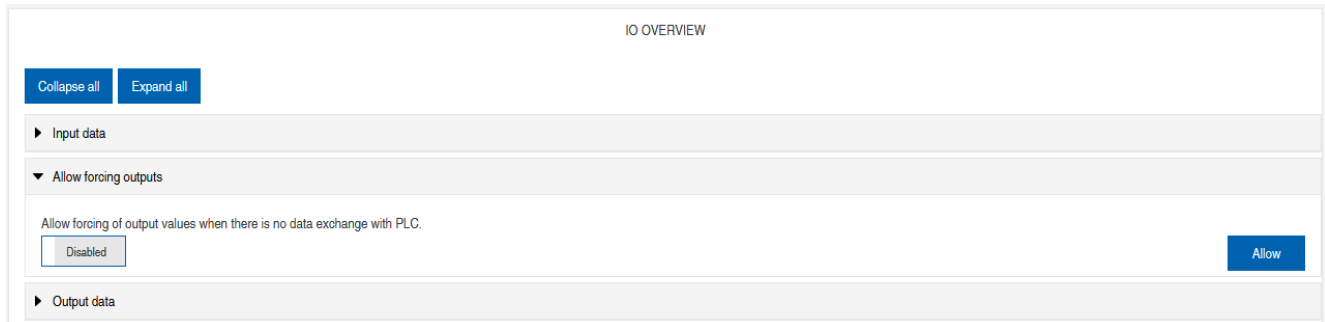

III. 105: Allow outputs to be set

Setting output data

Guest users are not permitted to set the exits.

All other users (admin, operator, maintenance) can set the outputs.

As soon as the user (admin, operator, maintenance) logs out, the outputs go to 0.

As soon as a fieldbus is actively working with the device, the outputs go to 0 and then adopt the status that they receive from the controller.

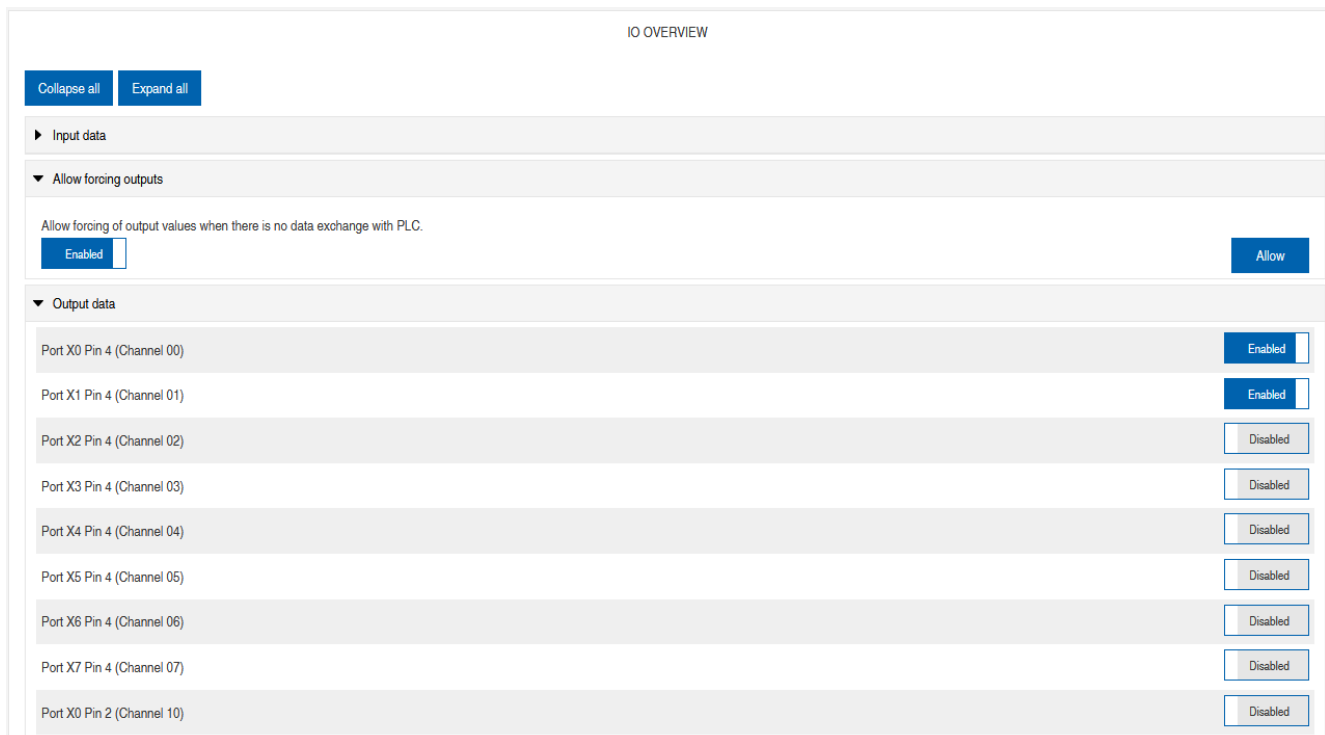

III. 106: Setting output data

11.7 Settings and maintenance

11.7.1 DEVICE CONFIGURATION menu

In Profinet, the address is usually assigned by the controller using DCP. Only the IP setting can therefore be read in the web server.

The screenshot shows the Baumer web server interface. The top navigation bar includes 'English', 'Logged in as: Admin', and 'About'. The main content area is divided into several tabs: 'DEVICE CONFIGURATION', 'MAINTENANCE INFORMATION', 'FIRMWARE', and 'FACTORY RESET'. The 'DEVICE CONFIGURATION' tab is active, showing a 'Collapse all' and 'Expand all' button, and a 'Refresh' button. Below these, the 'Interface configuration status' section is expanded, displaying three input fields: 'Device IP address' (192.168.0.250), 'Subnet mask' (255.255.255.0), and 'Gateway IP address' (0.0.0.0). The left sidebar lists the station name '11261571 CM50I.PN' and various IO-Link Master ports (X0 to X7) and Digital IO Channels. The 'Settings / Maintenance' menu item is highlighted.

III. 107: Settings IP address Profinet

11.7.2 MAINTENANCE INFORMATION menu

Users with service, maintenance and admin rights can enter information about the device here.

The screenshot shows the Baumer web server interface. The top navigation bar includes 'English', 'Logged in as: Admin', and 'About'. The main content area is divided into several tabs: 'DEVICE CONFIGURATION', 'MAINTENANCE INFORMATION', 'FIRMWARE', and 'FACTORY RESET'. The 'MAINTENANCE INFORMATION' tab is active, showing a 'Collapse all' and 'Expand all' button, and a 'Refresh' button. Below these, the 'Maintenance information' section is expanded, displaying a 'Maintenance data changed' message and several input fields: 'Name' (Station 123), 'Installation location' (Hall 123), 'Installation date (yyyy-mm-dd)' (2023-03-03), 'Contact information' (Smith), 'Description' (First Teststation), 'Last service date (yyyy-mm-dd)' (2024-03-03), and 'Next service date (yyyy-mm-dd)' (2025-03-03). An 'Apply' button is located at the bottom of the form. The left sidebar lists the station name '11261571 CM50I.PN' and various IO-Link Master ports (X0 to X7) and Digital IO Channels. The 'Settings / Maintenance' menu item is highlighted.

III. 108: Maintenance information setting

The maintenance information appears in the device in the **Status** menu item and **Maintenance information** submenu.

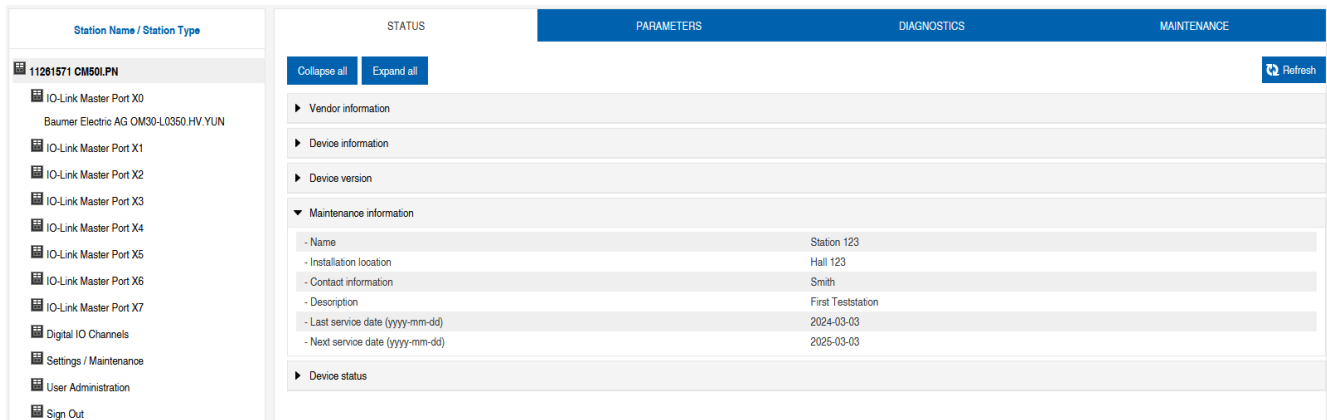

III. 109: Maintenance information status

11.7.3 FIRMWARE menu

This menu item displays the data of the firmware running on the device.

Users with service, maintenance and admin rights can upload new firmware, provided in ZIP folders, to the device here. After successful loading, the device checks the firmware container and starts automatically with the new firmware version.

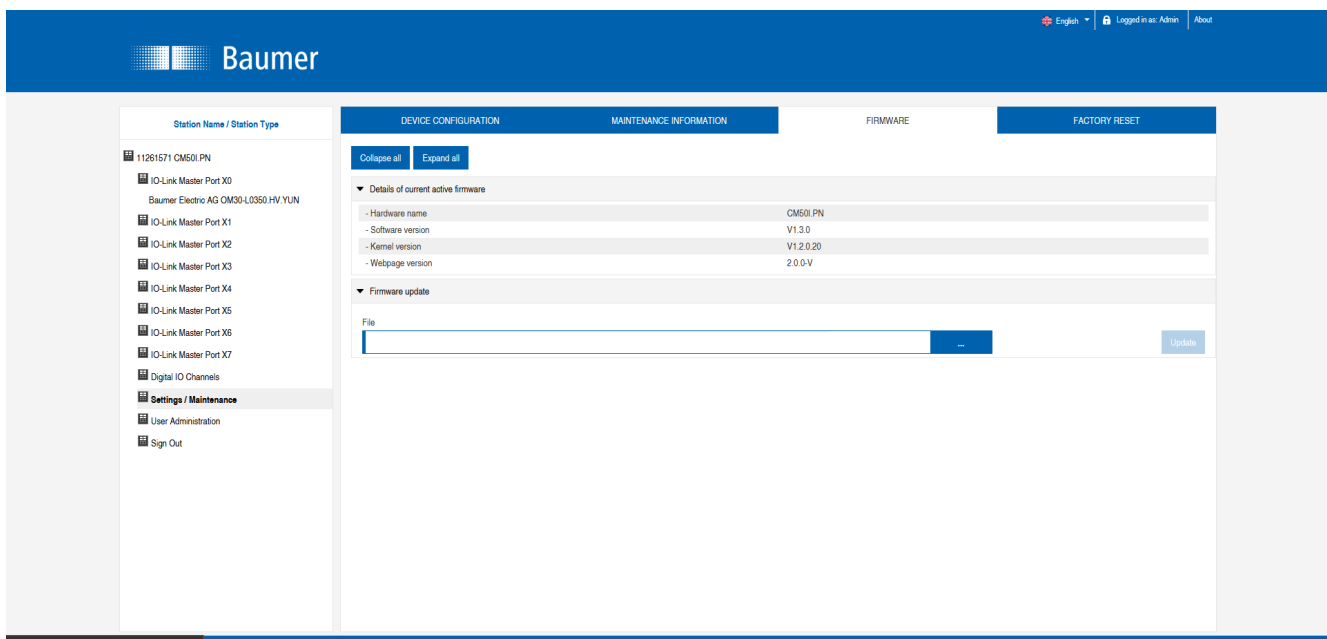

III. 110: Firmware

11.7.4 WORK RESET menu

In this menu item, users with service, maintenance and admin rights can reset the entire device or individual sub-areas (device information, network, application).

The screenshot shows the Baumer web interface with the 'FACTORY RESET' tab selected. The left sidebar contains a tree view with 'Settings / Maintenance' highlighted. The main content area has a 'Factory reset' section with four radio button options:

- Delete stored device information e.g. Device Maintenance Information, NTP settings, OPC UA IO-Link Master specific tags, etc.
- Delete stored network adapter settings e.g. Communication and IP Address Configuration, Name Of Station, etc.
- Delete stored application parameters e.g., Port Configuration and Parameters, IO-Link Data Storage, etc.
- Delete all stored settings

Buttons for 'Delete settings' and 'Restart' are located below the options.

III. 111: Factory reset

11.8 User administration

User administration can only be carried out with admin rights.

When the product is delivered, the administrator is called `admin` and has the password `private`.



INFO

The administrator default password can be changed from the control unit in the system with the field bus running.

Users log in and off in the system tree at the bottom left.

- ◆ Click on **Logout**.

The screenshot shows the Baumer web interface with the 'USER ADMINISTRATION' tab selected. The left sidebar contains a tree view with 'User Administration' highlighted. The main content area has a 'User list' table and an 'Add new user' form.

Username	Userrole	Actions
Operator	Operator	
SansSmith	Maintenance	
admin	Admin	

The 'Add new user' form has fields for Username, Password, and Userrole, and an 'Add' button.

III. 112: User administration

12 Maintenance and cleaning

⚠ WARNING**Material damage due to defective or damaged appliances.**

The function of the devices is not guaranteed.

- a) Replace defective or damaged devices.
-

**INFO**

You can replace the device with the same type if maintenance is required.

- a) Check whether the switch settings of the old and new device are identical.
-

**INFO**

Cleaning the appliance.

- a) Only use oil-free compressed air or spirit.
 - b) Only use non-fibrous materials (e.g. leather cloth).
 - c) Do not use contact spray.
-

13 Annex

13.1 Accessories

13.1.1 Tools

Designation	Art. no.
M12 installation wrench set SW 13	11238694
M12 mounting wrench bit SW 17	11238695



III. 113: Assembly wrench



INFO

PRODUCTS AND ACCESSORIES

You can find a large selection of products at: <https://www.baumer.com>

13.2

Glossary

Term	Description
Bus-Run-LED	LED for signaling the bus status.
CfgF-LED	LED for signaling correct/incorrect configuration.
Bytes	iTerm from IEC 61158. Corresponds to 1 byte or 8 bits.
DI	Digital Input
DIP switch	Dual in-line package/switch with two parallel rows of connections.
DO	Digital output/digital output
EMC	Electromagnetic compatibility
EN	European standard
ESD	Electrostatic discharges
FE	Functional earth
IIoT	The Industrial Internet of Things (IIoT) is the industrial version of the Internet of Things (IoT). In contrast to the IoT, it does not represent consumer-oriented concepts, but focuses on the application of the Internet of Things in the manufacturing and industrial environment.
IN	Input

Term	Description
I&M data	For identification and maintenance (I&M), data records (data structures) have been defined for PROFIBUS, which must be implemented for all devices with DP-V1. These data structures are used to uniquely identify the field device and facilitate maintenance.
IO-Link	Standardized communication system for connecting intelligent sensors and actuators to an automation system
IRT	Isochronous real time/protocol for clock-synchronous activation of data and functions on different devices.
IP67	Ingress protection according to DIN EN 60529
IP address	Address for identification in an Ethernet network
LED	Light Emitting Diode
LNK/ACT-LED	Link/Activity LED for signaling Ethernet communication.
MAC address	MAC address stands for Media Access Control address and represents the unique identifier of a network interface. The MAC address is often also referred to as the physical address.
MRP	Media Redundancy Protocol/A protocol for the management of ring topologies in a production plant. It is used to increase the availability of devices in the network.
n.c.	Not connected
OUT	Output
PELV	Protective Extra Low Voltage
Power-LED	LED for signaling the power supply
PROFINET	Process Field Network
PROFenergy	PROFINET profile for energy management in production plants
PQI	The port qualifier information (PQI) provides status information about the IO-Link port or the device status.
SELV	Safety Extra Low Voltage with safe isolation.
Shared Device (SD)	Protocol extension of a PNIO device to establish simultaneous communication relationships with several PNIO controllers.
SNMP	Simple Network Management Protocol/Protocol for simple monitoring and control of various network participants.
PLC	Programmable Logic Controller
UA	Actuator voltage
US	Sensor voltage
Validation IO-Link	Check for compatibility or identity of a connected IO-Link device.

