



Operating Manual

CM50I.EIP
IO-Link Master with EtherNet/IP

EN-US

1 About this document

1.1 Purpose and scope of application

This document instructs the technical staff of the machine manufacturer or machine operator on the safe use of the described devices.

It does not include instructions on the safe use of the machine in which the devices are integrated. Information on this is found in the operating manual of the machine.

- Read this chapter carefully before you start working with the device.
- Study the documentation carefully before device commissioning.
- Store the manual in a place that is accessible to all users at all times for the entire service life of the device.

Understanding the present manual requires general knowledge about automation technology. In addition, planning and using automation systems requires technical knowledge which is not included in this manual.

1.2 Applicable documents



- Available for download at www.baumer.com:
 - Instruction manual
 - Data sheet
 - Device description file
 - EU Declaration of Conformity
 - Certificates and Approvals
- Attached to product:
 - General information sheet (11042373)

1.3 Labels in this manual

Identifier	Usage	Example
<i>Dialog element</i>	Indicates dialog elements.	Click OK .
<i>Unique name</i>	Indicates the names of products, files, etc.	<i>Internet Explorer</i> is not supported in any version.
Code	Indicates entries.	Enter the following IP address: 192.168.0.250

1.4 Warnings in this manual

Warnings draw attention to potential personal injury or material damage. The warnings in this manual indicate different hazard levels:

Symbol	Warning term	Explanation
	DANGER	Indicates an imminent potential danger with high risk of death or serious personal injury if not being avoided.
	WARNING	Indicates potential danger with medium risk of death or (serious) personal injury if not being avoided.
	CAUTION	Indicates a danger with low risk, which could lead to light or medium injury if not avoided.
	NOTE	Indicates a warning of material damage.
	INFO	Indicates practical information and tips that enable optimal use of the devices.

1.5 Scope of delivery

Delivery includes:

- 1 x CM50I device
- 1 x instruction manual - multilingual
- 15 x designation label

1.6 Trademarks

The present documentation uses the trademarks of the following companies and institutions:

<i>EtherNet/IP</i>	ODVA, Inc.
<i>IO-Link</i>	c/o PROFIBUS User Organisation e.V. (PNO)
<i>STUDIO 5000 LOGIX DESIGNER</i>	Rockwell Automation Inc.

1.7 Software-Tools

Applied software
<i>Studio5000, Rockwell Automation Inc</i>
<i>Baumer Sensor Suite (BSS)</i>

1.8 Specifications

Specification	Link
<i>EtherNet/IP Spezifikation</i>	www.odva.org
<i>IO-Link</i> Version 1.1.2 of 07.2013	www.io-link.com



INFO

The features of IO-Link specification V 1.1.3 are supported.

2 General information

Intended use

This product is a precision device and serves the detection of items, objects, or physical measurement variables and the preparation or provision of measured values as electric variables for the higher-level system.

Unless specifically labeled, this product may not be used in explosive environments.

Commissioning

Assembly, installation, and calibration of this product may only be performed by a specialist.

Installation

Only use the fasteners and fastener accessories intended for this product for installation. Outputs not in use must not be wired. Unused wires of cable outputs must be insulated. Do not go below the permissible cable bending radii. Disconnect the system from power before the product is electrically connected. Use shielded cables to prevent electro-magnetic interference. If the customer assembles plug connections on shielded cables, then EMC-version plug connections should be used and the cable shield must be connected to the plug housing across a large surface area.

Disposal (environmental protection)



Used electrical and electronic devices may not be disposed of in household waste. The product contains valuable raw materials that can be recycled. Therefore dispose of this product at the appropriate collection point. For additional information visit www.baumer.com.

3 Safety

3.1 General safety instructions



⚠ DANGER

High electrical voltage in the machine/system.

Death or severe injuries resulting from electric shock.

- a) While working on the machine/devices, comply with the five safety rules of electrical engineering.

Protection of persons and material assets

- According to DIN VDE 0105-100 - Operation of electrical systems - Part 100: General definitions

The 5 Safety Rules

Protect against *high electrical voltage*

1. Switch off the device.
2. Secure against unwanted switchon.
3. Ensure that each pole is not live respectively under voltage.
4. Grounding and short-circuiting.
5. Cover or block neighboring parts under voltage.

Qualified personnel

The appliance may only be installed, commissioned and operated by qualified personnel who have received safety training.

Qualified means fulfilling the following requirements:

- the personnel underwent suitable training in electrical engineering,
- the personnel is familiar with the safety standards which are common practice in automation engineering,
- the personnel has access to the Operating instructions and the present Instruction Manual,
- are familiar with the safety standards of automation technology,
- the personnel is familiar with the related and applicable basic and technical standards.

Intended use of the device

- During project engineering, installation, commissioning, operation, and testing of the device comply with the existing regulations on accident prevention as well as health and safety at work.
- Check material resistance against aggressive media.

**INFO**

Any manipulation/modification of hardware and software only qualified *Baumer* personnel, except for firmware updates.

**INFO**

Only use a power unit of max. 60 V DC respectively 25 V AC in single fault condition. Power supply must comply with *SELV* or *PELV*.

Protective measures by the machine operator

- Follow the instructions in this manual.
- Observe the specifications and operating instructions of each connected component.

4 Description

4.1 Device

CM50I.EIP is a fully encapsulated fieldbus device in plastic housing. It is particularly robust for deployment in harsh environments.

Properties	Description
Robust	Appropriate for multifaceted applications and use under extreme demands by virtue of: <ul style="list-style-type: none"> ▪ Durable plastic housing, ▪ No condensation thanks to fully encapsulated housing
Vibration resistant	Safety function guaranteed even under permanent vibrations
Resistant	Acid and alkali-resistant plastic to ensure long service life.
Tight	Tight up to protection IP67 (EN 60529)



4.1.1 Product name nomenclature

The nomenclature is based on a scheme indicating the product functionality.

CM50I	Product family
EIP	Function <ul style="list-style-type: none"> ▪ Ethernet/IP

4.1.2 Device structure

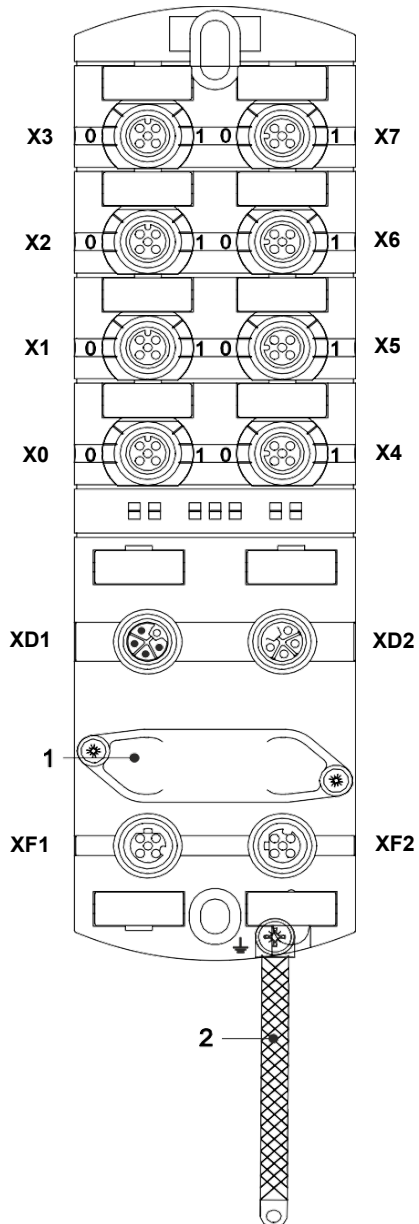

X0 ... X7 Digital I/O or IO-Link

M12 A-encoding

0 Channel corresponds to pin 4

1 Channel corresponds to pin 2

Examples:

Channel **02** = **Pin 4** port X2

Channel **16** = **Pin 2** port X6

XD1 Power supply POWER IN, M12

L-encoding 5-pin

XD2 Power supply POWER OUT,

M12 L-encoding 5-pin

1 Rotary switch

XF1 Ethernet Port 1, M12 D encoding

XF2 Ethernet Port 2, M12 D encoding

2 Ground strap for functional ground

4.1.3 Pin assignment

M12 female connector A-encoding

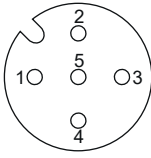
X0 ... X7		
	Pin 1	24V Us
	Pin 2	DIO / 24V Ua
	Pin 3	0V
	Pin 4	C/Q
	Pin 5	0V

M12 male/female connector, POWER IN/OUT

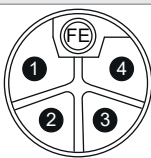
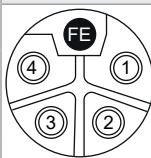
XD1			XD2
	Pin 1	24V Us	
	Pin 2	0V	
	Pin 3	0V	
	Pin 4	24V Ua	
	Pin 5	FE	

M12 female connector D-coded port 1 / port 2

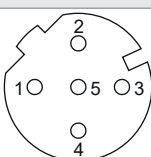
XF1 / XF2		
	Pin 1	Tx +
	Pin 2	Rx +
	Pin 3	Tx -
	Pin 4	Rx -
	Pin 5	n.a.
	Shield	FE

4.1.4 Display elements

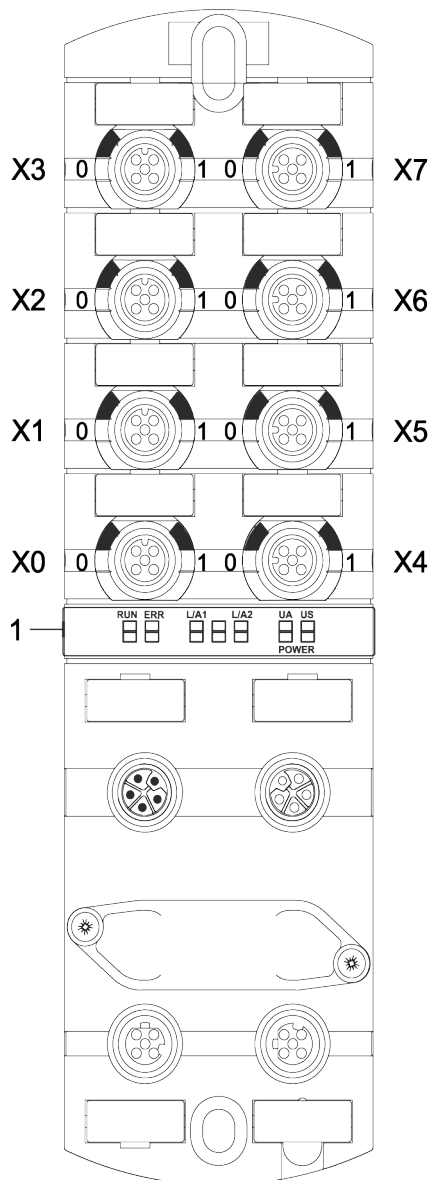

X0 ... X7 LED digital I/O or IO-Link

- 1 LED RUN
- LED ERR
- LED L/A1
- LED L/A2
- LED POWER UA
- LED POWER US

Also see about this

[LED indicator \[▶ 69\]](#)

4.2 IO-Link

IO-Link defines a standard where smart devices at sensor and actuator level connect to automation systems.

Communication takes place between the IO-Link master and one or more IO-Link peripheral devices. Each port connects a single device. IO-Link is a point-to-point communication standard, not a fieldbus system.

The IO-Link Master acts as interface between the superior fieldbus level and the IO-Link devices.

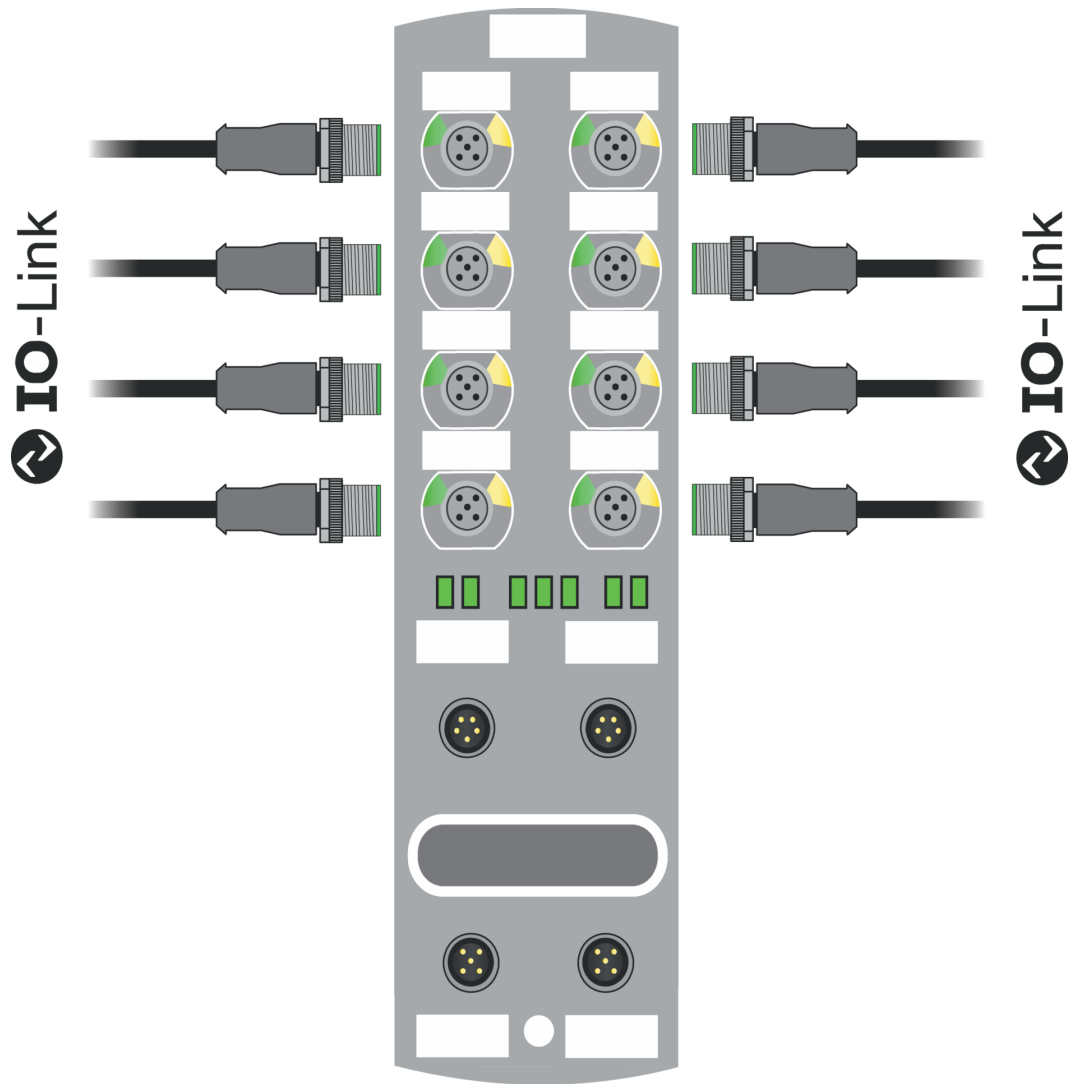

///. 1: IO-Link

IO-Link-Mode (IOL)

The IO-Link communication (C/Q) is assigned to pin 4, for connection and use of an IOL device.

Acyclic data may serve for writing device parameters of IO-Link devices or for reading parameters, measured values and diagnostic data from IO-Link devices.

IO-Link CALL

The following tasks can be performed:

- Parameterization/configuration of IO-Link devices during operation.
- Diagnostic of IO-Link devices by reading diagnostic parameters.
- Execute IO-Link port functions.
- Back-up/recovery of IO-Link device parameters.

IO-Link device data are uniquely addressed via index and sub-index.

Such data can be accessed with the so-called IOL CALL block. Usually, it is provided as data handling block by the PLC manufacturer.

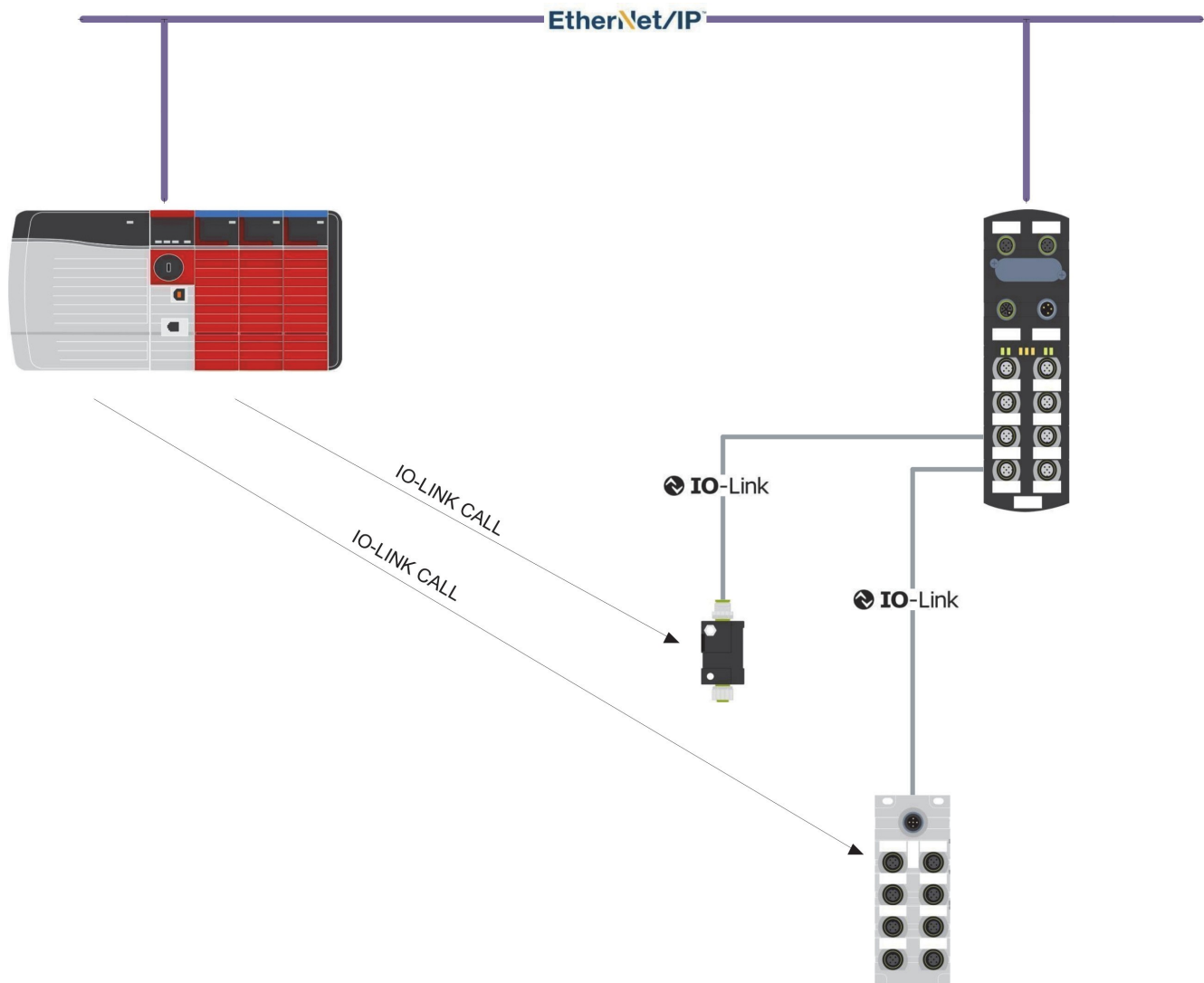

III. 2: IO-Link CALL

4.2.1 Data storage



INFO

Data storage is only available for IO-Link devices compliant to IO-Link version V1.1 and higher.

- Data storage allows for replacing IO-Link devices without the need for new configuration.
- IO-Link master and IO-Link device save the parameterization of the previous device.
- Data storage synchronizes the data memories of IO-Link master and IO-Link device.
- Once the IO-Link device has been replaced, the master will write the saved parameters into the new device, provided data storage is enabled in the IO-Link Master.
- This allows for application restart without parameterization from scratch.
- When replacing the IO-Link master, the new Master will read parameterization out of the IO-Link device and save it. Doing so requires the data storage option “Save and restore” being enabled.
- This allows for application restart without parameterization from scratch.
- For data storage application, vendor ID and device ID of the connected IO-Link device must be entered in the validation settings of each IO-Link master port.
- The IO-Link port mode must be set to “Manual”.

- To store the modified IO-Link device parameters again in the master, device parameterization must be done via block parameterization.
 - After this, the device transmits an upload request to the Master.
 - Block parameterization can be carried out via the IO-Link device tool in the “Parameter” window and with the “Block Write Mode”.
 - Optionally, block parameterization can be done by device parameter writing via web server or PLC block, e.g. Siemens IOL_Call.
 - Always terminate block parameterization with command "Parameter Download Store" ISDU Index 0x02 Subindex 0 Value 05.
- In validation/backup mode “no Device check”, the saved device parameter content in the IO-Link master is deleted.

4.3

EtherNet/IP

4.3.1

Communication

EtherNet/IP is based on a producer/receiver communication model with fast *Report-by-Exception* response by multicast Ethernet communication.

The connection to the control scanner can only be established in *EtherNet/IP* networks via 10/100MBit/s Ethernet switches.



INFO

Observe the maximum permitted cable length of 100 m to the end point without use auxiliaries.

The device integrates 2-port switch (target). The switches transmit multicast messages to every switch port and act like a hub here. Using unmanaged switches means the more multicast users (*Ethernet/IP* user) are added to the system, the higher the multicast traffic to them. This implicates consuming a larger amount of bandwidth in the network which results in extended response time. Each user is required to supply more CPU power to view and reject messages that are not addressed to the user.

Excessive network traffic can lead to missing messages and RPI response delay, which may interrupt communication.

It is therefore recommended to use several switches to split the network into several segments. By doing so and the appropriate choice of RPI time and switches, high-speed networks can be decoupled from non-time-critical systems.



INFO

Consider Managed Switch for network segments with data traffic that is not related to the IO-Link segment.

Managed switches are recommended for high-speed control systems of medium or any size. In multicast traffic management, the switch must support IGMP snooping function (Internet Group Management Protocol). Connecting a control system to a large factory or company network typically requires a virtual LAN switch function or routers.

Unicast connections

The device can establish data connections via unicasting. Unicasting can reduce data traffic in the network. Please select the best connection according to your application.

4.3.2 Requested Packet Interval (RPI)

EtherNet/IP system setup requires duly setting the scanner to the RPI value.

According to the manufacturer, this value can range from 1 ms to several 100 ms.

The RPI value defines the scanner speed in EtherNet/IP message transfer (packages).

It also defines the maximum speed in bus node message transfer.

The value defined in the scanner is transmitted to the device when establishing connection, this way system operation utilizes the same time basis.

Further to speed setting for data updates, the RPI value also defines the speed at which the scanner will expect timely reception.

A RPI time too low will automatically generate higher network load.

Higher network load means it will take device more time for processing the request.

This applies also to messages not addressed to the device since these must be accepted and rejected the same way.

This may lead to overload and the device being no longer in a position to execute internal processes, with the consequence that the required RPI time is no longer kept.

Exceeding the set RPI time by factor 4 at least when receiving a telegram, the control will interrupt I/O communication and switch to error state.

Important:

- To ensure proper operation, every configuration with RPI times of less than 10 ms must be tested in advance.
- The minimum supported RPI time is 1 ms!



INFO

For further information please see chapter 8.3 "Requested Packet Interval (RPI) configuration".

4.3.3 Device Level Ring (DLR)

Device Level Ring (DLR) is a protocol enabling media redundancy in ring topologies, e.g. Ether-Net/IP™.

A ring network topology consists of at least one ring supervisor and any number of users.

There are two options to set up topology and to identify line breaks in ring networks:

- Beacon-Based
- Announce-Based

Users supporting DLR must implement the DLR object (0x47), which provides the configuration and diagnostic methods.



INFO

The devices of the present instruction support Beacon-Based DLR technology.

The mentioned devices **do not** support a ring supervisor function and therefore cannot be used as a ring supervisor.



INFO

For further information see chapter 8.4 "Device Level Ring (DLR) configuration".

4.4 Industrial Internet of Things (IIoT)

The device supports the following IIoT functions for industrial communication: *JSONMQTT* and OPC UA.

Also see about this

 [OPC UA \[▶ 60\]](#)

5 Technical data

5.1 Electrical Data

Bus data		
Fieldbus protocol		<i>EtherNet/IP</i>
Connection		4-pin M12, D- coded
Ethernet		10/100 Mbit/s
Addressing		BOOTP, DHCP, WebUI, rotary switch coded
Connection types		Exclusive Owner, Listen Only, Input Only
Device Level Ring (DLR)		Beacon based

IO-Link		
Operating voltage IO-Link devices		24 V □
Voltage range IO-Link devices		20 ... 30 V □
Transmission rate		COM1 / COM2 / COM3
Standardized Master Interface (SMI)		According to IO-Link Specification V1.1.3
Transmission rate recognition		Automatic

Supply		
Operating voltage US		24 V □
Voltage range US		18 ... 30 V □
	When using IO-Link	20.3 ... 30 V □
Operating voltage UA		24 V □
Voltage range UA		18 ... 30 V □
Sensor current US	≤40 °C (see Derating)	≤16 A
Actuator current UA	≤40 °C (see Derating)	≤16 A
Current consumption	At idle	≤0,18 A
Protection against reverse polarization for US and UA		Yes
Reverse polarity protection		Yes
Connection		5-pin M12, L-coded
Conductor cross-section	Current per supply ≤12 A	≥1.5 mm ²
	Current per supply >12 A	≥2.5 mm ²

Input (DI)		
Sensor supply +	Per port, ≤40 °C (see Derating)	≤2 A load Automatic start
Total current sensor supply	≤40 °C (see Derating)	≤10 A
Filter time		0 ... 15 ms + t _{cycle} , adjustable
Delay time at changed signal		2 ... 5 ms
Input characteristic	EN 61131-2	Type 1 + Type 3

Input (DI)		
Short-circuit protection sensor supply		MOSFET with current measurement
Connection		5-pin M12, A-coded
Cable cross-section M12		≤0.75 mm ²
Cable length		≤30 m
Total current	Per port	≤4 A
Output (DO)		
Output current DO (UA)	Per pin, ≤40 °C (see Derating)	≤2 A
Total current outputs	≤40 °C (see Derating)	≤10 A
Switching frequency		≤50 Hz
Short-circuit protection actuator		MOSFET with current measurement
Connection		5-pin M12, A-coded
Cable cross-section M12		≤0.75 mm ²
Cable length		≤30 m
Total current	Per port	≤4 A

Derating sensor current US/ actuator current UA

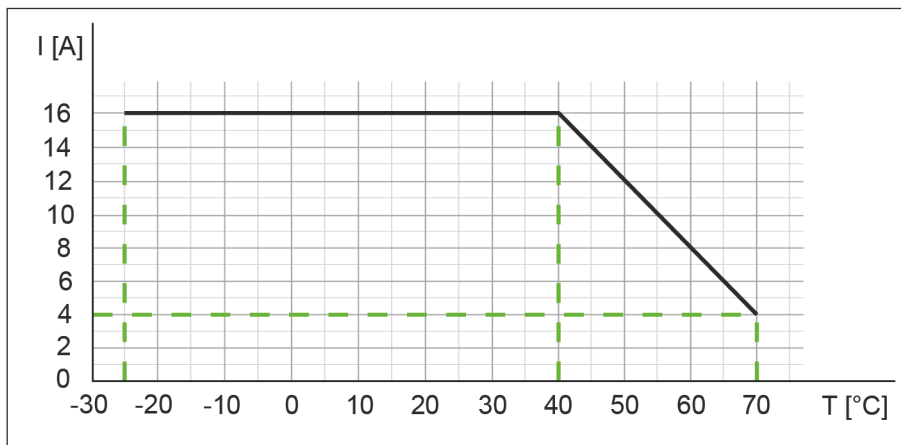

/// 3: Derating sensor current US/ actuator current UA

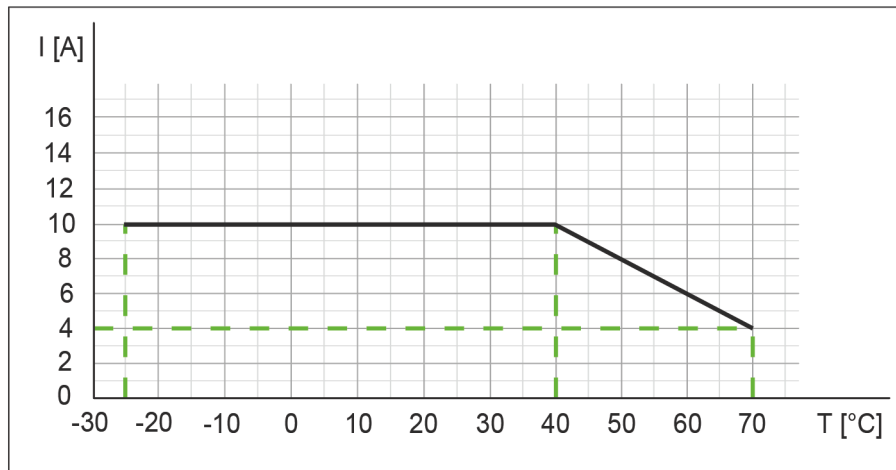
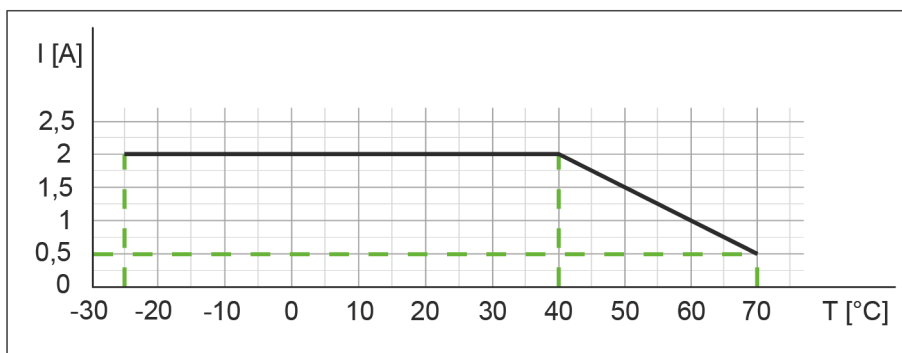
Derating total current, sensor power supplies/outputs total current*III. 4:* Derating total current, sensor power supplies and total current, outputs**Derating current per sensor supply/output***III. 5:* Derating current per sensor power supply and output

5.2 Ambient conditions

Climate		
Operating temperature		-25 °C ... +70 °C
Storage temperature	Ensure acclimatization for commissioning	-25 °C ... +85 °C
Transport temperature	Ensure acclimatization for commissioning	-25 °C ... +85 °C
Relative humidity		≤95 %
Installation height	Above sea level	≤3000 m
Mechanical		
Oscillation test	EN 60068 Part 2-6	10 ... 58 Hz, amplitude 0.35 mm, 58 ... 150 Hz; 20 g
Shock test	EN 60068 Part 2-27	50 g for 11 ms
Electrical safety		
Protection	EN 60529	IP67
Protection rating	Using a SELV- or PELV-power supply	III
Level of contamination		2
EMC emission		
Radiated interference E-field housing enclosure	EN 55016-2-3	Compliant
EMC-immunity		
Electrostatic discharge (ESD)	EN 61000-4-2	Compliant
Electromagnetic RF-fields	EN 61000-4-3	Compliant
Fast transient burst	EN 61000-4-4	Compliant
Shock tension surge	EN 61000-4-5	Compliant
Conducted RF-fields	EN 61000-4-6	Compliant
Voltage dips	EN 61000-4-11	Compliant

5.3 Protection

Device protection		
Overvoltage protection		Yes
Overload protection device supply	To be ensured by load circuit monitoring	Yes
Inverse-polarity protection device supply		Yes
Short-circuit protection sensor supply		Electronically
Short-circuit protection output		Electronically
Protective circuit input	Internal	Suppressor diode

5.4 Mechanical data

Material data		
Housing material		Plastic
Mounting data		
Weight	Net	470 g
Dimensions	L x W x H	225,4 x 63 x 36 mm

5.5 Conformity, Approvals

Conformity, Approvals		
Product standard	EN 61131-2 Programmable Logic Controllers Part 2	Compliant
CE	2014/30/EU 2011/65/EU	Compliant
UKCA		Compliant
EMC	2014/30/EU	Compliant
REACH	No. 1907/2006	SVHC List
WEEE	2012/19/EU	Compliant
ULus		E201820
RoHS	2011/65/EU & 2015/863	Exception 6c&7a
China RoHS	SJ/T 11364-2014	25 EPUP

Hazardous substance (有害物質)							
	Part Name	Lead	Mercury	Cadmium	Hexavalent	Polybrominated	Polybrominated
	零件名稱	(Pb) 鉛	(Hg) 汞	(Cd) 鎘	Chromium (Cr (VI)) 六价铬	biphenyls (PBB) 多溴联苯	diphenyl ethers (PBDE) 多溴联苯醚
	Component part PCB 组件部分 印刷电路板	X	O	O	O	O	O
	Connection Terminal/ Screws 接线端子 / 拧	X	O	O	O	O	O
<p>O: Indicates that the content of the harmful substance in all homogeneous materials of the component part is below the limit defined in GB/T 26572.</p> <p>O: 表明該有害物質在組成部分的所有均質材料的含量低於按GB/ T26572定義的限制。</p> <p>X: Indicates that the content of the harmful substance in at least one homogeneous material of the component part exceeds the limit defined in GB/T 26572.</p> <p>X: 表示該有害物質在組成部分中的至少一個均質材料的含量超過按GB / T26572定義的限制。</p>							

6 Installation

6.1 Requirements

Installation requirements:

- Even mounting surface to avoid mechanical tension.
- Provide proper grounding.
- Suitable installation site in terms of vibration and shock load, temperature and humidity (see Technical data).
- Protected site to prevent connection cables from being torn off accidentally.

6.2 Dimensions

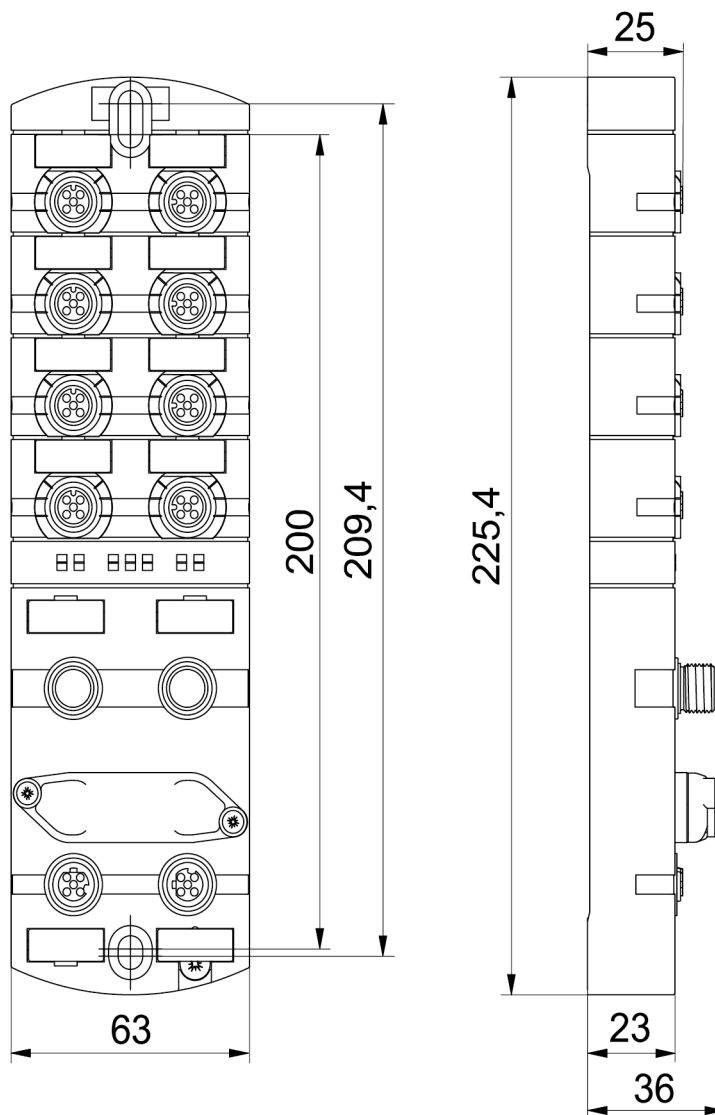

///. 6: Dimensions in mm

6.3 Mounting distance

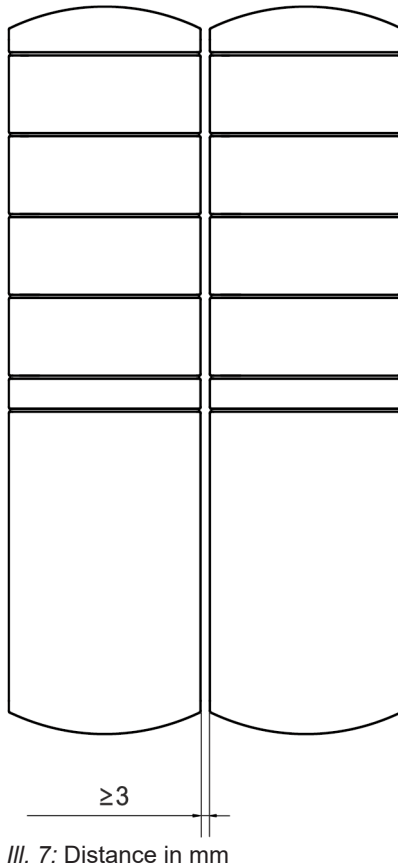
**INFO**

For proper installation and improved heat dissipation, we recommend maintaining a minimum distance of 3 mm when installing *CM50I*.

**INFO**

Minimum distance of 50 mm required where using angled connectors.

6.4 Mounting the device



⚠ WARNING

Material damage due to incorrect installation.

Use fastening screws that are appropriate for the mounting surface.

- a) Fastening screws and tightening torques depend on mounting surface.
- b) Tighten the screws carefully. Observe the specified tightening torques.



⚠ WARNING

Material damage through improper use.

Do not use the devices as climbing aids. Devices may come off by improper use or might be damaged.

- a) Install the device in such a way that it cannot be used as climbing aid.

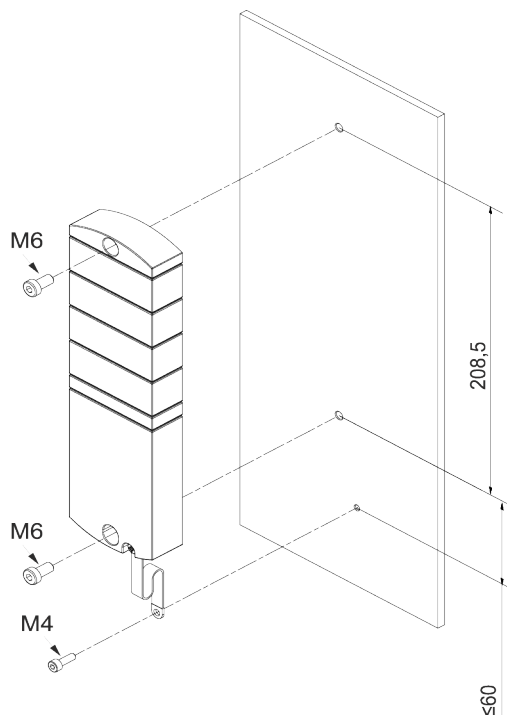

Ill. 8: Fasten the device. Dimensions in mm (illustration similar)

M6	3 Nm		Art.-No. 7000-98001-0000000
----	------	---	--------------------------------

When mounting the device, observe the order indicated below:

- a) Slightly tighten the top M6 screw.
- b) Align the housing.
- c) Slightly tighten the lower M6 screw.
- d) Tighten both M6 screws to the specified torque.
- e) *Device grounding*: Attach grounding strap (see [Functional ground \[▶ 24\]](#)).



INFO

The screws and grounding strap of the illustration are not included in the delivery.

6.4.1 Functional ground



INFO

Use a conductive screw to attach the grounding strap.

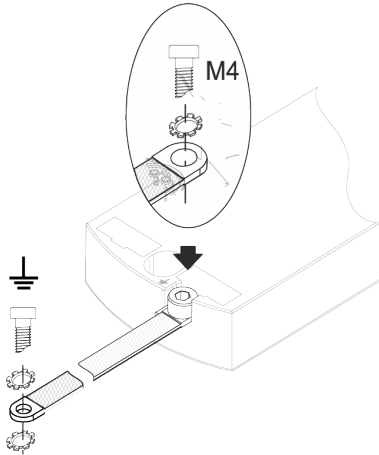

III. 9: Attach the grounding strap

Tool

- ● M4
- ◆ Tighten the screw at 1.2 Nm \pm 0.1 Nm.



INFO

The screws and grounding strap of the illustration are not included in the delivery. The grounding strap is available at the Baumer Website <http://baumer.com>.

Also see about this

📄 [Accessories](#) [▶ 122]

6.4.2 Addressing lid

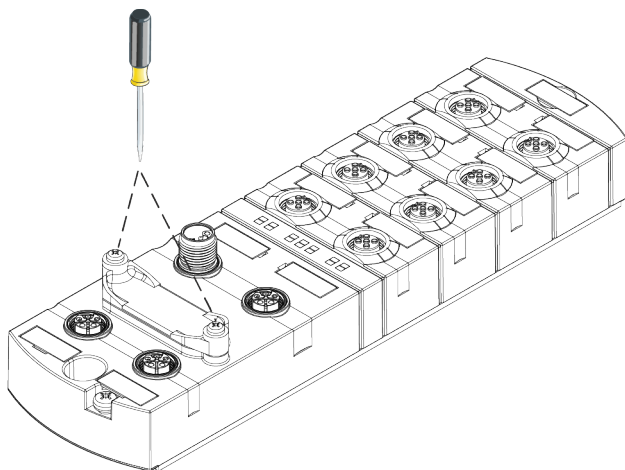

III. 10: Attaching the addressing lid

Tool

- ● M3

Instruction:

- ◆ Tighten the screws at 0.8 Nm \pm 0.1 Nm fest.

7 Installation

7.1 Electrical installation of the device

DANGER

High electrical voltage in the machine/system.

Death or severe injuries resulting from electric shock.

- a) While working on the machine/devices, comply with the five safety rules of electrical engineering.

Protection of persons and material assets

- In accordance with *DIN VDE 0105-100 - Operation of electrical installations - Part 100: General requirements*

WARNING

Risk of fire due to short circuit.

Supply lines and/or devices may short circuit when damaged causing overheating and fire.

- a) Ensure smart current monitoring or fuse
The fuse must be able to hold max. 9 A.

CAUTION

Loss of function due to improper installation.

Failure to observe may result in personal injury and/or damage to property.

- a) Only use cables and accessories compliant to the requirements and relevant regulations for safety, electromagnetic compatibility and, if required, telecommunication end devices and specifications.



CAUTION

Hot surface.

Minor personal injuries and damage to the device when contacting hot surfaces.

- a) Wear suitable isolating gloves.
- b) Only use connection cables that meet thermal requirements.

CAUTION

Damage to machine/system by improper voltage on/off.

Switching on the device by separate actuator and sensor voltage, the functions of the digital inputs and outputs cannot be guaranteed.

- a) For device switch-on observe the following order:

- a) Switch on sensor voltage.
- b) Switch on actuator voltage.



INFO

Only use a power unit capable of limiting voltage to max. 60 VDC resp. 25 AC at the occurrence of error. Power supply must comply with SELV or PELV.

7.1.1 Rotary switch settings

**INFO**

Factory defaults: Rotary switches position is **000**, DHCP enabled.

**INFO**

An unambiguous and unique IP address must be assigned to each user in the network.

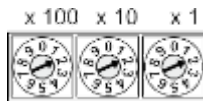
**Address range 1 ... 999**

x1	Rotary switch (units)
x10	Rotary switch (tens)
x100	Rotary switch (hundreds)

Tab. 1: Rotary switch for addressing

Position/ area	Web server	JSON	OPC UA	MTQQ	Description	
0	– *	– *	– *	– *	Out of the box: DHCP	Previously saved interface configuration: Saved configuration is applied.
1 ... 254	– *	– *	– *	– *	Last octet	Set the fourth octet of the IP address using the rotary switch value. Preset: 192.168.0.xxx
255	– *	– *	– *	– *	Static IP address	The last saved IP address is active.
256 ... 910	– *	– *	– *	– *	Reserved *	
911	Disabled	Disabled	Disabled	Disabled	Secure Mode	Fieldbus communication in standard operation
912	– *	Disabled	Disabled	Disabled	IIoT mode disabled	
913	Disabled	Disabled	– *	– *	Web server disabled	
914	Enabled	Enabled	Enabled	Enabled	Enables all IIoT protocols and web server.	
915-978	– *	– *	– *	– *	Reserved	
979	Enabled	Enabled	Enabled (up to FWV1.05) disabled (from FWV1.06)	Enabled (up to FWV1.05) disabled (from FWV1.06)	Restore default	Sequence of actions only for this rotary switch position: <ol style="list-style-type: none"> 1. Disconnect device from power supply. 2. Set switch to position 979. 3. Connect device to power supply. 4. Wait until reset is completed. 5. Disconnect device from power supply. <p><i>ST LED flashing green: Device is performing reset.</i></p> <p><i>ST LED is on green continuous: Reset completed.</i></p>

Position/ area	Web server	JSON	OPC UA	MTQQ	Description
					6. Set switch to position 000 or any other required position. 7. Connect device to power supply.
980-999	- *	- *	- *	- *	Reserved *

* Last protocol setting is retained.



INFO

Reserved switch positions do not enable fieldbus communication, see [LED indicator](#) [▶ 69].

Service settings

Switch positions 911, 912 and 913 disable the device services marked in the "set address" matrix. With these settings, the switching behaviour of the device is according to the previous address configuration without limiting any functions, except the services disabled by this switch position. The services disabled by doing so could not be re-enabled in any other way, e.g. via the control's configuration parameters.

Switch position 914 will enable all services again. Again, the device functionalities are not limited.

1. Connect device to power supply.
2. Disconnect supply.
3. Set original address.



INFO

Saved default IP address is 192.168.0.6.



INFO

IP address parameters will be saved in any switch position. This is particularly important when setting the switch 0.

Setting the address

Setting the address

1. Disconnect device from supply.
2. Remove addressing lid.
3. Set an address which is unique.
4. Fasten addressing lid again.
5. Connect device to power supply.



INFO

For appropriate tightening torque see [Addressing lid](#) [▶ 24].

7.1.2 Sensors and actuators

Connection of M12 female connector

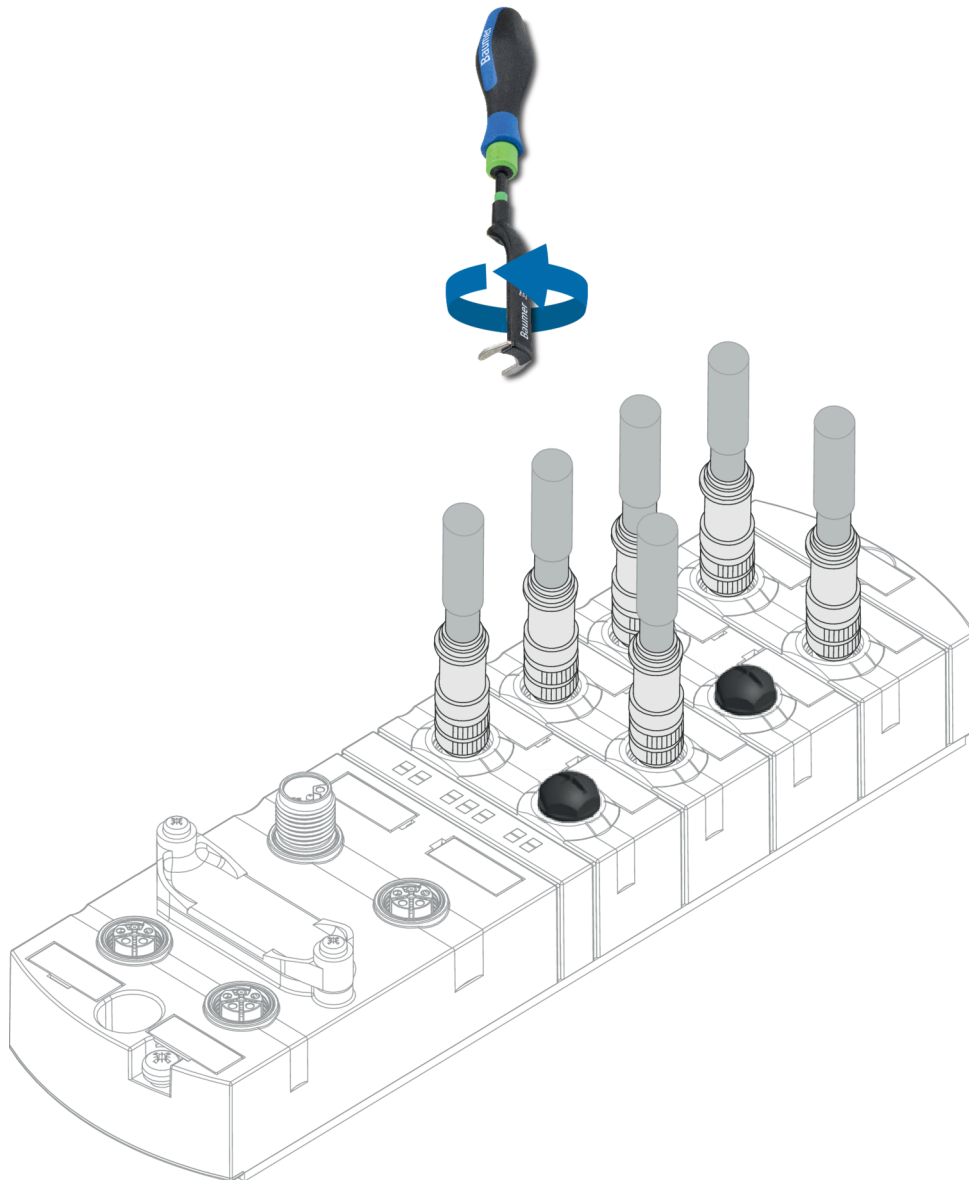
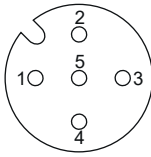

III. 11: Example of M12 connection inputs and outputs

M12	0.6 Nm		Art.-No. 7000-99102-000000
-----	--------	--	-------------------------------

**INFO**

Feeding external ground via M12 female connectors may lead to errors.

- a) Do not feed external ground into the device via the M12 female connectors.

**INFO**

Maximum length of sensor and actuator cables is limited to 30 m.

Sensor supply**Important:**

- Sensors supply is via **pin 1** (24 V) and **pin 3** (0 V) of the M12 female connectors.
- The maximum permissible current for supplying the sensors is **2 A** per M12 socket.
- In the event of overcurrent or short circuit, **disconnect** supply cable resp. sensor from the M12 female connector.

Supported IO-Link communication

The device supports IO-Link communication at the following rates:

- 4.800 Baud (COM 1)
- 38.400 Baud (COM 2)
- 230.400 Baud (COM 3)

**INFO**

The device would automatically select the communication rate appropriate for the related IO-Link device.

**INFO**

Maximum cable length for IO-Link communication is 20 m.

**INFO**

A large selection of connection cables can be found on the Baumer website <https://www.baumer.com>.

7.1.3 Connecting the EtherNet/IP network

Connection of M12 female connector

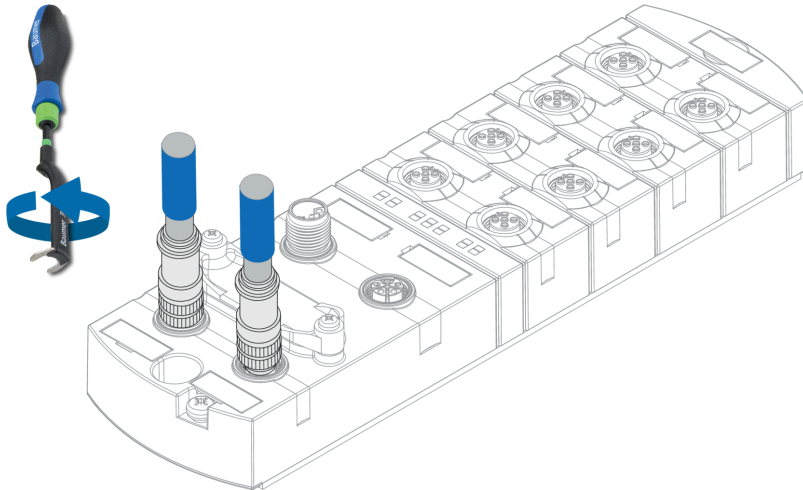
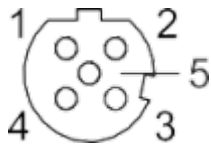

III. 12: Example of M12 connection (EtherNet/IP Bus)

M12	0.6 Nm		Art.-No. 7000-99102-000000
-----	--------	--	-------------------------------

Also see about this

[Pin assignment](#) [9]

7.1.4 Power supply

Connection with M12

POWER IN

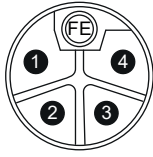

POWER OUT

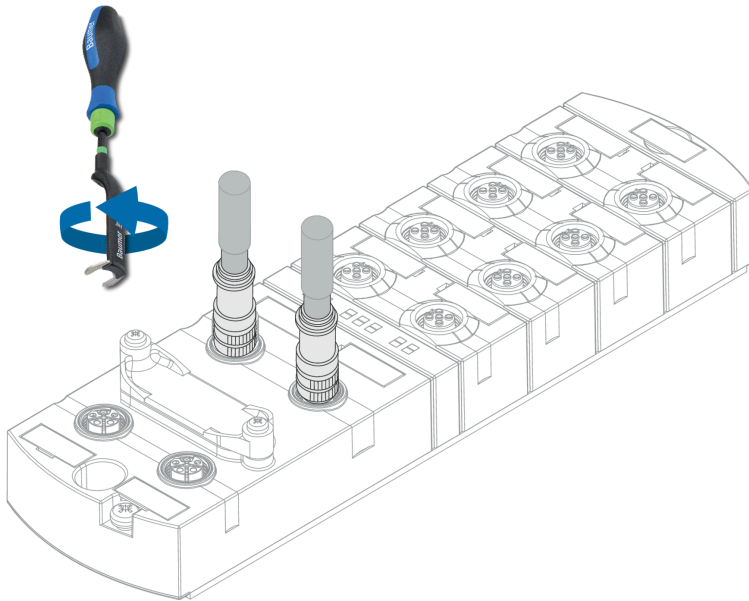
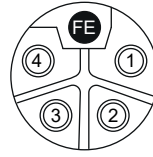

III. 13: Example of M12 connection (POWER)

M12	0.6 Nm		Art.-No. 7000-99102-000000
-----	--------	--	-------------------------------



INFO

A large selection of connection cables can be found on the Baumer website <https://www.baumer.com>.

7.2 Ensuring Tightness (IP67)

⚠ CAUTION

Leaky housing.

Risk of personal injury and material damage due to failure caused by ingress of conductive liquids.

- a) Seal any male and female connectors not in use.

Cable connection



III. 14:

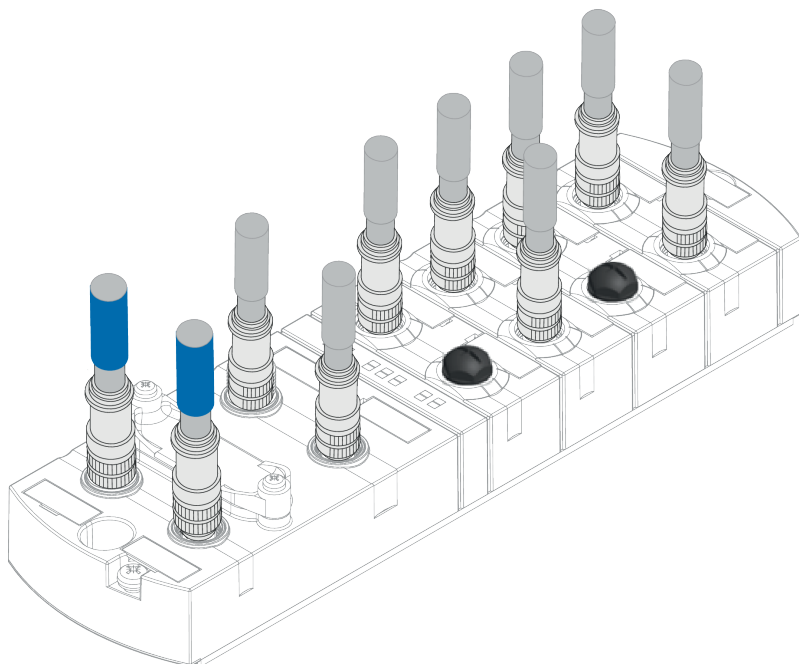

III. 15: Cable connection

M12	0,6 Nm		Art.-No. 7000-99102-000000
-----	--------	--	-------------------------------



INFO

A large selection of connection cables can be found on the Baumer website <https://www.baumer.com>.

8 Commissioning

WARNING

Risk of burns.

Prohibited to separate or establish electrical connection during operation. Failure to observe this warning may result in electric arcs that can cause burns.

- a) Disconnect device from power supply.

CAUTION

Uncontrolled processes.

Personal injury and material damage due to incorrect commissioning (initial commissioning, device restart or change in device configuration).

- a) Commissioning should always observe the order below:

- a) Insert the device.
- b) System check and approval by an expert.
- c) Put into operation.

CAUTION

Functional errors in residential areas.

Devices of EMC Class A may cause interference in residential areas.

- a) The system operator must take appropriate measures.

8.1 EDS file import

Tool used

Device configuration and parameterization in this chapter uses the example of Studio5000 Logix-Designer from Rockwell Automation Germany.

Installation of EDS file or device description file

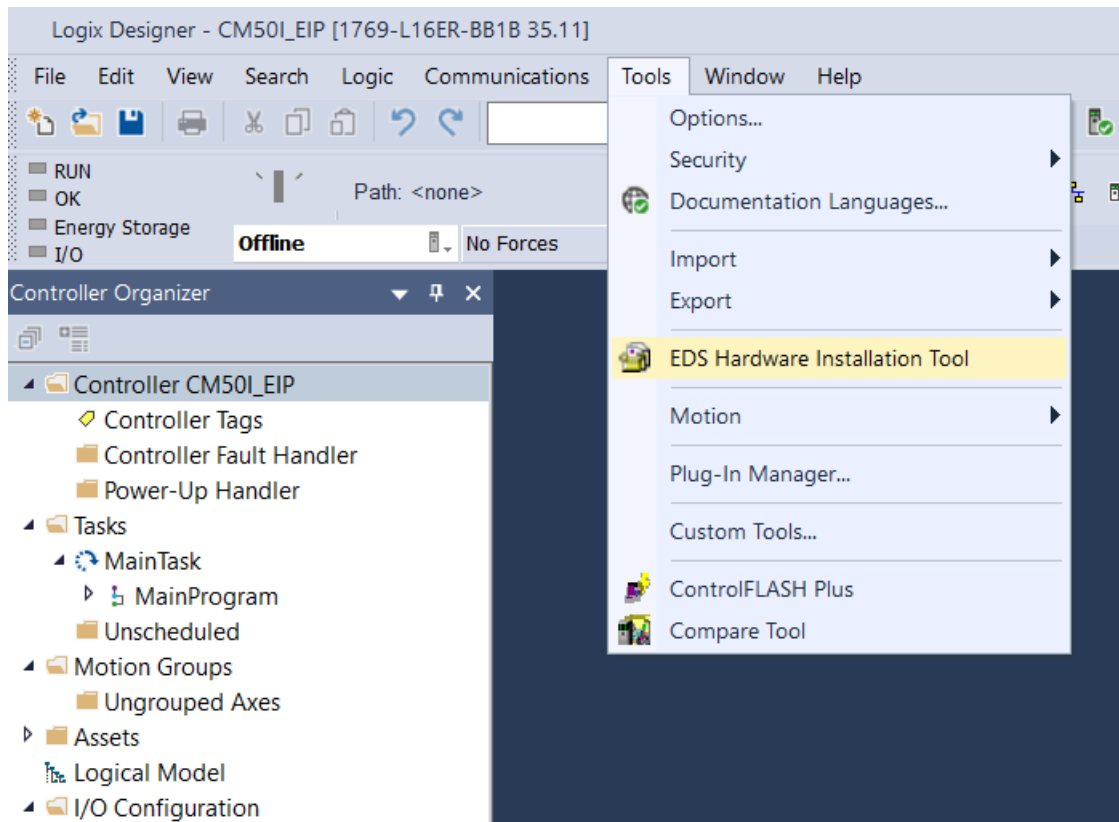

III. 16: EDS file Import



INFO

The ESD file is accessible at the Baumer website <https://www.baumer.com> in the download area under the device article number.

- ♦ .In **Project Menu | Tools** select , **EDS Hardware Installation Tool**.

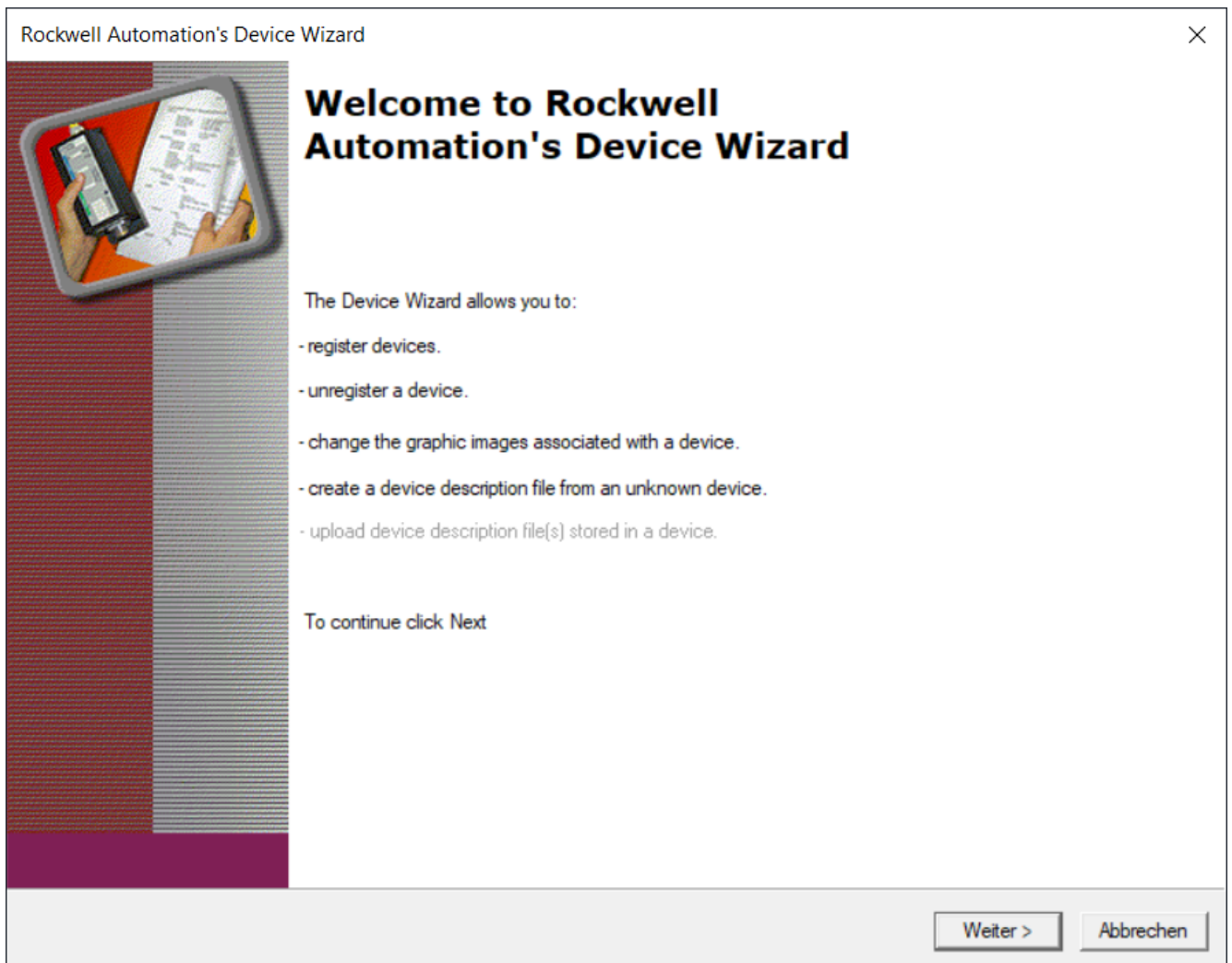

III. 17: EDS Wizard

- a) Click **Next** and follow the dialog instructions.
- b) Complete EDS file installation.

Result:

- ✓ Now the devices are available for selection and can be added to the network.

8.2 Adding a device to the network

Add New Module

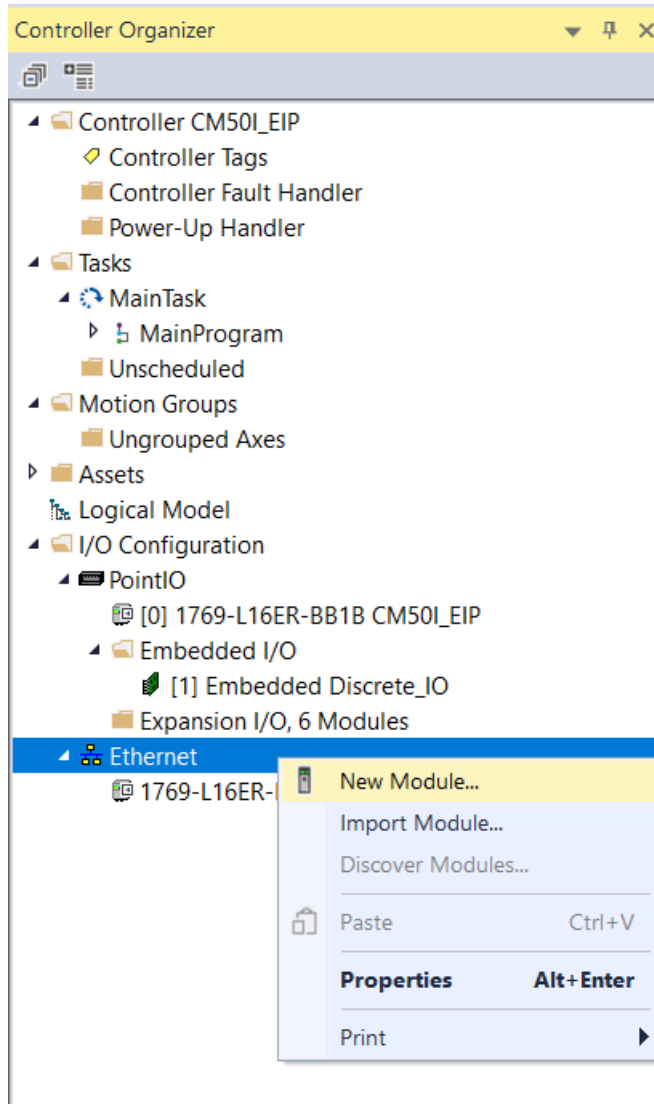

III. 18: New Module

Instruction:

- ◆ Select **New Module** in **Controller Organizer | Ethernet**.

The dialog window provides the devices

- previously registered with EDS *or*
- were supplied with the engineering software installed.

Alternative module selection

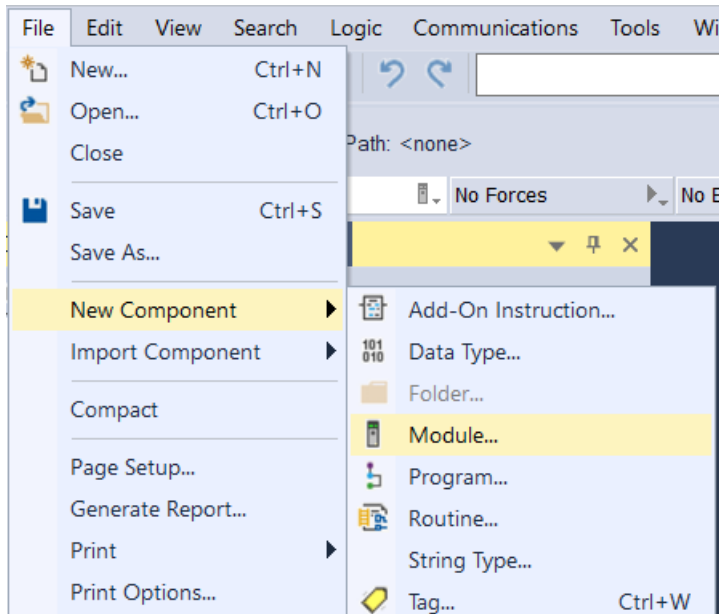

III. 19: Alternative module selection

- ◆ Alternatively, call up the dialog window via the menu bar using **Files/New Component/Module**.

Search device

Search the input screen for the device to be added to the network.

- As search terms use terms describing the device,
- e.g. product number, product name or manufacturer. Select filters from the dialog window.

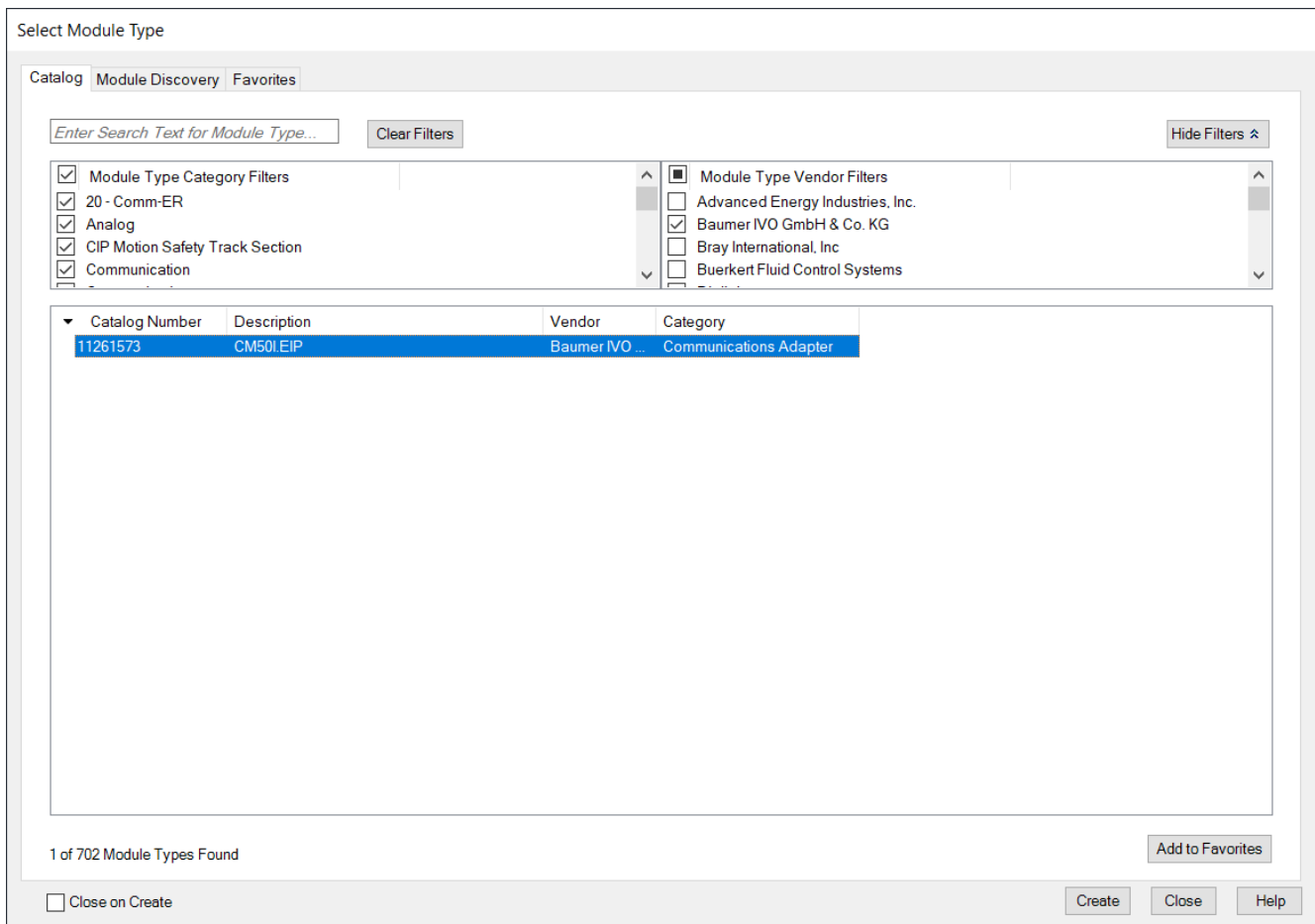

III. 20: Search device

- Mark the device.
- Double-click on **Create**.

General settings

The screenshot shows the 'New Module' dialog box with the 'General' tab selected. The left sidebar contains a tree view with 'General' selected. The main area is divided into several sections:

- General:**
 - Type: 11261573 CM50I.EIP
 - Vendor: Baumer IVO GmbH & Co. KG
 - Parent: Local
 - Name: [Empty text box]
 - Description: [Empty text area]
- Ethernet Address:**
 - Private Network: 192.168.1. [Spin box]
 - IP Address: [IP address input box]
 - Host Name: [Host name input box]
- Module Definition:**
 - Revision: 1.003
 - Electronic Keying: Compatible Module
 - Connections: E02 - Digital In/Output + IO...

At the bottom right, there are buttons for 'OK', 'Cancel', and 'Help'. At the bottom left, the status is 'Status: Creating'.

III. 21: General settings

- a) Assign a unique device name in **New Module | General**.
- b) Assign IP address.
- a) Enter more settings In **New Module | Connection**, e.g. RPI values.
- b) Add device to network with **OK**.

Select connection

You can select between various connection options the one matching your application best:

- select the connection straight when adding the device to the network or
- double-click on the device to call up the settings again.

Module Definition

Revision: 1 003

Electronic Keying: Compatible Module

Connections:

Name	Input	Output	Size
E02 - Digital In/Output + IO-Link(32B) + State/Diag	394	260	SINT

OK Cancel Help

III. 22: Module definition

- Click on **Change** in **Module Definition**.
 - ✓ A dialog window opens.
- Enter the settings for number or type of connection.
- Click on the default connection (**Exclusive-Owner**).
- Select connection that is best appropriate.

Result:

- ✓ You are provided with a list of the possible connections.



INFO

The devices support up to 3 connections in parallel (1 Exclusive Owner and 2 Non-Exclusive Owner).

8.3 Commissioning without EDS

8.3.1 Connection, parameters and properties



INFO

Listen only connections are only established as multicast and only to multicast non-listen connections of category **via EDS**.

This will define the configuration instance to be used in the instance applied to the non-listen-only connection.

8.3.2 Connection matrix

Configuration Assembly				Description	Input Assembly		Output Assembly	
via EDS		via web server			Instance	Length	Instance	Length
Instance 170	Length xxx	Instance 171	Length 0					
E02		WE02		Digital I/O's, IOL 32 bytes with status and diagnos- tics	101	394	111	259

Tab. 2: Exclusive owner connection

Configuration Assembly				Description	Input Assembly		Output Assembly	
via EDS		via web server			Instance	Length	Instance	Length
Instance 170	Length xxx	Instance 171	Length 0					
I02		WI02		Digital I/O's, IOL 32 bytes with status and diagnos- tics	101	394	193	259

Tab. 3: Input only connection

Connection name	Description	Input Assembly		Output Assembly	
		Instance	Length	Instance	Length
L02	Digital I/O's, IOL 32 bytes with status and diagnostics	101	394	192	259

Tab. 4: Listen Only connection

8.3.3 Assemblies

Configuration byte sequence

Parameter	Instance 170	Instance 171
Total size in bytes	384	0
General information	0 ... 1	
Diagnostic tools	2 ... 19	
IO-Link Port X0	20 ... 43	
IO-Link Port X1	44 ... 67	
IO-Link Port X2	68 ... 91	
IO-Link Port X3	92 ... 115	
IO-Link Port X4	116 ... 139	
IO-Link Port X5	140 ... 163	
IO-Link Port X6	164 ... 187	
IO-Link Port X7	188 ... 211	
OPC/UA	212 ... 217	
MQTT	218 ... 379	
WebUI	380 ... 381	
JSON	382 ... 383	

Tab. 5: Assembly instance 170/171

Input byte sequence

Parameter	Instance 101
Total size in bytes	394
Digital input DI	0 ... 1
DI Qualifier	2 ... 5
System status	6 ... 9
IO-Link port X0 Input data	10 ... 41
IO-Link port X0 Input status	42 ... 49
IO-Link port X1 Input data	50 ... 81
IO-Link port X1 Input status	82 ... 89
IO-Link port X2 Input data	90 ... 121
IO-Link port X2 Input status	122 ... 129
IO-Link port X3 Input data	130 ... 161
IO-Link port X3 Input status	162 ... 169
IO-Link port X4 Input data	170 ... 201
IO-Link port X4 Input status	202 ... 209
IO-Link port X5 Input data	210 ... 241
IO-Link port X5 Input status	242 ... 249
IO-Link port X6 Input data	250 ... 281
IO-Link port X6 Input status	282 ... 289

Parameter	Instance 101
Total size in bytes	394
IO-Link port X7 Input data	290 ... 321
IO-Link port X7 Input status	322 ... 329
Buffer diagnosis	330 ... 393

Tab. 6: Assembly instance 101

Output byte sequence

Parameter	Instance 111
Total size in bytes	260
Digital output	0 ... 1
IO-Link port X0 Output data	2 ... 33
IO-Link port X1 Output data	34 ... 65
IO-Link port X2 Output data	66 ... 97
IO-Link port X3 Output data	98 ... 129
IO-Link port X4 Output data	130 ... 161
IO-Link port X5 Output data	162 ... 193
IO-Link port X6 Output data	193 ... 225
IO-Link port X7 Output data	226 ... 257
Diagnostics confirmation	258 ... 259

Tab. 7: Assembly instance 111

8.3.4 Configuration values



INFO

Unexpected device behavior.

- a) Only use the values listed here.

General parameters

Byte	Parameter	Value	Default value	Description
0	Pin/Port based IO layout for digital channels	IO Layout: <ul style="list-style-type: none"> ■ 0 = Port based ■ 1 = Pin based 	0	Parameterization of I/O data layout.

Tab. 8: General parameters

Diagnostic parameters

Byte	Parameter	Value	Default value	Description
0	Global Diagnostic Report	<ul style="list-style-type: none"> ■ 0 = Disabled ■ 1 = Enabled 	1	Report global diagnoses
1	Under Voltage Sensor Supply Diagnostic Message	<ul style="list-style-type: none"> ■ 0 = Do not report ■ 1 = Report 	1	Diagnostic message undervoltage US

Byte	Parameter	Value	Default value	Description
2 - 3	Under Voltage Sensor Supply Threshold	<ul style="list-style-type: none"> ■ 0 = Default ■ 17500 = 17.5 V 18.0 V ■ 18000 = 18.0 V 18.5 V ■ 18500 = 18.5 V 19.0 V ■ 19000 = 19.0 V 19.5 V ■ 19500 = 19.5 V 20.0 V 	0	Threshold value US for undervoltage
4	Under Voltage Actuator Supply Diagnostic Message	<ul style="list-style-type: none"> ■ 0 = Do not report ■ 1 = Report 	1	Diagnostic message undervoltage UA
5 - 6	Under Voltage Actuator Supply Threshold	<ul style="list-style-type: none"> ■ 0 = Default ■ 17500 = 17.5 V 18.0 V ■ 18000 = 18.0 V 18.5 V ■ 18500 = 18.5 V 19.0 V ■ 19000 = 19.0 V 19.5 V ■ 19500 = 19.5 V 20.0 V 	0	Threshold value UA for undervoltage
7	No Actuator Supply Diagnostic Message	<ul style="list-style-type: none"> ■ 0 = Do not report ■ 1 = Report 	1	Diagnostic message no UA
8	LED Indication For Suppressed Diagnostic Messages	<ul style="list-style-type: none"> ■ 0 = No LED indication ■ 1 = LED indication 	0	LED display for suppressed diagnostic messages
9	Diagnostic Message Acknowledgement	<ul style="list-style-type: none"> ■ 0 = Disabled ■ 1 = Enabled 	0	Confirmation of the diagnostic message
10	Port X0 Diagnostic Report	<ul style="list-style-type: none"> ■ 0 = Report All Diagnostic Messages ■ 1 = Report All Diagnostic Messages Except For Wire Break ■ 2 = Report Only Wire Break Diagnostic Messages 	0	Port X0 diagnostic report
11	Port X1 Diagnostic Report	<ul style="list-style-type: none"> ■ 0 = Report All Diagnostic Messages ■ 1 = Report All Diagnostic Messages Except For Wire Break ■ 2 = Report Only Wire Break Diagnostic Messages 	0	Port X1 diagnostic report
12	Port X2 Diagnostic Report	<ul style="list-style-type: none"> ■ 0 = Report All Diagnostic Messages ■ 1 = Report All Diagnostic Messages Except For Wire Break 	0	Port X1 diagnostic report

Byte	Parameter	Value	Default value	Description
		<ul style="list-style-type: none"> ▪ 2 = Report Only Wire Break Diagnostic Messages 		
13	Port X3 Diagnostic Report	<ul style="list-style-type: none"> ▪ 0 = Report All Diagnostic Messages ▪ 1 = Report All Diagnostic Messages Except For Wire Break ▪ 2 = Report Only Wire Break Diagnostic Messages 	0	Port X3 diagnostic report
14	Port X4 Diagnostic Report	<ul style="list-style-type: none"> ▪ 0 = Report All Diagnostic Messages ▪ 1 = Report All Diagnostic Messages Except For Wire Break ▪ 2 = Report Only Wire Break Diagnostic Messages 	0	Port X4 diagnostic report
15	Port X5 Diagnostic Report	<ul style="list-style-type: none"> ▪ 0 = Report All Diagnostic Messages ▪ 1 = Report All Diagnostic Messages Except For Wire Break ▪ 2 = Report Only Wire Break Diagnostic Messages 	0	Port X5 diagnostic report
16	Port X6 Diagnostic Report	<ul style="list-style-type: none"> ▪ 0 = Report All Diagnostic Messages ▪ 1 = Report All Diagnostic Messages Except For Wire Break ▪ 2 = Report Only Wire Break Diagnostic Messages 	0	Port X6 diagnostic report
17	Port X7 Diagnostic Report	<ul style="list-style-type: none"> ▪ 0 = Report All Diagnostic Messages ▪ 1 = Report All Diagnostic Messages Except For Wire Break ▪ 2 = Report Only Wire Break Diagnostic Messages 	0	Port X7 diagnostic report

Tab. 9: Diagnostic parameters

IO-Link-Port X0 ... X7 Parameter

Byte	Parameter	Value	Default value	Description
0	IO-Link Function Pin 4	<ul style="list-style-type: none"> ■ 0 = Deactivated ■ 1 = IO-Link Manual Configuration ■ 2 = IO-Link Autostart ■ 3 = Digital Input NO ■ 4 = Digital Output ■ 97 = Digital Input NC 	0	IO-Link function pin 4
1	Validation&Backup	<ul style="list-style-type: none"> ■ 0 = No Device check ■ 1 = Type compatible Device V1.0 ■ 2 = Type compatible Device V1.1 ■ 3 = Type compatible Device V1.1, Backup + Restore ■ 4 = Type compatible Device V1.1, Restore 	0	Validation and backup, * see Note
2	Behavior Pin 2 (Ch1Y)	<ul style="list-style-type: none"> ■ 0 = Automatic Mode (DIO) ■ 1 = Digital Input ■ 2 = Digital Output ■ 5 = AUX Power ■ 6 = Digital Input NC ■ 7 = Deactivated 	0	Verhalten Pin 2 (Ch1Y)
3	PortCycle-Time	<ul style="list-style-type: none"> ■ 0: As fast as possible ■ 1 - 255: Bit0..5 Multiplier / Bit6..7 TimeBase[ms] 	0	Port cycle time
4 - 5	Vendor ID	Vendor ID of the attached IO-Link device for the use with validation setting	0	
6 - 9	Device ID	Device ID of the attached IO-Link device for the use with validation setting	0	
10	RESERVED		0	Reserved for future use
11	IO-Link Event integration	<ul style="list-style-type: none"> ■ 0 = Standard integration 	0	IO-Link event integration
12	Digital Input Signal Filter Pin 4	<ul style="list-style-type: none"> ■ 0 = No Filter ■ 1 = 1 ms ■ 2 = 3 ms ■ 3 = 5 ms ■ 4 = 10 ms ■ 5 = 15 ms 	0	Digital input signal filter pin 4

Byte	Parameter	Value	Default value	Description
13	Digital Input Signal Filter Pin 2	<ul style="list-style-type: none"> ■ 0 = No Filter ■ 1 = 1 ms ■ 2 = 3 ms ■ 3 = 5 ms ■ 4 = 10 ms ■ 5 = 15 ms 	0	Digital input signal filter pin 2
14 - 15	RESERVED		0	Reserved for future use
16	Digital Port Function Configuration Pin 1	<ul style="list-style-type: none"> ■ 0 = Deactivated ■ 1 = L+ (US) Sensor Supply 	1	Digital connection Function Configuration Pin 1
17	Output Current Limitation for Pin 1	<ul style="list-style-type: none"> ■ 0 = 0.5 A ■ 1 = 1.0 A ■ 2 = 1.5 A ■ 3 = 2.0 A 	3	Output current limitation for pin 1
18	Output Current Limitation for Pin 2	<ul style="list-style-type: none"> ■ 0 = 0.5 A ■ 1 = 1.0 A ■ 2 = 1.5 A ■ 3 = 2.0 A 	3	Output current limitation for pin 2
19	Output Current Limitation for Pin 4	<ul style="list-style-type: none"> ■ 0 = 0.5 A ■ 1 = 1.0 A ■ 2 = 1.5 A ■ 3 = 2.0 A 	0	Output current limitation for pin 4
20 - 23	RESERVED		0	Reserved for future use

Tab. 10: IO-Link-Port X0 ... X7 Parameter

**INFO**

* When switching to the *Restore* status, any device configurations previously saved in the device are discarded, especially when switching from *Backup&Restore* to *Restore*.

If a compatible device is connected for the first time in the *Restore* status, the master retrieves the data storage data (one-off backup) from the device once, saves it and then sends this data to each newly connected, compatible device with a different configuration (*Restore*).

**INFO**

These parameters are repeated for each IO-Link port of the device.

OPC/UA parameters

Byte	Parameter	Value	Default value	Description
0	Use Of OPC/UA	<ul style="list-style-type: none"> ■ 0 = Disabled ■ 1 = Enabled 	0	Activates or disables the OPC/UA Server function

Byte	Parameter	Value	Default value	Description
1 - 2	OPC/UA TCP Port Number	1024 – 49151 TCP port number	4840	Defines on which port the OPC/UA Server is active
3	Allow OPC/UA Clients to Write ISDU Data	<ul style="list-style-type: none"> ■ 0 = Disabled ■ 1 = Enabled 	0	Activates or disables the option to write ISDU data from a OPC/UA client
4	Allow OPC/UA Clients to Write Output Data	<ul style="list-style-type: none"> ■ 0 = Disabled ■ 1 = Enabled 	0	Activates or disables the option to write output data from a OPC/UA client
5	RESERVED		0	Reserved for future use

Tab. 11: OPC/UA parameters

MQTT parameters

Byte	Parameter	Value	Default value	Description
0	Use Of MQTT	<ul style="list-style-type: none"> ■ 0 = Disabled ■ 1 = Enabled 	0	Activates or disables the MQTT function
1 - 4	MQTT Server IP Address	Value of IP MQTT Server IP Address	0xC0AB01FE = 192.171.1.254	Sets the IP address of the MQTT server
5 - 27	MQTT Client ID	Client ID of the MQTT Client	"MqttClient"	Sets the ID which the device shall use to send MQTT data
28 - 91	MQTT Client Head Topic	MQTT Client Head Topic	""	Sets the Head Topic to which the device writes MQTT data
92 - 155	MQTT Topic For System Data	MQTT Topic For System Data	""	Set the topic for system data to which the device writes MQTT data

Tab. 12: MQTT parameters

WebUI parameters

Byte	Parameter	Value	Default value	Description
0	Use Of WebUI	<ul style="list-style-type: none"> ■ 0 = Disabled ■ 1 = Enabled 	1	Activates or disables the WebUI
1	RESERVED		0	Reserved for future use

Tab. 13: WebUI parameters

JSON parameters

Byte	Parameter	Value	Default value	Description
0	Use Of JSON	<ul style="list-style-type: none"> ■ 0 = Disabled ■ 1 = Enabled 	0	Activates or disables the option to send and receive JSON communication
1	RESERVED		0	Reserved for future use

Tab. 14: JSON parameters

9 Configuration and parameterization

WARNING

Device protection function impaired by changed device configuration.

- a) Only authorized persons may change configuration.
- b) When changing the configuration, use the password hierarchy provided by your engineering software.
- c) After every change in configuration, check proper activity of the safety equipment.

9.1 Configuration

Overview

There are two options for device configuration.

- On the one hand, an EDS file is available for download on the Baumer website.
 - These can be imported into the programming software as described in the chapter *Importing the EDS files* in order to then use the benefits of the preconfigured connections.
- Second: Device configuration via the integrated web server.



INFO

To adopt index changes made via Webserver and via acyclic ISDU into DataStorage, a *ParamDownloadStore Command* must be transmitted after the index change.

- a) The *ParamDownloadStore Command* can be triggered by writing value $0x05$ to index $0x02$.

Configuration via EDS

After having imported the EDS file into the programming software and having selected the application-appropriate connection, the configuration files can be seen in the controller tags.

Right next are the input and output tags assigned to the device.

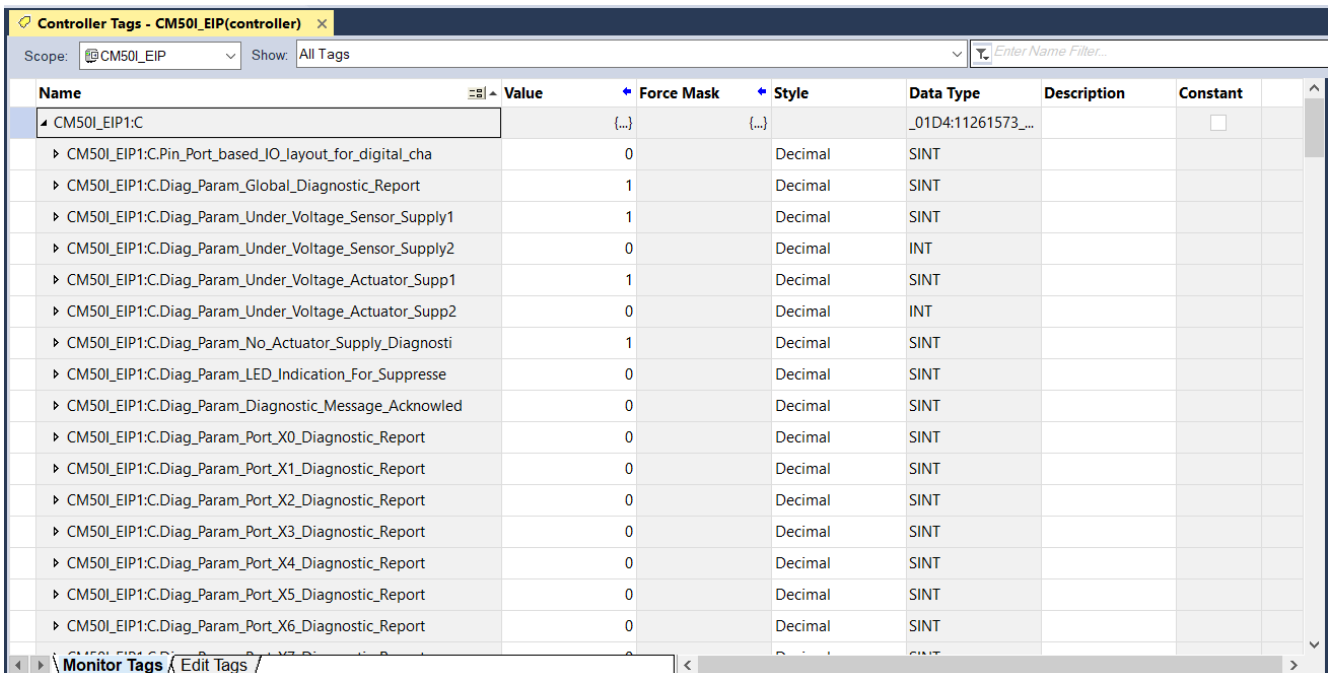

Name	Value	Force Mask	Style	Data Type	Description	Constant
CM50I_EIP1:C	{...}		{...}	_01D4:11261573_...		<input type="checkbox"/>
CM50I_EIP1:C.Pin_Port_based_IO_layout_for_digital_cha	0		Decimal	SINT		
CM50I_EIP1:C.Diag_Param_Global_Diagnostic_Report	1		Decimal	SINT		
CM50I_EIP1:C.Diag_Param_Under_Voltage_Sensor_Supply1	1		Decimal	SINT		
CM50I_EIP1:C.Diag_Param_Under_Voltage_Sensor_Supply2	0		Decimal	INT		
CM50I_EIP1:C.Diag_Param_Under_Voltage_Actuator_Supp1	1		Decimal	SINT		
CM50I_EIP1:C.Diag_Param_Under_Voltage_Actuator_Supp2	0		Decimal	INT		
CM50I_EIP1:C.Diag_Param_No_Actuator_Supply_Diagnosti	1		Decimal	SINT		
CM50I_EIP1:C.Diag_Param_LED_Indication_For_Suppresse	0		Decimal	SINT		
CM50I_EIP1:C.Diag_Param_Diagnostic_Message_Acknowled	0		Decimal	SINT		
CM50I_EIP1:C.Diag_Param_Port_X0_Diagnostic_Report	0		Decimal	SINT		
CM50I_EIP1:C.Diag_Param_Port_X1_Diagnostic_Report	0		Decimal	SINT		
CM50I_EIP1:C.Diag_Param_Port_X2_Diagnostic_Report	0		Decimal	SINT		
CM50I_EIP1:C.Diag_Param_Port_X3_Diagnostic_Report	0		Decimal	SINT		
CM50I_EIP1:C.Diag_Param_Port_X4_Diagnostic_Report	0		Decimal	SINT		
CM50I_EIP1:C.Diag_Param_Port_X5_Diagnostic_Report	0		Decimal	SINT		
CM50I_EIP1:C.Diag_Param_Port_X6_Diagnostic_Report	0		Decimal	SINT		

III. 23: Configuration via EDS

Each configuration tag has a meaningful name describing the function of the areas.

- ◆ Enter the appropriate values for your application.

Result:

- ✓ Each time when being connected to the control system, the device is appropriately configured.

WebUI

Configuration can also run via WebUI if required. To use this function, when configuring the connection select in the PLC software one of the Exclusive Owner connections beginning with the "WE" prefix.

Also see about this

-  [Configuration values](#) [▶ 43]

9.2 Setting the parameters

Instruction:

- ◆ Navigate to the controller tags in window **Controller Organizer** that is found at the left in the program window.

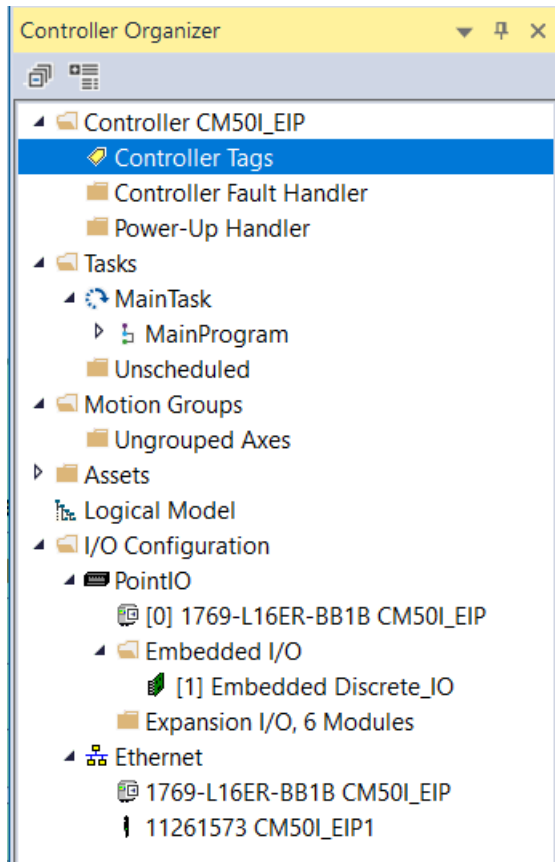

- ◆ Double-click on **Controller Tags**.

Result:

- ✓ Overview of process and configuration data opens.

Name	Value	Force Mask	Style	Data Type	Description	Constant
CM50I_EIP1:C		{...}	{...}	_01D4:11261573_...		<input type="checkbox"/>
CM50I_EIP1:I		{...}	{...}	_01D4:11261573_...		<input type="checkbox"/>
CM50I_EIP1:O		{...}	{...}	_01D4:11261573_...		<input type="checkbox"/>

- Click on the "plus" symbol in the configuration data line **Name_Of_Module: C**.
 - ✓ All device parameters open.
- Enter the application-specific parameter values.



INFO

Parameters are transferred to *Forward Open Telegram* (power reset or disconnecting power required).

Also see about this

- 📖 [Configuration values \[▶ 43\]](#)

9.3 Requested Packet Interval (RPI) configuration

Search device

In EtherNet/IP system setup, thoroughly define the RPI value in the control unit. Setting the RPI values requires the properties to be open.

In the **Controller Organizer**:

- Double-click on the device *or*
- Right-click on the device and select **Properties** from the context menu.

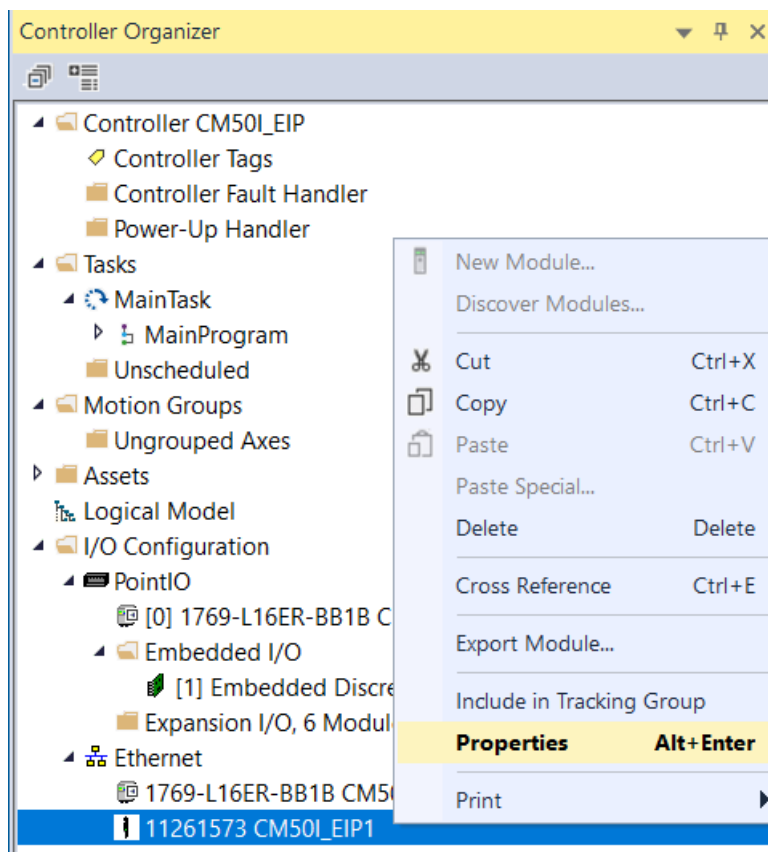

Setting the RPI values

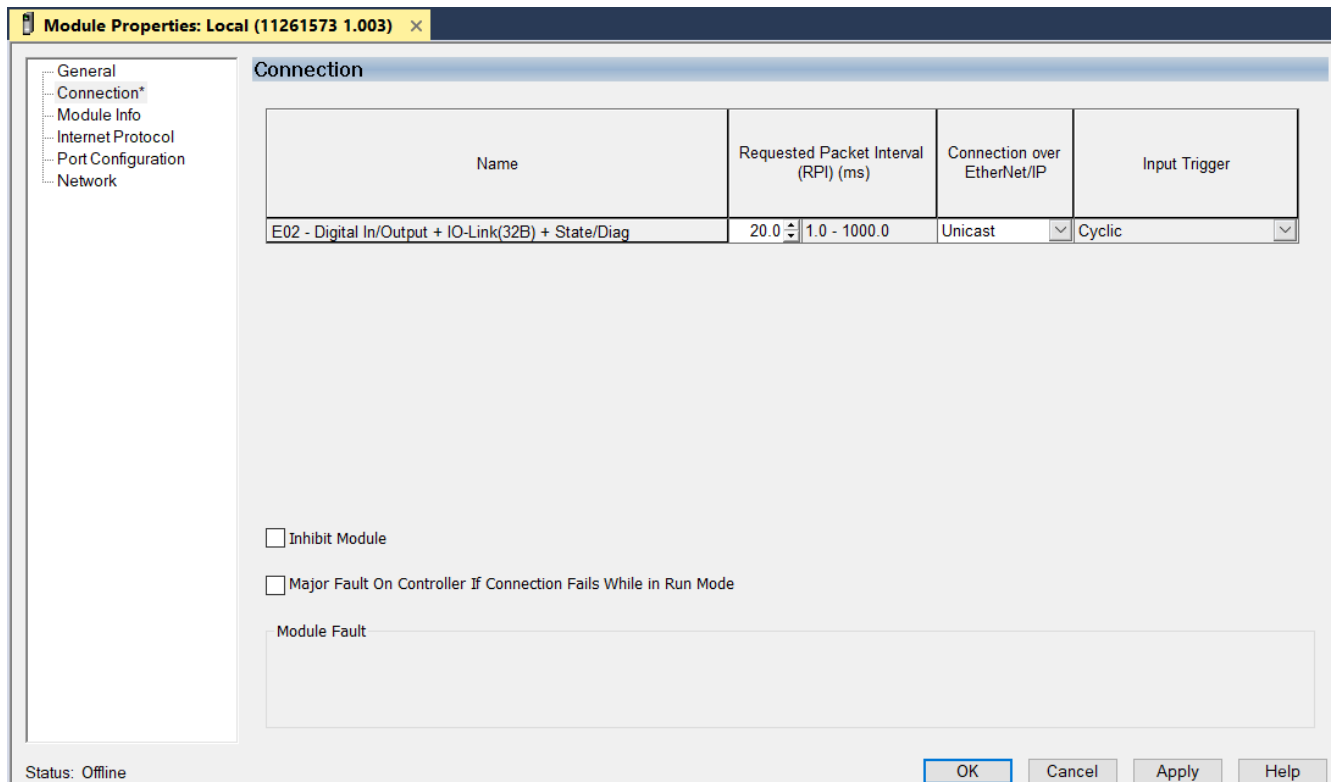

III. 24: Setting the RPI values

Instruction:

- Double-click on tag **Connection**.
- Set the desired RPI values in column **Requested Packet Interval (RPI) (ms)**.



INFO

Minimum RPI value is 1 ms.

9.4 Device Level Ring (DLR) configuration

Device Level Ring (DLR) is a protocol enabling a ring topology with EtherNet/IP devices. The ring network consists of at least one ring supervisor and any number of users.

There are two options to set up topology and to identify line breaks in ring networks:

- Beacon-Based
- Announce-Based

Requirements for configuration and diagnostics:

- Users to support DLR
- User has implemented object DLR (0 x 47)

Using non DLR-capable devices in an EtherNet/IP ring network is not ruled out, but implicates increased ring recovery time when separating the ring topology.



INFO

The devices described in the present instruction support Beacon-Based DLR technology.

9.5 IO-Link configuration

IO-Link configuration

Module *CM50I* provides two ways for IO-Link device configuration and parameterization:

- IO-Link device configuration Explicit Messages in EtherNet/IP
- *Baumer Sensor Suite (BSS)*

IO-Link device configuration Explicit Messages in EtherNet/IP

Connected IO-Link devices allow for parameterization via EtherNet/IP Explicit Messages.



INFO

For further information please see chapter 9.2.1 "Control unit diagnostic structure".

Baumer Sensor Suite (BSS)

BSS allows for IO-Link device parameterization.

IO-Link data is visualized via a graphical interface and the parameterization of the device is made possible in the simplest possible way.



INFO

Software *Baumer Sensor Suite (BSS)* and the corresponding manual is available at *Baumer* website <https://www.baumer.com/bss>.

9.6 Industrial Internet of Things (IIoT)

9.6.1 JSON

JSON standard settings

No.	REST API URL	Description	Supporting
1	GET /iolink/v1/gateway/identification	Identification of the gateway	Yes
2	GET /iolink/v1/gateway/capabilities	Capabilities of the gateway	Yes
3	GET /iolink/v1/gateway/configuration	Read network configuration of the gateway	Yes
4	POST /iolink/v1/gateway/configuration	Write network configuration of the gateway	Yes
5	POST /iolink/v1/gateway/reset	Reset the gateway including all masters	-
6	POST /iolink/v1/gateway/reboot	Reboot the gateway including all masters	-
7	GET /iolink/v1/gateway/events	Event log containing all events from gateway, masters, ports, and devices	Yes
8	GET /iolink/v1/masters	Get all available master number keys and identification information	Yes
9	GET /iolink/v1/masters/\$MASTER_NUMBER/capabilities	Capabilities of the master	Yes
10	GET /iolink/v1/masters/\$MASTER_NUMBER/identification	Read identification of the master	Yes

No.	REST API URL	Description	Supporting
11	POST /iolink/v1/masters/\$MASTER_NUMBER/ identification	Write identification of the master	Yes
12	GET /iolink/v1/masters/\$MASTER_NUMBER/ports	Get all available port number keys	Yes
13	GET /iolink/v1/masters/\$MASTER_NUMBER/ports/ \$PORT_NUMBER/capabilities	Read capability information of the specified port	Yes
14	GET /iolink/v1/masters/\$MASTER_NUMBER/ports/ \$PORT_NUMBER/status	Read status of the master	Yes
15	GET /iolink/v1/masters/\$MASTER_NUMBER/ports/ \$PORT_NUMBER/configuration	Read configuration of the specified port	Yes
16	POST /iolink/v1/masters/\$MASTER_NUMBER/ ports/\$PORT_NUMBER/configuration	Write configuration of the specified port	Yes
17	GET /iolink/v1/masters/\$MASTER_NUMBER/ports/ \$PORT_NUMBER/datastorage	Read data storage content of the specified port	Yes
18	POST /iolink/v1/masters/\$MASTER_NUMBER/ ports/\$PORT_NUMBER/datastorage	Write data storage content of the specified port	Yes
19	GET /iolink/v1/devices	Address all devices of all masters	Yes
20	GET /iolink/v1/devices/{deviceAlias}/ capabilities	Read capability information of the specified device	Yes
21	GET /iolink/v1/devices/{deviceAlias}/ identification	Read identification information of the specified device	Yes
22	POST /iolink/v1/devices/{deviceAlias}/identification	Write identification information of the specified device	-
23	GET /iolink/v1/devices/{deviceAlias}/ processdata/ value?format=byteArray	Read process data value from the specified device	Yes
24	GET /iolink/v1/devices/{deviceAlias}/ processdata/ getdata/value?format=byteArray	Read process data input value from the specified device	Yes
25	GET /iolink/v1/devices/{deviceAlias}/ processdata/ setdata/value?format=byteArray	Read process data output value from the specified device	Yes
26	POST /iolink/v1/devices/{deviceAlias}/processdata/ value	Write the process data output value to the specified device	Yes
27	GET /iolink/v1/devices/{deviceAlias}/ parameters/ {index}/value/?format=byteArray	Read a specific parameter value and its sub-parameter values (if the parameter has complex type) with the given index of the device	Yes

No.	REST API URL	Description	Supporting
28	GET /iolink/v1/devices/{deviceAlias}/parameters/{index}/subindices/{subindex}/value/?format=byteArray	Read the value of a specific sub-parameter with the given index and subindex	Yes
29	GET /iolink/v1/devices/{deviceAlias}/parameters/{parameterName}/value/?format=byteArray	Read a specific parameter value with the given name	-
30	POST /iolink/v1/devices/{deviceAlias}/parameters/{index}/value	Write the parameter with the given index to the device	Yes
31	POST /iolink/v1/devices/{deviceAlias}/parameters/{parameterName}/value	Write the parameter with the given name to the device	-
32	POST /iolink/v1/devices/{deviceAlias}/parameters/{index}/subindices/{subindex}/value	Write the sub-parameter with the given index and subindex to the device	Yes
33	POST /iolink/v1/devices/{deviceAlias}/parameters/{parameterName}/subindices/{subParameterName}/value	Write the sub-parameter with the given parameter name and sub-parameter name to the device	-
34	POST /iolink/v1/devices/{deviceAlias}/blockparametrization/?format=byteArray	Read or write one or more parameters as a block	Yes
35	GET /iolink/v1/devices/{deviceAlias}/events	Read event log from the specified device	Yes
36	GET /iolink/v1/mqtt/configuration	Read configuration of MQTT clients	Yes
37	POST /iolink/v1/mqtt/configuration	Write configuration of MQTT clients	-
38	GET /iolink/v1/mqtt/topics	Read list of MQTT topics	-
39	POST /iolink/v1/mqtt/topics	Write list of MQTT topics	-
40	DELETE /iolink/v1/mqtt/topics/{topicID}	Delete a specific MQTT topic	-
41	GET /iolink/v1/mqtt/topics/{topicID}	Read a specific MQTT topic	-
42	GET /iolink/v1/mqtt/connectionstatus	Read connection status	Yes

Vendor-specific JSON settings

No.	REST API URL	Description	Supporting
43	GET /iolink/v1/vendor/masters/\$MASTER_NUMBER/diagnostics/configuration	Diagnostic configuration of the master	Yes
44	GET /iolink/v1/vendor/masters/\$MASTER_NUMBER/diagnostics/value	Diagnostic values of the master	Yes
45	GET /iolink/v1/vendor/masters/	Current statistic values of the specified port of the master	Yes

No.	REST API URL	Description	Supporting
	\$MASTER_NUMBER/ports/ \$PORT_NUMBER/ statistics/current		
46	GET /iolink/v1/vendor/masters/ \$MASTER_NUMBER/ports/ \$PORT_NUMBER/ statistics/voltage	Voltage statistic values of the specified port of the master	Yes
47	GET /iolink/v1/vendor/masters/ \$MASTER_NUMBER/ports/ \$PORT_NUMBER/ statistics/temperature	Temperature statistic values of the specified port of the master	Yes
48	GET /iolink/v1/vendor/masters/1/ ports/1/statistics/ stack	IO-Link stack statistic values of the specified port of the master	-
49	GET /iolink/v1/vendor/masters/ \$MASTER_NUMBER/ports/ \$PORT_NUMBER/ diagnostics/configuration	Diagnostic configuration of the specified port of the master	Yes
50	GET /iolink/v1/vendor/masters/ \$MASTER_NUMBER/ports/ \$PORT_NUMBER/ diagnostics/current	Diagnostic current value of the specified port of the master	Yes
51	GET /iolink/v1/vendor/masters/ \$MASTER_NUMBER/ports/ \$PORT_NUMBER/ diagnostics/voltage	Diagnostic voltage value of the specified port of the master	Yes
52	GET /iolink/v1/vendor/masters/ \$MASTER_NUMBER/ports/ \$PORT_NUMBER/ diagnostics/temperature	Diagnostic temperature value of the specified port of the master	Yes

9.6.2

MQTT



INFO

If MQTT is enabled, mandatory that JSON is activated as well.

MQTT settings

No.	MQTT topics	Description
1	\$MQTT_CLIENT_HEAD_TOPIC /iolink/v1/ gateway/ identification	Identification of the gateway
2	\$MQTT_CLIENT_HEAD_TOPIC /iolink/v1/ gateway/ capabilities	Capabilities of the gateway
3	\$MQTT_CLIENT_HEAD_TOPIC /iolink/v1/ gateway/ configuration	Network configuration of the gateway
4	\$MQTT_CLIENT_HEAD_TOPIC /iolink/v1/ masters	Get all available master number keys and identification information

No.	MQTT topics	Description
5	\$MQTT_CLIENT_HEAD_TOPIC /iolink/v1/masters/\$MASTER_NUMBER/diagnostics/value	Diagnostic values of the master
6	\$MQTT_CLIENT_HEAD_TOPIC /iolink/v1/masters/\$MASTER_NUMBER/diagnostics/configuration	Diagnostic configuration of the master
7	\$MQTT_CLIENT_HEAD_TOPIC /iolink/v1/masters/\$MASTER_NUMBER/capabilities	Capabilities of the master
8	\$MQTT_CLIENT_HEAD_TOPIC /iolink/v1/masters/\$MASTER_NUMBER/identification	Identification of the master
9	\$MQTT_CLIENT_HEAD_TOPIC /iolink/v1/masters/\$MASTER_NUMBER/ports	Get all available port number keys
10	\$MQTT_CLIENT_HEAD_TOPIC /iolink/v1/masters/\$MASTER_NUMBER/ports/\$PORT_NUMBER/capabilities	Read capability information of the specified port
11	\$MQTT_CLIENT_HEAD_TOPIC /iolink/v1/masters/\$MASTER_NUMBER/ports/\$PORT_NUMBER/status	Read actual status of the specified port
12	\$MQTT_CLIENT_HEAD_TOPIC /iolink/v1/masters/\$MASTER_NUMBER/ports/\$PORT_NUMBER/configuration	Read/Write configuration of the specified port
13	\$MQTT_CLIENT_HEAD_TOPIC /iolink/v1/masters/\$MASTER_NUMBER/ports/\$PORT_NUMBER/diagnostics/configuration	Diagnostic configuration of the specified port of the master
14	\$MQTT_CLIENT_HEAD_TOPIC /iolink/v1/masters/\$MASTER_NUMBER/ports/\$PORT_NUMBER/diagnostics/current	Diagnostic current value of the specified port of the master
15	\$MQTT_CLIENT_HEAD_TOPIC /iolink/v1/masters/\$MASTER_NUMBER/ports/\$PORT_NUMBER/diagnostics/voltage	Diagnostic voltage value of the specified port of the master
16	\$MQTT_CLIENT_HEAD_TOPIC /iolink/v1/masters/\$MASTER_NUMBER/ports/\$PORT_NUMBER/diagnostics/temperature	Diagnostic temperature value of the specified port of the master
17	\$MQTT_CLIENT_HEAD_TOPIC /iolink/v1/masters/\$MASTER_NUMBER/ports/\$PORT_NUMBER/statistics/current	Current statistic values of the specified port of the master
18	\$MQTT_CLIENT_HEAD_TOPIC /iolink/v1/masters/\$MASTER_NUMBER/ports/\$PORT_NUMBER/statistics/voltage	Voltage statistic values of the specified port of the master
19	\$MQTT_CLIENT_HEAD_TOPIC /iolink/v1/masters/\$MASTER_NUMBER/ports/\$PORT_NUMBER/statistics/temperature	Temperature statistic values of the specified port of the master
20	\$MQTT_CLIENT_HEAD_TOPIC /iolink/v1/devices/\$DEVICE_ALIAS/processdata/value	Read/Write process data value from/to the specified device

No.	MQTT topics	Description
21	\$MQTT_CLIENT_HEAD_TOPIC /iolink/v1/devices/\$DEVICE_ALIAS/processdata/getdata/value	Read process data input value from the specified device
22	\$MQTT_CLIENT_HEAD_TOPIC /iolink/v1/devices/\$DEVICE_ALIAS/processdata/setdata/value	Read process data output value from the specified device
23	\$MQTT_CLIENT_HEAD_TOPIC /iolink/v1/devices/\$DEVICE_ALIAS/events	Read event log from the specified device
24	\$MQTT_CLIENT_HEAD_TOPIC /Asset	Information about the publisher (network, vendor, firmware)
25	\$MQTT_CLIENT_HEAD_TOPIC /Online	Status of the publisher (online when connected)

9.6.3 OPC UA

9.6.3.1 Device identification

The device provides nodes for device identification. From this node, the *OPC UA* client for example will read the applied device firmware revision.

Node ID	Node class	Access	Description
Manufacturer	Variable	read	Device manufacturer
ManufacturerUri	Variable	read	Device manufacturer URL
Model	Variable	read	Device model designation
ProductCode	Variable	read	Device product code
RevisionCounter	Variable	read	Device Hardware Revision
SerialNumber	Variable	read	Device serial number
SoftwareRevision	Variable	read	Device firmware revision

Tab. 15: Device identification

The screenshot shows the OPC UA client interface. On the left is a tree view of the node hierarchy. The 'Manufacturer' node is selected. On the right is a table showing the values for the selected node and its children.

#	Server	Node Id	Display Name	Value	Datatype
1	CM50I	NS6 Numeric 161	Manufacturer	"en", "Baumer"	LocalizedText
2	CM50I	NS6 Numeric 166	ManufacturerUri	www.baumer.com	String
3	CM50I	NS6 Numeric 162	Model	"en", "CM50I.PN"	LocalizedText
4	CM50I	NS6 Numeric 167	ProductCode	11261571	String
5	CM50I	NS6 Numeric 163	RevisionCounter	1	Int32
6	CM50I	NS6 Numeric 164	SerialNumber	6040000002979658	String
7	CM50I	NS6 Numeric 165	SoftwareRevision	V1.3.0	String

III. 25: Device identification

9.6.3.2 Process data

The *OPC UA* server provides nodes including process data. For example, in node **Pin2ProcessData** the *OPC UA* client can read out a port value provided at pin 2.

Node ID	Node class	Access	Description
Pin2ProcessData	Variable	read	Process data at pin 2
Pin4ProcessData	Variable	read	Process data at pin 4

Tab. 16: Process data

The screenshot shows the OPC UA client interface. On the left, a tree view displays the hierarchy of nodes. The 'SIOPProcessData' node is selected and expanded, showing 'Pin2ProcessData' and 'Pin4ProcessData' as sub-nodes. On the right, a table lists the properties of these nodes.

#	Server	Node Id	Display Name	Value
1	CM50I	NS6 Numeric 33340	Pin2ProcessData	false
2	CM50I	NS6 Numeric 33341	Pin4ProcessData	false

III. 26: Process data

9.6.3.3 Configuration parameters

The *OPC UA* server provides nodes with device configuration parameters. For example, in node **OverTemperature** the *OPC UA* client can read out the maximum temperature limit.

Node ID	Node class	Access	Default	Description
CurrentHysteresis	Variable	read	10 mA	Current hysteresis, unit: mA If the limit is exceeded by current, current must first drop below again by the hysteresis value to cancel diagnostics.
OverTemperature	Variable	read	70 °C	Maximum limit for port temperature, unit: 0.1 °C
OverVoltageL	Variable	read	30 V	Maximum power limit assigned to supply line 1 enabling monitoring of pins L+, DI, DO, DIO, IO-Link. Unit: mV
OverVoltageL2	Variable	read	30 V	Maximum power limit assigned to supply line 2, unit: mV
TemperatureHysteresis	Variable	read	2 °C	Temperature hysteresis, unit: 0.1 °C If the limit is exceeded by temperature, temperature must first drop below again by the hysteresis value to cancel diagnostics.
UnderTemperature	Variable	read	-25 °C	Minimum limit for port temperature, unit: 0.1°C°
UnderVoltage L	Variable	read	18 V	Minimum power limit assigned to supply line 1 enabling monitoring of pins L+, DI, DO, DIO, IO-Link. Unit: mV
UnderVoltage L2	Variable	read	18 V	Minimum power limit assigned to supply line 2, unit: mV
Voltage Hysteresis	Variable	read	300 mV	Voltage hysteresis, unit: mV If the limit is exceeded by voltage, voltage must first drop below again by the hysteresis value to cancel diagnostics.

Tab. 17: Device specific configuration parameters

#	Server	Node Id	Display Name	Value	Datatype
1	CM50I	NS6 Numeric 2057	CurrentHysteresis	10	UInt16
2	CM50I	NS6 Numeric 2050	OverTemperature	70	Float
3	CM50I	NS6 Numeric 2058	OverVoltageL	30000	Int32
4	CM50I	NS6 Numeric 2059	OverVoltageL2	30000	Int32
5	CM50I	NS6 Numeric 2051	TemperatureHyster...	2	Float
6	CM50I	NS6 Numeric 2049	UnderTemperature	-25	Float
7	CM50I	NS6 Numeric 2060	UnderVoltageL	17000	Int32
8	CM50I	NS6 Numeric 2061	UnderVoltageL2	17000	Int32
9	CM50I	NS6 Numeric 2062	VoltageHysteresis	300	UInt16

III. 27: Device specific configuration parameters

Node ID	Node class	Access	Default	Description
OverCurrentPin1, OverCurrentPin2, OverCurrentPin4	Variable	read	0	Warning level for maximum current limit at pin 1, pin 2 or pin 4, unit: 1mA
UnderCurrent-Pin1, UnderCurrent-Pin2, UnderCurrentPin4	Variable	read	0	Warning level for minimum current limit at pin 1, pin 2 or pin 4, unit: 1mA 0: monitoring not enabled

Tab. 18: Port-specific configuration parameters

#	Server	Node Id	Display Name	Value	Datatype
1	CM50I	NS6 Numeric 34860	OverCurrentPin1	0	Int32
2	CM50I	NS6 Numeric 34862	OverCurrentPin2	0	Int32
3	CM50I	NS6 Numeric 34864	OverCurrentPin4	0	Int32
4	CM50I	NS6 Numeric 34861	UnderCurrentPin1	0	Int32
5	CM50I	NS6 Numeric 34863	UnderCurrentPin2	0	Int32
6	CM50I	NS6 Numeric 34865	UnderCurrentPin4	0	Int32

III. 28: Port-specific configuration parameters

9.6.3.4 Measured values

The *OPC UA* server provides nodes with calculated measured values. For example, in node **SumCurrentL** the *OPC UA* client can read in calculated total current of supply line 1.

Node ID	Node class	Access	Description
SumCurrentL	Variable	read	The total current calculated from individual measurements in supply line 1, unit: mA
SumCurrentL2	Variable	read	The total current calculated from individual measurements in supply line 2, unit: mA
MeanTemperature	Variable	read	Average temperature value assigned to the component, calculated from each temperature value individually measured at the three chips. Unit: °C
MeanVoltageL	Variable	read	Average voltage in supply line 1, unit: mV
MeanVoltageL2	Variable	read	Average voltage in supply line 2, unit: mV

Tab. 19: Device-specific (calculated) measured values

#	Server	Node Id	Display Name	Value	Datatype
1	CM50I	NS6 Numeric 2052	SumCurrentL	114	Int32
2	CM50I	NS6 Numeric 2053	SumCurrentL2	0	Int32
3	CM50I	NS6 Numeric 2054	MeanTemperature	34.6	Float
4	CM50I	NS6 Numeric 2055	MeanVoltageL	24037	Int32
5	CM50I	NS6 Numeric 2056	MeanVoltageL2	24180	Int32

III. 29: Device-specific (calculated) measured values

Node ID	Node class	Access	Description
CurrentPin1, CurrentPin2, CurrentPin4	Variable	read	Current measured at pin 1, pin 2 or pin 4, unit: mA
TemperaturePin1, TemperaturePin2, TemperaturePin4	Variable	read	Temperature measured at pin 1, pin 2 or pin 4, unit: °C
VoltagePin1, VoltagePin2, VoltagePin4	Variable	read	Voltage measured at pin 1, pin 2 or pin 4, unit: mA

Tab. 20: Port specific measuring values

#	Server	Node Id	Display Name	Value	Datatype
1	CM50I	NS6 Numeric 34836	CurrentPin1	31	Int32
2	CM50I	NS6 Numeric 34837	CurrentPin2	0	Int32
3	CM50I	NS6 Numeric 34838	CurrentPin4	0	Int32
4	CM50I	NS6 Numeric 34854	MaxTemperaturePin1	36.7	Float
5	CM50I	NS6 Numeric 34855	MaxTemperaturePin2	36.7	Float
6	CM50I	NS6 Numeric 34856	MaxTemperaturePin4	36.7	Float
7	CM50I	NS6 Numeric 34851	MinVoltagePin1	24022	Int32
8	CM50I	NS6 Numeric 34852	MinVoltagePin2	-162	Int32
9	CM50I	NS6 Numeric 34853	MinVoltagePin4	-153	Int32

III. 30: Port specific measuring values

9.6.3.5 Diagnostic tools

The OPC UA server provides nodes with diagnostic information. In node **DiagnosticsPin1**, the OPC UA client can read whether the device has identified presence of any over current at pin 1 of a port.

Node ID	Node class	Access	Description
DiagnosticsPin1, DiagnosticsPin2, DiagnosticsPin4	Variable	read	Diagnostics on pin 1, pin 2 or pin 4. The numerical value contains bit-coded information: <ul style="list-style-type: none"> ■ Bit 0: Short circuit, ■ Bit 1: Overload protection, ■ Bit 2: Overtemperature protection, ■ Bit 3: Overvoltage protection, ■ Bit 4: Overcurrent, ■ Bit 5: Undercurrent ■ Bit 0: Overtemperature ■ Bit 1: Undertemperature ■ Bit 2: Overvoltage ■ Bit 3: Undervoltage

Node ID	Node class	Access	Description
			<ul style="list-style-type: none"> Bit 4: Watchdog 0: Diagnosis not active 1: Diagnosis active

Tab. 21: Port-specific diagnostics

#	Server	Node Id	Display Name	Value	Datatype
1	CM50I	NS6 Numeric 34839	DiagnosticsPin1	0	Int32
2	CM50I	NS6 Numeric 34840	DiagnosticsPin2	0	Int32
3	CM50I	NS6 Numeric 34841	DiagnosticsPin4	0	Int32

III. 31: Port-specific diagnostics

9.6.3.6 Statistics

The OPC UA server provides nodes with statistical information. In node **MaxCurrentPin1**, the OPC UA client can read at pin 1 of a port the maximum measured current.

Node ID	Node class	Access	Description
Current			
MaxCurrentPin1, MaxCurrentPin2, MaxCurrentPin4	Variable	read	Maximum current at pin 1, pin 2 or pin 4 since value reset, unit: mA
MinCurrentPin1, MinCurrentPin2, MinCurrentPin4	Variable	read	Minimum current at pin 1, pin 2 or pin 4 since value reset, unit: mA
Temperature			
MaxTemperaturePin1, MaxTemperaturePin2, MaxTemperaturePin4	Variable	read	Maximum temperature at pin 1, pin 2 or pin 4 since value reset, unit: °C

Node ID	Node class	Access	Description
MinTemperaturePin1, MinTemperaturePin2, MinTemperaturePin4	Variable	read	Minimum temperature at pin 1, pin 2 or pin 4 since value reset, unit: °C
Voltage			
MaxVoltagePin1, MaxVoltagePin2, MaxVoltagePin4	Variable	read	Maximum voltage at pin 1, pin 2 or pin 4 since value reset, unit: mV
MinVoltagePin1, MinVoltagePin2, MinVoltagePin4	Variable	read	Minimum voltage at pin 1, pin 2 or pin 4 since value reset, unit: mV

Tab. 22: Port specific statistical information

#	Server	Node Id	Display Name	Value	Datatype
1	CM50I	NS6 Numeric 34842	MaxCurrentPin1	38	Int32
2	CM50I	NS6 Numeric 34843	MaxCurrentPin2	10	Int32
3	CM50I	NS6 Numeric 34844	MaxCurrentPin4	0	Int32
4	CM50I	NS6 Numeric 34845	MinCurrentPin1	9	Int32
5	CM50I	NS6 Numeric 34846	MinCurrentPin2	0	Int32
6	CM50I	NS6 Numeric 34847	MinCurrentPin4	0	Int32
7	CM50I	NS6 Numeric 34854	MaxTemperaturePin1	36.7	Float
8	CM50I	NS6 Numeric 34855	MaxTemperaturePin2	36.7	Float
9	CM50I	NS6 Numeric 34856	MaxTemperaturePin4	36.7	Float
10	CM50I	NS6 Numeric 34857	MinTemperaturePin1	28.8	Float
11	CM50I	NS6 Numeric 34858	MinTemperaturePin2	28.8	Float
12	CM50I	NS6 Numeric 34859	MinTemperaturePin4	28.8	Float
13	CM50I	NS6 Numeric 34848	MaxVoltagePin1	24068	Int32
14	CM50I	NS6 Numeric 34849	MaxVoltagePin2	23545	Int32
15	CM50I	NS6 Numeric 34850	MaxVoltagePin4	23111	Int32
16	CM50I	NS6 Numeric 34851	MinVoltagePin1	24022	Int32
17	CM50I	NS6 Numeric 34852	MinVoltagePin2	-162	Int32
18	CM50I	NS6 Numeric 34853	MinVoltagePin4	-153	Int32

III. 32: Port specific statistical information

10 Operation

10.1 LED indicator

The device provides clearly arranged indicators:

- LED indicator inputs / outputs
- LED indicator BUS
- LED indicator POWER
- Advanced LED indicator

The front LED indicators are correspondingly marked for clear assignment. Either indicated by continuous or flashing LEDs.

10.1.1 LED assignment to channel and pin

Each input and output is assigned an individual status indicator.

- LED channel 0X (X= port number) is assigned to **pin 4** .
- LED channel 1X (X= port number) is assigned to **pin 2** .

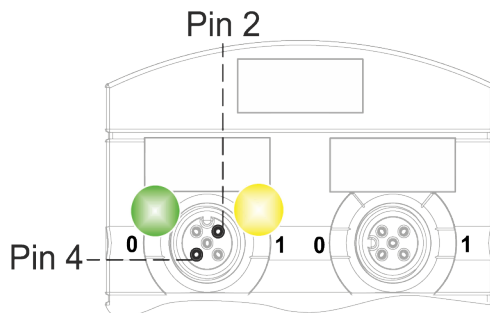

10.1.2 LED flashing behavior

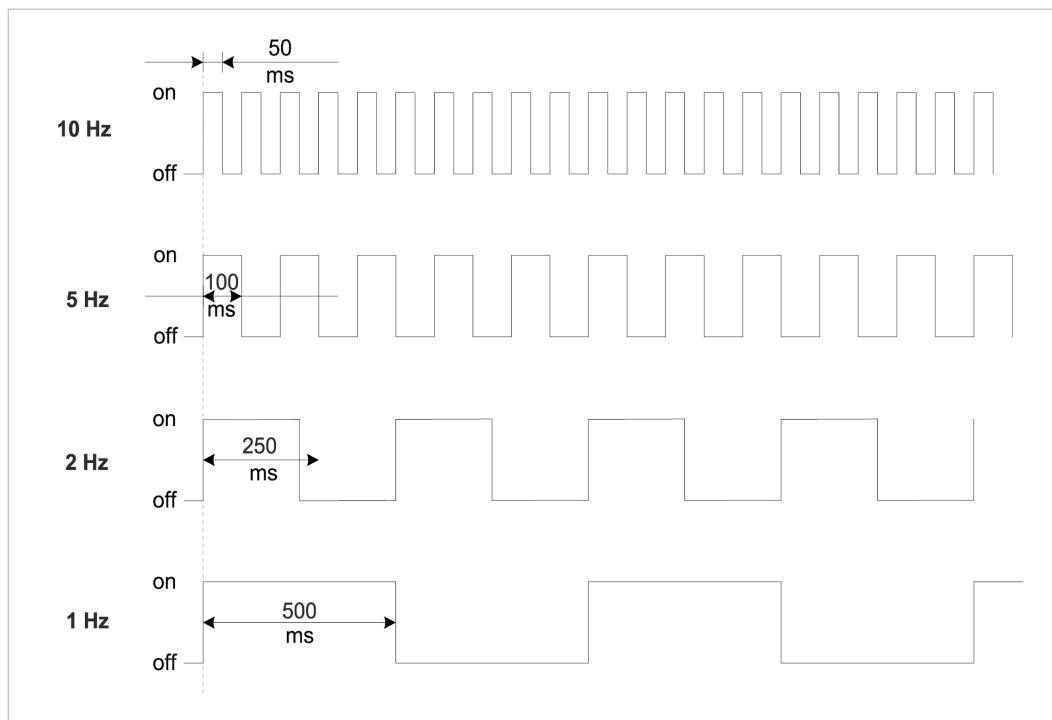



///. 33: LED flashing behavior

10.1.3 LED indicator for inputs and outputs







Each input and output is assigned an individual status indicator.

Pin 2 digital input DI

Indicator	Status	Description
 Yellow	On continuous	Permanent configuration: DI (NO) visible in process data. 24 V
 Red	Flashing at 1 Hz	Overload/short circuit in sensor supply 24 V + Pin1
 Off	Off	Pin 2 is not assigned or disabled

Tab. 23: LED indicator DI pin 2

PIN 2 digital output DO



Indicator	Status	Description
 Yellow	On continuous	Permanent configuration: DO switchable by process data 24 V
 Red	On continuous	Overload / short circuit at pin 2
 Red	Flashing at 1 Hz	Overload/short circuit in sensor supply 24 V + Pin1
 Off	Off	Pin 2 is not assigned or disabled

Tab. 24: LED indicator DO pin 2

Error at the input or output





In the event of error present at one of the inputs or outputs, the related LED at the M12 port will light up red.

Pin 4 digital input DI

Indicator	Status	Description
 Yellow	On continuous	Permanent configuration: DI (NO) visible in process data 24 V
 Red	Flashing at 1 Hz	Overload/short circuit in sensor supply 24 V + Pin1
 Off	Off	Pin 4 is not assigned or disabled







Tab. 25: LED indicator DI pin 4

PIN 4 digital output DO

Indicator	Status	Description
 Yellow	On continuous	Permanent configuration: DO switchable by process data 24 V
 Red	On continuous	Overload / short circuit at pin 4
 Red	Flashing at 1 Hz	Overload/short circuit in sensor supply 24 V + Pin1
 Off	Off	Pin 4 is not assigned or disabled

Tab. 26: LED indicator DO pin 4

Pin 4 IO-Link mode

Indicator	Status	Description
 Green	On continuous	IO-Link in status <i>Operate</i> .
 Green	Flashing at 1 Hz	<ul style="list-style-type: none"> ▪ Device is not connected ▪ No communication with connected device.
 Green	Flashing at 10 Hz	<ul style="list-style-type: none"> ▪ IO-Link in status <i>Pre-Operate</i> during data storage ▪ Validation failed. Connected IO-Link not compatible.
 Red	On continuous	Overload / short circuit at pin 4
 Red	Flashing at 2 Hz	<ul style="list-style-type: none"> ▪ Validation failed. ▪ Connected IO-Link device for data storage is not compatible. ▪ Data storage failed.
 Off	Off	IO-Link connection deactivated.





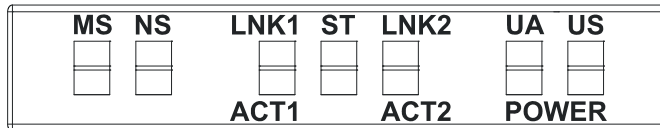

Tab. 27: LED indicator IO-Link mode Pin 4

10.1.4 LED indicators MS and NS



- **NS** (network status) - provides the fieldbus status.
- **MS** (device status) - provides the device status in the PLC configuration.







LED indicator MS

Indicator	Status	Description
 Green	On continuous	Device in operation
 Green	Flashing at 1 Hz	Standby: Device has not been configured.
 Green/red	Flashing at 1 Hz	Self-Test
 Red	Flashing at 1 Hz	Fatal recoverable error*
 Red	On continuous	Fatal unrecoverable error. <i>Verify conflicting IP address.</i>
 Off	Off	No power supply present

Tab. 28: LED indicator MS

* Incorrect or inconsistent configuration is considered a fatal recoverable error.

LED indicator NS

Indicator	Status	Description
 Green	On continuous	<ul style="list-style-type: none"> ▪ Connection to master present. ▪ IP address is being configured.
 Green	Flashing at 1 Hz	<ul style="list-style-type: none"> ▪ No connection to master. ▪ IP address is configured.
 Green/red	Flashing at 1 Hz	Self-Test
 Red	Flashing at 1 Hz	Timeout in at least one connection.
 Red	On continuous	IP address is provided twice: device has recognized that its IP address is already used. <i>Verify conflicting IP address.</i>
 Off	Off	<ul style="list-style-type: none"> ▪ No power supply present. ▪ No IP address configured.

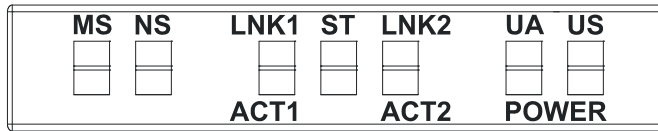

Tab. 29: LED indicator NS

10.1.5 LED indicator LNK/ACT





- LNK/ACT LNK/ACT (Link/Activity) indicates the status of EtherCAT communication at each port.

LED indication LNK/ACT

LED indicator	LED status	Description
 Green	On continuous	Connection to network present.
	Off	No connection to network.

Tab. 30: LED indication LNK/ACT

LED indicator ACT

LED indicator	LED status	Description
 Yellow	Flashing	Device is transmitting / receiving Ethernet frames
	Off	The device is transmitting /receiving Ethernet frames

Tab. 31: LED indicator ACT

LED indicator off

This is what to do:

Instruction:



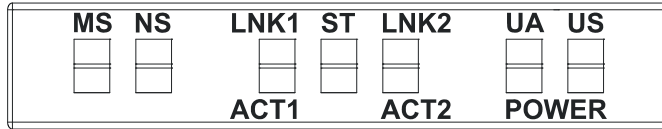

- ◆ Check the line connections.

10.1.6 LED status indicator



- ST indicates the overall device status.

LED indicator ST

Indicator	Status	Description
 Green	On continuous	Regular FW is running. Error-free operation.
 Green	Flashing at 4 Hz	The process requested by rotary switch position is being executed. Do not switch off device.
 Red	Flashing at 2 Hz	Invalid rotary switch position. System does not start.
 Red	On continuous	Initialization error. Error during device initialization. <ul style="list-style-type: none"> ▪ HW issues, ▪ no valid configuration, ▪ COM FW not found ▪ rotary switch operation failed, etc.

Tab. 32: LED indicator ST

LED indicator flashing red

This is what to do:

Instruction:

- Select a valid position.
- Restart device.



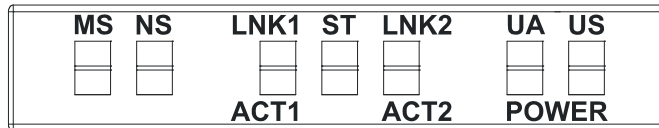

10.1.7 LED-Anzeige POWER US and UA



The power LEDs indicate the supply status





- **UA** actuator voltage
- **US** operating voltage

LED indicator POWER US

Indicator	Status	Description
 Green	On continuous	$18\text{ V} \leq \text{US} \leq 30\text{ V}$ error-free operation
 Red	On continuous	$11\text{ V} \leq \text{US} \leq 18\text{ V}$ undervoltage
 Red	Flashing at 4 Hz	$\text{US} > 30\text{ V}$ overvoltage
 Grey	Off	$\text{US} < 11\text{ V}$ no voltage

Tab. 33: LED indicator POWER US

LED indicator POWER UA

Indicator	Status	Description
 Green	On continuous	$18\text{ V} \leq \text{UA} \leq 30\text{ V}$ error-free operation
 Red	On continuous	$11\text{ V} \leq \text{UA} \leq 18\text{ V}$ undervoltage
 Red	Flashing at 4 Hz	$\text{UA} > 30\text{ V}$ overvoltage
 Grey	Off	$\text{UA} < 11\text{ V}$ no voltage

Tab. 34: LED indicator POWER UA



INFO

Fault-free operation is no longer guaranteed at $\text{US} < 18\text{ V}$.

10.1.8 Advanced LED indicator

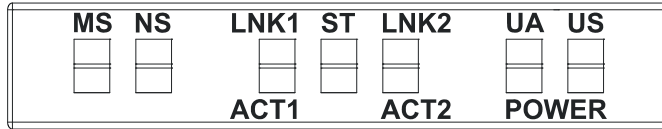



Device identification





LED	Indicator	Status	Description
MS NS ST POWE R UA POWE R US	 Green	Flashing at 1 Hz	Device identification

Tab. 35: Advanced LED indicator, device identification

Extended LED indicator update





LED	Indicator	Status	Description
MS NS ST POWE R UA POWE R US	 Yellow	Cascading running light	Update transmission in progress
	 Red		Update flashing

Tab. 36: Extended LED indicator update

LED	Indicator	Status	Description
MS POWE R UA POWE R US	 Yellow	Cascading running light	Update check in progress
	 Red	Fast flashing	Update flashing completed
	 Red	Flashing 1 Hz alternating	Update failed
ST	 Grey		



Tab. 37: Extended LED indicator update

Advanced LED indicator Factory reset

LED	Indicator	Status	Description
MS NS	 Green	Left and right flash alternately at 1 Hz	Factory reset successfully completed
POWER UA POWER US	 Yellow		Factory reset is being performed
	 Red		Factory reset was not successfully completed
ST			





Tab. 38: Advanced LED indicator Factory reset

Advanced LED indicator Recovery Firmware: System boot-up

LED	Indicator	Status	Description
ST	 Yellow	Double flash	Recovery firmware: System boot-up
NS POWER UA POWER US			





Tab. 39: Advanced LED indicator Recovery Firmware: System boot-up

Advanced LED indicator Recovery Firmware: System initialization

LED	Indicator	Status	Description
NS	 Green	On continuous	Firmware recovery: system initialization
ST	 Yellow	Double flash	
MS	 Yellow	Flashing at 1 Hz	
POWER UA POWER US			



Tab. 40: Advanced LED indicator Recovery Firmware: System initialization

Advanced LED indicator Recovery Firmware: System run

LED	Indicator	Status	Description
MS	 Green	On continuous	
ST	 Yellow	Double flash	Firmware recovery: system initialization
POWER UA	 Yellow	Flashing at 1 Hz	
POWER US			







Tab. 41: Advanced LED indicator Recovery Firmware: System run

Advanced LED indicator Firmware update: transmission is being initialized

LED	Indicator	Status	Description
MS POWER UA	 Green	On continuous	
ST	 Yellow	Double flash	Firmware update: Initializing transmission
POWER US	 Yellow	Flashing at 1 Hz	

Tab. 42: Advanced LED indicator Firmware update: transmission is being initialized

Advanced LED indicator Firmware update

LED	Indicator	Status	Description
ST	 Yellow	Double flash	
MS POWER UA	 Yellow	Cascading running light	Transmitting new firmware
POWER UA POWER US	 Yellow	Flashing 1 Hz alternating	Testing new firmware
	 Red	Cascading running light	Writing new firmware
	 Red	Single flash (Single flash)	Writing aborted
	 Red	Flashing 1 Hz alternating	Firmware writing failed

Tab. 43: Advanced LED indicator Firmware update

10.2 Diagnostic tools

10.2.1 Diagnostic structure in the control unit

Byte	Description	Value
0	Last octet of the device IP address	Last octet of the device IP address
1	IO-Link identification	0 = Default Code 0x40 = IO-Link Master Event Code 0x41 = IO-Link Device Event Code
2	Number of the master channel the error has occurred in	
3	Number of the device channel the error has occurred in	Only available if the IO-Link identifier (byte1) has been set to 0x42.
4	ErrorCode Byte1	In the sense of IO-Link it is the LSB of the IO-Link Error Code, otherwise the Global Error Code, see Tab. 9-22: "Short-circuit diagnosis (Global Error Code 0x01)".
5	ErrorCode Byte2	In the sense of IO-Link it is the MSB of the IO-Link Error Code, otherwise the Specific Error Code, see Tab. 9-22: "Short-circuit diagnosis (Global Error Code 0x01)".
6	Severity and active/inactive indicator	Bit 0: <ul style="list-style-type: none"> ▪ 0 = diagnostics Inactive ▪ 1 = diagnostics active Bit 6 and 7: <ul style="list-style-type: none"> ▪ 1 = Minor Fault ▪ 2 = Major Fault ▪ 3 = Information
7	Reserved	0



10.2.2 Webservice diagnostics

Diagnostics monitoring

Another option for device diagnostics monitoring is the diagnostics page of the integrated web server.

Representation

Here, diagnostics if known are provided as plain text:

1. **Key:** indicates which diagnostics
2. **Description:** provides a more detailed error description
3. **Severity:** differentiate between 3 categories
 - Information 
 - Warning 
 - Defect 
4. **Type:** here you can see whether diagnostics is still present or has been remedied.

There are two types of diagnostics.

Enabled



Disabled



10.2.3 Value of diagnostics

10.2.3.1 Short circuit diagnostics

Description	Value
Sensor Short Circuit	0x01
Actuator Warning	0x17
Actuator Short Circuit	0x18

Tab. 44: Short-circuit diagnostics (Global Error Code 0x01)

10.2.3.2 Undervoltage diagnostics

Description	Value
Undervoltage ActuatorPower Supply	0x28
No Voltage Actuator Power Supply	0x29
Undervoltage External Actuator Power Supply	0x2A
No Voltage External Actuator Power Supply	0x2B
Undervoltage Sensor Power Supply	0x32
No Voltage Sensor Power Supply	0x33
Undervoltage U1	0xD0
Undervoltage U2	0xD1

Tab. 45: Undervoltage diagnostics (Global Error Code 0x02)

10.2.3.3 Overvoltage diagnostics

Description	Value
Overvoltage Actuator Power Supply	0x2C
Overvoltage External Actuator Power Supply	0x2D
Overvoltage Sensor Power Supply	0x34
Overvoltage U1	0xD4
Overvoltage U2	0xD5

Tab. 46: Overvoltage diagnostics (Global Error Code 0x03)

10.2.3.4 General diagnostics

Description	Value
Error	0x00
PLC Connection Of Exclusive Owner Timed Out	0x59

Tab. 47: General diagnostics (Global Error Code 0x09)

10.2.3.5 Buffer overflow diagnostics

Description	Value
Overflow	0xFF

Tab. 48: Buffer overflow diagnostics (global error code 0xFF)

10.2.3.6 IO-Link master diagnostics

Description	Value
Error	0x0000
Error Fetching Extended Events	0x97FF
Startup Parameterization Error	0x9801
Wrong Device. Inspection Level Mismatch	0x9802
Process Data Mismatch	0x9803
Short Circuit At C/Q - Pin 4	0x9804
IO-Link PHY Overtemperature	0x9805
Short Circuit L+ - Pin1	0x9806
Undervoltage L+ - Pin1	0x9807
Device Event Overflow	0x9808
Backup Failed - Memory Out Of Range 2k	0x9809
Backup Inconsistency - Data Storage Index Not Available	0x980A
Backup Inconsistency - Data Storage Unspecific Error	0x980B
Backup Inconsistency - Upload Fault	0x980C
Parameter Inconsistency - Download Fault	0x980D
Port Class B Failure - Power Missing	0x980E

Description	Value
Short Circuit At Pin 2	0x980F
Revision Fault	0x9811
Compatibility Fault Vendor ID (IO-Link 1.0)	0x9812
Compatibility Fault Device ID (IO-Link 1.0)	0x9813
Compatibility Fault Vendor ID (IO-Link 1.1)	0x9814
Compatibility Fault Device ID (IO-Link 1.1)	0x9815
Serial Number Fault	0x9816
Generic DataStorage Fault	0x9817
Invalid Cycle Time	0xE000
Revision Fault- Incompatible Protocol Version	0xE001
Parameter Inconsistency - ISDU Batch Failed	0xE002
Device Not Available - Communication Lost	0xFF22
Invalid Backup - Data Storage Identification Mismatch	0xFF23
Invalid Backup - Data Storage Buffer Overflow	0xFF24
Invalid Backup - Data Storage Parameter Access Denied	0xFF25
Event Lost - Incorrect Event Signaling	0xFF31

Tab. 49: IO-Link master diagnostics (IO-Link identification 0x40)

10.2.3.7

IO-Link device diagnostics

Description	Value
Error	0x0000
General Malfunction	0x1000
Temperature Fault	0x4000
Ambient Temperature: General Error	0x4100
Ambient Temperature: Over-Run	0x4110
Ambient Temperature: Under-Run	0x4120
Device Temperature: General Error	0x4200
Device Temperature: Over-Run	0x4210
Device Temperature: Under-Run	0x4220
Outside Temperature: General Error	0x4300
Outside Temperature: Over-Run	0x4310
Outside Temperature: Under-Run	0x4320
Device Hardware Fault	0x5000
Component Malfunction	0x5010
Non Volatile Memory Loss	0x5011
Batteries Low	0x5012
General Power Supply Fault	0x5100
Fuse Blown/Open	0x5101

Description	Value
Primary Supply Voltage Over-Run	0x5110
Primary Supply Voltage Under-Run	0x5111
Secondary Supply Voltage Fault	0x5112
Device Supply: Voltage Under-Run U3	0x5113
Device Supply: Voltage Under-Run U4	0x5114
Device Supply: Voltage Under-Run U5	0x5115
Device Supply: Voltage Under-Run U6	0x5116
Device Supply: Voltage Under-Run U7	0x5117
Device Supply: Voltage Under-Run U8	0x5118
Device Supply: Voltage Under-Run U9	0x5119
Device Supply: Short Circuit	0x5151
Device Supply: Error In Periphery	0x5160
Device Controller: General Error	0x5200
Device Control Section: General Error	0x5300
Device Power Section: General Error	0x5400
Device Power Section: Error In Output Driver	0x5410
Device Power Section: Fuse Blown/Open	0x5450
Device Power Section: Fuse Blown/Open S1	0x5451
Device Power Section: Fuse Blown/Open S2	0x5452
Device Power Section: Fuse Blown/Open S3	0x5453
Device Power Section: Fuse Blown/Open S4	0x5454
Device Power Section: Fuse Blown/Open S5	0x5455
Device Power Section: Fuse Blown/Open S6	0x5456
Device Power Section: Fuse Blown/Open S7	0x5457
Device Power Section: Fuse Blown/Open S8	0x5458
Device Power Section: Fuse Blown/Open S9	0x5459
Error In Additional Device Communication	0x5500
Error In Device Communication Interface 2	0x5510
Device Software Fault	0x6000
Device Software: Reset (Watchdog)	0x6010
Device Software: Internal Fault	0x6100
Device Software: Dataset Error	0x6300
Loss Of Parameter	0x6310
Parameter Error	0x6320
Parameter Missing	0x6321
Parameter Not Initialized	0x6330
Parameter Not Specific	0x6340
Parameter Changed	0x6350
Wire Break Of A Subordinate Device	0x7700
Wire Break Of Subordinate Device 1	0x7701

Description	Value
Wire Break Of Subordinate Device 2	0x7702
Wire Break Of Subordinate Device 3	0x7703
Wire Break Of Subordinate Device 4	0x7704
Wire Break Of Subordinate Device 5	0x7705
Wire Break Of Subordinate Device 6	0x7706
Wire Break Of Subordinate Device 7	0x7707
Wire Break Of Subordinate Device 8	0x7708
Wire Break Of Subordinate Device 9	0x7709
Wire Break Of Subordinate Device 10	0x770A
Wire Break Of Subordinate Device 11	0x770B
Wire Break Of Subordinate Device 12	0x770C
Wire Break Of Subordinate Device 13	0x770D
Wire Break Of Subordinate Device 14	0x770E
Wire Break Of Subordinate Device 15	0x770F
Short Circuit	0x7710
Ground Fault	0x7711
Communication Monitoring: General Error	0x8100
Process Data Monitoring: General Error	0x8110
Technology Specific Application Fault	0x8C00
Simulation Active	0x8C01
Process Variable Range Over-Run	0x8C10
Measurement Range Over-Run	0x8C20
Process Variable Range Under-Run	0x8C30
Maintenance Required - Cleaning	0x8C40
Maintenance Required - Refill	0x8C41
Maintenance Required - Wear And Tear	0x8C42

Tab. 50: IO-Link device diagnostics (IO-Link identification 0x41)

10.3 Acyclic IO-Link device access

IO-Link Device Parameter Object (Class Code 0x83)

The fieldbus device allows for configuration of the connected IO-Link devices with acyclic read and write access via the IO-Link device parameter object (class code 0x83).

The IO-Link Device Parameter Object is to access the IO-Link device parameters via ISDU (Index Service Data Unit). The object provides services for mapping CIP services to IO-Link services. An IO-Link port is addressed via the CIP instance of the "IO-Link Device Parameter Object".

10.3.1 Reading an IO-Link device index

Read ISDU Request

Instruction:

- a) Use EtherNet/IP service *Read_ISDU 75 (0x4B)* for reading the index of a connected IO-Link device.
- b) For doing so, transmit the service to the correct attribute of the IO-Link device parameter object (Class Code 0x83).
- c) Attributes represent the IO-Link port to which the IO-Link device is connected.

Name	Value	Type	Description
CIP Service	75 (0x4B)	-	ISDU read service
CIP Class	131 (0x83)	-	IO-Link Device Parameter Object
CIP Instance	1 ... Number of available IO-Link Ports	-	Addresses the IO-Link Port the IO-Link device is connected to
CIP Data	Index	UINT	IO-Link ISDU Objekt Index
	Subindex	USINT	IO-Link ISDU Objekt Subindex

Tab. 51: Read ISDU Service Request structure

Read ISDU Response

Name	Value	Type	Description
CIP Service	75 (0x4B)	-	ISDU read service
CIP Class	131 (0x83)	-	IO-Link Device Parameter Object
CIP Instance	1 ... Number of available IO-Link Ports	-	Addresses the IO-Link Port the IO-Link device is connected to
CIP Data	ISDU Data	ARRAY of BYTE	IO-Link object data retrieved from the IO-Link device. Maximum number of bytes: 0 - 232

Tab. 52: Positive Response (CIP Status in service response == 0)

Name	Value	Type	Description
CIP Service	75 (0x4B)	-	ISDU read service
CIP Class	131 (0x83)	-	IO-Link Device Parameter Object
CIP Instance	1 ... Number of available IO-Link Ports	-	Addresses the IO-Link Port the IO-Link device is connected to

Name	Value	Type	Description
CIP Data	For more details on error code structure see CIP status codes [▶ 87]	UINT	IO-Link Master Error
		USINT	IO-Link Device Error
		USINT	IO-Link Device Additional Error

Tab. 53: Negative Response (CIP Status in service response != 0)

10.3.2 Writing an IO-Link device index

Write ISDU Request

Instruction:

- Writing the index of a connected IO-Link device uses the EtherNet/IP service *Write_ISDU 76 (0x4C)*.
- For doing so, transmit the service to the correct attribute of the IO-Link device parameter object (Class Code 0x83).
- Attributes represent the IO-Link port to which the IO-Link device is connected.

Name	Value	Type	Description
CIP Service	76 (0x4C)	-	ISDU write service
CIP Class	131 (0x83)	-	IO-Link Device Parameter Object
CIP Instance	1 ... Number of available IO-Link Ports	-	Addresses the IO-Link Port the IO-Link device is connected to
CIP Data	Index	UINT	IO-Link ISDU Objekt Index
	Subindex	USINT	IO-Link ISDU Objekt Subindex
	Data	ARRAY of BYTE	Data that shall be written to IO- Link device. Maximum number of bytes: 0 - 232

Tab. 54: Write ISDU Service Request structure

Write ISDU Response

Name	Value	Type	Description
CIP Service	76 (0x4C)	-	ISDU write service
CIP Class	131 (0x83)	-	IO-Link Device Parameter Object
CIP Instance	1 ... Number of available IO-Link Ports	-	Addresses the IO-Link Port the IO-Link device is connected to
CIP Data	The positive response to this service does not hold any CIP Data (Number of bytes: 0).		

Tab. 55: Positive Response (CIP Status in service response == 0)

Name	Value	Type	Description
CIP Service	76 (0x4C)	-	ISDU write service
CIP Class	131 (0x83)	-	IO-Link Device Parameter Object
CIP Instance	1 ... Number of available IO-Link Ports	-	Addresses the IO-Link Port the IO-Link device is connected to
CIP Data	For more details on error code structure see CIP status codes [▶ 87]	UINT	IO-Link Master: Error code
		USINT	IO-Link Device: Error code
		USINT	IO-Link Device: Additional error code

Tab. 56: Negative Response (CIP Status in service response != 0)

10.3.3

CIP status codes

CIP error codes

The following table provides a brief overview of the CIP status code that can be returned when accessing the *IO-Link Device Parameter* object via a CIP service. The table is without any claim of completeness.

CIP status	Description
0 (0x00)	Service was successfully performed.
5 (0x05)	Path destination unknown. Addressed CIP Class or CIP Instance is not known.
8 (0x08)	Service not supported. The requested service is not implemented or was not defined for this Object Class/Instance.
19 (0x13)	Not enough data. The service did not supply enough data to perform the specified operation.
20 (0x14)	Attribute not supported. The attribute specified in the request is not supported.
21 (0x15)	Too much data. The service supplied more data than was expected.
30 (0x1E)	An embedded service resulted in an error. The IO-Link specific error codes within the CIP response data might provide more information about what went wrong.

11 Web server

The web server is a graphical tool with which you can obtain information about the device quickly and intuitively.

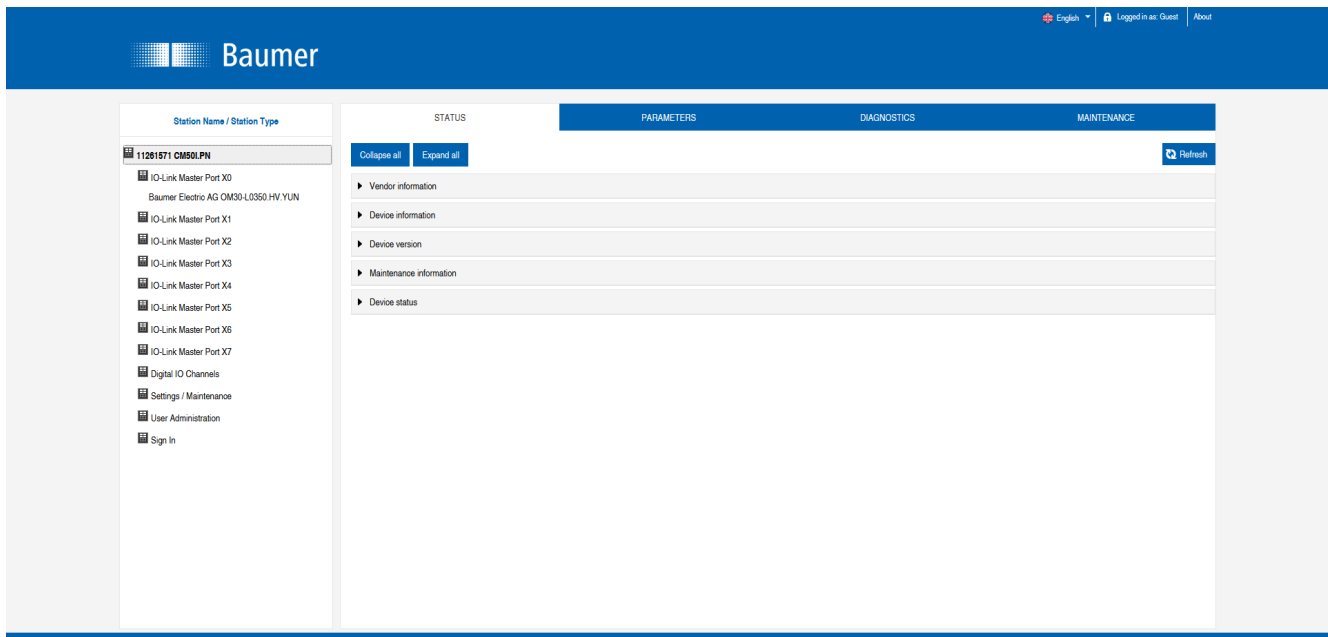

III. 34: Web server



INFO

The devices shown in the screenshots serve as examples.

11.1 Starting the web server

Condition:

⇒ The current versions of the following browsers with HTML5 and ES5 are supported: *Mozilla Firefox, Microsoft Edge, Google Chrome.*

Instruction:

- a) Start the web browser.
- b) Enter the device IP address in the web browser.

Result:

- ✓ The start screen of the web server is the **Status** page.

11.2 Access and login

Username and password

Instruction:

- ◆ Enter the login data for user name and password at the first start:
User name <admin>
Password <private>

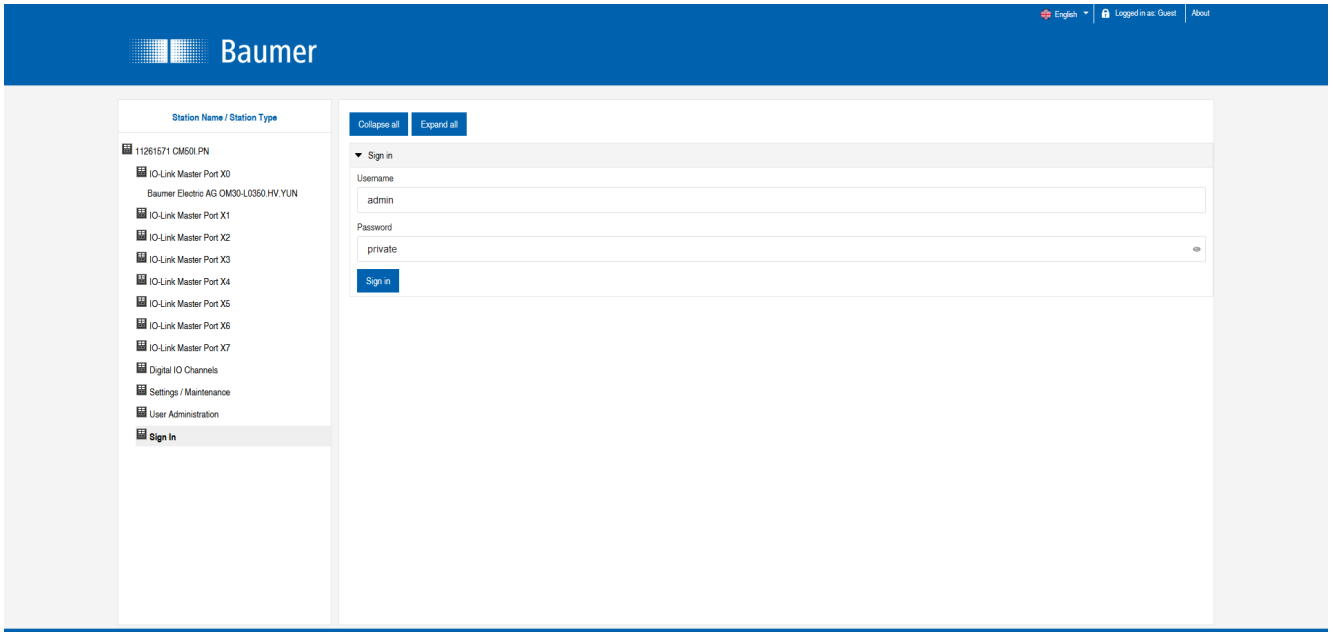

Change password

NOTICE

Ensure data security!

- Change username and password after first login and after every restore default.

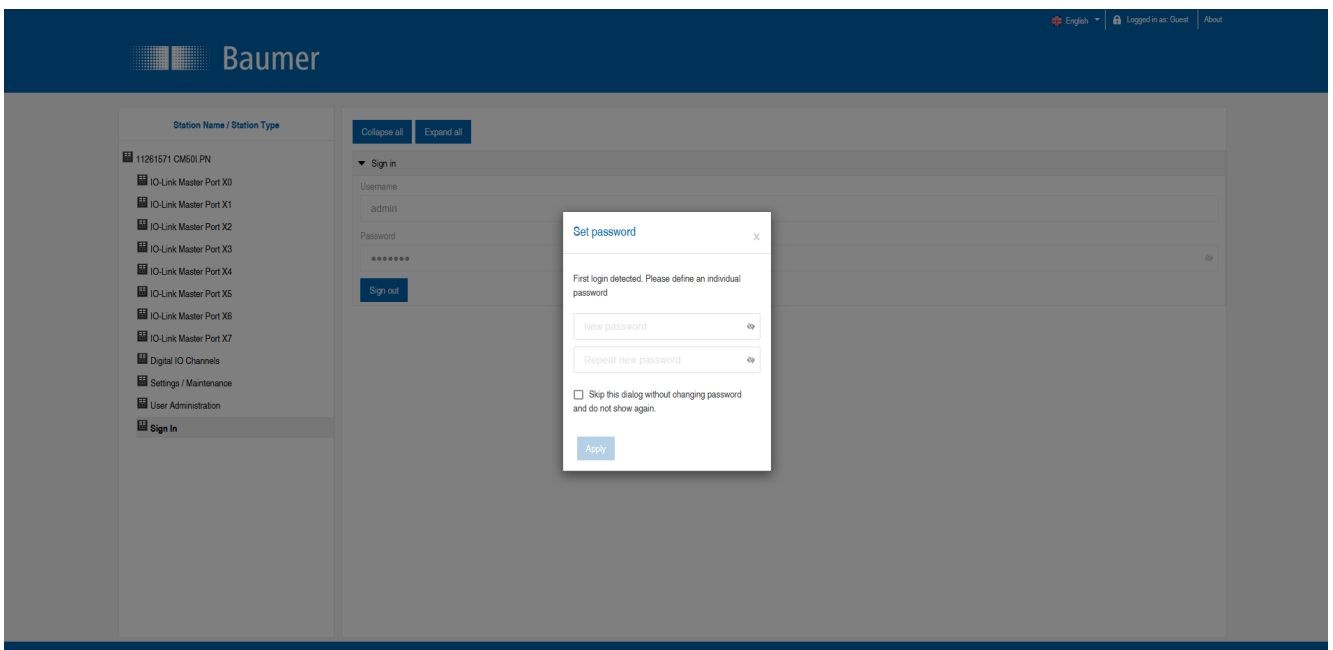

11.3 Initial screen

Operating areas

The web server provides 4 operating areas.

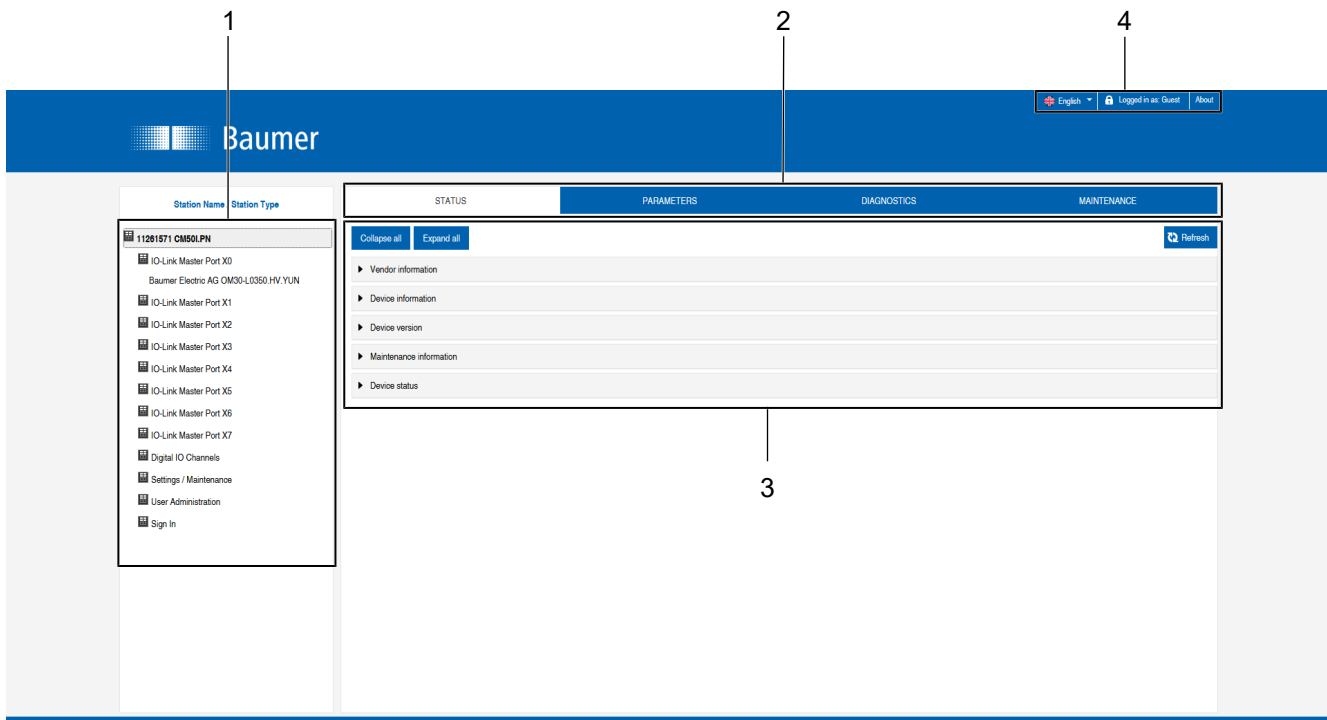

III. 35: Operating areas

1	System tree	Provides device and available sub functions.
2	Menu bar	The menu bar can be used to switch between the different pages of the device or the sub-function. In addition, the white highlighting indicates the page you are currently on.
3	Page content	This area displays the content of the selected page.
4	Header bar	Language and interface settings, system information.

11.4 Menu bar

The first line in the system tree provides device with article number and product name.

The menu bar comprises the following menu items:

- **Status**
- **Parameter**
- **Diagnostic tools**
- **Preventive maintenance**

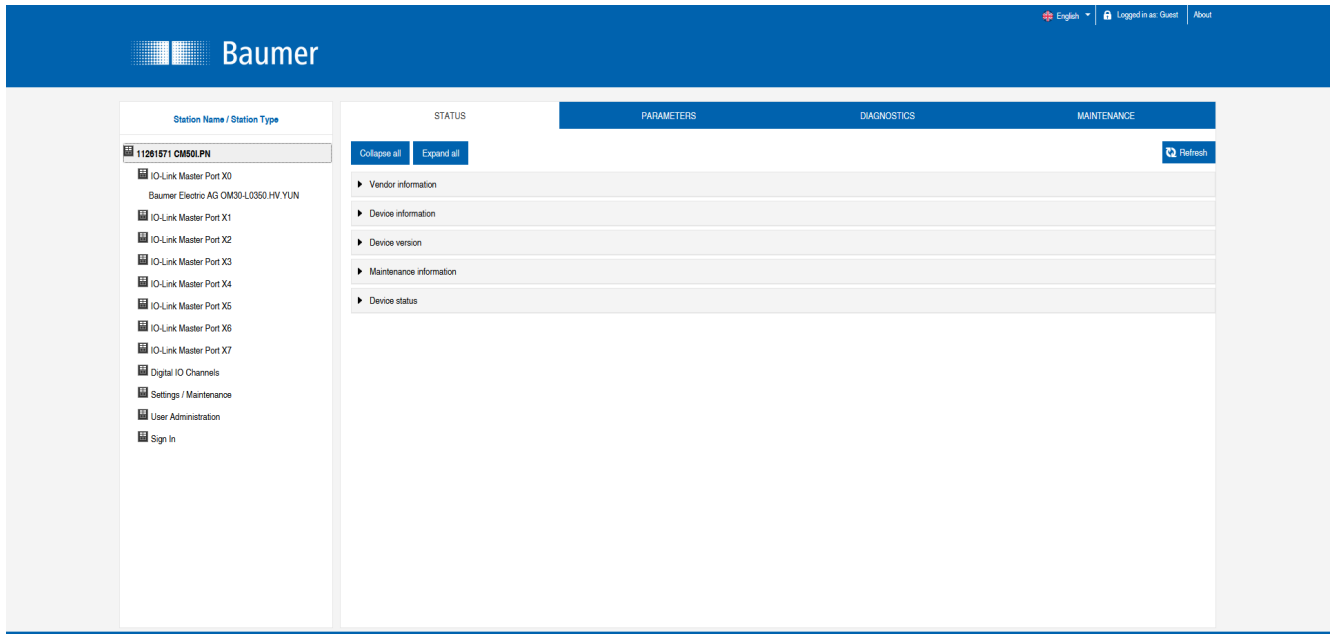

///. 36: Menu bar

11.4.1 STATUS menu

The **Status** menu item contains the following sub-items:

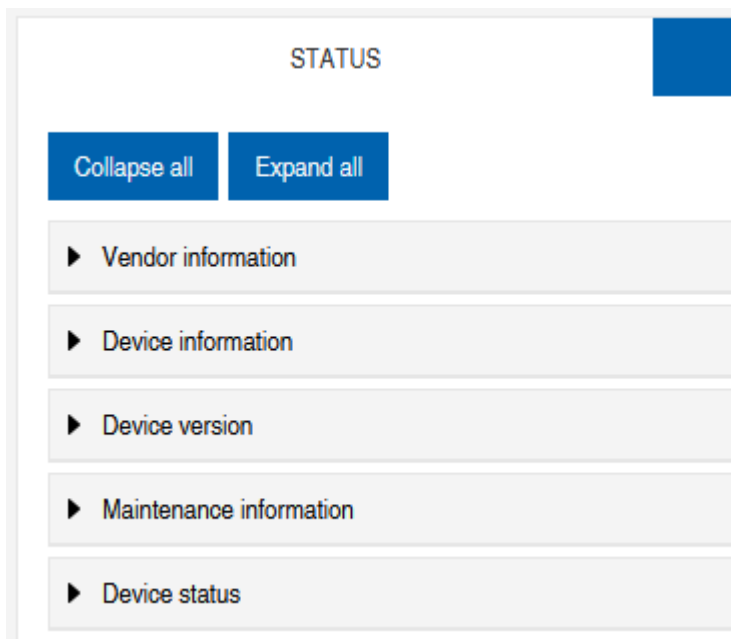

///. 37: **Status** menu item

Manufacturer information

Manufacturer information displays the following information:

Parameter designation	Description
Manufacturer name	Fixed data from the manufacturer
Manufacturer address	Fixed data from the manufacturer
Manufacturer telephone	Fixed data from the manufacturer
Manufacturer URL	Website of the manufacturer

Device information

Device information displays the following information:

Parameter designation	Description
Order number	Article number of the device
Hardware name	Permanent article number of the device
Software name	Fieldbus designation of the device
Software number	Device manufacturing number

Device version

Device version displays the following information:

Parameter designation	Description
Hardware version	Hardware execution version
Software version	Software version run in the device
Website version	Web server version currently run in the device

Maintenance information



INFO

Maintenance information is read only. The fields are entered or changed via **Settings/Maintenance | Maintenance information**.

Maintenance information provides the following information:

Parameter designation	Description
Name	Device name, free text
Installation location	Name of place, free text
Contact information	Contact, free text
Description	Description, free text
Last maintenance date (yyyy-mm-dd)	Free date entry
Next maintenance date (yyyy-mm-dd)	Free date entry

IO-Link device information

IO-Link device information displays the following information:

Parameter designation	Description
1L Voltage [V]	Provides sensor voltage in volts
1L Current [A]	Provides sensor voltage in amperes
2L Voltage [V]	Provides actuator voltage in volts
2L Current [A]	Provides actuator voltage in amperes
Temperature [°C]	Display of the appliance temperature in Celsius
Total operating time [hh:mm:ss]	Operating time since the device was switched on
Number of starts	Number of restarts

11.4.2 Menu PARAMETERS

The **Parameters** menu item contains the following sub-items:

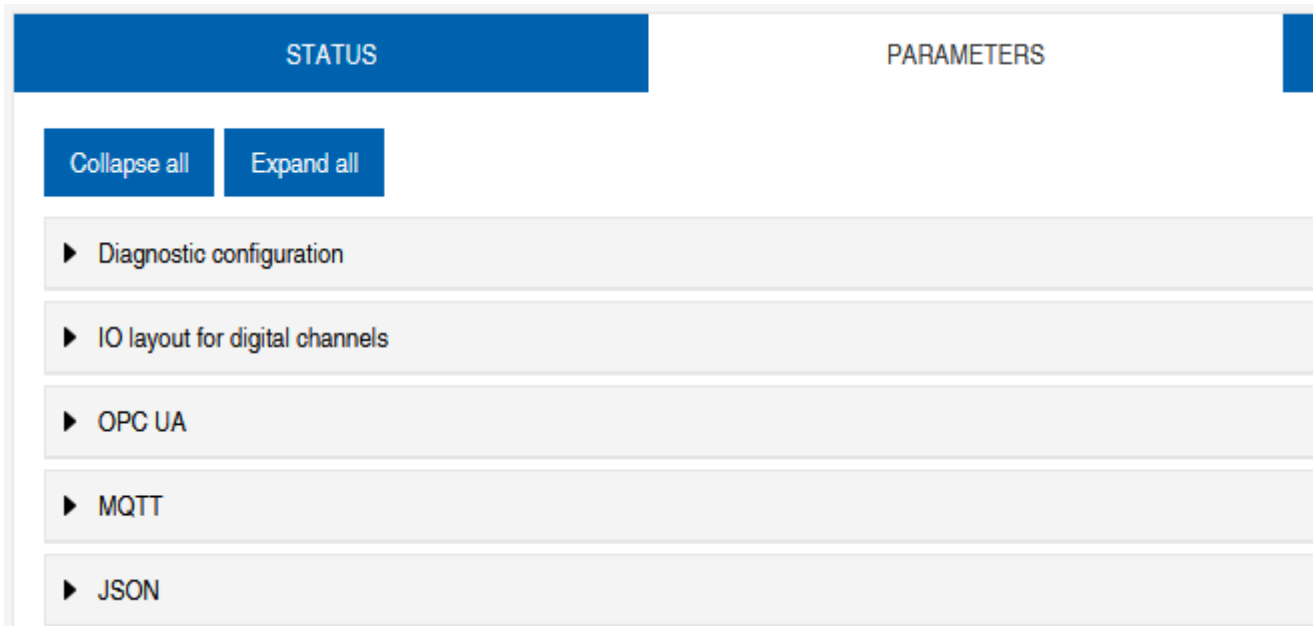

III. 38: **Parameter** menu

OPC UA

Users with admin and operator rights can change settings and enter the OPC UA port number. Guest users with read rights only.

OPC UA displays the following information:

Parameter designation	Description
Activate OPC UA Server	OPC UA server on the module active / passive
Allow OPC UA clients to write ISDU data	OPC UA client may write ISDU data (Indexed Service Data Unit) to the module on the IO-Link master
Allow OPC UA clients to write PDO data	OPC UA client may write PDO (process data objects) to the module on the IO-Link master
OPC UA port number	Display / definition of the OPC UA port

MQTT

Users with admin and operator rights can change settings and enter the IP address of the MQTT server. Guest users with read rights only.

MQTT displays the following information:

Parameter designation	Description
Enable MQTT	MQTT client on component active / passive
MQTT server IP address	MQTT server IP address
MQTT Client ID	Read/write MQTT client ID
Client head topic	Read/write MQTT topic
Topic for system data	Read/write MQTT topic

JSON

Users with admin and operator rights can activate and deactivate JSON. Guest users with read rights only.

JSON displays the following information:

Parameter designation	Description
Enable JSON	JSON interface on component active / passive

11.4.3 DIAGNOSTICS menu

The incoming and outgoing alarms of the master are displayed in the **Diagnositics** menu item.

The menu shows an overview of the diagnostic messages.

Depending on the setting in the **Please select an entry** drop-down menu, the following device diagnostics are displayed:

- **Enabled**
 - All pending diagnostics at the time of the web server call.
 - All diagnoses that no longer exist are not displayed.
- **History**
 - All diagnostics from the retentive diagnostics memory that no longer exist are displayed.
 - More than 40 diagnostics in the memory. The latest diagnostics overwrites the most previous one in the memory.

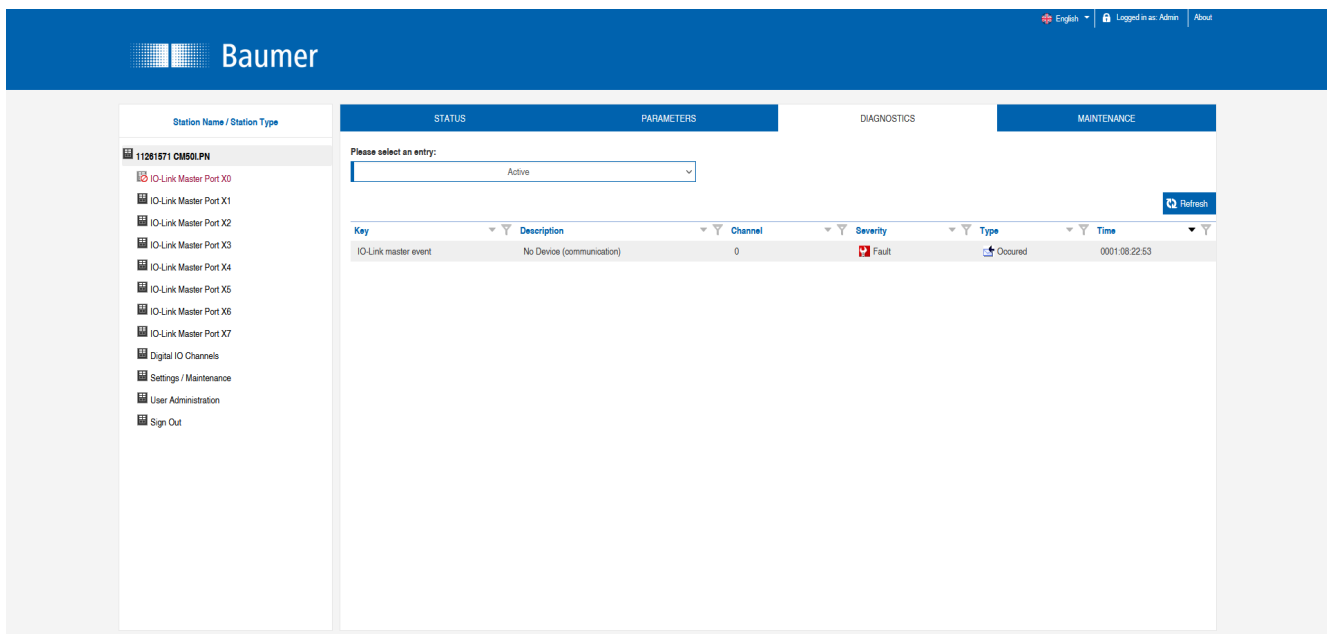

III. 39: **Diagnositics** menu item

11.4.4 MAINTENANCE menu

In the **Maintenance** menu item, users with admin and operator rights can delete the diagnostic memory.

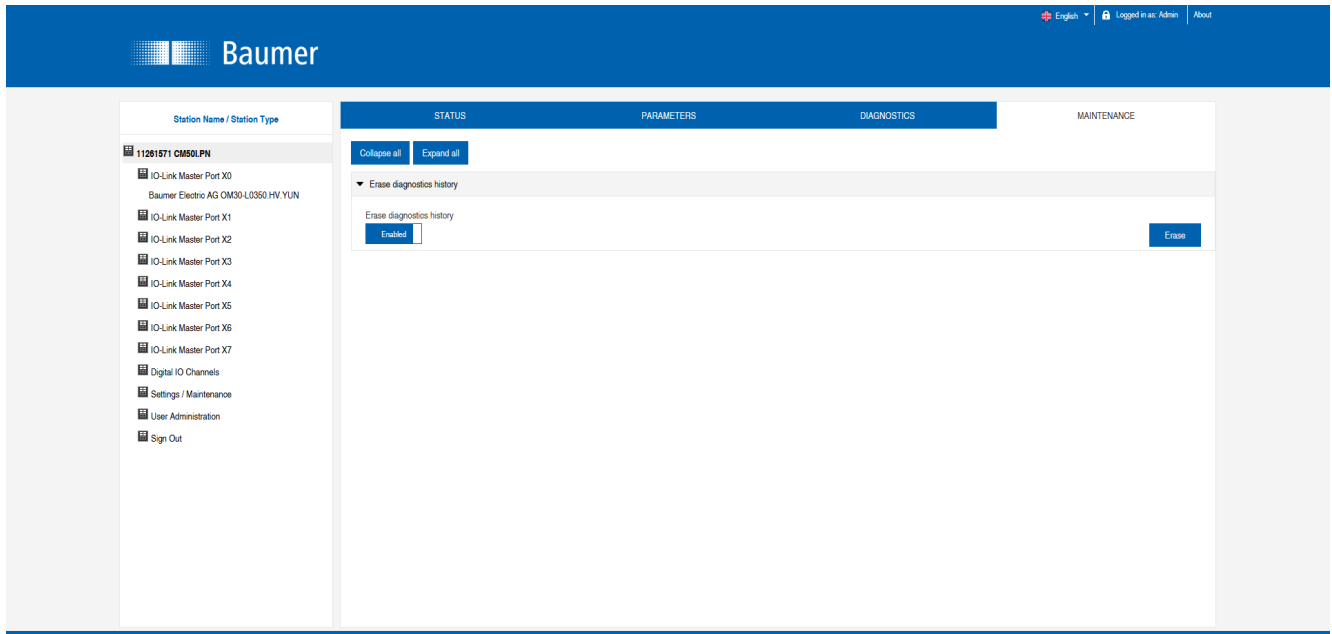

III. 40: Delete diagnostic memory

11.5 IO-Link master port

The system tree provides 8 IO-Link master ports (X0 ... X7) for individual selection. According to the user role, information is read only or enables configuration.

In active IO-Link communication, the IO-Link device name automatically appears under the relevant port.

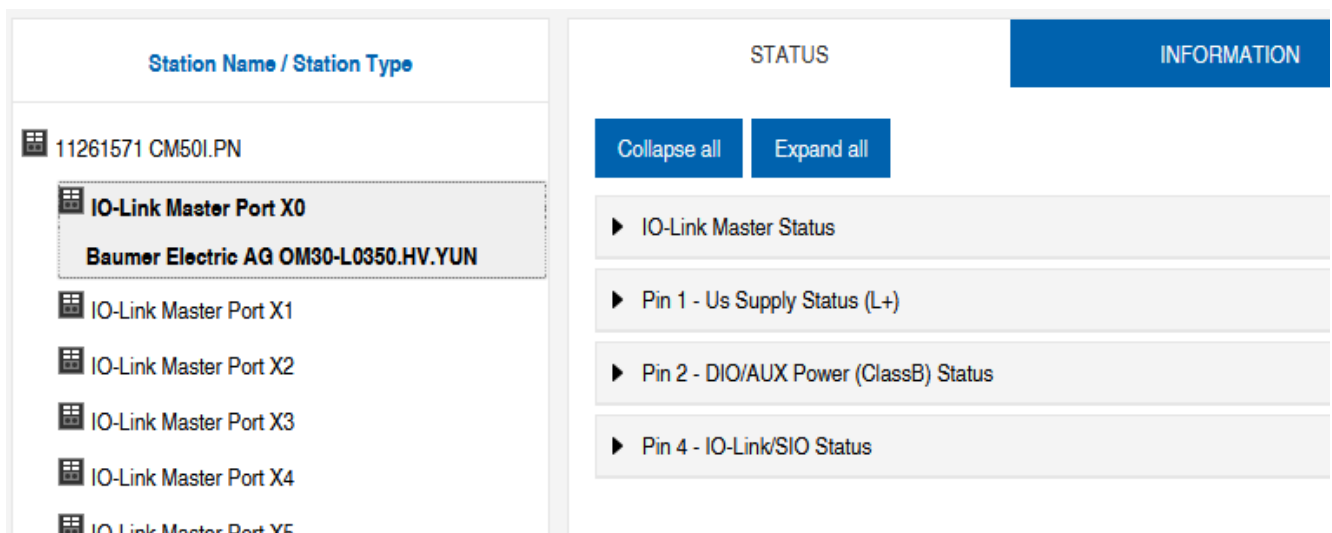

III. 41: IO-Link master port

11.5.1 STATUS menu

The IO-Link master status is displayed here in the **Status** menu.

The screenshot shows a web interface with three tabs: STATUS, INFORMATION, and CONFIGURATION. The STATUS tab is active. Below the tabs are two buttons: 'Collapse all' and 'Expand all'. A dropdown menu is open for 'IO-Link Master Status', displaying the following data:

- State	Operate
- Quality	0x2
- Revision ID	0x11
- Baudrate	230.4 kbps
- Cycle time	1.0 ms
- Input data length	6
- Output data length	1
- Vendor ID	0x15E
- Device ID	0x25F

III. 42: IO-Link master port - IO-Link master status

If pin 4 is in IO-Link mode, all relevant IO-Link data including the I/O bytes of the device are displayed.

If pin 4 is in operation without a connected IO-Link device, it is displayed that no device is connected.

The screenshot shows a web interface with a dropdown menu for 'IO-Link Master Status'. The menu is expanded to show the following data:

- Port function	Digital input
-----------------	---------------

III. 43: IO-Link master port - IO-Link master status for digital operation

If pin 4 is configured as a digital input, you can see it here.

Optional indication of:

- Status: Disabled
- Status: Digital input
- Status: Digital output

Port Status - Pin 1

Port status - pin 1 provides the following information

Parameter designation	Description
Temperature [°C]	Temperature in degrees Celsius
Voltage [V]	Voltage in Volts
Current [A]	Current in Ampere
Status	Pin status

Port Status - Pin 2

Port status - pin 2 provides the following information

Parameter designation	Description
Temperature [°C]	Temperature in degrees Celsius
Voltage [V]	Voltage in Volts
Current [A]	Current in Ampere
Status	Pin status

Port Status - Pin 4

Port status - pin 4 provides the following information

Parameter designation	Description
Temperature [°C]	Temperature in degrees Celsius
Voltage [V]	Voltage in Volts
Current [A]	Current in Ampere
Status	Pin status

11.5.2 INFORMATION menu

Menu item **Information** provides the following subitems:

STATUS	INFORMATION	CONFIGURATION	IO-LINK PARAM
Collapse all Expand all			
▼ IO-Link Device Information			
- Min cycle time	1.0 ms		
- Function ID	0		
- Number of profile IDs	1		
- Vendor name	Baumer Electric AG		
- Vendor text	www.baumer.com		
- Product name	OM30-L0350.HV.YUN		
- Product ID	11232075		
- Product text	Optical distance sensor, Connector M8		
- Serial number	R245.85343		
- Hardware revision	01.00.01		
- Firmware revision	01.01.09		

III. 44: IO-Link Master Port – **Information**

IO-Link device information

Technical data and manufacturer information of a connected and active IO-Link device is provided at the related master port.

“IO-Link device information” provides the following information:

Parameter designation	Description
Minimum. cycle time	Minimum process cycle time of IO-Link device
Function ID	Function ID IO-Link device
Number of profile IDs	Number of profiles supported by the IO-Link device
Manufacturer name	Manufacturer name IO-Link device

Parameter designation	Description
Manufacturer text	Manufacturer text IO-Link device
Product name	Product name IO-Link device
Product ID	Article number IO-Link device
Product text	Additional description IO-Link device
Serial number	Serial number
Hardware version	Hardware version
Firmware version	Firmware version

11.5.3 CONFIGURATION menu

Menu item **Configuration** of the selected IO-Link port provides the setting of pin 1, pin 2 and pin 4 and allows also for configuration.

Users with operator and admin rights can set the functions and behavior of pin 1, pin 2 and pin 4.

Users with service and maintenance rights have read rights.

Pin 4 can be deactivated or configured as an IO-Link master, input or output.

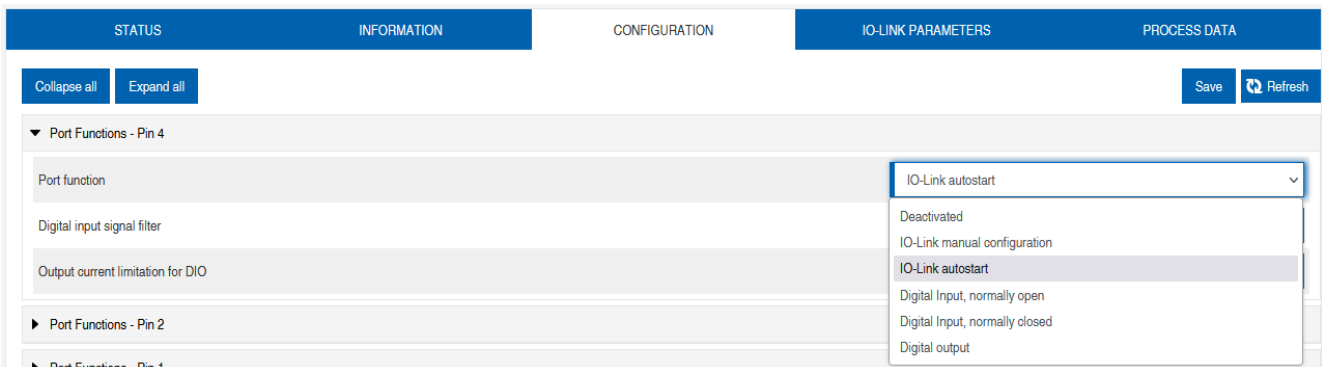

III. 45: IO-Link master port - configuration (pin 4)

Pin 2 can be deactivated or configured as an input, output or DIO in **Automatic Mode**.

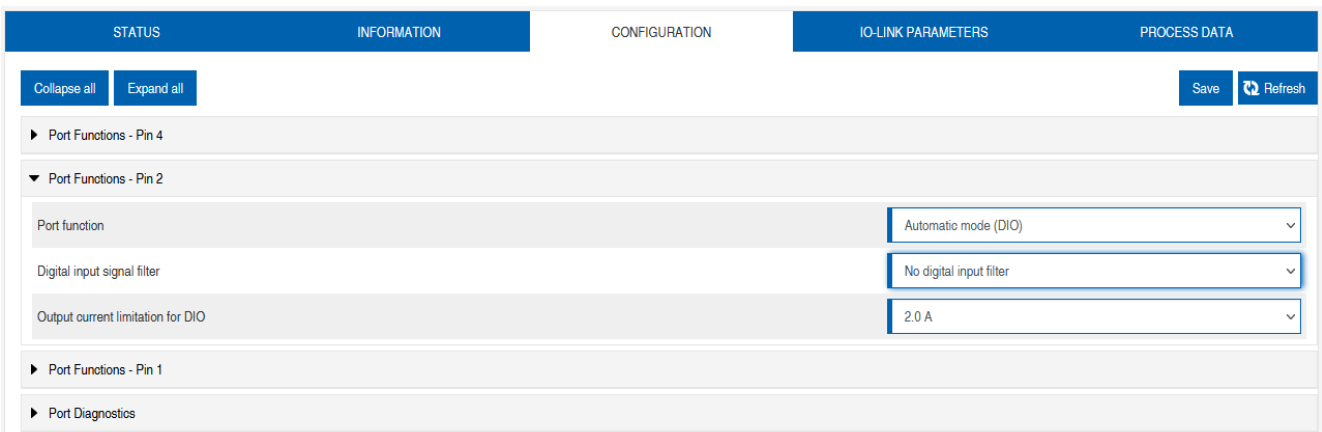

III. 46: IO-Link master port - Configuration - IQ behavior (pin 2)

If pin 2 or pin 4 is configured as an input, the digital input filters can be set individually.

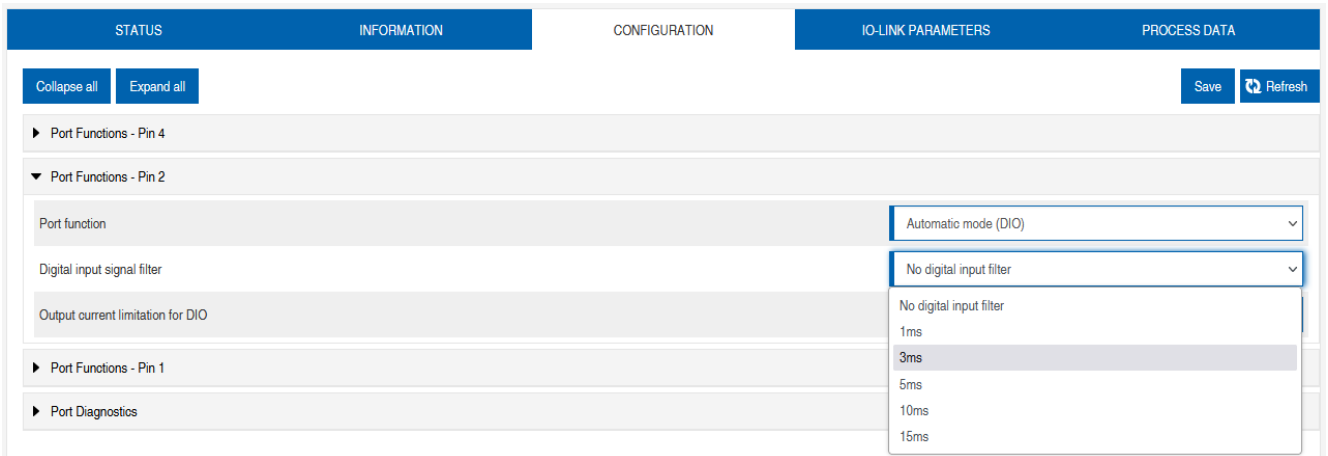

III. 47: IO-Link master port - Configuration - Setting digital input filters

11.5.4 IO-LINK PARAMETERS menu

In this menu item, the *ISDU (Index Service Data Unit)* of the device can be read and written during IO-Link operation. This primarily allows an IO-Link device to be evaluated or parameterized without a controller. The input can be made in both hex and ASCII format.



INFO

Observe the information in the IO-Link device manufacturer's manual.

Users with maintenance and admin rights can write ISDU values. Users with service rights have read rights.

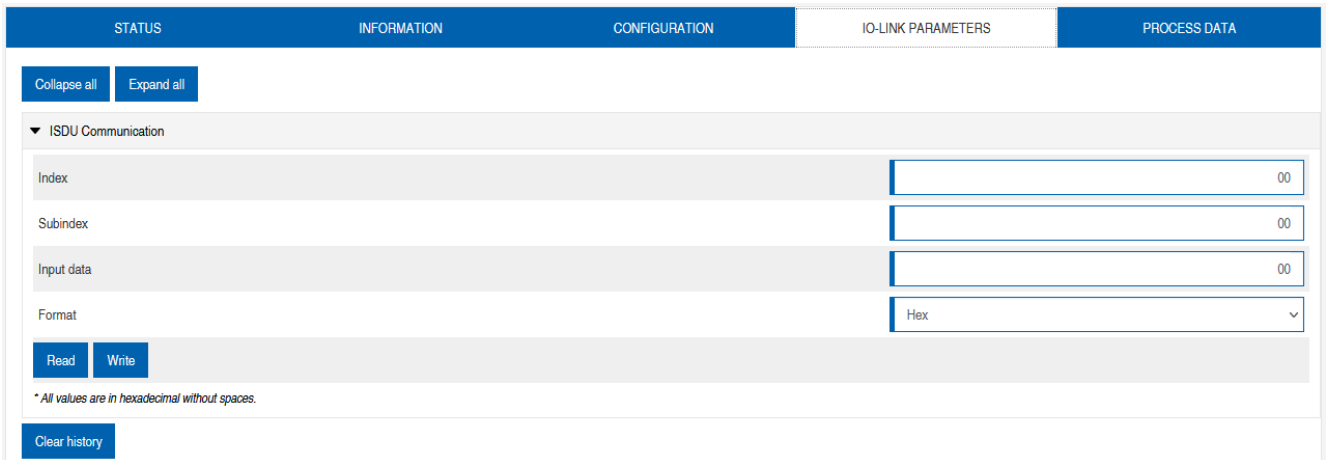

III. 48: IO-Link master port - IO-LINK PARAMETER

11.5.5 PROCESS DATA menu

In the **Process data** menu item, the current process data of the connected IO-Link device is continuously displayed if pin 4 of the corresponding port has been configured as an IOL port. Example: Port X2: Pin 4 (IO- Link Autostart) and Pin 2 (Digital output static on).

STATUS	INFORMATION	CONFIGURATION	IO-LINK PARAMETERS	PROCESS DATA
Collapse all Expand all				
▼ Process Data				
Pin 4 IOL Input				00,01,0f,42,fa,01
Pin 4 IOL Output				00
Force Pin 4 IOL Output Data			Write Disable Forcing	0
Pin 2 DO				0
Pin 2 DI				0
Format				Hexadecimal

III. 49: IO-Link Master Port - PROCESS DATA

The current statuses of the digital inputs are displayed in this menu item. Example: Port X1: Pin 4 (DI) and pin 2 (DI)

STATUS	CONFIGURATION	PROCESS DATA
Collapse all Expand all		
▼ Process Data		
Pin 4 DI		0
Pin 2 DO		0
Pin 2 DI		0
Format		Hexadecimal

III. 50: IO-Link master port - Digital inputs - PROCESS DATA

11.6 Digital IO channels/ IO overview

In the **Configuration** menu of the selected IO-Link port, the setting of pin 2 and pin 4 on the selected port is displayed. Outputs can be set under certain conditions.

11.6.1 Input data

Each user can monitor the digital statuses of the inputs configured on the device.

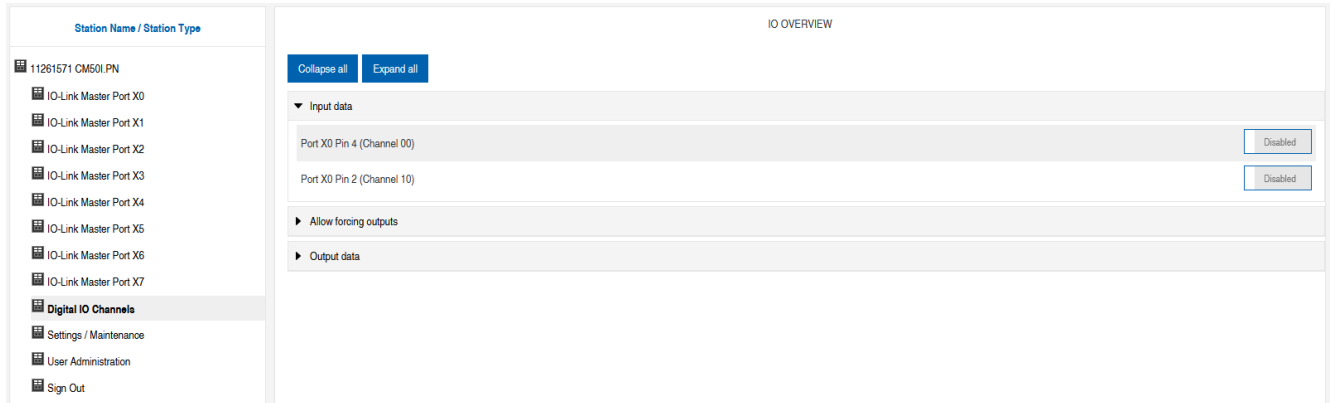

/// 51: Overview of input data

11.6.2 Output data

Allow outputs to be set

Users with admin, service and maintenance rights can allow the outputs to be set in this menu.

The right to do this is only granted if the device is not in an active fieldbus connection with the control unit. The control system has priority.

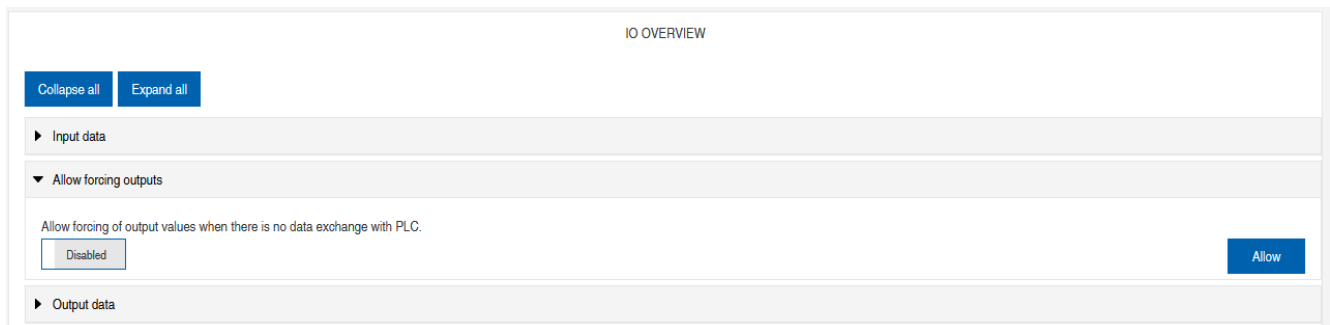

/// 52: Allow outputs to be set

Setting output data

Guest users are not permitted to set the exits.

All other users (admin, operator, maintenance) can set the outputs.

As soon as the user (admin, operator, maintenance) logs out, the outputs go to 0.

As soon as a fieldbus is actively working with the device, the outputs go to 0 and then adopt the status that they receive from the controller.

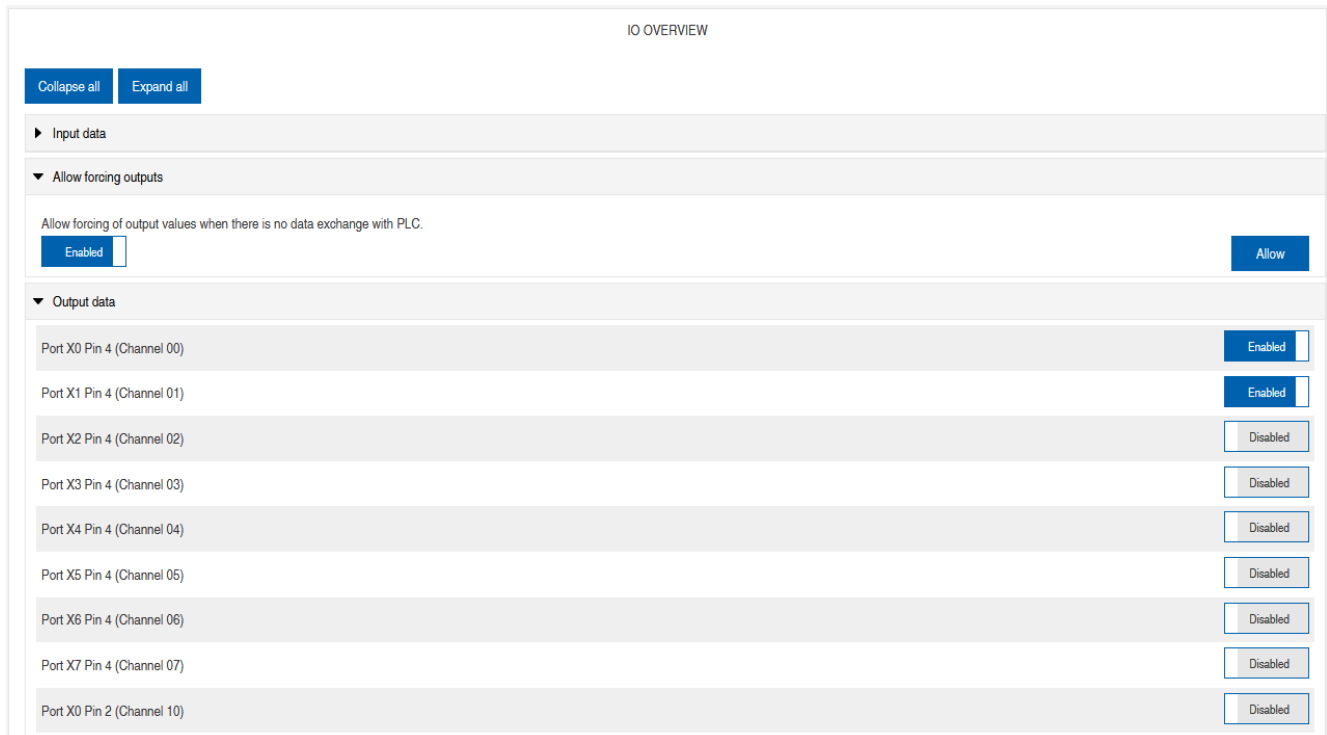

III. 53: Setting output data

11.7 Settings and maintenance

11.7.1 DEVICE CONFIGURATION menu

In Profinet, the address is usually assigned by the controller using DCP. Only the IP setting can therefore be read in the web server.

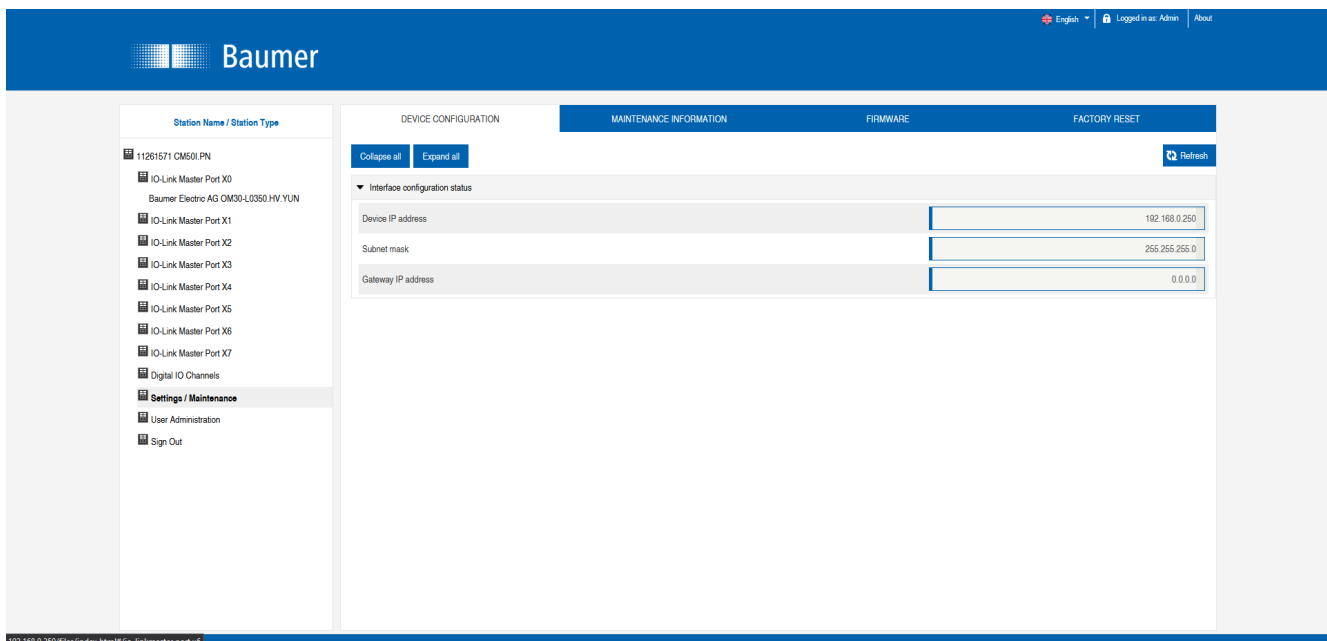

III. 54: Settings IP address Profinet

11.7.2 MAINTENANCE INFORMATION menu

Users with service, maintenance and admin rights can enter information about the device here.

The screenshot shows the 'MAINTENANCE INFORMATION' tab selected in the top navigation bar. The left sidebar lists various station types, with 'Settings / Maintenance' highlighted. The main content area contains a form for entering maintenance data. A yellow banner at the top of the form indicates 'Maintenance data changed'. The form fields are as follows:

Name	Station 123
Installation location	Hall 123
Installation date (yyyy-mm-dd)	2023-03-03
Contact information	Smith
Description	First Teststation
Last service date (yyyy-mm-dd)	2024-03-03
Next service date (yyyy-mm-dd)	2025-03-03

An 'Apply' button is located at the bottom left of the form, and a 'Refresh' button is at the top right.

III. 55: Maintenance information setting

The maintenance information appears in the device in the **Status** menu item and **Maintenance information** submenu.

The screenshot shows the 'STATUS' tab selected in the top navigation bar. The left sidebar is the same as in the previous image. The main content area displays the maintenance information as a read-only status view. The data is organized into sections:

- Vendor information
- Device information
- Device version
- Maintenance information (expanded):
 - Name: Station 123
 - Installation location: Hall 123
 - Contact information: Smith
 - Description: First Teststation
 - Last service date (yyyy-mm-dd): 2024-03-03
 - Next service date (yyyy-mm-dd): 2025-03-03
- Device status

'Collapse all' and 'Expand all' buttons are at the top left, and a 'Refresh' button is at the top right.

III. 56: Maintenance information status

11.7.3 FIRMWARE menu

This menu item displays the data of the firmware running on the device.

Users with service, maintenance and admin rights can upload new firmware, provided in ZIP folders, to the device here. After successful loading, the device checks the firmware container and starts automatically with the new firmware version.

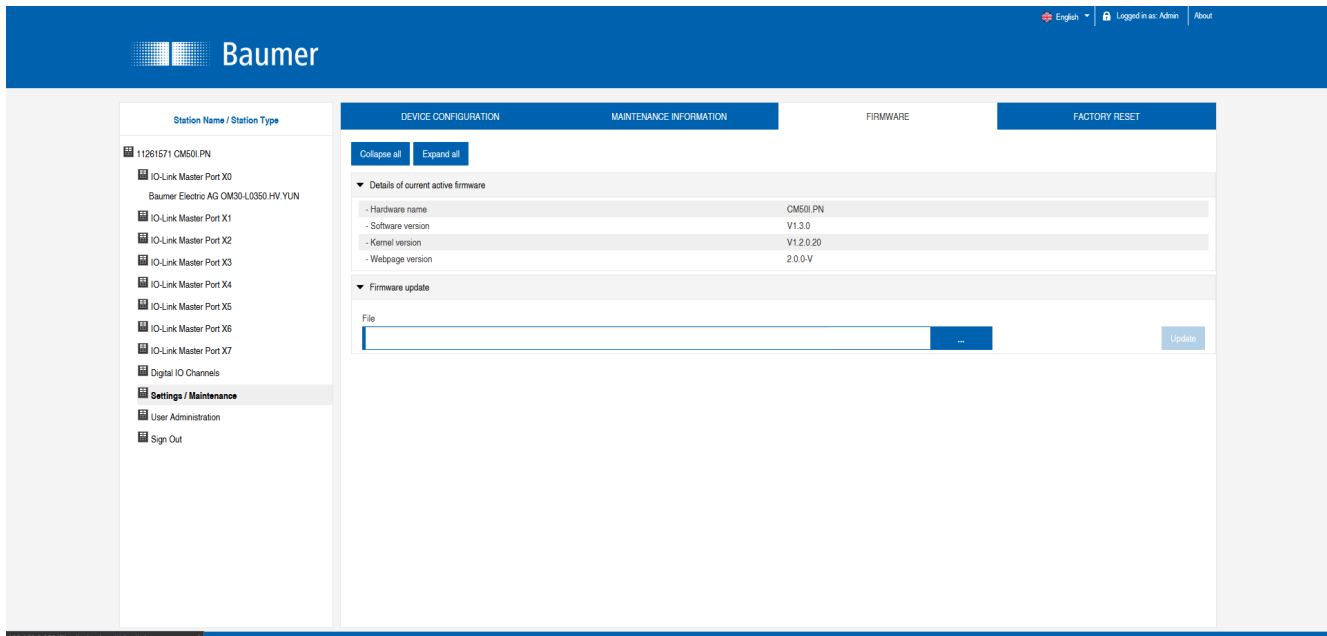

III. 57: Firmware

11.7.4 WORK RESET menu

In this menu item, users with service, maintenance and admin rights can reset the entire device or individual sub-areas (device information, network, application).

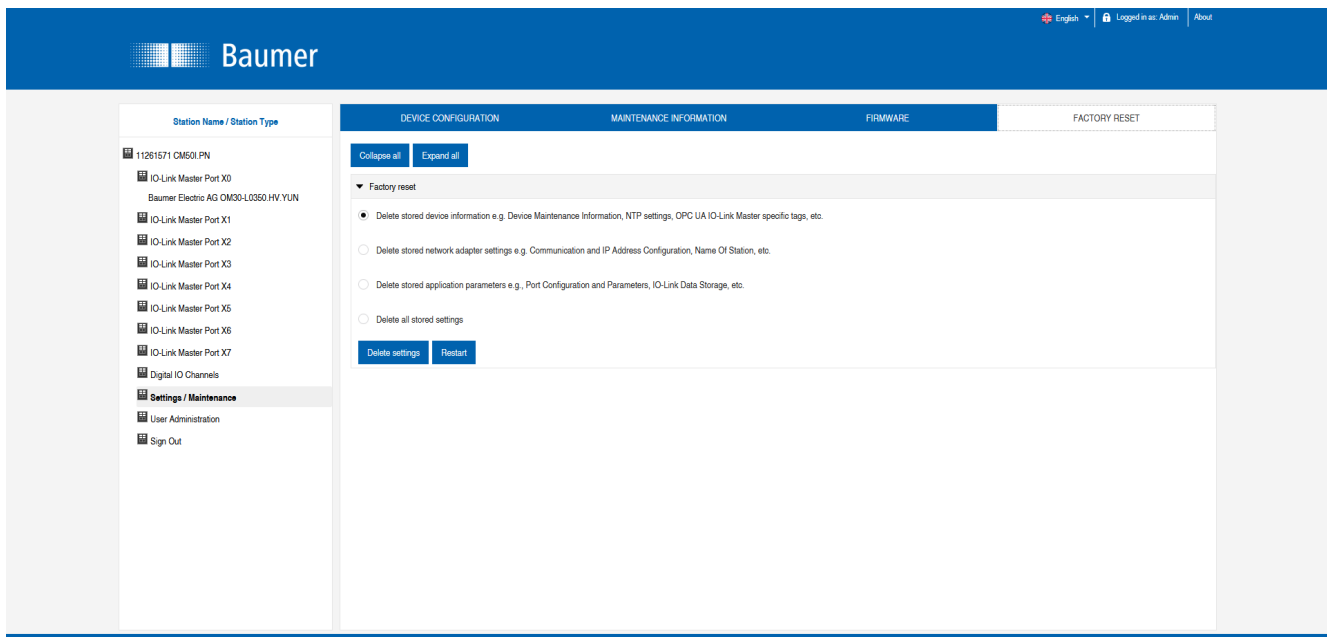

III. 58: Factory reset

11.8 User administration

User administration can only be carried out with admin rights.

Default at delivery uses `admin` as administrator with password `private`.



INFO

In the system with running fieldbus, the administrator default password can be edited at the control unit.

Users log in and off in the system tree at the bottom left.

- ◆ Click on **Logout**.

The screenshot shows the 'USER ADMINISTRATION' interface. On the left, a sidebar lists system components, with 'User Administration' highlighted. The main area contains a table of users and a form to add a new user.

Username	Userrole	Actions
Operator	Operator	
SamSmith	Maintenance	
admin	Admin	

Below the table is the 'Add new user' section with input fields for Username, Password, and Userrole (set to Operator), and an 'Add' button.

III. 59: User administration

12 Maintenance and cleaning

⚠ WARNING**Material damage due to defective or damaged appliances.**

The function of the devices is not guaranteed.

- a) Replace defective or damaged devices.
-

**INFO**

You can replace the device with the same type if maintenance is required.

- a) Check whether the switch settings of the old and new device are identical.
-

**INFO**

Cleaning the appliance.

- a) Only use oil-free compressed air or spirit.
 - b) Only use non-fibrous materials (e.g. leather cloth).
 - c) Do not use contact spray.
-

13 Annex

13.1 Supported EtherNet/IP objects

This chapter presents a list of the product- supported and implemented CIP objects and services. For more detailed descriptions of the individual objects and attributes please refer to the EtherNet/IP specification.

13.1.1 Standard object class

13.1.1.1 Identity Object (Class Code: 0x01)

Class attributes

Attribute ID	Access Rule	Name	Data Type	Attribute description	Value semantics
1	Get	Revision	UINT	Revision of this object	This attribute is currently assigned the value two (02). The value of this attribute is increased by 1 in updates that require a higher value.
2	Get	Max Instance	UINT	Maximum instance number of an object having been created at this device class level.	The highest instance number of an object created at this class hierarchy level. This attribute is currently assigned the value one (01).
6	Get	Max ID Class Attribute	UINT	ID number of the last class attribute in the class definition that was implemented in the device.	This attribute is assigned the value seven (07).
7	Get	Max ID Instance Attributes	UINT	ID number of the last instance attribute in the class definition that was implemented in the device.	The value of this attribute is different according to the product variant. This attribute is nine (09).

Tab. 57: Identity Object Class Attribute

Instance attributes

Attribute ID	Access Rule	Name	Data Type	Attribute description	Value semantics
1	Get	Vendor ID	UINT	Every vendor identifies by number	640
2	Get	Device Type	UINT	Indication of the general product type	12
3	Get	Product Code	UINT	Identification of a specific product from a specific vendor	Example: 11261573

Attribute ID	Access Rule	Name	Data Type	Attribute description	Value semantics
4	Get	Revision	STRUCT <i>of:</i>	Changing the element representing the identity object	
		Major Revision	USINT		1
		Minor Revision	USINT		1
5	Get	State	WORD	Overall information on the device status	
6	Get	Serial Number	UDINT	Device serial number	
7	Get	Product Name	SHORT_STRING	Human-readable designation	Example: CC50I.EIP
8	Get	State	USINT	Current device status as shown in the status transition diagram	

Tab. 58: Identity Object Instance Attributes

Common Services

Service Code	Implemented for		Service Name	Service title
	Class	Instance		
0x01	No	Yes	Get_Attribute_All	Retrieves a pre-defined list of these object attributes.
0x05	No	Yes	Reset	Retrieving the device reset service. Option 0 is for device restart. Option 1 retrieves a restore default operation in the device.
0x0E	Yes	Yes	Get_Attribute_Single	Returns the contents of the specified attribute.

Tab. 59: Common Services of Identity Object

13.1.1.2 Message Router Object (Class Code: 0x02)

Attributes in this object are not accessible.

13.1.1.3 Assembly Object (Class Code: 0x04)

Class attributes

Attribute ID	Access Rule	Name	Data Type	Attribute description	Value semantics
1	Get	Revision	UINT	Revision of this object	This attribute is currently assigned value one (01). This value will be increased by 1 in updates that require this value to be increased.

Tab. 60: Assembly Object Class Attribute

Instance attributes

Attribute ID	Access Rule	Name	Data Type	Attribute description
3	Set, Get	Data	ARRAY of BYTE	
4	Get	Size	UINT	Number of bytes in attribute 3

Tab. 61: Assembly Object Instance Attributes

Common Services

Service Code	Implemented for		Service Name	Service title
	Class	Instance		
0x0E	Yes	Yes	Get_Attribute_Single	Returns the contents of the specified attribute.
0x10	No	Yes	Get_Attribute_Single	Changes an attribute value.

Tab. 62: Common Services of Assembly Object

13.1.1.4 Connection Manager Object (Class Code: 0x06)

Ethernet Link Object Class Attributes

Attribute ID	Access Rule	Name	Data Type	Attribute description	Value semantics
1	Get	Revision	UINT	Revision of this object	This attribute is currently assigned value one (01). This value will be increased by 1 in updates that require this value to be increased.

Attribute ID	Access Rule	Name	Data Type	Attribute description	Value semantics
2	Get	Max Instance	UINT	Maximum instance number of an object having been created at this device class level.	The highest instance number of an object created at this class hierarchy level. This attribute is one (01).

Tab. 63: Ethernet Link Object Class Attributes

Instance attributes

This object does not implement any instance attributes.

Common Services

Service Code	Implemented for		Service Name	Service title
	Class	Instance		
0x0E	Yes	No	Get_Attribute_Single	Returns the contents of the specified attribute.

Tab. 64: Common Services of Ethernet Link Object.

13.1.1.5 Device Level Ring (DLR) Object (Class Code: 0x47)

Class attributes

Attribute ID	Access Rule	Name	Data Type	Attribute description	Value semantics
1	Get	Revision	UINT	Revision of this object	This attribute is currently assigned value one (01). This value will be increased by 1 in updates that require this value to be increased.

Tab. 65: Device Level Ring Object Class Attribute

Instance attributes

Attribute ID	Access Rule	Name	Data Type	Attribute description
1	Get	Network Topology	USINT	Current network topology mode
2	Get	Network State	USINT	Current network status

Attribute ID	Access Rule	Name	Data Type	Attribute description
10	Get	Active Supervisor Address	STRUCT of:	IP and/or MAC address of the active ring supervisor
			UDINT	IP address of the supervisor
			ARRAY of 6 USINTs	MAC address of the supervisor
12	Get	Capability Flags	USINT	Describes the DLR functions of the device

Tab. 66: Device Level Ring Object Instance Attribute

Common Services

Service Code	Implemented for		Service Name	Service title
	Class	Instance		
0x01	No	Yes	Get_Attribute_All	Retrieves a pre-defined list of these object attributes.
0x0E	Yes	Yes	Get_Attribute_Single	Returns the contents of the specified attribute.

Tab. 67: Common Services of Device Level Ring Object

13.1.1.6 Quality of Service Object (Class Code: 0x48)

Class Attribute

Attribute ID	Access Rule	Name	Data Type	Attribute description	Value semantics
1	Get	Revision	UINT	Revision of this object	This attribute is currently assigned value one (01). This value will be increased by 1 in updates that require this value to be increased.
2	Get	Max Instance	UINT	Maximum instance number of an object having been created at this device class level.	The highest instance number of an object created at this class hierarchy level. This attribute is one (01).

Tab. 68: Quality of Service Object Class Attribute

Instance attributes

Attribute ID	Access Rule	Name	Data Type	Attribute description
1	Set, Get	802.1Q Tag Enable	USINT	Enables or disables transmission of 802.1Q frames on CIP and IEEE 1588 messages
4	Set, Get	DSCP Urgent	USINT	DSCP value for top priority messages for CIP transport classes 0/1
5	Set, Get	DSCP Scheduled	USINT	DSCP value for planned priority messages for CIP transport classes 0/1
6	Set, Get	DSCP High	USINT	DSCP value for high priority messages for CIP transport classes 0/1
7	Set, Get	DSCP Low	USINT	DSCP value for low priority messages for CIP transport classes 0/1
8	Set, Get	DSCP Explicit	USINT	DSCP value for explicit CIP messages (transport class 2/3 and UCMM) as well as any other encapsulated EtherNet/IP message

Tab. 69: Quality of Service Object Instance Attribute

Common Services

Service Code	Implemented for		Service Name	Service title
	Class	Instance		
0x0E	Yes	Yes	Get_Attribute_Single	Returns the contents of the specified attribute.

Service Code	Implemented for		Service Name	Service title
	Class	Instance		
0x10	No	Yes	Get_Attribute_Single	Changes the attribute contents of the class or object.

Tab. 70: Common Services of Quality of Service

13.1.1.7 TCP/IP Interface Object (Class Code: 0xF5)

Class Attribute

Attribute ID	Access Rule	Name	Data Type	Attribute description	Value semantics
1	Get	Revision	UINT	Revision of this object	This attribute is currently assigned value one (01). This value will be increased by 1 in updates that require this value to be increased.
2	Get	Max Instance	UINT	Maximum instance number of an object having been created at this device class level.	The largest instance number of a created object in this class hierarchy level. This attribute is one (01).

Tab. 71: TCP/IP Interface Object Class Attribute

Instance Attribute

Attribute ID	Access Rule	Name	Data Type	Attribute description
1	Get	Status	USINT	Interface status
2	Get	Configuration Capability	USINT	Interface capability flags
3	Set, Get	Configuration Capability	USINT	Interface control flags
4	Get	Physical Link Object	STRUCT of	Path to physical link object
		Path size	UINT	Path size
		Path	Padded EPATH	Logical segments that identify the physical link object
5	Set, Get	Interface Configuration	STRUCT of	TCP/IP network interface configuration.
		Set, Get	UDINT	IP device address
		Network Mask	UDINT	Network mask of the device

Attribute ID	Access Rule	Name	Data Type	Attribute description
		Gateway Address	UDINT	Default gateway address
		Name Server	UDINT	Primary name server
		Name Server 2	UDINT	Secondary name server
		Domain Name	STRING	Default domain name
6	Set, Get	Host Name	STRING	Host name
10	Set, Get	SelectAcd	BOOL	Activates ACD use
11	Set, Get	LastConflictDetected	STRUCT of	Structure including information on the last identified conflict
		AcdActivity	USINT	ACD activity status at the time the last conflict was identified
		RemoteMAC	Array of 6 USINT	MAC address of a remote node of ARP PDU in which the conflict was identified
		ArpPdu	ARRAY of 28 USINT	Copy of the raw ARP PDU in which the conflict was identified
12	n.c.			
13	Get	Encapsulation Inactivity Timeout	UINT	Number of seconds of inactivity prior to closing TCP connection or DTLS session

Tab. 72: TCP/IP Interface Object Instance Attribute

Common Services

Service Code	Implemented for		Service Name	Service title
	Class	Instance		
0x01	No	Yes	Get_Attribute_All	Retrieves a predefined list of these object attributes.
0x0E	Yes	Yes	Get_Attribute_Single	Returns the contents of the specified attribute.
0x10	No	Yes	Set_Attribute_Single	Changes a specific attribute.

Tab. 73: Common Services of TCP/IP Interface Object

13.1.1.8 EtherNet/IP Link Object (Class Code: 0xF6)

Class attributes

Attribute ID	Access Rule	Name	Data Type	Attribute description	Value semantics
1	Get	Revision	UINT	Revision of this object	The value four (04) is currently assigned to this attribute. This value will be increased by 1 in updates that require this value to be increased.
2	Get	Max Instance	UINT	Maximum instance number of an object having been created at this device class level.	The largest instance number of a created object at this class hierarchy level. This attribute presents two (02).
3	Get	Number of Instances	UINT	Number of object instances currently created at this class level of the device.	Number of object instances in this class hierarchy level. This attribute presents two (02).

Tab. 74: Ethernet Link Object Class Attributes

Instance attributes

Attribute ID	Access Rule	Name	Data Type	Attribute description
1	Get	Interface Speed	USINT	Interface speed
2	Get	Interface Flags	USINT	Interface status flags
3	Get	Physical Address	USINT	MAC layer address
4	Get	Interface Counters	STRUCT of	
		In Octets	UDINT	Octets received at the interface

Attribute ID	Access Rule	Name	Data Type	Attribute description
		In Ucast Packets	UDINT	Unicast packets received at the interface
		In NUcast Packets	UDINT	Non-unicast packets received at the interface
		In Discards	UDINT	Incoming packets received at the interface but discarded
		In Errors	UDINT	Incoming packets that contain errors (excluded in discards)
		In Unknown Protos	UDINT	Incoming packets with unknown protocol
		Out Octets	UDINT	Octets transmitted to the interface
		Out Ucast Packets	UDINT	Unicast packets transmitted to the interface
		Out NUcast Packets	UDINT	Non-unicast packets transmitted to the interface
		Out Discards	UDINT	Outgoing packets discarded
		Out Errors	UDINT	Outgoing packets that contain errors
5	Get	Media Counters	STRUCT of	Media-specific counters
		Alignment Errors	UDINT	Frames received that do not include complete octets only
		FCS Errors	UDINT	Frames received that did not pass FCS check
		Single Collisions	UDINT	Successfully transmitted frames that have suffered exactly one collision

Attribute ID	Access Rule	Name	Data Type	Attribute description
		Multiple collisions	UDINT	Successfully transmitted frames that have suffered more than one collision
		SQE Test Errors	UDINT	Number of error messages generated by SQE test
		Deferred Transmissions	UDINT	Frames where transmission is delayed by busy medium
		Late Collisions	UDINT	Number of events a collision was identified later than after transmission of 512 bits of the packet
		Excessive Collisions	UDINT	Frames with failed transmission due to excessive collisions
		MAC Transmit Errors	UDINT	Frames with failed transmission due to internal transmission error in the MAC sublayer
		Carrier Sense Errors	UDINT	Number of failed or not completed carrier checks when attempting frame transmission
		Frame Too Long	UDINT	Frames exceeding the maximum permitted size
		MAC Receive Errors	UDINT	Frames not received at the interface due to internal reception error in the MAC sublayer
6	Set, Get	Interface Control	STRUCT of	Configuration of the physical interface

Attribute ID	Access Rule	Name	Data Type	Attribute description
		Control Bits	WORD	Interface control bits
		Forced Interface Speed	UINT	Speed for interface operation
7	Get	Interface Type	USINT	Twisted pair, fiber, internal, etc.
8	Get	Interface State	USINT	Current interface status: in operation, disabled, etc.
9	Set, Get	Admin State	USINT	Administrative status: enabled, disabled
10	Set, Get	Interface Label	SHORT_STRING	Human-readable designation
11	Get	Interface Capability	STRUCT of	Display of interface capabilities
		Capability Bits	DWORD	Interface capabilities other than speed and duplex
		Speed/Duplex Options	STRUCT of	Indicates speed and duplex pairs supported by the interface control attribute
			USINT	Speed / duplex array counter
			ARRAY of STRUCT of	Speed / duplex array
			UINT	Interface speed
			UINT	Interface duplex mode

Tab. 75: Ethernet Link Object Instance Attribute

Common Services

Service Code	Implemented for		Service Name	Service title
	Class	Instance		
0x01	No	Yes	Get_Attribute_All	Retrieves a predefined list of these object attributes.
0x0E	Yes	Yes	Get_Attribute_Single	Returns the contents of the specified attribute.

Service Code	Implemented for		Service Name	Service title
	Class	Instance		
0x4C	No	Yes ¹⁾	Set_Attribute_Single	Changes a specific attribute.

Tab. 76: Common Services of TCP/IP Interface Object

¹⁾ The Get_and_Clear service is only implemented for the attributes 4 and 5.

13.1.2 Vendor specific objects

13.1.2.1 IO-Link Device Parameter Object (Class Code 0x83)

Class attributes

Attribute ID	Access Rule	Name	Data Type	Attribute description	Value semantics
1	Get	Revision	UINT	Revision of this object	This attribute is currently assigned value one (01). This value will be increased by 1 in updates that require this value to be increased.
2	Get	Max Instance	UINT	Maximum instance number of an object having been created at this device class level.	Largest instance number of an object created at this class hierarchy level. This attribute indicates one (01).
6	Get	Max ID Class Attribute	UINT	The ID number of the last class attribute of the class definition that was implemented in the device.	This attribute is assigned the value seven (07).
7	Get	Max ID Instance Attributes	UINT	ID number of the last instance attribute in the class definition that was implemented in the device.	The value of this attribute is different according to the product variant. Part number 55143 has number 2 and part number 55144 has number 4.

Tab. 77: IO-Link Device Parameter Object Class Attribute

Instance attributes

Instance attributes are not supported.

Object-Specific Services

The following class-specific services are defined for the IO-Link device parameter object.

Service Code	Implemented for		Service Name	Service title
	Class	Instance		
0x4B	No	Yes	Read_ISDU	Read parameters in IO-Link device in raw format, i.e. Big Endian
0x4C	No	Yes	Write_ISDU	Write parameters to the IO-Link device in raw format, i.e. Big Endian

Tab. 78: Common services of Object-Specific Services

Read_ISDU Service

Name	Data Type	Description
Index	UINT	IO-Link device index
Sub index	USINT	IO-Link device subindex

Tab. 79: Read_ISDU Service structure

Write_ISDU Service

Name	Data Type	Description
Index	UINT	IO-Link device index
Sub index	USINT	IO-Link device subindex
Data	ARRAY of USINT	IO-Link device ISDU data

Tab. 80: Write_ISDU Service structure

13.2 Process data explanations

13.2.1 Digital Input

The sequence of the digital input data depends on configuration parameter "Pin_Port_based_IO_Layout". For explanations see the following tables:

Port Based

Byte	1								0							
Bit	7	6	5	4	3	2	1	0	7	6	5	4	3	2	1	0
Port	X7	X7	X6	X6	X5	X5	X4	X4	X3	X3	X2	X2	X1	X1	X0	X0
Pin	2	4	2	4	2	4	2	4	2	4	2	4	2	4	2	4
Channel	17	07	16	06	15	05	14	04	13	03	12	02	11	01	10	00

Tab. 81: Port Based

Pin Based

Byte	1								0							
Bit	7	6	5	4	3	2	1	0	7	6	5	4	3	2	1	0
Port	X7	X7	X6	X6	X5	X5	X4	X4	X3	X3	X2	X2	X1	X1	X0	X0
Pin	2	2	2	2	2	2	2	2	4	4	4	4	4	4	4	4
Channel	17	16	15	14	13	12	11	10	07	06	05	04	03	02	01	00

Tab. 82: Pin Based

**INFO**

Tables Port- and Pin Based also apply to Digital Input Qualifier, Digital Output Qualifier and Digital Output.

13.2.2**DI-Qualifier**

The digital input qualifiers provide quick information on the input signal integrity.

Bit value	Description
0	Invalid
1	Valid

**INFO**

Bit sequence depends on configuration parameter *Pin_Port_based_IO_Layout*.

13.2.3**System status**

The system status bit bar provides overall device information.

Byte	Description
0 ... 3	Bit 0: Undervoltage bus/sensor supply Bit 1: Undervoltage actuator supply Bit 2: No actuator supply Bit 3: Reserved Bit 4: Sensor short-circuit at least in one channel Bit 5: Actuator short-circuit at least in one channel Bit 6: Reserved Bit 7: Reserved Bit 8: Reserved Bit 9: Error occurred in at least one IO-Link channel (except for broken wire) Bit 10: Overvoltage bus/sensor supply Bit 11: Actuator supply overvoltage Bit 12: At least one IO-Link channel has a broken wire Bit 13 ... 31: Reserved, set to 0

Tab. 83: System status bit bar

13.2.4 IO-Link port X status

Byte	Description	Value
0 ... 1	IO-Link Data Status	Bit 0 - 4: reserved Bit 5: DevCom, set when being in status PREOPERATE or OPERATE and a device has been identified. Will be reset if no device is available. Bit 6: DevErr, set if a warning or error has occurred that is assigned either to a device or a port. Will be reset if no error or warning is present. Bit 7: PQ, is set in valid process data exchange between master and device. Will be reset if process data is not valid.
2 ... 3	Vendor ID of connected IO-Link Device	
4 ... 7	Device ID of connected IO-Link Device	

Tab. 84: IO-Link port X status

13.2.5 Diagnostic Buffer

The diagnostic buffer consists of an array of diagnostic structures and has a length of 8 structures. A single diagnostic structure comprises 8 bytes. Total length of the diagnostic buffer is 64 bytes.



INFO

For further information on a diagnostic structures see [Diagnostic structure in the control unit \[▶ 79\]](#)

13.2.6 Digital Output



INFO

Bit sequence depends on configuration parameter *Pin_Port_based_IO_Layout*.

13.3 Accessories

13.3.1 Tools

Designation	Art. no.
M12 installation wrench set SW 13	11238694
M12 mounting wrench bit SW 17	11238695



III. 60: Assembly wrench



INFO PRODUCTS AND ACCESSORIES

You will encounter a large product selection at: <https://www.baumer.com>

13.4

Glossary

Term	Significance
AoE	ADS over EtherCAT
Bus-Run-LED	LED for signaling the bus status.
CfgF-LED	LED for signaling correct/incorrect configuration.
Byte	iTerm from IEC 61158. Corresponds to 1 byte or 8 bits.
DHCP	Dynamic Host Configuration Protocol DHCP enables dynamic server distribution of IP address and configuration information to clients. As a rule, the DHCP server provides the client with at least this basic information: <ul style="list-style-type: none"> ▪ IP address ▪ Subnet mask ▪ Standard gateway
CIP	Common Industrial Protocol Common Industrial Protocol is an application protocol of automation technology. It supports fieldbus transition into networks of industrial Ethernet and IP. This industrial protocol utilizes EtherNet/IP in the application layer as interface between fieldbus and control unit, I/O, etc.
CoE	CANopen over EtherCAT
DI	Digital Input
DIP switch	Dual in-line package/switch with two parallel rows of connections.
DO	Digital output/digital output
EDS	Electronic Data Sheet (electronic data sheet) EDS files are external files with device information. EDS files provide the necessary information for device parameter access to change configuration.

Term	Significance
EMCY	Emergency messaging
EMC	Electromagnetic compatibility
EN	European standard
EoE	Ethernet over EtherCAT
ESD	Electrostatic discharges
ESI-File	Device description (EtherCAT-Slave-Information) in the form of an XML file provided by the manufacturer.
ESM	The EtherCAT slaves status control is via EtherCAT-State-Machine. According to the status, several functions can be accessed or executed in the EtherCAT slave. Particularly during slave start-up, different stages require transmission of specific commands by the EtherCAT master.
ETG	EtherCAT Technology Group ETG is the world's largest international user and manufacturer association for Industrial Ethernet.
EtherCAT	Ethernet for Controller and Automation Technology EtherCAT was originally developed by the company Beckhoff Automation GmbH and is now supported and further developed by EtherCAT Technology Group (ETG).
EtherCAT-Master	The EtherCAT master is the I/O controller. It must support MDP.
EtherNet/IP	Ethernet Industrial Protocol Open standard for industrial networks supporting cyclic and acyclic message transmission and operating on standard Ethernet communication chips and physical media.
Ethernet-Frame	Every Ethernet frame (data packet) comprises sender address (source) and recipient address (destination). When receiving a frame, the recipient's receiving unit compares the MAC destination address against its own MAC address. The frame content is only passed to the higher level if the addresses match. If they don't, the frame is discarded.
FE	Functional earth
FMMU	Fieldbus Memory Management Unit
FoE	File access over EtherCAT
IGMP	Internet Group Management Protocol (IGMP) is a network protocol of the Internet protocol family to organize multicast groups. IGMP uses Internet Protocol (IP) as a part of IP on all hosts supporting IP multicast reception.
IIoT	The Industrial Internet of Things (IIoT) is the industrial version of the Internet of Things (IoT). In contrast to the IoT, it does not represent consumer-oriented concepts, but focuses on the application of the Internet of Things in the manufacturing and industrial environment.
IN	Input
I&M data	For identification and maintenance (I&M), data records (data structures) have been defined for PROFIBUS, which must be implemented for all devices with DP-V1. These data structures are used to uniquely identify the field device and facilitate maintenance.

Term	Significance
IO-Link IOL	Standardized communication system for connecting intelligent sensors and actuators to an automation system
IRT	Isochronous real time/protocol for clock-synchronous activation of data and functions on different devices.
IP	Internet Protocol Protocol used for data transmission within a network, e.g. from one computer to another within the internet or intranet. Every computer in the network is unambiguously identified by its IP address. In data transmission from one computer to another, data is broken down into small packets of information, each including the addresses of both sender and recipient. These packets may arrive at their destination in different ways via the network and also in different order. A specific protocol, the so-called Transmission Control Protocol [TCP] restores the correct packet order.
IP67	Ingress protection according to DIN EN 60529
IP address	Address for identification in an Ethernet network
LED	Light Emitting Diode
LNK/ACT-LED	Link/Activity LED for signaling Ethernet communication.
MAC address	Media Access Control Address Hardware address of network components used for unambiguous identification within the network.
MDP	Modular Device Profile (Modular device profile)
MQTT	Client-server protocol
MRP	Media Redundancy Protocol/A protocol for the management of ring topologies in a production plant. It is used to increase the availability of devices in the network.
n.c.	Not connected
ODVA	ODVA is an international association for open and compatible information and communication technologies in automation technology. e.g. EtherNet/IP, DeviceNet, CompoNet and ControlNet,....
OUT	Output
PDO	Process data objects are user data expected in the application or transmitted to slave.
PELV	Protective Extra Low Voltage
Power LED	LED for signaling the power supply
PROFINET	Process Field Network
PROFenergy	PROFINET profile for energy management in production plants
PQI	The port qualifier information (PQI) provides status information about the IO-Link port or the device status.
RPI	Requested packet interval The interval at which the EtherNet/IP target is transmitting process data to scanner.
SDO	Service Data Objects
SELV	Safety Extra Low Voltage with safe isolation.

Term	Significance
Shared Device (SD)	Protocol extension of a PNIO device to establish simultaneous communication relationships with several PNIO controllers.
SNMP	Simple Network Management Protocol/Protocol for simple monitoring and control of various network participants.
PLC	Programmable Logic Controller
UA	Actuator voltage
US	Sensor voltage
Validation IO-Link	Check for compatibility or identity of a connected IO-Link device.

