

Vue d'ensemble

- M12, female, A-coded, 8-poles; PUR, 500 cm, shielded, free cable end
- Dragchain capable
- Head A: IP65, IP66K, IP67
- Cable: good resistance against chemicals, flames, oils
- Halogen free



Caractéristiques techniques

Side A		Cable	
Head A: Connection	M12	Number and diameter of wires	8x0,25
Head A: Angle cable outlet	90°	Length tolerance	± 7,5 cm
Head A: Gender	Female	Cable length	500 cm
Head A: Coding	A	Acceleration (C-track)	max. 5 m/s ²
Head A: No. of poles	8	AWG	24
Head A: LED	No	Bending radius (fixed)	min. 5 × outer diameter
Head A: Width across flats	AF13	Torsion speed	max. 35 cycles/min
Head A: Tightening torque	0,6 Nm	Bending radius (mobile)	min. 10 × outer diameter
Head A: Knurled nut material	Zinc-pressure die casting, surface Ni	Cable type	3
Head A: Body color	Black	Cable weight	approx. 66 g/m
Head A: Gasket material	FKM	Conductor structure	32 × 0,1 mm
Labeling sleeve side A	Yes	Cable diameter	7 mm ± 5%
Side B		Conductor: Material	Copper, bare
Head B: Connection	Open-ended wires	External sheath: Material	PUR
Labeling sleeve side B	Yes	Insulation: Material	PP
Cables		Shielding: Material	Copper, tinned
Cable length	500 cm	No. of bending cycles (C-track)	approx. 500000 Cycles
Length tolerance	± 7,5 cm	Nominal voltage	300 V
Stripping length	60 mm	No. of torsion cycles	approx. 2000000 Cycles
Shielded	Oui	Paired stranding	No
Conductor structure	32 × 0,1 mm	Single wire diameter	0,1 mm
AWG	24	Cable: Test voltage	2 kV AC core-core ; 2 kV AC core-shield
External sheath: Material	PUR	Torsion stress in °	± 30 °/m
External sheath: Color	Black	Total stranding	8 wires strand around core-filler
Cable diameter	7 mm ± 5%	Travel speed (C-track)	max. 3,3 m/s
Wire cross section	0,25 mm ²	Traversing path (horizontal)	max. 5 m
Cable		Wire cross section	0,25 mm ²
Cable: Temperature range (mobile)	- 25 ...+ 80 °C	Wire processing	No
Cable: Temperature range (fixed)	- 40 ...+ 80 °C	Wire diameter incl. isolation	1,2 mm ± 5%
Operating voltage (only UL listed)	30 V AC/DC	External sheath: Color	Black
Shielded	Oui	Données électriques	
Shielding: Covering	approx. 80 %	Operating voltage	max. 30 V AC/DC
Bending radius (fixed)	35 mm	Operating voltage (only UL listed)	30 V AC/DC
Number of wires	8	Nominal voltage	300 V
		Contact resistance	max. 30 mOhm

Caractéristiques techniques

Données électriques

Operating current per contact max. 2 A

Données mécaniques

Head A: Degree of protection IP65, IP66K, IP67
 Bending radius (mobile) min. 10 × outer diameter
 Bending radius (fixed) min. 5 × outer diameter
 No. of bending cycles (C-track) approx. 5000000 Cycles
 Torsion speed max. 35 cycles/min
 Torsion stress in ° ± 30 °/m
 No. of torsion cycles approx. 2000000 Cycles
 Acceleration (C-track) max. 5 m/s²
 Travel speed (C-track) max. 3,3 m/s

Conditions ambiantes

Temperature range (mobile) - 25 ...+ 80 °C
 Temperature range (fixed) - 25 ...+ 80 °C

Conditions ambiantes

Cable: Temperature range (fixed) - 40 ...+ 80 °C
 Dragchain capable Oui
 Head A: Chemical resistance No
 Head A: Flame resistance HB (UL 94)
 Head A: Oil resistance ASTM 1 oil, mineral oils, limited to hydraulic oils
 Head A: Acid and alkali resistant No
 Head A: Pollution degree 3
 Cable: Chemical resistance Good (DIN EN 60811-404)
 Cable: Flame resistance Conform UL 1581 §1090 (H), CSA FT2, IEC 60332-2-2
 Cable: Oil resistance Good (DIN EN 60811-404)
 Cable: Silicone-free Oui

Commercial data

Eclass 27060311

Side A

Technical drawing



Side B

Technical drawing

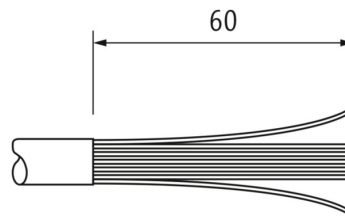

Coding



Schéma de raccordement



Dessin d'encombrement

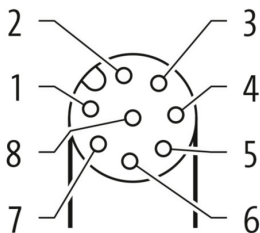
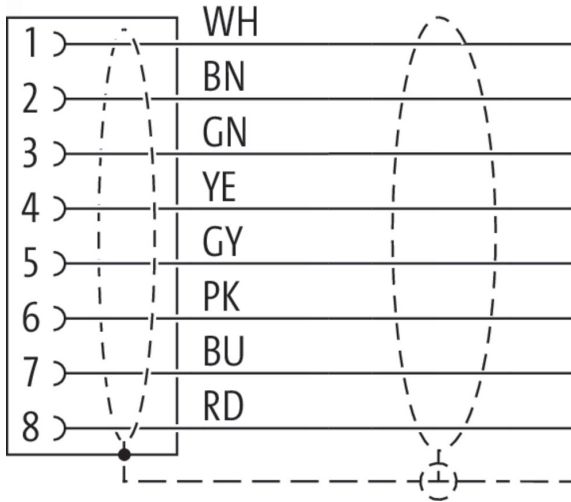