

Vue d'ensemble

- M12, female, A-coded; 5-poles; TPE-S, 2000 cm, shielded, free cable end
- Dragchain capable; suitable for robotics $\pm 180^\circ/\text{m}$; suitable for food & beverage
- Head A: IP65, IP68, IP69K
- ECOLAB tested
- Halogen free



Caractéristiques techniques

Side A		Cable	
Head A: Connection	M12	Number and diameter of wires	5x0,34
Head A: Angle cable outlet	90°	Length tolerance	± 30 cm
Head A: Gender	Female	Cable length	2000 cm
Head A: Coding	A	Acceleration (C-track)	max. 10 m/s ²
Head A: No. of poles	5	AWG	22
Head A: LED	No	Bending radius (fixed)	min. 5 × outer diameter
Head A: Width across flats	AF14	Torsion speed	max. 35 cycles/min
Head A: Tightening torque	0,6 Nm	Bending radius (mobile)	min. 10 × outer diameter
Head A: Knurled nut material	Stainless steel (V4A)	Cable weight	approx. 51,7 g/m
Head A: Body color	Blue	Conductor structure	42 × 0,1 mm
Head A: Gasket material	EPDM	Cable diameter	5,9 mm $\pm 5\%$
Labeling sleeve side A	No	Conductor: Material	Copper, bare
Side B		External sheath: Material	TPE-S
Head B: Connection	Open-ended wires	Insulation: Material	PP
Labeling sleeve side B	No	Shielding: Material	Copper, tinned
Cables		No. of bending cycles (C-track)	approx. 4000000 Cycles
Cable length	2000 cm	Nominal voltage	300 V AC
Length tolerance	± 30 cm	No. of torsion cycles	approx. 2000000 Cycles
Stripping length	20 mm	Paired stranding	No
Shielded	Oui	Single wire diameter	0,1 mm
Conductor structure	42 × 0,1 mm	Cable: Test voltage	3 kV
AWG	22	Torsion stress in °	$\pm 180^\circ/\text{m}$
External sheath: Material	TPE-S	Total stranding	5 wires strand around core-filler
External sheath: Color	Blue	Travel speed (C-track)	max. 3 m/s
Cable diameter	5,9 mm $\pm 5\%$	Traversing path (horizontal)	max. 10 m
Wire cross section	0,34 mm ²	Wire cross section	0,34 mm ²
Cable		Wire processing	No
Cable: Temperature range (mobile)	- 25 ...+ 105 °C	Wire diameter incl. isolation	1,27 mm $\pm 5\%$
Cable: Temperature range (fixed)	- 40 ...+ 105 °C	External sheath: Color	Blue
Operating voltage (only UL listed)	30 V AC/DC	Données électriques	
Shielded	Oui	Operating voltage	max. 60 V AC/DC
Shielding: Covering	approx. 85 %	Operating voltage (only UL listed)	30 V AC/DC
Bending radius (fixed)	29,5 mm	Nominal voltage	300 V AC
Number of wires	5	Contact resistance	max. 30 mOhm

Caractéristiques techniques

Données électriques

Operating current per contact max. 4 A

Données mécaniques

Head A: Degree of protection IP65, IP68, IP69K

Bending radius (mobile) min. 10 × outer diameter

Bending radius (fixed) min. 5 × outer diameter

No. of bending cycles (C-track) approx. 4000000 Cycles

Torsion speed max. 35 cycles/min

Torsion stress in ° ± 180 °/m

No. of torsion cycles approx. 2000000 Cycles

Acceleration (C-track) max. 10 m/s²

Travel speed (C-track) max. 3 m/s

Conditions ambiantes

Temperature range (mobile) - 25 ...+ 105 °C

Temperature range (fixed) - 40 ...+ 105 °C

Cable: Temperature range (fixed) - 40 ...+ 105 °C

Conditions ambiantes

Dragchain capable Oui

Head A: Chemical resistance Chemical resistance tested according to ECOLAB. If other media are used, the material resistance must be tested according to the application.

Head A: Flame resistance HB (UL 94)

Head A: Oil resistance ASTM 1 oil, mineral oils, limited to hydraulic oils

Head A: Acid and alkali resistant ECOLAB tested

Head A: Pollution degree 3

Cable: Chemical resistance ECOLAB material resistance test passed

Cable: Acid and alkali resistant Good (FDA 21 178.3620, 178.3297, 177.1520, EU 10/2011)

Cable: Silicone-free Oui

Commercial data

Eclass 27060311

Side A

Coding

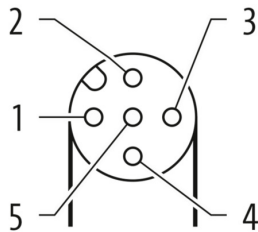

Side B

Technical drawing



Schéma de raccordement



Dessin d'encombrement

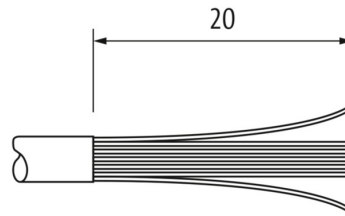
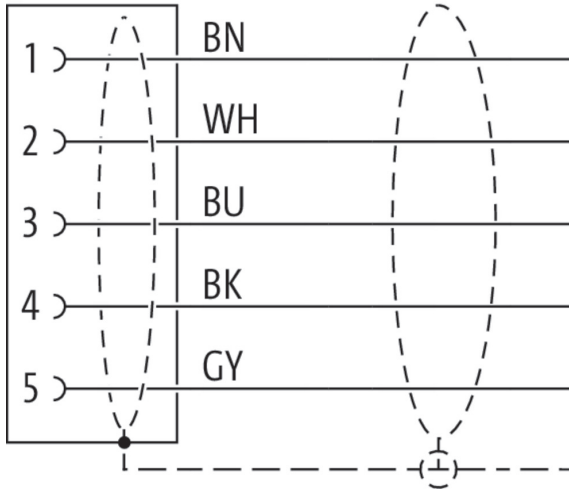