

**Vue d'ensemble**

- M12, male, A-coded; 4-poles; TPE-S, 300 cm, shielded, free cable end
- Dragchain capable; suitable for robotics  $\pm 180^\circ/\text{m}$ ; suitable for food & beverage
- Head A: IP65, IP68, IP69K
- ECOLAB tested
- Halogen free

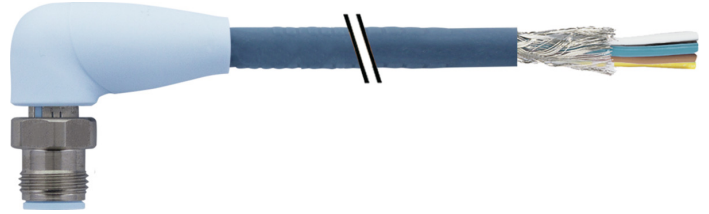

**Caractéristiques techniques**

Side A		Cable	
Head A: Connection	M12	Length tolerance	+ 10 cm
Head A: Angle cable outlet	90°	Cable length	300 cm
Head A: Gender	Male	Acceleration (C-track)	max. 10 m/s <sup>2</sup>
Head A: Coding	A	AWG	22
Head A: No. of poles	4	Bending radius (fixed)	min. 5 × outer diameter
Head A: LED	No	Torsion speed	max. 35 cycles/min
Head A: Width across flats	AF14	Bending radius (mobile)	min. 10 × outer diameter
Head A: Tightening torque	0,6 Nm	Cable weight	approx. 45,1 g/m
Head A: Knurled nut material	Stainless steel (V4A)	Conductor structure	42 × 0,1 mm
Head A: Body color	Blue	Cable diameter	5,6 mm ± 5%
Labeling sleeve side A	No	Conductor: Material	Copper, bare
<b>Side B</b>		External sheath: Material	TPE-S
Head B: Connection	Open-ended wires	Insulation: Material	PP
Labeling sleeve side B	No	Shielding: Material	Copper, tinned
<b>Cables</b>		No. of bending cycles (C-track)	approx. 4000000 Cycles
Cable length	300 cm	Nominal voltage	300 V AC
Length tolerance	+ 10 cm	No. of torsion cycles	approx. 2000000 Cycles
Stripping length	20 mm	Paired stranding	No
Shielded	Oui	Single wire diameter	0,1 mm
Conductor structure	42 × 0,1 mm	Cable: Test voltage	3 kV
AWG	22	Torsion stress in °	± 180 °/m
External sheath: Material	TPE-S	Total stranding	4 wires strand
External sheath: Color	Blue	Travel speed (C-track)	max. 3 m/s
Cable diameter	5,6 mm ± 5%	Traversing path (horizontal)	max. 10 m
Wire cross section	0,34 mm <sup>2</sup>	Wire cross section	0,34 mm <sup>2</sup>
<b>Cable</b>		Wire processing	No
Cable: Temperature range (mobile)	- 25 ...+ 105 °C	Wire diameter incl. isolation	1,27 mm ± 5%
Cable: Temperature range (fixed)	- 40 ...+ 105 °C	External sheath: Color	Blue
Operating voltage (only UL listed)	30 V AC/DC	<b>Données électriques</b>	
Shielded	Oui	Operating voltage	max. 60 V AC/DC
Shielding: Covering	approx. 85 %	Operating voltage (only UL listed)	30 V AC/DC
Bending radius (fixed)	28 mm	Nominal voltage	300 V AC
Number of wires	4	Contact resistance	max. 30 mOhm
Number and diameter of wires	4x0,34	Operating current per contact	max. 4 A

**Caractéristiques techniques**

**Données mécaniques**

Head A: Degree of protection	IP65, IP68, IP69K
Bending radius (mobile)	min. 10 × outer diameter
Bending radius (fixed)	min. 5 × outer diameter
No. of bending cycles (C-track)	approx. 4000000 Cycles
Torsion speed	max. 35 cycles/min
Torsion stress in °	± 180 °/m
No. of torsion cycles	approx. 2000000 Cycles
Acceleration (C-track)	max. 10 m/s <sup>2</sup>
Travel speed (C-track)	max. 3 m/s

**Conditions ambiantes**

Temperature range (mobile)	- 25 ...+ 105 °C
Temperature range (fixed)	- 40 ...+ 105 °C
Cable: Temperature range (fixed)	- 40 ...+ 105 °C

**Conditions ambiantes**

Dragchain capable	Oui
Head A: Chemical resistance	Chemical resistance tested according to ECOLAB. If other media are used, the material resistance must be tested according to the application.
Head A: Flame resistance	HB (UL 94)
Head A: Oil resistance	ASTM 1 oil, mineral oils, limited to hydraulic oils
Head A: Acid and alkali resistant	ECOLAB tested
Head A: Pollution degree	3
Cable: Chemical resistance	ECOLAB material resistance test passed
Cable: Acid and alkali resistant	Good (FDA 21 178.3620, 178.3297, 177.1520, EU 10/2011)
Cable: Silicone-free	Oui

**Commercial data**

Eclass	27060311
--------	----------

**Side A**

**Technical drawing**

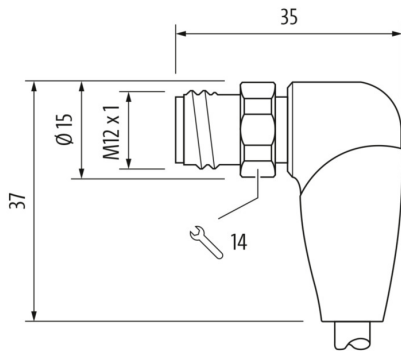

**Side B**

**Technical drawing**

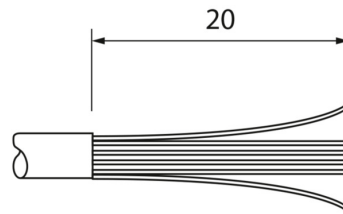

**Coding**

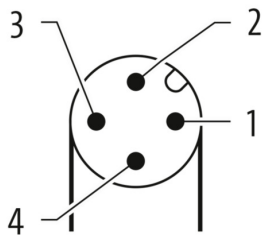

**Schéma de raccordement**

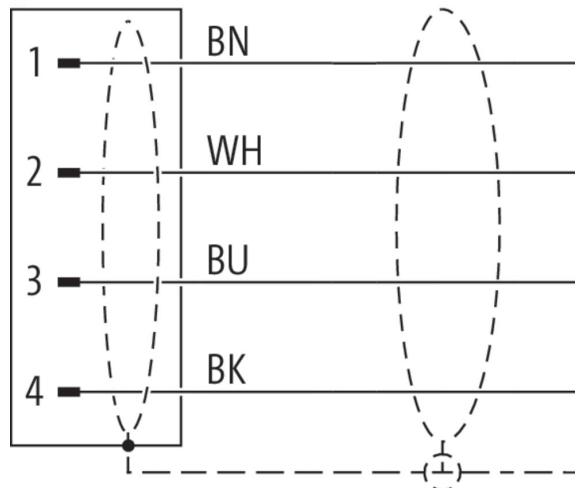

Dessin d'encombrement

