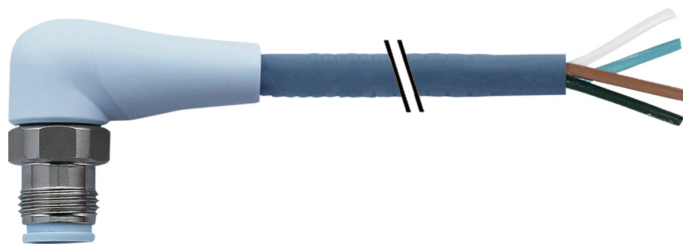

Vue d'ensemble

- M12, male, A-coded; 4-poles; TPE-S, 2500 cm, free cable end
- Dragchain capable; suitable for robotics $\pm 180^\circ/\text{m}$; suitable for food & beverage
- Head A: IP65, IP68, IP69K
- ECOLAB tested
- Halogen free

Caractéristiques techniques

Side A		Cable	
Head A: Connection	M12	Cable length	2500 cm
Head A: Angle cable outlet	90°	Acceleration (C-track)	max. 10 m/s ²
Head A: Gender	Male	AWG	22
Head A: Coding	A	Bending radius (fixed)	min. 5 × outer diameter
Head A: No. of poles	4	Torsion speed	max. 35 cycles/min
Head A: LED	No	Bending radius (mobile)	min. 10 × outer diameter
Head A: Width across flats	AF14	Cable weight	approx. 29,7 g/m
Head A: Tightening torque	0,6 Nm	Conductor structure	42 × 0,1 mm
Head A: Knurled nut material	Stainless steel (V4A)	Cable diameter	4,7 mm ± 5%
Head A: Body color	Blue	Conductor: Material	Copper, bare
Labeling sleeve side A	No	External sheath: Material	TPE-S
Side B		Insulation: Material	PP
Head B: Connection	Open-ended wires	No. of bending cycles (C-track)	approx. 4000000 Cycles
Labeling sleeve side B	No	Nominal voltage	300 V AC
Cables		No. of torsion cycles	approx. 2000000 Cycles
Cable length	2500 cm	Paired stranding	No
Length tolerance	± 37,5 cm	Single wire diameter	0,1 mm
Stripping length	20 mm	Cable: Test voltage	3 kV
Shielded	No	Torsion stress in °	± 180 °/m
Conductor structure	42 × 0,1 mm	Total stranding	4 wires strand
AWG	22	Travel speed (C-track)	max. 3 m/s
External sheath: Material	TPE-S	Traversing path (horizontal)	max. 10 m
External sheath: Color	Blue	Wire cross section	0,34 mm ²
Cable diameter	4,7 mm ± 5%	Wire processing	No
Wire cross section	0,34 mm ²	Wire diameter incl. isolation	1,27 mm ± 5%
Cable		External sheath: Color	Blue
Cable: Temperature range (mobile)	- 25 ...+ 105 °C	Données électriques	
Cable: Temperature range (fixed)	- 40 ...+ 105 °C	Operating voltage	max. 250 V AC/DC
Operating voltage (only UL listed)	30 V AC/DC	Operating voltage (only UL listed)	30 V AC/DC
Shielded	No	Nominal voltage	300 V AC
Bending radius (fixed)	23,5 mm	Contact resistance	max. 30 mOhm
Number of wires	4	Operating current per contact	max. 4 A
Number and diameter of wires	4x0,34	Données mécaniques	
Length tolerance	± 37,5 cm	Head A: Degree of protection	IP65, IP68, IP69K
		Bending radius (mobile)	min. 10 × outer diameter

Caractéristiques techniques

Données mécaniques

Bending radius (fixed)	min. 5 × outer diameter
No. of bending cycles (C-track)	approx. 4000000 Cycles
Torsion speed	max. 35 cycles/min
Torsion stress in °	± 180 °/m
No. of torsion cycles	approx. 2000000 Cycles
Acceleration (C-track)	max. 10 m/s ²
Travel speed (C-track)	max. 3 m/s

Conditions ambiantes

Temperature range (mobile)	- 25 ...+ 105 °C
Temperature range (fixed)	- 40 ...+ 105 °C
Cable: Temperature range (fixed)	- 40 ...+ 105 °C
Dragchain capable	Oui
Head A: Chemical resistance	Chemical resistance tested according to ECOLAB. If other media are used, the material resistance must be tested according to the application.

Conditions ambiantes

Head A: Flame resistance	HB (UL 94)
Head A: Oil resistance	ASTM 1 oil, mineral oils, limited to hydraulic oils
Head A: Acid and alkali resistant	ECOLAB tested
Head A: Pollution degree	3
Cable: Chemical resistance	ECOLAB material resistance test passed
Cable: Acid and alkali resistant	Good (FDA 21 178.3620, 178.3297, 177.1520, EU 10/2011)
Cable: Silicone-free	Oui

Commercial data

Eclass	27060311
--------	----------

Side A

Technical drawing

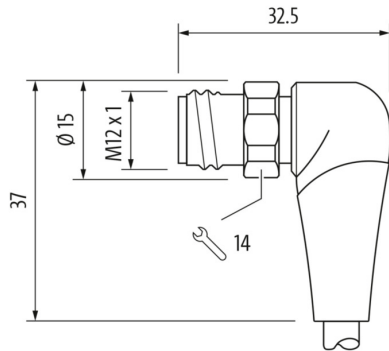

Side A

Coding

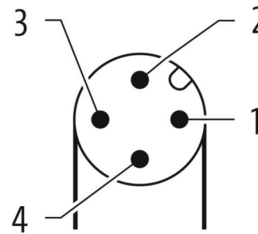

Side B

Technical drawing



Schéma de raccordement



Dessin d'encombrement

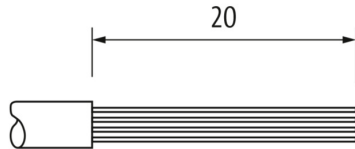
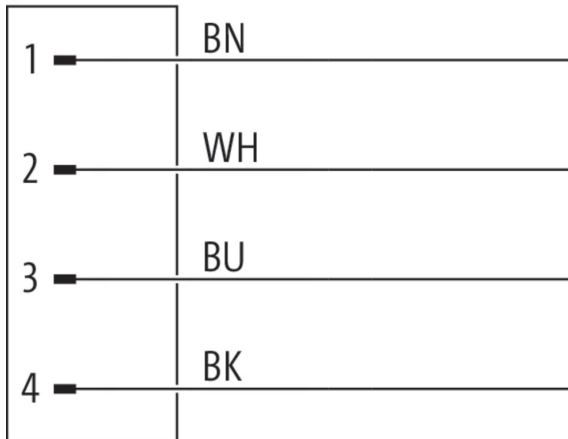