

Vue d'ensemble

- M12, male, A-coded, 3-poles; PUR, 200 cm; M8, female, A-coded, 3-poles
- Dragchain capable; suitable for robotics $\pm 180^\circ/\text{m}$
- Head A: IP65, IP66K, IP67; Head B: IP65, IP66K, IP67
- Cable: good resistance against chemicals, flames, oils
- Halogen free

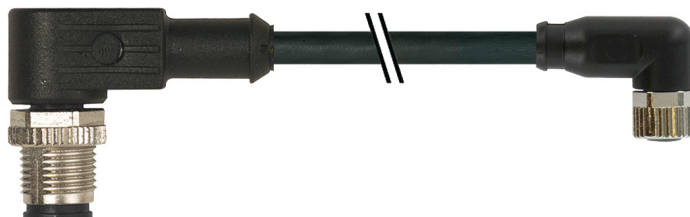

Caractéristiques techniques

Side A		Cable	
Head A: Connection	M12	Cable: Temperature range (fixed)	- 40 ...+ 80 °C
Head A: Angle cable outlet	90°	Operating voltage (only UL listed)	30 V AC/DC
Head A: Gender	Male	Shielded	No
Head A: Coding	A	Bending radius (fixed)	20,5 mm
Head A: No. of poles	3	Number of wires	3
Head A: LED	No	Number and diameter of wires	3x0,25
Head A: Width across flats	AF13	Length tolerance	+ 10 cm
Head A: Tightening torque	0,6 Nm	Cable length	200 cm
Head A: Knurled nut material	Zinc-pressure die casting, surface Ni	Acceleration (C-track)	max. 10 m/s ²
Head A: Body color	Black	AWG	24
Labeling sleeve side A	Yes	Bending radius (fixed)	min. 5 × outer diameter
Side B		Torsion speed	max. 35 cycles/min
Head B: Connection	M8	Bending radius (mobile)	min. 10 × outer diameter
Head B: Angle cable outlet	90°	Cable type	3
Head B: Gender	Female	Cable weight	approx. 26,4 g/m
Head B: Coding	A	Conductor structure	32 × 0,1 mm
Head B: No. of poles	3	Cable diameter	4,1 mm ± 5%
Head B: LED	No	Conductor: Material	Copper, bare
Head B: Width across flats	AF9	External sheath: Material	PUR
Head B: Tightening torque	0,4 Nm	Insulation: Material	PP
Head B: Knurled nut material	Zinc-pressure die casting, surface Ni	No. of bending cycles (C-track)	approx. 10000000 Cycles
Head B: Body color	Black	Nominal voltage	300 V
Head B: Gasket material	FKM	No. of torsion cycles	approx. 2000000 Cycles
Labeling sleeve side B	Yes	Paired stranding	No
Cables		Single wire diameter	0,1 mm
Cable length	200 cm	Cable: Test voltage	2,5 kV
Length tolerance	+ 10 cm	Torsion stress in °	± 180 °/m
Shielded	No	Total stranding	3 wires strand
Conductor structure	32 × 0,1 mm	Travel speed (C-track)	max. 3 m/s
AWG	24	Traversing path (horizontal)	max. 10 m
External sheath: Material	PUR	Wire cross section	0,25 mm ²
External sheath: Color	Black	Wire processing	No
Cable diameter	4,1 mm ± 5%	Wire diameter incl. isolation	1,25 mm ± 5%
Wire cross section	0,25 mm ²	External sheath: Color	Black
Cable			
Cable: Temperature range (mobile)	- 25 ...+ 80 °C		

2024-06-25 Les caractéristiques du produit et les données techniques spécifiées n'impliquent aucune garantie. Toute modification technique réservée.

Caractéristiques techniques

Données électriques

Operating voltage	max. 50 V AC / 60 V DC
Operating voltage (only UL listed)	30 V AC/DC
Nominal voltage	300 V
Contact resistance	max. 30 mOhm
Operating current per contact	max. 4 A

Données mécaniques

Head A: Degree of protection	IP65, IP66K, IP67
Head B: Degree of protection	IP65, IP66K, IP67
Bending radius (mobile)	min. 10 × outer diameter
Bending radius (fixed)	min. 5 × outer diameter
No. of bending cycles (C-track)	approx. 10000000 Cycles
Torsion speed	max. 35 cycles/min
Torsion stress in °	± 180 °/m
No. of torsion cycles	approx. 2000000 Cycles
Acceleration (C-track)	max. 10 m/s ²
Travel speed (C-track)	max. 3 m/s

Conditions ambiantes

Temperature range (mobile)	- 25 ...+ 80 °C
Temperature range (fixed)	- 25 ...+ 80 °C

Conditions ambiantes

Cable: Temperature range (fixed)	- 40 ...+ 80 °C
Dragchain capable	Oui
Head A: Chemical resistance	No
Head A: Flame resistance	HB (UL 94)
Head A: Oil resistance	ASTM 1 oil, mineral oils, limited to hydraulic oils
Head A: Acid and alkali resistant	No
Head A: Pollution degree	3
Head B: Chemical resistance	No
Head B: Flame resistance	HB (UL 94)
Head B: Oil resistance	ASTM 1 oil, mineral oils, limited to hydraulic oils
Head B: Acid and alkali resistant	No
Head B: Pollution degree	3
Cable: Chemical resistance	Good (DIN EN 60811-404)
Cable: Flame resistance	Conform UL 1581 §1090 (H), CSA FT2, IEC 60332-2-2
Cable: Oil resistance	Good (DIN EN 60811-404)
Cable: Silicone-free	Oui

Commercial data

Eclass	27060311
--------	----------

Side A

Technical drawing

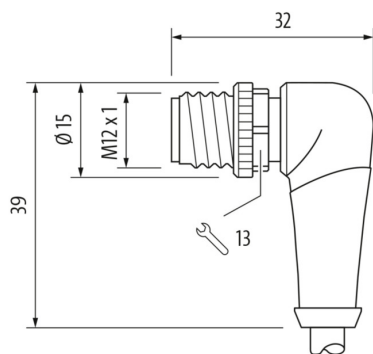

Side A

Coding

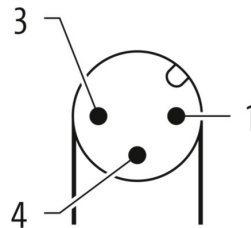

Side B

Technical drawing

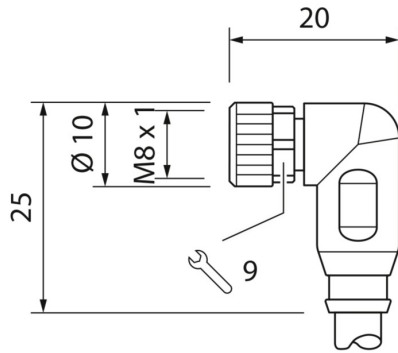

Dessin d'encombrement



Coding

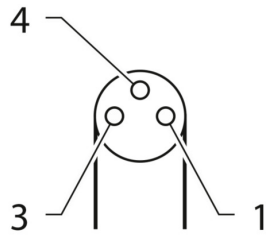

Schéma de raccordement

