

# AFI4 (2 x 4...20 mA, IO-Link)

AFI4-###0.#0#6.1###

## Overview

- All-in-One conductivity sensor
- All wetted parts in PEEK
- Compact, food-safe, hygienic design
- 3-A sanitary standards and FDA-compliant, EHEDG-certified
- IO-Link communication interface
- Dual Channel - analog and digital interface in a single sensor



## Technical data

### Performance characteristics conductivity

Conductivity	14 selectable ranges
Min. measurable conductivity	50 µS/cm
Measuring ranges (selectable)	0 ... 500 µS/cm 0 ... 1 mS/cm 0 ... 2 mS/cm 0 ... 3 mS/cm 0 ... 5 mS/cm 0 ... 10 mS/cm 0 ... 20 mS/cm 0 ... 30 mS/cm 0 ... 50 mS/cm 0 ... 100 mS/cm 0 ... 200 mS/cm 0 ... 300 mS/cm 0 ... 500 mS/cm 0 ... 1000 mS/cm
Max. measuring span	1000 mS/cm
Min. measuring span	500 µS/cm
Max. measuring error	± 1.0 % FSR , 0 ... 1 mS/cm to 0 ... 500 mS/cm ± 1.5 % FSR , 0 ... 1000 mS/cm ± 1.5 % FSR , 0 ... 500 µS/cm
Reference conditions for max. measuring error	Sensor incl. transmitter @ 25°C ambient temperature
Reference temperature	25 °C , adjustable
Repeatability	< 0.5 % FSR , > 1 mS/cm
Compensated temperature range	-20 ... 150 °C
Temperature compensation	0.0 ... 5.0 % FSR/K , adjustable
Step response time, T90	≤ 2.0 s
Sample time	≤ 0.4 s

### Performance characteristics conductivity

Temperature drift (Factor of change in process temperature from 25°C)	≤ 0.1 % FSR/K
Temperature drift (Factor of change in process temperature from 25°C) (0 ... 500 µS / cm)	≤ 0.3 % FSR/K
<b>Performance characteristics concentration</b>	
Concentration	Programmable with IO-Link and FlexProgram
Factory set media (available from FlexProgram)	0 ... 25 % by weight , HNO3 (nitric acid) 36 ... 82 % by weight , HNO3 (nitric acid) 0 ... 12 % by weight , NaOH (caustic soda) 25 ... 50 % by weight , NaOH (caustic soda)
Customer defined media	Customer defined (30 point lookup table)

### Performance characteristics temperature

Temperature	Free programmable range
Measuring range	-20 ... 150 °C
Thermal response time, T90	≤ 15 s
Max. measuring error	± 1.5 K 0.3 K , 20 ... 50 °C
Reference conditions for max. measuring error	Sensor incl. transmitter @ 25°C ambient temperature
Temperature coefficient (Factor of change in process temperature from 25°C)	≤ 0.05 % FSR/K

# AFI4 (2 x 4...20 mA, IO-Link)

AFI4-###0.#0#6.1###

## Technical data

### Process conditions

Process temperature	-20 ... 140 °C , permanent 140 ... 150 °C , max. t < 1 h
Process pressure	≤ 25 bar
SIP/CIP compatibility	< 60 min, @ medium temperature up to 150 °C

### Process connection

Connection variants	G 1 A hygienic
Immersion length	Refer to section "Dimensional drawings"
Wetted parts material	PEEK Natura
Surface roughness wetted parts	Ra ≤ 0.8 µm

### Ambient conditions

Operating temperature range	-30 ... 80 °C , with DFON touch screen -40 ... 85 °C , without DFON touch screen
Degree of protection (EN 60529)	IP67 IP69K , with appropriate cable
Humidity	< 98 % RH , condensing
Insulation voltage	500 V AC
Vibration (sinusoidal) (EN 60068-2-6)	1.0 mm p-p (2 ... 13.2 Hz), 0.7 g (13.2 ... 100 Hz), 1 octave / min.

### Output signal

Conductivity/Concentration	4 ... 20 mA
Temperature	4 ... 20 mA
Relays	2 relays included in the display
Current rating	100 mA , max.
Interface	IO-Link 1.1 With FlexProgrammer 9701

### IO-Link interface

IO-Link version	1.1
Device profile	Smart Sensor Profile
IO-Link port type	Class A
Baud rate	38,4 kbaud (COM2)
Cycle time	≥ 8.4 ms
Process data length	128 bit
SIO-mode	Yes
Process data (cyclic)	Switch state Signal analog output 1 Signal analog output 2 Temperature Unit temperature Conductivity Concentration Actual measuring range
Adjustable data (acyclic)	Measuring mode Sensor calibration Media calibration Reference temperature Temperature compensation Switch parameters

### IO-Link interface

Dual Channel	Conductivity/Concentration
Dual Channel 2	Temperature
Dual Channel 3	Relay 1
Dual Channel 4	Relay 2

### Housing

Style	FlexHousing, Ø80 mm Bottom process connection Rear process connection
Overall size	Refer to section "Dimensional drawings"
Material	AISI 304 (1.4301)

### Electrical connection

Connector (available for left side)	M12-A, 5-pin, stainless steel M16x1.5, plastic M16x1.5, stainless steel M20x1.5, plastic M20x1.5, stainless steel
Connector (available for right side)	M16x1.5, plastic M16x1.5, stainless steel M20x1.5, plastic M20x1.5, stainless steel M12-A, 4-pin, stainless steel, 4 ... 20 mA output M12-A, 8-pin, stainless steel, 4 ... 20 mA + relay output

### Power supply

Voltage supply range	15 ... 35 V DC 18 ... 30 V DC , with IO-Link
Current consumption (no load)	150 mA , max.
Power-up time	≤ 10 s , without DFON touch screen ≤ 16 s , with DFON touch screen

### Factory settings

Output mode	Conductivity
Conductivity Range 1	0 ... 200 mS/cm
Conductivity Range 2	0 ... 20 mS/cm
Conductivity Range 3	0 ... 2 mS/cm
Conductivity Range 4	0 ... 500 µS/cm
Temperature output	0 ... 150 °C
Output damping	0.00 s
Temperature compensation Range 1-4	2.00 % FSR/K
Output lower limit	3.70 mA
Output upper limit	21.00 mA

### Compliance and approvals

EMC	EN 61326-1
Hygiene	3-A (74-07) EHEDG EL Class I FDA (21 CFR 177.2415)
Safety	cULus listed, E491206

# AFI4 (2 x 4...20 mA, IO-Link)

AFI4-###0.#0#6.1###

## Operating conditions

Measuring range	Max. measuring error	Conductivity	Media group	Media
0 ... 500 µS/cm	1,5 % FSR	7,5 µS/cm		Ultra-pure water
0 ... 1 mS/cm	1,0 % FSR	10 µS/cm	Water	Pure water
0 ... 2 mS/cm	1,0 % FSR	20 µS/cm		Process water
0 ... 3 mS/cm	1,0 % FSR	30 µS/cm		Drinking water
0 ... 5 mS/cm	1,0 % FSR	50 µS/cm		Beer
0 ... 10 mS/cm	1,0 % FSR	100 µS/cm	Food & Beverage	Milk
0 ... 20 mS/cm	1,0 % FSR	200 µS/cm		Orange juice
0 ... 30 mS/cm	1,0 % FSR	300 µS/cm		Apple juice
0 ... 50 mS/cm	1,0 % FSR	500 µS/cm		Phosphoric acid
0 ... 100 mS/cm	1,0 % FSR	1 mS/cm	Process	Hydrochloric acid
0 ... 200 mS/cm	1,0 % FSR	2 mS/cm		Sodium hydroxide
0 ... 300 mS/cm	1,0 % FSR	3 mS/cm		
0 ... 500 mS/cm	1,0 % FSR	5 mS/cm		
0 ... 1000 mS/cm	1,5 % FSR	15 mS/cm		

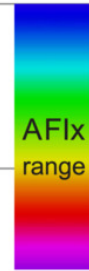

## Display

### General information

Panel type	FSTN Graphical LCD
Display range	-9999 ... 99999
Max. digit height	22 mm
Material	Polycarbonate

### Ambient conditions

Operating temperature range	-30 ... 80 °C
Optimal readability temperature range	-10 ... 70 °C
Degree of protection (EN 60529)	IP 67 IP 69 K

### Input signal

Input signal from transmitter	Digital, 2-way for communication between transmitter and display
Update time	≤ 1 s, max. 0.3 s, typ.

### User configurable data

Error- / Warning-indication	Individually configurable display and backlight indication in white, green or red colour, steady or flashing light. Configurable limits over the range
Media description	Customer programmable e.g. "MILK", "Water", "NaOH"
Measuring unit	µS/cm mS/cm % °C °F
User defined measuring unit	8 × 20 pixel matrix

### Relays

Contacts	2 x solid state relays
Max. load current	75 mA
Max. switching voltage	60 V

## Selectable display views

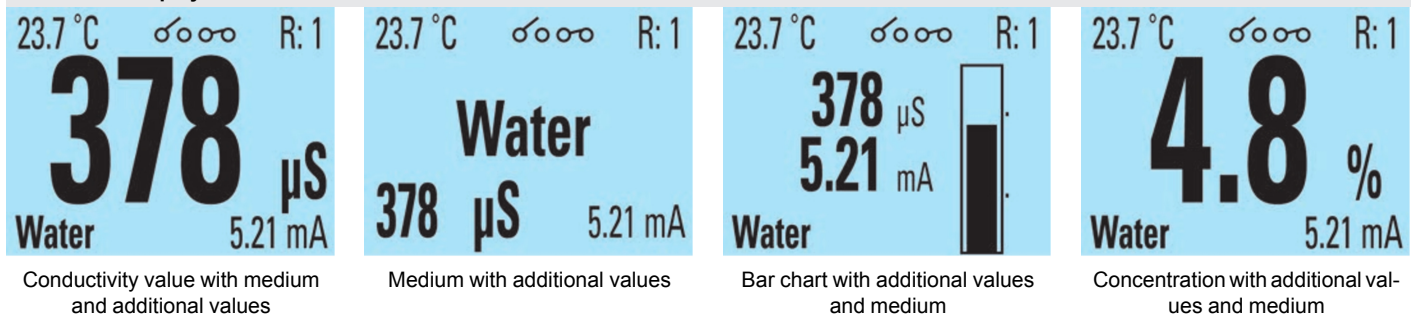

Conductivity value with medium and additional values

Medium with additional values

Bar chart with additional values and medium

Concentration with additional values and medium

# AFI4 (2 x 4...20 mA, IO-Link)

AFI4-###0.#0#6.1###

## Display

### Selectable display views

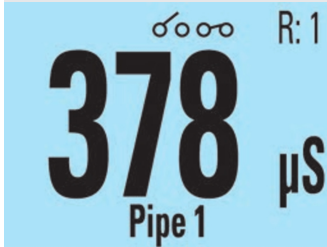

Conductivity value with measuring point (TAG)

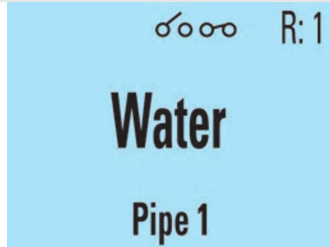

Medium with measuring point (TAG)

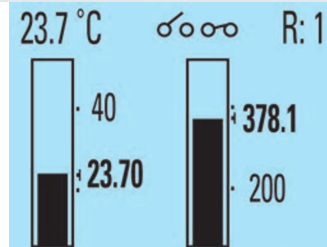

Bar chart including temperature

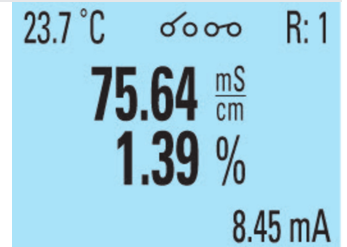

Conductivity and concentration value



White background



Green background



Red background



Exemplary error message

## Dimensional drawings (mm)

### Housing



FlexHousing, available with or without DFON touchscreen

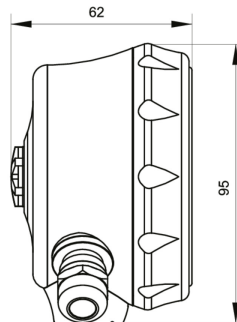

FlexHousing with bottom process connection

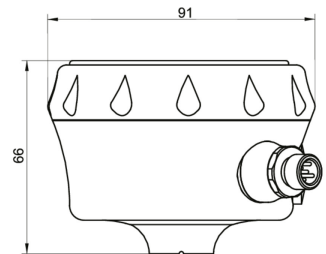

FlexHousing with rear process connection

**Dimensional drawings (mm)**

**Process connection**

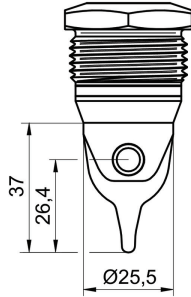

G 1 A hygienic (BCID: A04), PEEK, 37 mm

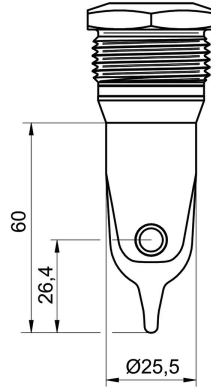

G 1 A hygienic (BCID: A04), PEEK, 60 mm

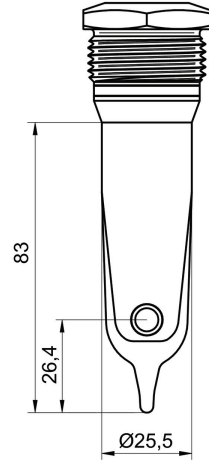

G 1 A hygienic (BCID: A04), PEEK, 83 mm

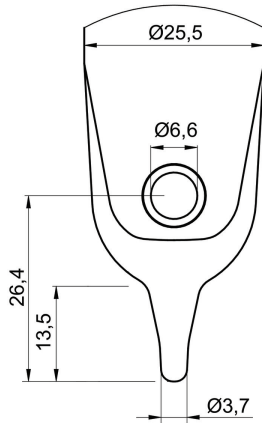

Sensor tip with integrated Pt100 sensor element



# AFI4 (2 x 4...20 mA, IO-Link)

AFI4-###0.#0#6.1###

## Electrical connection

### M12-A, 5-pin

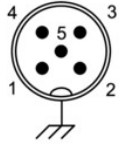

Left side connection

Right side connection

### M12-A, 4-pin

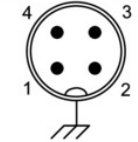

### M12-A, 8-pin

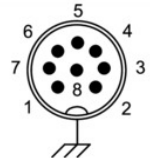

### Left side connection (front view): M12-A, 5-pin

Function			Pin assignment
+Vs	Power supply +	15 ... 35 V DC	1
GND (0 V)	Power supply -	15 ... 35 V DC	3
lout1+	Conductivity +	4 ... 20 mA	5
lout-	Conductivity -	4 ... 20 mA	2
IO-Link	IO-Link / SW		4

lout- is internally connected as common for both Conductivity/Concentration and Temperature output.

### Left side connection (front view): Cable gland

Function			Recommended wiring
+Vs	Power supply +	15 ... 35 V DC	BN
GND (0 V)	Power supply -	15 ... 35 V DC	BU
lout1+	Conductivity +	4 ... 20 mA	GY
lout-	Conductivity -	4 ... 20 mA	WH
IO-Link	IO-Link / SW		BK

lout- is internally connected as common for both Conductivity/Concentration and Temperature output.

### Right side connection (front view): M12-A, 4-pin

Function			Pin assignment
lout2+	Temperature +	4 ... 20 mA	4
lout-	Temperature -	4 ... 20 mA	2
S1	External input	n.c. / 24 V DC	1
S2	External input	n.c. / 24 V DC	3

lout- is internally connected as common for both Conductivity/Concentration and Temperature output.

### Right side connection (front view): M12-A, 8-pin

Function			Pin assignment
lout2+	Temperature +	4 ... 20 mA	2
lout-	Temperature -	4 ... 20 mA	7
S1	External input	n.c. / 24 V DC	1
S2	External input	n.c. / 24 V DC	8
R11	Relay 1		5
R12	Relay 1		6
R21	Relay 2		3
R22	Relay 2		4

lout- is internally connected as common for both Conductivity/Concentration and Temperature output.

### Right side connection (front view): Cable gland

Function			Recommended wiring
lout2+	Temperature +	4 ... 20 mA	BN
lout-	Temperature -	4 ... 20 mA	BU
S1	External input	n.c. / 24 V DC	WH
S2	External input	n.c. / 24 V DC	RD
R11	Relay 1		GY
R12	Relay 1		PK
R21	Relay 2		GN
R22	Relay 2		YE

lout- is internally connected as common for both Conductivity/Concentration and Temperature output.

# AFI4 (2 x 4...20 mA, IO-Link)

AFI4-###0.#0#6.1###

## Electrical connection

### Terminal assignment transmitter

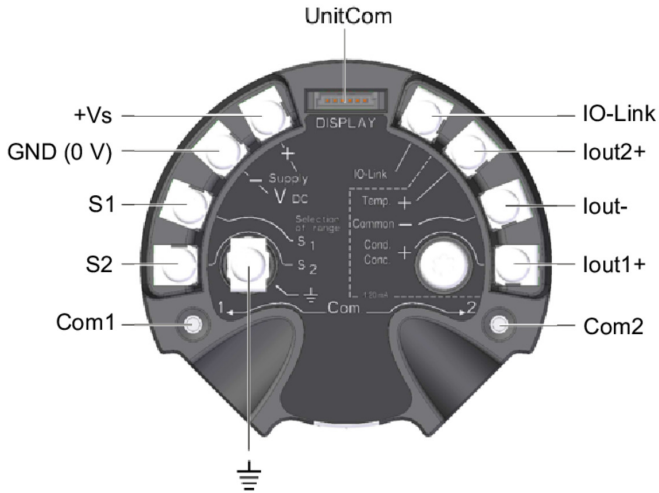

### Terminal assignment DFON display

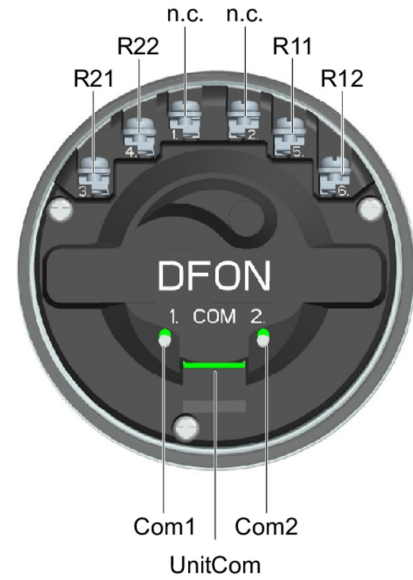

The ground connection is to be connected with the cable shield if using cable gland and shielded cable.

### Equivalent circuit diagram

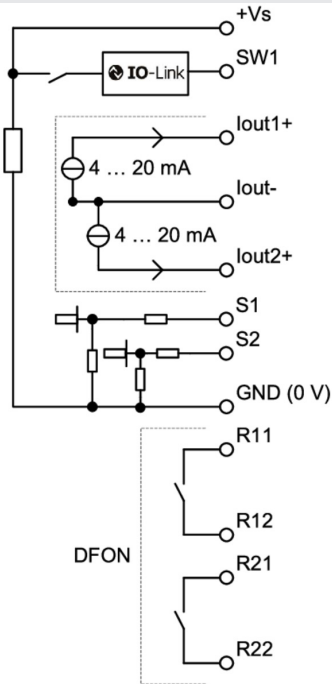

# AFI4 (2 x 4...20 mA, IO-Link)

AFI4-###0.#0#6.1###

## Ordering information

Ordering key - Configuration possibilities see website

	AFI	4	-	#	#	#	0	.	#	0	#	6	.	1	#	#	#
<b>Product</b>	AFI																
<b>Type</b>																	
Compact version		4															
<b>Housing</b>																	
Bottom process connection																	5
Rear process connection																	6
<b>Electrical connection</b>																	
2 x M16x1.5 cable gland																	8
1 x M16x1.5 + 1 x M20x1.5 cable gland																	A
2 x M20x1.5 cable gland																	B
1 x M12-A, 5-pin + 1 x M12-A, 4-pin																	C
1 x M12-A, 5-pin + 1 x M12-A, 8-pin																	D
<b>Material of el. connection</b>																	
Plastic																	1
Stainless steel, AISI 304 (1.4301)																	3
<b>Cable length (cm)</b>																	
No cable, compact version																	0
<b>Display</b>																	
Without display																	1
With display, with activated relays																	4
<b>Safety</b>																	
Standard																	0
<b>Configuration</b>																	
No configuration																	0
Configuration of range																	1
Configuration of range + display incl. 2 relays																	3
<b>Output</b>																	
2 x 4...20 mA, IO-Link																	6
<b>Version</b>																	
IO-Link																	1
<b>Process connection</b>																	
G 1 A hygienic, PEEK, length: 37 mm. (A04)																	1
G 1 A hygienic, PEEK, length: 83 mm. (A04)																	2
G 1 A hygienic, PEEK, length: 60 mm. (A04)																	3
<b>Approvals</b>																	
Standard approvals																	0
3-A / EHEDG																	1
<b>Calibration certificate</b>																	
No																	0
Calibration certificate, conductivity (5 points)																	1
Calibration certificate, temperature. (3 points)																	2
Calibration certificate, conductivity (5 points) and temperature (3 points)																	3